KATALOG REZERVNIH DELOVA ZA KOMERCIJALNA VOZILA



MAN
2015



ISO 9001:2008
valid until:
04.09.2016.
www.tuv.com
ID: 9105043178

KATALOG REZERVNIH DELOVA ZA KOMERCIJALNA VOZILA



www.rapidex.co.rs

MAN
2015





NOVI SAD

Novosadski put 160
21000 Novi Sad
Srbija

Tel./Fax.

021 651 0521
021 651 0522
021 651 0523
021 651 1228
021 651 2254
060 824 8801

e mail: office@rapidex.co.rs



BEOGRAD

Milošev kladenac BB

Tel/fax.

011 406 59 48
011 406 67 82
011 406 67 83
060 824 8804

BATAJNICA

Majora Zorana
Radosavljevića 259

Tel/fax.

011 406 56 82
060 824 8816





PARAĆIN

Carice Milice 54

Tel/fax
035 8 567 611
035 8 567 671
060 824 8833



ČAČAK

Konjevići bb

Tel.
032 559 0037
060 824 8821



LOZNICA

Bulevar Dositeja Obradovića 70

Tel.
015 877 883
015 877 884
060 824 8810

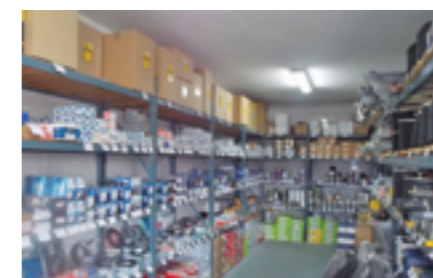

SOMBOR

XII Vojvodanske udarne
brigade 130

Tel.
025 461 481
060 824 8850



NOVI PAZAR

Save Kovačevića 300

Tel.
020 315 156,
060 824 8824



SUBOTICA

Beogradski put 21

Tel.
024 556 246
060 824 8862

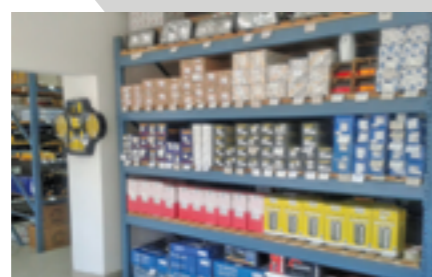

VRANJE

Ivana Meštrovića 27

Tel.
017 410 088
060 824 8835



VRBAS

Ivana Milutinovića 11

Tel.
021 700 087
060 824 8806



SADRŽAJ:

1.0 MOTOR

1.1	Delovi motora	14
1.2	Pumpe vode, ulja i upravljača	22
1.3	Termostati	26
1.4	Španeri motora i prenosni kaiševi	27
1.5	Turbo kompresori	30
1.6	Hlađenje motora (Visko ventilatori, hladnjaci, interkuleri, ekspanzione posude i hladnjaci ulja)	30
1.7	Hlađenje i grejanje kabine (Hladnjaci klime, kompresori klime i izmenjivači toplote).....	33
1.8	Creva vode i interkulera	34
1.9	Filteri	37
1.10	Napajanje gorivom	40
1.11	Davači i senzori	44
1.12	Izduvni sistemi	50

2.0 KVAČILO I TRANSMISIJA

2.1	Setovi kvačila i elementi	56
2.2	Centralni ležajevi kardana	61
2.3	Cilindri menjača	62

3.0 KOČIONA PNEUMATIKA I HIDRAULIKA

3.1	Kompresori i delovi	66
3.2	Isušivači vazduha i filteri	67
3.3	Ventili kočionog sistema	70
3.4	Ventili ogibljenja	81
3.5	Cilindri tristop i membranski	82
3.6	Ventili ABS, EBS i ECAS	84
3.7	Elektronika ECAS	89
3.8	Senzori	90
3.9	Cilindri kvačila	93
3.10	Pribor kočionog sistema	97
3.11	WABCO I WABCOWÜRTH dijagnostika	105

4.0 KOMPONENTE KOČIONOG SISTEMA

4.1	Disk kočnica	114
4.2	Kočione pločice	117
4.3	Čeljusti kočnica	120
4.4	Doboši kočnica	121
4.5	Kočione obloge	122
4.6	Šteleri kočnica	124
4.7	Glavčine točka, ležajevi i semerinzi	126
4.8	Vijci i navrtke	129

5.0 ELEMENTI OGIBLJENJA I UPRAVLJANJA

5.1	Amortizeri	132
5.2	Vazdušni jastuci	136
5.3	Gibnjevi	140
5.4	Delovi stabilizatora	145
5.5	Delovi rukavca	149
5.6	Spone i delovi spona	151
5.7	Uporne spone	156
5.8	V spone	157

6.0 KABINA I DELOVI KABINE

6.1	Delovi kabine	160
6.2	Ogledala i delovi ogledala	184
6.3	Cilindri i pumpe za dizanje kabine	188
6.4	Elementi za oslanjanje kabine	190
6.5	Uređaji za pranje vetrobranskog stakla	195
6.6	Mehanizam vrata	196

7.0 ELEKTRIČNE INSTALACIJE

7.1	Farovi	200
7.2	Pokazivači pravca	204
7.3	Stop i gabaritna svetla	206
7.4	Rotacione lampe	210
7.5	Sijalice, osigurači i tahograf listići	213
7.6	Kablovi električne instalacije	218
7.7	Kombinovani prekidači pod volanom	221
7.8	Akumulatori i pribor	222
7.9	Anlaseri i alternatori	226

8.0 PRIBORI

8.1	Obeležavajuće table i pribori A.D.R.	232
8.2	Oprema	247
8.3	Pribor za osiguravanje tereta	250
8.4	Lanci za sneg	252
8.5	Vučne kuke	254
8.6	Grejanje kabine	257

9.0 ULJA I MAZIVA

9.1	Ulja i maziva	263
-----	---------------------	-----

1.0 MOTOR



1.0 MOTOR

1.1	Delovi motora	14
1.2	Pumpe vode, ulja i upravljača	22
1.3	Termostati	26
1.4	Španeri motora i prenosni kaiševi	27
1.5	Turbo kompresori	30
1.6	Hlađenje motora (Visko ventilatori, hladnjaci, interkuleri, ekspanzione posude i hladnjaci ulja)	30
1.7	Hlađenje i grejanje kabine (Hladnjaci klime, kompresori klime i izmenjivači toplote)	33
1.8	Creva vode i interkulera	34
1.9	Filteri	37
1.10	Napajanje gorivom	40
1.11	Davači i senzori	44
1.12	Izduvni sistemi	50

DELOVI MOTORA

Poz.	Naziv	Federal Mogul broj	Mahle broj	KS broj	Dimenzije (mm)	Tip motora	OE broj	RAPIDEX broj
1.	Klip KPL	87-285900-00	227 37 00	94 487 600	Ø108 EU II	D0826 LF, LOH, LUH	51.02511.7291	MOTO0864
2.	Klip KPL	87-285900-10	227 33 00	93 137 600	Ø108 EU I	D0826 LF, LFL, LUH	51.02511.0069	MOTO0556
3.	Klip KPL	87-285900-40	-	-	Ø108 turbo	D0826 LF, OH, LOH	51.02511.7550	MOTO0358
4.	Klip KPL	87-136500-00	229 07 00	99 336 600	Ø108 EU III	D0834, 0836 LFL	51.02500.6035	MOTO0767
5.	Klip KPL	87-136500-10	229 07 00	99 336 600	Ø108 EU III	D0834, 0836 LFL	51.02501.6091	MOTO2142
6.	Klip KPL	87-136500-30	-	97 458 600	Ø108 EU III	D0834, 0836 LFL	51.02500.6062	MOTO2143
7.	Klip KPL	87-136500-65	-	40 217 600	Ø108 EU IV, V	D0834, 0836 LFL	51.02500.6213	MOTO2144
8.	Klip KPL	87-423000-00	229 37 00	40 595 600	Ø120 EU IV	D2066 EU IV	51.02500.6163	MOTO0129
9.	Klip KPL	87-428600-00	-	-	Ø120 EU V	D2066 EU V	51.02500.6126	MOTO2014
10.	Klip KPL	87-280200-10	228 22 00	92 824 600	Ø125 normal	D2566 (170-240 KS)	51.02501.0459	MOTO0638
11.	Klip KPL	87-280400-00	228 82 00	93 274 600	Ø125 turbo	D2566 (230-320KS)	51.02501.0436	MOTO0415
12.	Klip KPL	87-283100-00	228 98 00	90 583 600	Ø128 EU I turbo	D2866 (260-460KS)	51.02501.0886	MOTO0551
13.	Klip KPL	87-283100-30	228 90 00	90 334 600	Ø128 turbo	D2866 (260-420KS)	51.02501.0713	MOTO0865
14.	Klip KPL	87-283100-60	228 91 00	90 341 600	Ø128	D2866 (240-290KS)	51.02501.0787	MOTO0308

DELOVI MOTORA								
Poz.	Naziv	Federal Mogul broj	Mahle broj	KS broj	Dimenzije (mm)	Tip motora	OE broj	RAPIDEX broj
15.	Klip KPL	87-283100-80	228 31 00	90 578 600	Ø128 EU II turbo	D2866 LF16-37, LOH23-26, LUH20-26	51.02511.7271	MOTO0631
16.	Klip KPL	87-143800-00	229 05 00	94 846 600	Ø128 EU II, III	D2876 LF03, 4, 6	51.02511.0372	MOTO0293
17.	Klip KPL	87-143800-10	229 05 10	94 847 600	Ø128 EU II, III	D2876 LF03, 4, 14, 17	51.02511.0378	MOTO0294
18.	Klip KPL	87-143800-20	229 05 20	94 848 600	Ø128 EU II, III	D2876 LF03, 4, 14, 17	51.02511.0379	MOTO0866
19.	Klip KPL	87-143800-30	229 04 00	99 330 600	Ø128 EU III turbo	D2866 LF23 LOH27 LUH23	51.02500.6023	MOTO0307
20.	Klip KPL	87-143800-40	229 04 10	99 331 600	Ø128 EU III turbo	D2866 LF23 LOH27 LUH23	51.02511.0430	MOTO0867
21.	Klip KPL	87-124500-00	228 14 00	94 394 600	Ø128 EU II turbo	D2876 LF02	51.02511.0431	MOTO0292
22.	Klip KPL	87-143800-50	229 14 00	99 697 600	Ø128 EU III	D2876 LF EU III	51.02500.6041	MOTO1164
23.	Košuljica	14-027680-00	227 WT 39	89 470 110	Ø108	D0824, 0826	51.01201.0378	MOTO0403
24.	Košuljica	14-450370-00	227 WN 32	89 056 110	Ø125	D2565, 2566	51.01201.0296	MOTO0605
25.	Košuljica	14-452920-00	227 WN 37	89 186 110	Ø128 (10,07)	D2865, D2866, D2876	51.01201.0309	MOTO0616
26.	Košuljica	14-450030-00	227 WN 42	89 518 110	Ø128 (10,27)	D2865, D2866, D2876	51.01201.0344	MOTO0760
27.	Košuljica	14-452930-00	227 WN 43	89 324 110	Ø128 (10,57)	D2865, D2866, D2876	51.01201.0324	MOTO0688
28.	Košuljica	14-452910-00	227 WN 34	89 092 110	Ø128 (h = 253)	D2865, D2866	51.01201.0305	MOTO0760
29.	Košuljica	14-670050-00	227 WN 65	89 595 110	Ø128 EU III	D2876 LFL EU III	51.01201.0435	MOTO0129
30.	Košuljica	14-450630-00	227 WN 67	89 816 110	Ø120	D2066 LF01 EU IV	51.01201.0417	MOTO0777
31.	Karika	08-285900-00	227 33 N0	80 00146 10	Ø108 (3, 2,5, 4)	D0824, D0826	51.02503.7003	MOTO0224
32.	Karika	08-136500-10	229 07 N0	80 00524 10	Ø108 EU III	D0834, 0836	51.02503.0791	MOTO1222
33.	Karika	08-280200-00	228 05 N0	80 00151 10	Ø125 (3, 3, 5) turbo	D2565, D2566	51.02503.7006	MOTO0505
34.	Karika	08-280400-10	228 82 N0	80 00154 10	Ø125 (3,5, 3, 5)	D2565, D2566	51.02503.0530	MOTO0226

DELOVI MOTORA								
Poz.	Naziv	Federal Mogul broj	Mahle / Miba broj	KS broj	Dimenzije (mm)	Tip motora	OE broj	RAPIDEX broj
35.	Karike	08-283100-00	228 90 N0	80 00155 60	Ø128 (3,5, 3, 5)	D2865, D2866	51.02503.7007	MOTO0731
36.	Karike	08-104300-00 08-143800-00	227 01 N0	80 00300 10	Ø128 (4, 3, 4)	D2876, D2866 LF23	51.02503.0781	MOTO0291
37.	Karike	08-423000-00	209 22 N0	80 00716 10	Ø120 (3,5, 3, 4)	D2066 LF01 EU IV	51.02503.0787	MOTO0126
38.	Ležajevi radilice - leteći	71-3660/6	227PL20020	-	65 x 69 x 31	D0826	51.02410.0491	MOTO0427
39.	Ležajevi radilice - leteći	71-3938/6	227HL20871	77 807 600	70 x 74 x 27	D836LF, LOH, LUH EU III	51.02410.6638	MOTO0868
40.	Ležajevi radilice - leteći	71-3561/5	1304P50	87 506 600	90 x 95 x 36,20	D2565, 2865	51.02410.6402	MOTO0400
41.	Ležajevi radilice - leteći	71-3561/6	1304P60	87 406 600	90 x 95 x 36,20	D2566, 2866	51.02410.6466	MOTO0441
42.	Ležajevi radilice - leteći	71-3637/6	1795P60	78 901 600	90 x 95 x 36,20 -sputer	D2866 (340-480KS)	51.02410.6533	MOTO0757
43.	Ležajevi radilice - leteći	71-3812/6	1831P60	79 237 600	90 x 95 x 36,20 -sputer	D2876 LF	51.02410.6632	MOTO0526
44.	Ležajevi radilice - leteći	71-4529	227PS10790	79 298 600	90 x 95 x 36,20 -sputer	D2066 EU IV	51.02410.6672	MOTO1704
45.	Ležajevi radilice - leteći	71-4746	-	79 405 600	90 x 95 x 36,20 -sputer	D2066 EU V	51.02410.6698	MOTO1145
46.	Ležajevi radilice - ležeći	H049/7	227FL20018	77 587 600	77 x 82 x 26	D0826	51.01114.6072	MOTO0438
47.	Ležajevi radilice - ležeći	H082/7	227HL20871	77 744 600	77 x 82 x 26	D0836	51.01113.0062	MOTO0741
48.	Ležajevi radilice - ležeći	H992/7	1305H70	87 435 600	104 x 111 x 36	D2566, 2866, 2876	51.01110.6372	MOTO0662
49.	Ležajevi radilice - ležeći	H083/7	001HL10220	87 503 604	104 x 111 x 36	D2866, D2876	51.01113.6073	MOTO0398
50.	Ležajevi radilice - ležeći	H1239/7	001HL10220	87 503 604	104 x 111 x 36	D2066	51.01113.0113	MOTO0869
51.	Čaura klipnjače	55-3946	-	-	42 x 46 x 35,10	D0834, D0836 EU III	51.02405.1027	MOTO0870
52.	Čaura klipnjače	55-4532	-	-	52 x 56 x 45,50	D2066	51.02405.1046	MOTO0127
53.	Čaura klipnjače	55-2862	001BB10332	87 267 690	46 x 50,6 x 38,70	D2566, D2866	51.02405.0056	MOTO0245
54.	Čaura klipnjače	55-3328	001BS107191	87 346 690	48 x 50,6 x 38,70	D2566, D2866	51.02405.1003	MOTO0451
55.	Čaura klipnjače	55-3813	-	-	50 x 54 x 38,70	D2876	51.02405.1021	MOTO0402
56.	Čaura klipnjače	55-4563	-	-	-	D2066 LF01	51.02405.1057	MOTO0871

DELOVI MOTORA								
Poz.	Naziv	Federal Mogul broj	Reinz broj	Elring broj	Dimenzije (mm)	Tip motora	OE broj	RAPIDEX broj
57.	Garnitura zaptivača	20-26468-04/0	01-27660-03	921.760	Ø108	D0826 LF, LOH, LUH	51.00900.6532	MOTO0289
58.	Garnitura zaptivača	-	01-27660-07	804.422	Ø108	D0836 LF01-05, LOH01-04	51.00900.6627	MOTO0138
59.	Garnitura zaptivača	-	01-27660-11	742.770	Ø108	D0834 LOH01-03	51.00900.6720	MOTO2131
60.	Garnitura zaptivača	-	01-27660-06	273.070	Ø108	D0834 LOH01-03	51.00900.6645	MOTO2132
61.	Garnitura zaptivača	-	01-27660-10	542.130	Ø108	D0836 LFL40, 41	51.00900.6684	MOTO1862
62.	Garnitura zaptivača	-	01-37180-01	198.610	Ø120	D2066 LF	51.00900.6680	MOTO0622
63.	Garnitura zaptivača	20-26235-18/0	01-25275-11	518.346	Ø125, Ø128	D2866 LF	51.00900.6601	MOTO0321
64.	Garnitura zaptivača	-	01-25275-18	332.780	Ø128	D2866 LUH23, 24, 25, 27	51.00900.6648	MOTO0618
65.	Garnitura zaptivača	-	01-25275-17	061.690	Ø128	D2876 LF	51.00900.6635	MOTO0295
66.	Set zaptivača glave	21-26468-22/0	02-27660-02	835.641	Ø108	D0826 LF	51.00900.6550	MOTO0872
67.	Set zaptivača glave	-	02-37180-01	195.080	Ø120	D2066LF	51.00900.6681	MOTO0873
68.	Set zaptivača glave	21-26235-23/0	03-25275-03	834.330	Ø125, Ø128	D2866 LF	51.00900.6558	MOTO0296
69.	Set zaptivača glave	-	03-25275-06	298.770	Ø128	D2876	51.00900.6630	MOTO0663
70.	Zaptivač glave	30-026468-00	61-27660-30	845.710	Ø108	D0826, D0834	51.03901.0351	MOTO0578
71.	Zaptivač glave	-	61-37180-00	021.260	Ø120	D2066 LF	51.03901.0387	MOTO0613





DELOVI MOTORA								
Poz.	Naziv	Federal Mogul broj	Reinz broj	Elring broj	Dimenzije (mm)	Tip motora	OE broj	RAPIDEX broj
72.	Zaptivač glave	30-025059-20	61-25110-60	834.548	Ø125	D2566	51.03901.0342	MOTO0306
73.	Zaptivač glave	30-026235-30	61-25275-00	829.722	Ø125, Ø128	D2866, D2876	51.03901.0338	MOTO0383
74.	Zaptivač kartera	31-025060-10	71-25912-10	895.319	Ø108	D0826	51.05904.0139	MOTO0341
75.	Zaptivač kartera	-	71-38062-00	357.570	Ø120	D2066	51.05904.0212	MOTO0593
76.	Zaptivač kartera	31-023335-10	71-23603-10	775.330	Ø125, Ø128	D2565, D2865	51.05904.0131	MOTO0136
77.	Zaptivač kartera	31-023336-10	71-23601-10	921.084	Ø125, Ø128	D2566, D2866	51.05904.0132	MOTO0364
78.	Zaptivač kartera	-	71-33488-00	845.541	Ø128	D2866, D2876	51.05904.0189	MOTO0322
79.	Semering radilice	50-306595-70	81-27522-10	749.983	66 x 90 x 12	D0826	51.01510.0237	OSTA0277
80.	Semering radilice	50-305115-00	81-33801-00	323.772	110 x 130 x 13	D0826	51.01510.0151	MOTO0683
81.	Semering radilice	31-020252-10	-	-	85 x 104,3 x 10,8	D0836	51.01510.0005	OSTA0313
82.	Semering radilice	-	81-38069-00	158.510	100 x 130 x 12	D2066	51.01510.6008	MOTO0627
83.	Semering radilice	50-307027-70	-	-	105 x 130 x 12	D2566, D2866	51.01510.0145	MOTO0553
84.	Semering radilice	-	81-23112-30	766.852	105 x 130 x 12 PTFE	D2566, D2866, D2876	51.01510.0197	MOTO0305
85.	Semering radilice	50-305151-00	-	090.158	120 x 140 x 13	D2566, D2866, D2876	51.01510.0133	OSTA0234
86.	Semering radilice	-	81-23113-30	766.852	120 x 140 x 13 PTFE	D2566, D2866, D2876	51.01510.6004	MOTO0304







DELOVI MOTORA						
Poz.	Naziv	Tip motora	OE broj	Dimenzije (mm)	Ugao i kraj stabla	RAPIDEX broj
87.	Ventil usisni	D0824,0826	51.04101.0425	49 x 10 x 136,6	60° I zleb	MOTO1564
88.	Ventil izduvni	D0824,0826	51.04101.0410	42 x 10 x 136,3	45° I zleb	MOTO1565
89.	Ventil usisni	D0836,0834	51.04101.0537	38 x 7 x 141,5	60° III zleba	MOTO2226
90.	Ventil izduvni	D0836,0834	51.04101.0538	34 x 7 x 141,2	45° III zleba	MOTO2227
91.	Ventil usisni	D2066	51.04101.0574	40 x 9 x 160,4	60° III zleba	MOTO1417
92.	Ventil izduvni	D2066	51.04101.0546	38 x 9 x 160,4	45° III zleba	MOTO1418
93.	Ventil usisni	D2866	51.04101.0405	57 x 12 x 142,5	45° I zleb	MOTO2228
94.	Ventil usisni	D2866	51.04101.0375 51.04101.0348 51.04101.0478	58 x 12 x 142,6	60° I zleb	MOTO0214
95.	Ventil izduvni	D2866	51.04101.0367 51.04101.0447 51.04101.0479 51.04101.0487	51 x 12 x 142,5	45° I zleb	MOTO0600
96.	Ventil usisni	D2876	51.04101.0482 51.04101.0547	46 x 9 x 153,6	60° I zleb	MOTO1413
97.	Ventil izduvni	D2876	51.04101.0483 51.04101.0548	46 x 9 x 153,6	45° I zleb	MOTO1414
98.	Ventil usisni	D2876	51.04101.0523	44 x 9 x 153,6	60° III zleb	MOTO1415
99.	Ventil izduvni	D2876	51.04101.0524	45 x 9 x 153,6	45° III zleb	MOTO1416
100.	Vodica usisnog ventila	D0824, D0826	51.03201.1057 51.03201.0106	46 x 9 x 153,6	-	MOTO1562
101.	Vodica izduvnog ventila	D0824, D0826	51.03201.1053 51.03201.0098	10 x 16,03 x 55	-	MOTO1563



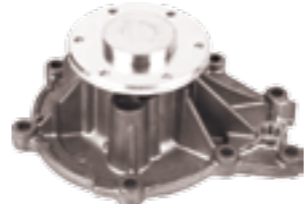

DELOVI MOTORA						
Poz.	Naziv	Tip motora	OE broj	Dimenzije (mm)	Ugao i kraj stabla	RAPIDEX broj
102.	Vodica usisnog/izduvnog ventila	D0836, D0834	51.03201.0122	7,02 x 13,03 x 60	-	MOTO2229
103.	Vodica usisnog/izduvnog ventila	D2866	51.03201.0088	12 x 18,04 x 64	-	MOTO0042
104.	Vodica usisnog ventila	D2866, D2876	51.03201.0108	12 x 18,04 x 59,50	-	MOTO0051
105.	Vodica izduvnog ventila	D2866, D2876	51.03201.0102	12 x 18,04 x 56	-	MOTO0236
106.	Vodica usisnog/izduvnog ventila	D2866, D2876	51.04101.0115 51.04101.0126	9 x 15,04 x 66,5.	-	MOTO1269



DELOVI MOTORA				
Poz.	Naziv	Tip motora / Dimenzije (mm)	OE broj	RAPIDEX broj
107.	Radilica	D2566, D2866	51.02100.6037 51.02100.7515 51.02100.7613 51.02100.7708 51.02100.7741	MOTO0884
108.	Radilica	D2876	51.02100.6018 51.02100.6038 51.02100.6044 51.02100.7706	MOTO0885
109.	Radilica	D2066	51.02101.0673	MOTO1756
110.	Klipnjača	D2566, D2866 d1=46, d2=95, L=251	51.02401.6141 51.02401.6214 51.02401.6244	MOTO0889
111.	Klipnjača	D2866, D2876	51.02400.6011 51.02400.6049 51.02401.6242 51.02401.6243 51.02401.6282	MOTO0131
112.	Klipnjača	D2066	51.02400.6066	MOTO1757
113.	Klipnjača	D2066	51.02400.6120	MOTO2372
114.	Glava motora	D2566, D2865, D2866	51.03101.6585	MOTO0891
115.	Glava motora	D2866LF23-28, D2876 LF03-11/14/17 LOH	51.03100.6053 51.03100.6802 51.03100.6807 51.03101.6824	MOTO0892
116.	Glava motora	D2876 LF12, 15, 25 EU III	51.03100.6181	MOTO1571

DELOVI MOTORA				
Poz.	Naziv	Tip motora / Dimenzije (mm)	OE broj	RAPIDEX broj
117.	Glava motora	D2066	51.03901.0403	MOTO2373
118.	Bregasta osovina	D2566, D2866	51.04401.6271 51.04401.6231 51.04401.6179	MOTO0895
119.	Bregasta osovina	D2866 LF, LOH, D2876 LF, LOH	51.04401.5053	MOTO0896
120.	Bregasta osovina	D2066	51.04400.6050	MOTO2377
121.	Bregasta osovina	D2066	51.04400.6398	MOTO1594
122.	Vijak klipnjače	D2066	51.90490.0079	MOTO2060
123.	Vijak klipnjače	D2566, D2866, D2876 M16 x 1,5	51.90020.0139	MOTO0049
124.	Vijak klipnjače	D2866, D2876 M14 x 1,5	51.90490.0021	MOTO0139
125.	Vijak klipnjače	D2866, D2876 M16 x 1,5	51.90021.0004	MOTO0200
126.	Podizač ventila	D0226, D0826, D0836	51.04301.0089	MOTO0899
127.	Podizač ventila	D2566, D2866, D2876	51.04301.0065	MOTO0056
128.	Podizač ventila	D2566, D2866, D2876 ojačan	51.04301.0109	MOTO0140
129.	Ventil pumpe ulja	D2566, D2866, D2876	51.05405.5013	MOTO0057
130.	Uljna dizna	D2566, D2866	51.01601.5066	MOTO0902
131.	Uljna dizna	D2566, D2866, D2876	51.01601.5083	MOTO0903
132.	Separator ulja - odušak	D2566, D2866, D2876	51.01804.7023	MOTO0046
133.	Separator ulja - odušak	D2566, D2866	51.01804.7026	MOTO0047
134.	Separator ulja - odušak	D2865, D2866, D2876	51.01804.7028	MOTO0048
135.	Separator ulja - odušak	D2866, D2876	51.01804.7037	MOTO0165
136.	Separator ulja - odušak	D2876	51.01804.7032	MOTO1438

PUMPE VODE						
Slika	Poz.	Model	Tip motora	Frimatec broj	OE broj	RAPIDEX broj
	1.	F90, BUS	D2566, D2866	220728	51.06500.6282	MOTO0287
	2.	BUS	D2566, D2840, D2865, D2866, D2876	220836	51.06500.6426	HLAĐ0613
	3.	F90, F2000, BUS Set za remont pumpe	D2865, D2866	220789 225775	51.06500.6408 51.06599.6012	MOTO0286 MOTO0273
	4.	F90, F2000	D2865, D2866, D2876, D2840	220876	51.06500.6492	MOTO0283
	5.	F90, F2000	D2865LF20, D2866LF/LF20	220999	51.06500.6547	MOTO0278
	6.	F2000	D2865LF21-24, D2866LF06/0920, D2876LF02, D2840	220816	51.06500.6479	MOTO0285

PUMPE VODE						
Slika	Poz.	Model	Tip motora	Frimatec broj	OE broj	RAPIDEX broj
	7.	F2000	D2865, D2840, D2866, D2876	220997	51.06500.6546	MOTO0279
	8.	L2000, M2000	D0826, D0834, D0836	2201066	51.06500.6606	MOTO0263
	9.	TGS	D0834, D0836	2201106	51.06500.7078	MOTO1701
	10.	TGA	D2876	2201065	51.06500.7066	MOTO0016
	11.	TGA	D2866, D2876	2201145	51.06500.7088	MOTO1543
	12.	TGS, TGX	D2066LUH01-48 D2876LF01	2201091	51.06500.6646	MOTO0011

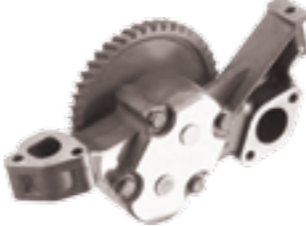
PUMPE VODE						
Slika	Poz.	Model	Tip motora	Frimatec broj	OE broj	RAPIDEX broj
	13.	TGS, TGX	D2066, D2676	2201098	51.06500.6642	MOTO1508
	14.	TGA, TGS TGX	D2066	2201081	51.06500.7049	HLAĐ0555
	15.	L2000	D0824, D0826	2201045	51.06500.6515	MOTO0776
	16.	F2000	D2865, D2866, D2876	2201108	51.06500.6457	MOTO0026

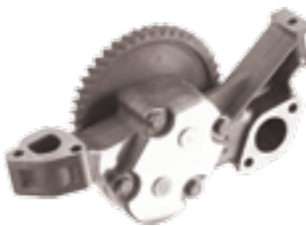
PUMPE ULJA					
Slika	Poz.	Model	Tip motora	OE broj	RAPIDEX broj
	1.	F90	D2565, D2566, D2865, D2866	51.05100.6133	MOTO1904
	2.	F90	D2566, D2865, D2866	51.05100.6150	MOTO0779
	3.	TGA, F2000	D2865, D2866, D2867	51.05100.6262	MOTO1905

PUMPE UPRAVLJAČA				
Slika	Poz.	Model	OE broj	RAPIDEX broj
	1.	F90, F2000, TGA 18/24/26/28/32/33/35/37/40/41	81.47101.6181	HIDR0013

TERMOSTATI						
Slika	Poz.	Model	T [°C]	KBP	OE broj	RAPIDEX broj
	1.	L2000, F2000, M2000 TGL, TGM, TGA, TGX, TGS	71°C	TH1513.71J	51.06402.0062	MOTO1679
	2.	L2000, F2000, M2000 TGL, TGM, TGA, TGX, TGS	79°C	TH1476.79J	51.06402.0044	MOTO1682
	3.	L2000, F2000, M2000 TGL, TGM, TGA, TGX, TGS	80°C	TH1513.80J	51.06402.0051	MOTO1683
	4.	L2000, F2000, M2000 TGL, TGM, TGA, TGX, TGS	83°C	TH1513.80J	51.06402.0060	MOTO1678



ŠPANERI					
Poz.	Slika	Model vozila	OE broj	KBP	RAPIDEX broj
1.		F2000, M2000	51.95800.7315	3.34077	MOTO2184
2.		E2000, F2000	51.95800.7396	VKMCV55001	MOTO0188
3.		F2000, TGA	51.95800.7397	VKMCV55002/ APV2461	MOTO0157/ MOTO1454
4.		TGA, TGS, TGX	51.95800.7459	APV1134/ VKMCV51004	MOTO1548/ MOTO0156

ROLERI				
Poz.	Model vozila	OE broj	KBP	RAPIDEX broj
1.	LION S COACH, LION S STAR	51.95800.6087	APV2339	MOTO1744
2.	F2000, TGA	51.95800.7431	VKMCV55003	MOTO0194
3.	TGA, TGL, TGX	51.95800.6092	APV2403	MOTO1610

KLINASTI I PK KAIŠEVI

Poz.	Dimenzija (mm)	Model vozila / Tip motora	RAPIDEX broj
1.	10 x 1250	D0824	REME0085
2.	10 x 1275	D0826	REME0086
3.	10 x 1300	M90 (D0826)	REME0087
4.	10 x 1325	M90 (D0826)	REME0088
5.	10 x 1375	M2000, L2000	REME0089
6.	10 x 1400	M2000, L2000	REME0090
7.	10 x 1500	F2000 (D2866)	REME0076
8.	10 x 1525	F2000 (D2866)	REME0215
9.	13 x 1225	L2000 (D2866)	REME0067
10.	13 x 1250	D2866	REME0229
11.	13 x 1275	F2000, TG	REME0219
12.	13 x 1300	F2000	VESA0541
13.	13 x 1325	F90, F2000	REME0220
14.	13 x 1350	F2000, TG	REME0091
15.	13 x 1400	M90, F90	REME0093
16.	13 x 1425	M90, F90	REME0221
17.	13 x 1450	M90, F90	VESA0538
18.	13 x 1525	F90, F2000	VESA0535
19.	13 x 1550	M90, F90	REME0095
20.	13 x 1575	M90, F90	REME0222
21.	13 x 1600	F90, F2000	REME0223
22.	4PK 1290	D2840	REME0097
23.	4PK 1390	D0834, D0836	REME0022

KLINASTI I PK KAIŠEVI

Poz.	Dimenzija (mm)	Model vozila / Tip motora	RAPIDEX broj
24.	5PK 1482	D2866, D2876	REME0101
25.	5PK 1525	TG, (D2066, D2876)	REME0102
26.	6PK 1515	D0826	REME0105
27.	6PK 1880	TG (D2066)	REME0107
28.	8PK 855	TGA	REME0109
29.	8PK 880	D2866, D2876	REME0110
30.	8PK 1158	TG (D2066)	REME0111
31.	8PK 1275	D0834, D0836	REME0120
32.	8PK 1375	D2866, D2876	REME0341
33.	8PK 1495	D0836, D2866	REME0126
34.	8PK 1548	D0836	REME0130
35.	8PK 1580	D0836	REME0131
36.	8PK 1635	TG (D2066)	REME0135
37.	8PK 1655	D2066, D2676	REME0136
38.	8PK 1920	D2066, D2676	REME0004
39.	9PK 1200	D0834, D0836	REME0168
40.	9PK 1330	D0824, D0826	REME0169
41.	10PK 1300	D0836	REME0181
42.	10PK 1580	D0836	REME0186
43.	10PK 1695	TG (D2066)	REME0190
44.	10PK 1745	D0836	REME0191
45.	10PK 1863	D0826	REME0195
46.	10PK 1980	D0836, D2866	REME0198
47.	10PK 2108	TGA (D2866, D2876)	REME0199
48.	10PK 2340	TGA (D2066, D2676)	REME0201
49.	12PK 1300	D0826, D0834, D0836	REME0208
50.	14PK 1306	D2866, TGA (D2876)	REME0212
51.	14PK 1590	D2866, TGA (D2876)	REME0213
52.	14PK 1708	D2866, TGA (D2876)	REME0214

1

TURBO KOMPRESORI

Poz.	Model	OE broj	RAPIDEX broj
1.	D0826, D0836	51.09100.7439	MOTO0953
2.	D2566, D2866	51.09100.7086	MOTO0954
3.	D2866, D2066	51.09100.7629	MOTO1794
4.	D2866, D2876	51.09100.7429	MOTO0955
5.	D2866	51.09100.7766	MOTO1940
6.	D2876	51.09100.7495	MOTO0956
7.	D2876	51.09100.7785	MOTO0957
8.	D2876	51.09100.7368	MOTO1971



VISKO VENTILATORI

Poz.	Model	Dimenzija (mm)	OE broj	RAPIDEX broj
1.	M2000L	Ø290	51.06630.0068	MOTO1233
2.	F90, F2000	Ø203	51.06630.0066	MOTO0930
3.	M90, TGL	Ø186	51.06630.0067	MOTO0027
4.	F2000, TGA	Ø190	51.06630.0115	MOTO1175

1

VISKO VENTILATORI

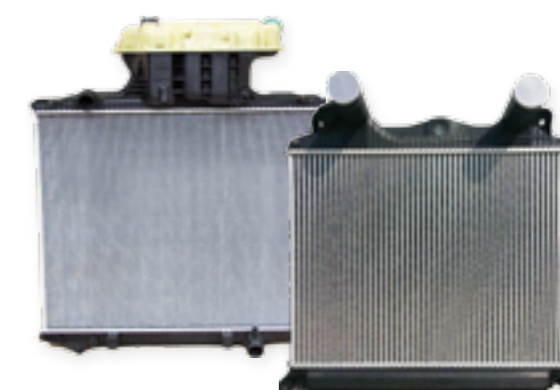
Poz.	Model	Dimenzija (mm)	OE broj	RAPIDEX broj
5.	F2000, TGA	Ø236	51.06630.0077	MOTO1604
6.	TGA	Ø245	51.06630.0130	MOTO1249
7.	TGA	Ø270	51.06630.0119	MOTO1253
8.	TGA	Ø245	51.06630.0129	MOTO1708
9.	TGA, TGS, TGX	Ø205	51.06630.0131	MOTO1250

HLADNJACI

Poz.	Model	Dimenzija (mm)	OE broj	RAPIDEX broj
1.	TGS, TGX	765 x 983 x 42	81.06101.6458	HLAĐ0052
2.	TGA, TGS, TGX	920 x 938 x 42	81.06101.6512	HLAĐ0151
3.	TGA, TGS, TGX	845 x 938 x 42	81.06101.6482	HLAĐ0824

INTERKULERI

Poz.	Model	Dimenzija (mm)	OE broj	RAPIDEX broj
1.	TGA	665 x 892 x 66	81.06130.0176	HLAĐ0049
2.	TGA	665 x 892 x 66	81.06130.0175	HLAĐ0599
3.	TGA, TGS, TGX	665 x 892 x 64	81.06130.0199	HLAĐ0297
4.	TGA, TGS, TGX	665 x 892 x 64	81.06130.0180	HLAĐ0296
5.	TGA, TGS, TGX	665 x 892 x 64	81.06130.0179	HLAĐ0298

EKSPANZIONE POSUDE

Poz.	Model	Dimenzija (mm)	OE broj	RAPIDEX broj
1.	F90	743 x 321 x 124	81.06102.6201	HLAĐ0042
2.	F2000	743 x 321 x 108	81.06102.6110	HLAĐ0150
3.	F2000	743 x 321 x 108	81.06102.6209	HLAĐ0139

HLADNJACI ULJA

Poz.	Model	OE broj	RAPIDEX broj
1.	D2066	51.05601.0161	MOTO1899
2.	F2000, TGA	51.05601.0148	MOTO0168
3.	F2000, TGA	51.05601.0121	MOTO0163

HLADNJACI KLIME









Poz.	Model	Dimenzija (mm)	OE broj	RAPIDEX broj
1.	TGA, TGL, TGS, TGX	750 x 351 x 16	81.61920.0018	HLAĐ0531











KOMPRESORI KLIME

Poz.	Model	Opis	OE broj	RAPIDEX broj
1.	F2000, TGA, TGL, TGM, TGS, TGX	Remenica Ø119 mm, 8 kanala	51.77970.7028	MOTO2578
2.	TGA, TGM, TGL	Remenica Ø119 mm, 8 kanala	51.77970.7015	HLADJ0821

IZMENJIVAČI TOPLOTE

Poz.	Model	Dimenzija (mm)	OE broj	RAPIDEX broj
1.	TGA 2000→	370 x 189 x 42	81.61901.6166	HLAĐA0130

CREVA VODE					
Slika	Poz.	Model vozila	Dimenzije (mm)	OE broj	RAPIDEX broj
	1.	M2000 , F2000	60 x 60 x 460	81.96301.0659	HLAĐ0114
	2.	M2000 , F2000	60 x 60 x 615	81.96305.0088	HLAĐ0201
	3.	M2000 , F20000	60 x 60 x 630	81.96305.0129	HLAĐ0115
	4.	M2000, F2000, TGA	18 x 18 x 330	81.96305.0192	HLAĐ0116
	5.	F2000, TGA	18 x 18 x 380	81.96305.0300	HLAĐ0094
	6.	F2000, TGA	18 x 18 x 630	81.96305.0217	HLAĐ0102
	7.	M2000, TGL	50 x 50 x 485	81.96301.0906	HLAĐ0111
	8.	TGA, TGL, TGM, TGX	18 x 18 x 460	81.96301.0895	HLAĐ0112
	9.	TGA, TGL, TGM, TGS, TGX	18 x 18 x 18	81.96301.0896	HLAĐ0046

CREVA VODE					
Slika	Poz.	Model vozila	Dimenzije (mm)	OE broj	RAPIDEX broj
	10.	TGA, TGL, TGM	18 x 18 x 280	81.96301.0894	HLAĐ0113
	11.	M2000, TGL	18 x 18 x 960	81.96305.0304	HLAĐ0109
	12.	M2000, TGL	50 x 50 x 565	81.96301.0904	HLAĐ0110
	13.	TGA, TGL	60 x 60 x 430	81.96301.0677	HLAĐ0082
	14.	TGA, TGL	60 x 60 x 620	81.96301.0898	HLAĐ0083
	15.	TGA, TGS, TGX	18 x 18 x 520	81.96305.0262	HLAĐ0103
	16.	TGA, TGS, TGX	18 x 18 x 510	81.96305.0272	HLAĐ0104
	17.	TGA, TGS, TGX	60 x 60 x 710	81.96301.0889	HLAĐ0604
	18.	TGA, TGS, TGX	18 x 18 x 170	81.96305.0194	HLAĐ0118

CREVA VODE					
Slika	Poz.	Model vozila	Dimenzije (mm)	OE broj	RAPIDEX broj
	19.	TGA, TGS, TGX	18 x 18 x 200	81.96305.0193	HLAD0119
	20.	TGA, TGS, TGX	18 x 18 x 550	81.96305.0197	HLAD0120
	21.	TGA, TGS, TGX	60 x 60 x 600	81.96301.0678	HLAD0603
	22.	TGA, TGS, TGX	22 x 22 x 120	81.96305.0167	HLAD0697

CREVA INTERKULERA					
Slika	Poz.	Model vozila	Dimenzije (mm)	OE broj	RAPIDEX broj
	1.	F90, NG	100 x 230	81.96301.0587	MOTO1144
	2.	F90, F2000, TGA	90 x 290	81.96301.0668	MOTO0145
	3.	TGA, TGX, TGS	90 x 285	81.96301.0900	MOTO1146



FILTERI ULJA									
Poz.	Hengst broj	A (mm)	B (mm)	C (mm)	G (mm)	H (mm)	Model	OE broj	RAPIDEX broj
1.	H210W01	109,00	92,00		M30 x 2	180,50	L2000, M2000, M90, LE, ME	51.05501.7180	FILT0225
2.	E172HD35	83,00	37,00	37,00	-	174,00	TGL, TGM 2005-	51.05500.6073	FILT0320
3.	E251HD11	120,00	56,00	13,00	-	270,00	F90	81.05504.0041	FILT0227
4.	E161HD28	83,00	37,00	28,00	-	212,50	F90, F2000	51.05504.0096	FILT0003
5.	E197HD31	83,00	21,00	21,00	-	193,00	F90, F2000	51.05504.0094	FILT0246
6.	E13HD47	121,00	56,00	56,00	-	148,00	F2000, TGA D2866, D2876	51.05504.0098	FILT0322
7.	E422HD86	121,00	57,00	44,50	-	203,50	TGS, TGA, TGX D2066, D2676	51.05504.0108	FILT0325

FILTERI GORIVA									
Poz.	Hengst broj	A (mm)	B (mm)	C (mm)	G (mm)	H (mm)	Model	OE broj	RAPIDEX broj
1.	E10KPD10	83,00	13,80	-	-	145,00	M90, F90	81.12503.0063	FILT0245
2.	H70WDK14	76,00	62,50	71,00	M16 x 1,5	155,00	L2000, M90, M2000, LE, ME, F90, F2000	51.12503.0072	FILT0204
3.	E56KPD27	76,00	27,50	12,00	-	229,00	TGA 2000-D2866, D2876	51.12503.0048	FILT0314
4.	E422KPD98	95,00	46,00	14,00	-	172,50	TGL, TGM, TGS TGA 2005-TGX	51.12503.0063	FILT0284

SEPARATOR GORIVA									
Poz.	Hengst broj	A (mm)	B (mm)	C (mm)	G (mm)	H (mm)	Model	OE broj	RAPIDEX broj
1.	E0530K02	76,00	76,00	-	-	54,00	M2000, TGL	85.12501.0005	FILT0115
2.	E1030K	89,00	89,00	-	-	55,00	TGA, TGS, TGX	81.12503.0086	FILT0334

FILTERI VAZDUHA									
Poz.	Hengst broj	A (mm)	B (mm)	C (mm)	G (mm)	H (mm)	Model	OE broj	RAPIDEX broj
1.	E115L	198,00	103,00	-	-	376,00	L2000, M2000, G/M90	81.08304.0056	FILT0075
2.	E116L	228,00	116,00	10,50	-	381,00	L2000, G90	81.08304.0064	FILT0224
3.	E307L	248,50	119,00	-	-	382,00	L2000, LE, M2000, ME	81.08304.0087	FILT0295
4.	E214L	243,00	132,00	-	-	376,00	L2000, M2000	81.08304.0074	FILT0300
5.	E218L	302,00	191,00	-	-	381,00	NL, NG, SG	81.08304.0086	FILT0058
6.	E661L	227,00	130,00	-	-	305,00	TGL, TGM	81.08405.0023	FILT0278
7.	E811L	250,00	125,00	-	-	460,00	TGL, TGM	81.08405.0018	FILT0117
8.	E118L	302,00	191,00	-	-	473,00	M90, G90, M2000, F90	81.08304.0044	FILT0323
9.	E237L	303,00	167,00	-	-	477,50	F90, F2000	81.08304.0097	FILT0275
10.	E428LO1	265,00	170,00	-	-	511,00	TGS, TGA, TGX	81.08405.0021	FILT0277
11.	E428LS Dopunski	155,50	137,00	-	-	456,50	TGS, TGA, TGX	81.08405.0017	FILT0381

FILTERI KABINE									
Poz.	Hengst broj	A (mm)	B (mm)	C (mm)	G (mm)	H (mm)	Model	OE broj	RAPIDEX broj
1.	E949LI	362,00	158,00	-	-	40,00	L2000, LE	85.61950.0025	FILT0266
2.	E906LI	401,80	187,00	-	-	31,00	M2000, ME, F2000	81.61910.0011	FILT0199
3.	E954LI	472,00	189,00	-	-	70,00	TGL, TGM, TGS, TGA, TGX	81.61910.0018	FILT0236
4.	E954LC	470,00	184,00	-	-	70,00	TGL, TGM, TGS, TGA, TGX	81.61910.0019	FILT0276

OSTALI FILTERI									
Poz.	Hengst broj	A (mm)	B (mm)	C (mm)	G (mm)	H (mm)	Model	OE broj	RAPIDEX broj
1.	E10H02	58,00	18,50	18,50	-	100,00	SVI MODELI Filter hidrauličke volana	81.47301.6005	FILT0214
2.	E6KS	45,00	7,80	-	-	84,00	L2000, M2000	81.11101.6151	FILT0216
3.	E39HD120	70,00	34,00	35,00	-	105,00	Zf menjač	81.33001.6442	FILT0697
4.	E39HD131	70,00	34,00	35,00	-	105,00	Zf menjač	81.33215.0002	FILT1000
5.	E101UD178 Ad blue	69,00	25,00	-	-	75,00	TGS, TGA, TGX	81.15403.6015	FILT0015

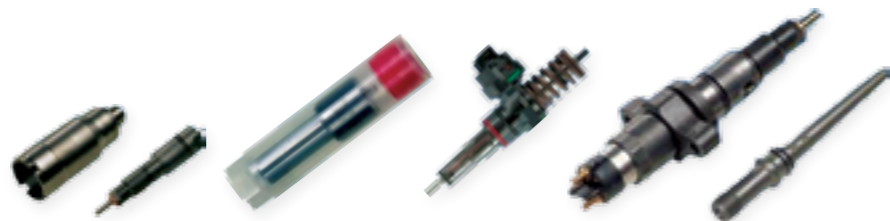

BRIZGALJKE I ULOŠCI BRIZGALJKI

Poz.	Model vozila / Tip motora	KBP	OE broj	RAPIDEX broj
1.	D0826, D0824	DLLA134P180	51.10102.0202	NAP.0101
2.	D0826, D0824	DSLA154P492	51.10102.0234	NAP.0102
3.	D0826	DSLA78P322	51.10102.0216	NAP.0103
4.	D0826	DLLA140P175	51.10102.0199	NAP.0104
5.	D2566	DSLA154P625	51.10102.0237	NAP.0105
6.	D2566	DLLA30S678	51.10102.0146	NAP.0106
7.	D2566	DLLA25S722	51.10102.0150	NAP.0107
8.	D2566	DLLA30S931	51.10102.0188	NAP.0108
9.	D2866, D2840	DLLA136S943	51.10102.0189	NAP.0109
10.	D2866, D2865	DLLA144P184	51.10102.0205	NAP.0110
11.	D2865	DLLA146P166	51.10102.0206	NAP.0111
12.	D2865 LUH	DLLA152P531	51.10102.0231	NAP.0112
13.	D2866, D2876	DLLA152P452	51.10102.0221	NAP.0064
14.	D2876, TGA	DLLA154P866	51.10102.0252	NAP.0063
15.	TGA COMMON RAIL	DLLA144P1417	51.10102.0304	NAP.0113
16.	D2866EU III, LF, LUH, LOH	DLLA152P967	51.10102.0259	NAP.0148
17.	D2866, D2876	DLLA154P866	51.10102.0252	NAP.0063
18.	D0834, D0836	DSLA157P955	51.10102.0260	NAP.0149
19.	D0836	DSLA154P960	51.10102.0258	NAP.0007
20.	D2866 LF, LUH, LOH	DLLA152P1231	51.10102.0277	NAP.0150
21.	D2866 LUH	DLLA152P1466	51.10102.0305	NAP.0151
22.	D2866, 2876	DLLA152P452	51.10102.0221	NAP.0064
23.	D2866	0 432 191 417	51.10100.6037	NAP.0220

BRIZGALJKE I ULOŠCI BRIZGALJKI

Poz.	Model vozila / Tip motora	KBP	OE broj	RAPIDEX broj
24.	D2866, D2876	0 432 191 416	51.10100.7450	NAP.0242
25.	TGL, TGM, D0834, D0836	0 445 120 045	51.10100.6050	NAP.0152
26.	TGL, TGM, D0834, D0836	0 445 120 098	51.10100.6065	NAP.0153
27.	TGA D2066, D2876	0 445 120 030	51.10100.6032	NAP.0154
28.	TGA D2066	0 445 120 061	51.10100.6064	NAP.0155
29.	TGA 26.280, 330	0 445 020 014	51.11103.7655	NAP.0156
30.	TGA 18, 24, 26, 28, 32, 33, 35, 41	0 445 020 018	51.11103.7740	NAP.0157
31.	TGA 8, 24, 26, 28, 32, 33, 35, 41	0 445 020 023	51.11103.7738	NAP.0158

AC PUMPE

Poz.	Model vozila	OE broj	RAPIDEX broj
1.	D0824, D0826	51.12101.7136	NAP.0171
2.	D0826, D0836, D2866, D2876	51.12150.7022	NAP.0172
3.	D0826, D0836, D2866, D2876	51.12101.7101	NAP.0049
4.	D2566, D2866	51.12101.7038	NAP.0174
5.	D0826, D0836, D2866, D2876	51.12501.7228	NAP.0175
6.	TG D2866, D2876	51.12501.7193	NAP.0051
7.	TG	51.12150.0001	NAP.0392
8.	UNIVERZALNA NA ŠASIJI	-	NAP.0085
9.	RUCNA PUMPA (DRUKALICA)	-	NAP.0214

REZERVOARI GORIVA

Poz.	Model vozila	Dimenzija (mm)	Zapremina (l)	RAPIDEX broj
1.	F90, F2000	1050 x 675 x 620	400	NAP.0188
2.	F90, F2000	1600 x 675 x 620	600	NAP.0189
3.	F2000	1460 x 720 x 720	700	NAP.0190
4.	TGA	1960 x 720 x 720	930	NAP.0191

POKLOPCI

Poz.	Naziv	Model vozila	OE broj	RAPIDEX broj
1.	POKLOPAC REZERVOARA Ø80 mm	M/F90, M/L2000, TGL, TGM, TGA	81.12210.6027	OPRE0074
2.	POKLOPAC ULJA	D0826, 0836, 2066, 2866, 2876	81.12210.0007	OPRE0459
3.	POKLOPAC EKSPANZIONE POSUDE	M/F90, M/L2000, TGL, TGM, TGA	81.06111.0018	OPRE0460
4.	POKLOPAC EKSPANZIONE POSUDE	M/F90, M/L2000, TGL, TGM, TGA	81.06111.0020	OPRE0461
5.	POKLOPAC EKSPANZIONE POSUDE	TGA, TGX	81.06110.0007	OPRE0462

PLOVCI







Poz.	Model vozila	OE broj	RAPIDEX broj
1.	M/F90, M2000, F2000, TGA	81.27201.6094	NAP.0020
2.	M/F90, M2000, F2000, TGA	81.27203.6033	NAP.0205
3.	L2000, F2000	81.27203.6030	NAP.0248



DELOVI SISTEMA UBRIZGAVANJA

Poz.	Naziv	Model vozila	OE broj	RAPIDEX broj
1.	SET ZA REPARACIJU RUČNE PUMPE GORIVA	TGA 2866, 2876	51.12150.7027	NAP.0246
2.	VENTIL FILTERA GORIVA	TGA 2866, 2876	51.12505.0021	NAP.0247
3.	ČAŠICA KOMPLET STAKLENA SA NOSAČEM	F2000 2866	51.12501.7019	NAP.0287
4.	SET VENTILA ŠASIJSKE PUMPE	F90, F2000, TGA	81.12108.0010	NAP.0347
5.	SET VENTILA AC PUMPE NA BOSCH PUMPI	F90, F2000, TGA	-	NAP.0349
6.	PRELIVNI VENTIL HP PUMPE	TG 2066	51.11107.0029	NAP.0362
7.	ČAŠICA SEPARATORA	TGA	81.12512.0004	NAP.0004
8.	PRELIVNI VENTIL M14	F90, F2000, TGA	51.12505.0004	NAP.0037
9.	PRELIVNI VENTIL M14	F90, F2000, TGA	81.12505.0012	NAP.0041
10.	PRELIVNI VENTIL	F90, F2000, TGA	90.81692.9667	NAP.0042





DAVAČI I SENZORI						
Slika	Poz.	Model vozila	Tip motora	Dimenzije (mm)	OE broj	RAPIDEX broj
	1.	F90, BUS	D2566, D2866	M14x1,5 95°C	51.27420.7005	ELEK0483
	2.	TGA, TGL, F2000, L2000	D0836, D2066, D2866, D2876	-	51.27421.0165	MOTO0807
	3.	TGA, TGL, F2000, L2000	D0826, D2066 D2866, D2876	-	51.27421.0077	MOTO0811
	4.	TGA, TGL, TGM, TGX, F2000, L2000	D0834, D0836, D2066, D2866, D2876	-	51.27421.0262	ELEK1237
	5.	TGA, F2000, L2000	D0834, D0836, D2866, D2876	-	51.27120.0014	ELEK0696
	6.	TGA, F2000	D2866, D2876	-	51.27120.0015	ELEK0697
	7.	TGA, TGL, TGM, TGX, F2000, L2000	D0834, D0836, D2066, D2866, D2876	-	51.27421.0229	ELEK1309

DAVAČI I SENZORI						
Slika	Poz.	Model vozila	Tip motora	Dimenzije (mm)	OE broj	RAPIDEX broj
	8.	TGA, TGL, TGM, TGX, F2000, L2000	D0834, D0836, D2066, D2866, D2876	-	51.27421.0263	NAP.0307
	9.	TGA, TGL, TGX, L2000	D0836, D2066, D2876	-	51.27421.0178	ELEK1018
	10.	TGA, TGS, TGX, TGL, TGM L2000	D0834, D0836, D2066, D2876	-	51.27421.0169	ELEK1231
	11.	TGA, TGS	D2066	-	51.12505.0027	NAP.0301
	12.	TGA, F2000	D2866, D2876	-	51.12505.0024	NAP.0315
	13.	TGA, TGS, TGX	D2066, D2676	-	51.12505.0033	NAP.0360
	14.	TGA, F2000, L2000	D0826, D0834, D0836, D2866, D2876	-	51.27120.0008	ELEK0936

DAVAČI I SENZORI						
Slika	Poz.	Model vozila	Tip motora	Dimenzije (mm)	OE broj	RAPIDEX broj
	15.	TGA, F2000, L2000	D0826, D0834, D2866, D2876	-	51.27120.0009	ELEK1501
	16.	TGA, F2000, L2000	D0826, D0834, D0836, D2866, D2876	-	51.27421.0113	HLAĐ0661
	17.	TGA, F2000, L2000	D0826, D0834, D0836, D2866, D2876	-	51.27421.0128	MOTO0022
	18.	M90, F90, F2000	D0824, D0836, D2866	4,8 - 5,2 bar, M12 x 1,5	81.25520.0117	ELEK0746
	19.	M90, F90, F2000	D0824, D0836, D2866	0,3 - 0,8 bar, M12 x 1,5	81.25520.0152	HLAĐ0124
	20.	L2000, M2000, F2000	D0824, D0836, D2866	M22 x 1	81.25520.0171	ELEK0747
	21.	L2000, M2000, F2000, Lions, Neoplan	D0824, D0836, D2866	0-16 bar, 5,3 ± 0,4 bar, M12 x 1,5	81.27421.0151	MOTO0804

DAVAČI I SENZORI						
Slika	Poz.	Model vozila	Tip motora	Dimenzije (mm)	OE broj	RAPIDEX broj
	22.	TGA, TGL, F2000	D0826, D2066, D2866, D2876	-	81.27421.0077	MOTO0060
	23.	TGA, TGS, TGM	D2066, D2876	-	81.27421.0204	MOTO2101
	24.	TGA, TGS, TGX, TGL, TGM	D2066, D2876	-	81.27421.0264	MOTO1798
	25.	Lions, Neoplan	-	-	81.27421.0181	HLAĐ0128
	26.	TGA, F2000, L2000	D0826, D0834, D0836, D2866, D2876	-	81.27421.0125	HLAĐ0783
	27.	TGA, TGS, TGX, F2000	D2066, D2876 D2866	-	81.27421.0232	HLAĐ0125
	28.	TGA, TGS, TGX, TGL, TGM, F2000	D2066, D2876 D2866	-	81.61980.6031	HLAĐ0127

DAVAČI I SENZORI						
Slika	Poz.	Model vozila	Tip motora	Dimenzije (mm)	OE broj	RAPIDEX broj
	29.	TGA, TGS, TGX, F2000	D2066, D2876 D2866	-	81.27421.0246	KOCN1917
	30.	F2000	D2866	-	81.25503.0244	KOCN2216
	31.	M2000, L2000, F2000	D0824, D0826, D2866	-	81.27121.0040	ELEK0164
	32.	TGA, F2000, L2000	D0824, D0826, D2866, D2876	0-5 bar, 0,25±0,15, M18 x 1,5	81.27421.0109	ELEK0052
	33.	TGA, TGS, TGX	D2066, D2876	-	81.25503.6136	ELEK1686
	34.	L2000, M2000, F2000	D0824, D0826, D2866	-	81.27421.0137	ELEK1530
	35.	TGA, TGM, TGL	D2066, D2876	-	81.27121.0041	ELEK0165

DAVAČI I SENZORI						
Slika	Poz.	Model vozila	Tip motora	Dimenzije (mm)	OE broj	RAPIDEX broj
	36.	TGA, TGS, TGX, TGL, TGM	D2066, D2876	-	82.27421.0032	ELEK0166
	37.	F2000	D2866	-	81.27420.0103	ELEK1615
	38.	TGA, TGS, TGX, F2000	D2066, D2876 D2866	-	81.25909.0043	ELEK1357
	39.	TGA, F2000	D2866, D2876	-	81.27420.0085	ELEK1425
	40.	TGA, TGS, TGX, TGL, TGM	D2066, D2876	-	81.25970.6094	ELEK0246

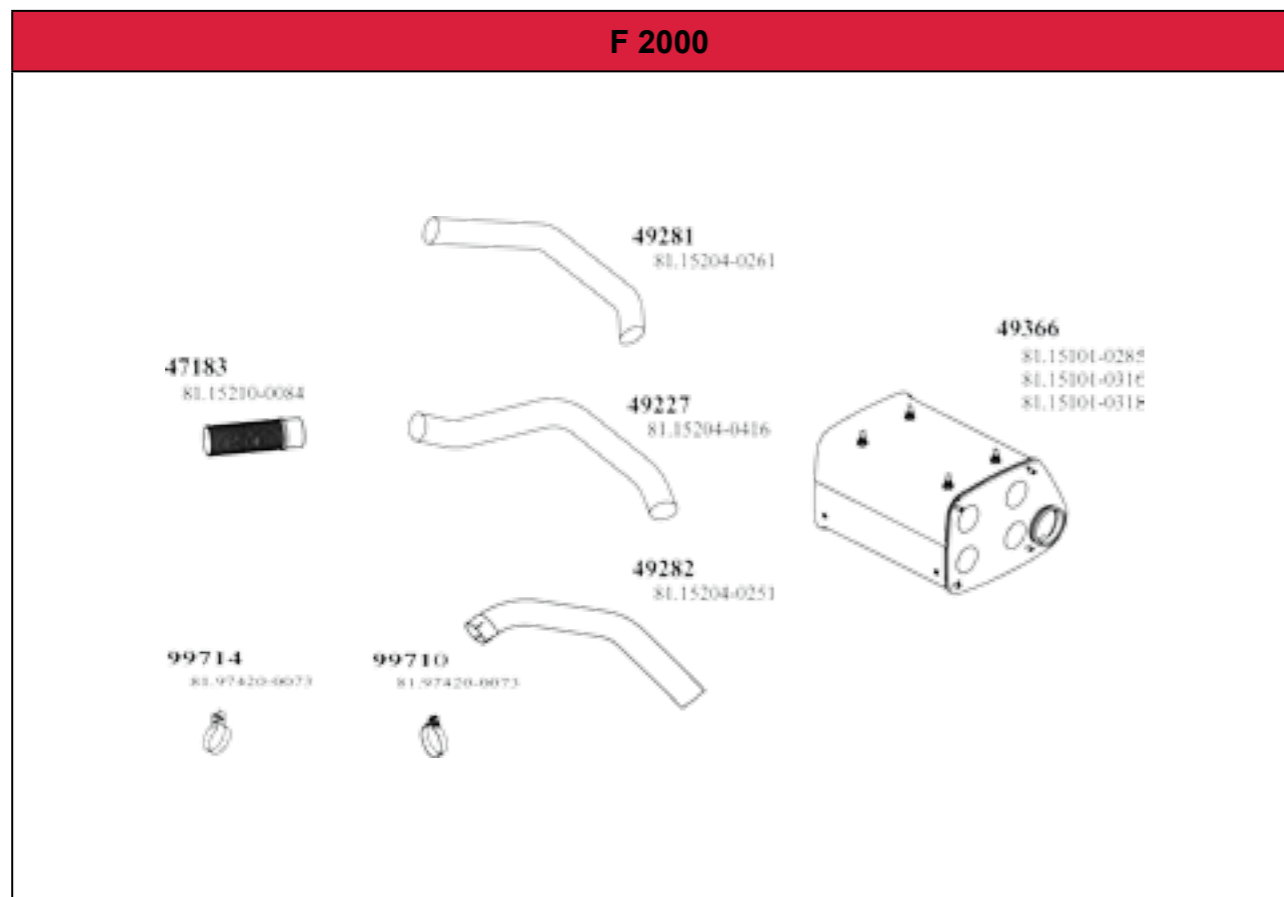
1

ELEMENTI IZDUVNOG SISTEMA - F 2000				
Poz.	Naziv	Dinex broj	OE broj	RAPIDEX broj
1.	LONAC	49366	81.15101.0285	IZDU0088
2.	CEV	49281	81.15204.0261	IZDU0243
3.	CEV	49227	81.15204.0416	IZDU0311
4.	CEV	49282	81.15204.0251	IZDU0116
5.	CEV GIBLJIVA	47183	81.15210.0084	IZDU0292
6.	ŠELNA	99714	81.97420.0073	IZDU0320
7.	ŠELNA	99710	81.97420.0073	IZDU2655

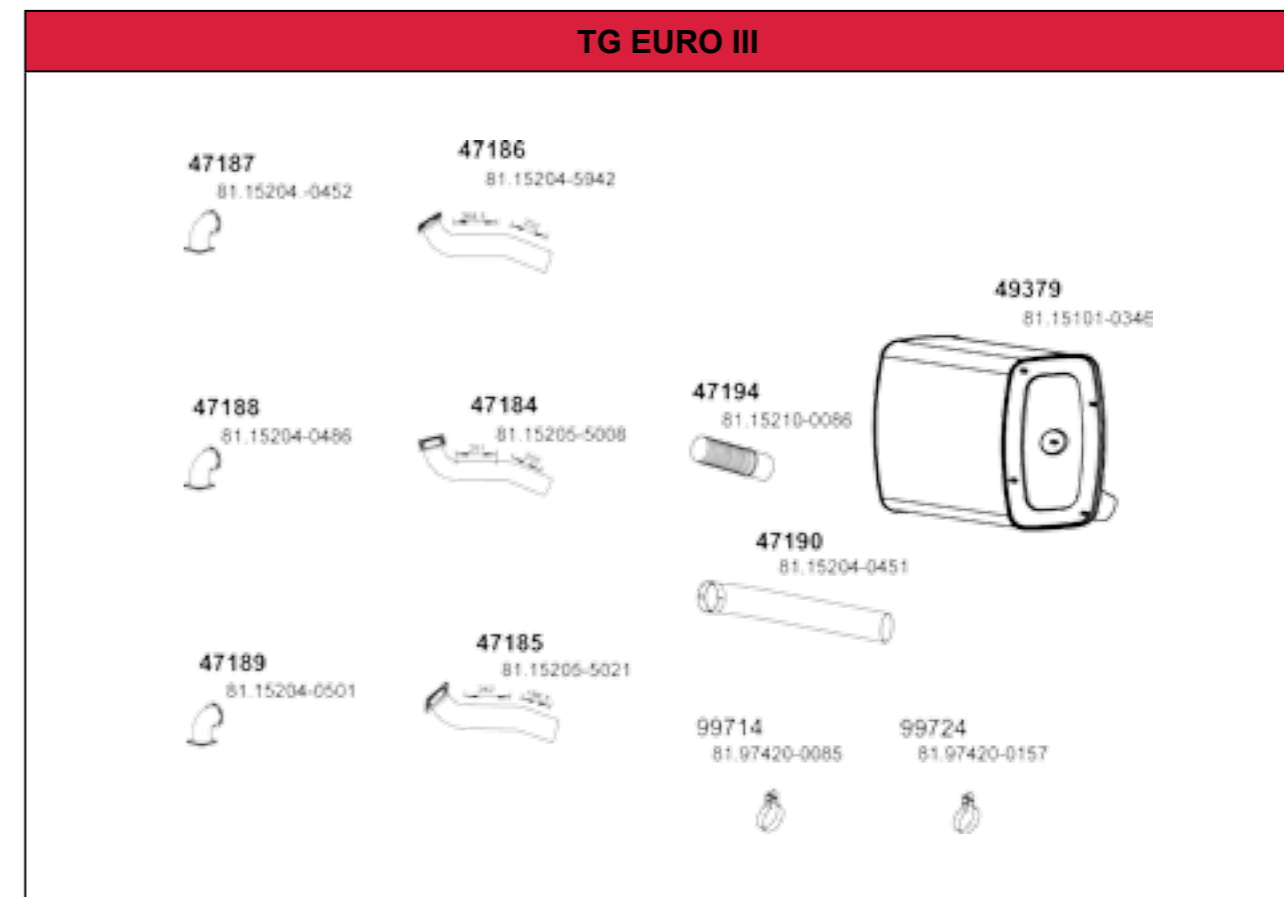
1

ELEMENTI IZDUVNOG SISTEMA - TG EURO III				
Poz.	Naziv	Dinex broj	OE broj	RAPIDEX broj
1.	LONAC	49379	81.15101.0346	IZDU0051
2.	CEV	47270(47190)	81.15204.0451	IZDU0017
3.	CEV GIBLJIVA	47271(47194)	81.15210.0086	IZDU0206
4.	CEV	47269(47186)	81.15204.5942	IZDU0118
5.	CEV	47184	81.15205.5008	IZDU0119
6.	CEV	47185	81.15205.5021	IZDU0120
7.	CEV	47187	81.15204.0452	IZDU0123
8.	CEV	47188	81.15204.0486	IZDU0122
9.	CEV	47189	81.15204.0501	IZDU0121
10.	ŠELNA	99714	81.97420.0085	IZDU0386
11.	ŠELNA	99724	81.97420.0157	IZDU0320

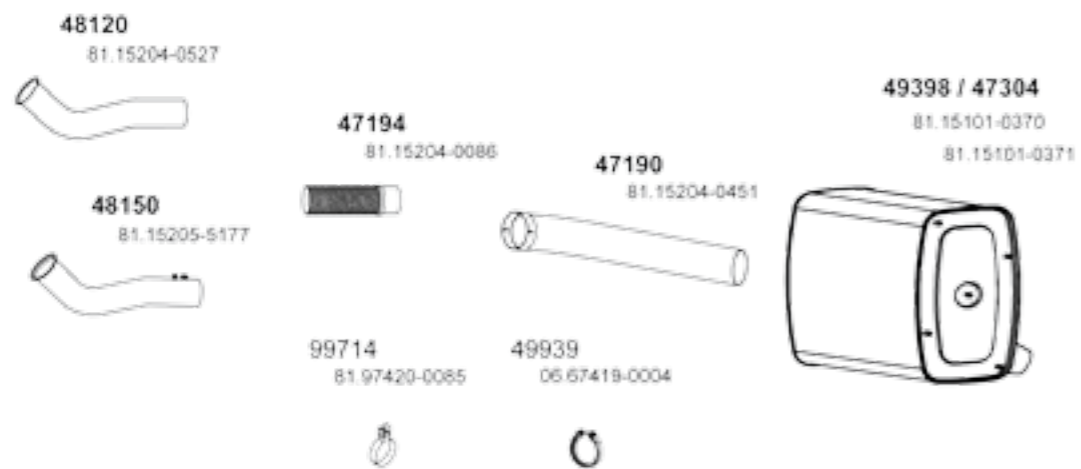
TG EURO IV

ELEMENTI IZDUVNOG SISTEMA - TG EURO IV

Poz.	Naziv	Dinex broj	OE broj	RAPIDEX broj
1.	LONAC	49398	81.15101.0370	IZDU0498
2.	LONAC	47304	81.15101.0371	IZDU0234
3.	CEV	47190	81.15204.0451	IZDU0047
4.	CEV GIBLJIVA	47194	81.15210.0086	IZDU0206
5.	CEV	48120	81.15204.0527	IZDU0326
6.	CEV	48150	81.15205.5177	IZDU0499
7.	ŠELNA	99714	81.97420.0085	IZDU0320
8.	ŠELNA	49939	06.67419.0004	IZDU0335

TG EURO V

ELEMENTI IZDUVNOG SISTEMA - TG EURO V

Poz.	Naziv	Dinex broj	OE broj	RAPIDEX broj
1.	LONAC	47330	81.15103.0035	IZDU0500
2.	LONAC	47333	81.15103.6037	IZDU0501
3.	CEV	48222	81.15206.0002	IZDU0289
4.	CEV GIBLJIVA	48228	81.15206.5008	IZDU0272
5.	ŠELNA	68865	06.67419.0006	IZDU0502
6.	ŠELNA	99715	81.97420.0167	IZDU0503

2.0 KVAČILO I TRANSMISIJA

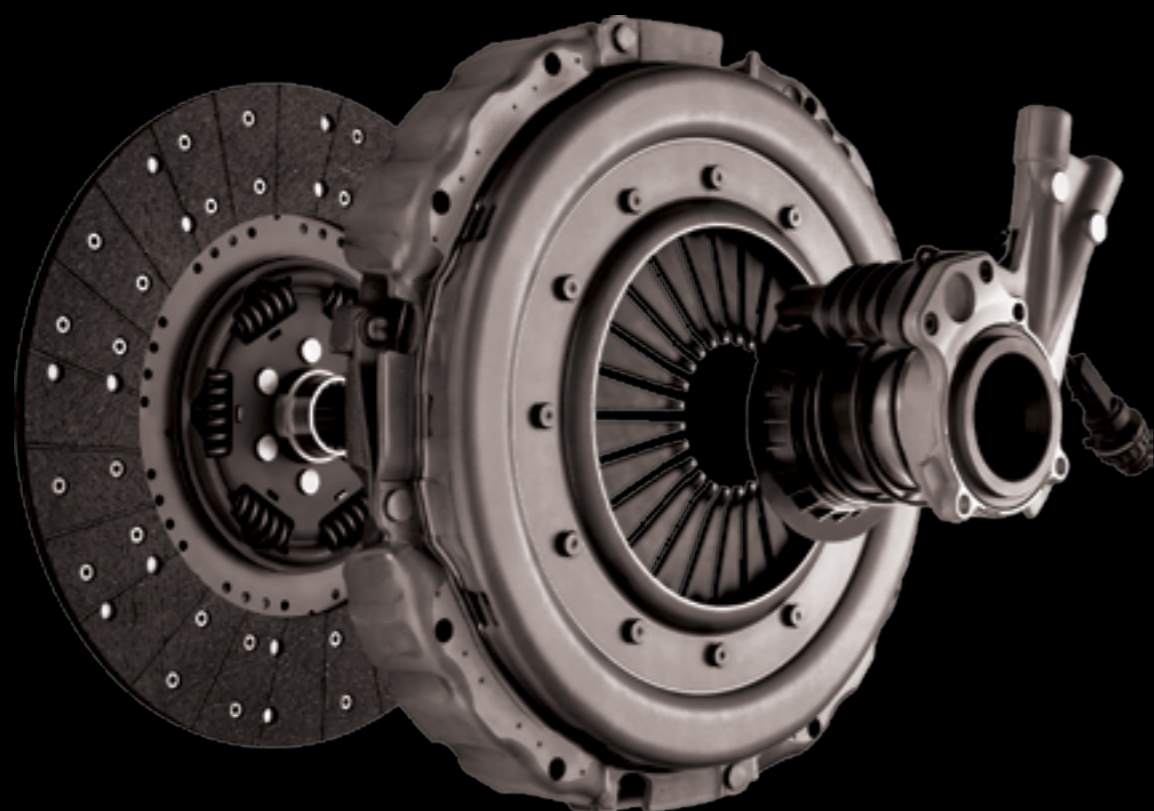

2.0 KVAČILO I TRANSMISIJA

2.1 Setovi kvačila i elementi	56
2.2 Centralni ležajevi kardana	61
2.3 Cilindri menjača	62

SETOVI KVAČILA

Poz.	Model vozila	Prečnik	Broj zuba	KBP	OE broj	RAPIDEX broj
1.	L2000	Ø362 mm	10	3400 710 002	81.30005.9024	MENJ0239
2.	L2000, M2000, F2000, TGM	Ø362 mm	10	3400 121 801 (bez druk ležaja)	81.30005.9003	MENJ0261
3.	L2000, M2000, TGL	Ø362 mm	10	3400 700 303 (bez druk ležaja)	81.30005.9013	MENJ0291
4.	M2000	Ø395 mm	10	3400 710 003	81.30005.9025	MENJ0724
5.	F2000, TGL, TGM	Ø395 mm	10	3400 121 701	81.30000.9045	MENJ0298
6.	F90, F2000	Ø430 mm	10	3400 122 201	81.30005.9020	MENJ0184
7.	TGA	Ø430 mm	10	3400 127 401	81.30000.6582	MENJ0267
8.	TGA, TGX, TGS	Ø430 mm	10	3400 700 402	81.30000.6572	MENJ0265
9.	TGA, TGX, TGS	Ø430 mm	10	3400 700 403	81.30000.6579	MENJ0411
10.	TGA, TGX, TGS	Ø430 mm	10	3400 700 404	81.30000.6572	MENJ0233
11.	TGA, TGX, TGS	Ø430 mm	10	3400 700 381	81.30005.9032	MENJ0923
12.	TGA, TGX, TGS	Ø430 mm	10	3400 700 459	81.30005.9033	MENJ0714
13.	TGA, TGX, TGS	Ø430 mm	10	3400 700 460	81.30000.9036	KVAC0439
14.	TGA, TGX, TGS	Ø430 mm	10	3400 700 380	81.30005.9037	MENJ0922

POTISNI LEŽAJEVI

Poz.	Slika	Model vozila	KBP	OE broj	RAPIDEX broj
1.		LION'S STAR LION'S COACH	3151 000 157	36.30550.0003	MENJ0612
2.		8.192 14.192	3151 067 031	81.30550.0043	MENJ0210
3.		L2000	T7000.090	81.30550.0044	KVAC0082
4.		L2000, TGM	3182 005 231	81.30550.0074	MENJ0194
5.		BUS, TGL, TGM	T7000.28	81.30550.0052	MENJ0211
6.		F2000, TGA, TGS, TGX	3151 000 034	81.30000.6587	MENJ0282

POTISNI LEŽAJEVI

Poz.	Slika	Model vozila	KBP	OE broj	RAPIDEX broj
7.		M2000, TGA, TGL, TGM	3151 253 031	81.30550.0082	KVAC0262
8.		TGL	3182 600 142	81.30005.9039	MENJ0155
9.		TGA, TGS, TGX	3151 000 144	81.30550.0102	KVAC0062
10.		TGA, TGL, TGM TGS, TGX	3151 000 493	81.30550.0249	KVAC0289

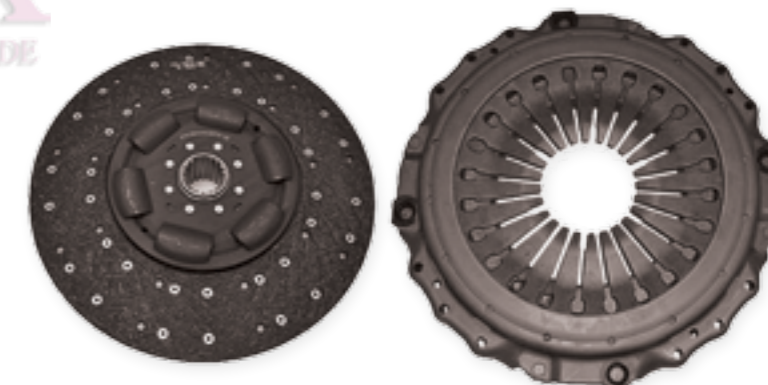
KORPE KVAČILA

Poz.	Model vozila	Prečnik	Tip	KBP	OE broj	RAPIDEX broj
1.	F9, F90	Ø420 mm	GF 420	1882 330 032	81.30305.0083	KVAC0175
2.	F90, F2000, TGM	Ø430 mm	MFZ 430	3482 083 032	81.30305.0193	KVAC0455
3.	F2000, TGA, TGX, TGS	Ø400 mm	MFZ2/400X	3488 017 447	81.30305.0228	MENJ0188
4.	TGA, TGX, TGS	Ø430 mm	MFZ 430	3482 000 361	81.30305.0230	KVAC0173
5.	F2000, TGA, TGX, TGS	Ø430 mm	MFZ 430	3482 000 246	81.30305.0229	KVAC0484

LAMELE KVAČILA

Poz.	Model vozila	Prečnik	Broj zuba	KBP	OE broj	RAPIDEX broj
1.	F2000	Ø430 mm	10	T1000.633	81.30301.0582	KVAC0019
2.	F2000, TGA	Ø400 mm	10	1862 539 031	81.30000.7220	MENJ0187
3.	F2000, TGM	Ø430 mm	10	1878 080 031	81.30301.0457	KVAC0296
4.	F2000, TGA, TGS, TGX	Ø400 mm	10	1878 002 643	81.30301.0539	MENJ0097
5.	F2000, TGA, TGS, TGX	Ø430 mm	10	1878 004 832	81.30301.0627	MENJ0243
6.	TGA, TGS, TGX	Ø430 mm	10	1878 002 139	81.30301.0527	MENJ0161
7.	TGA, TGS, TGX	Ø430 mm	10	1878 004 104	81.30301.0622	KVAC0485



ZAMAJCI

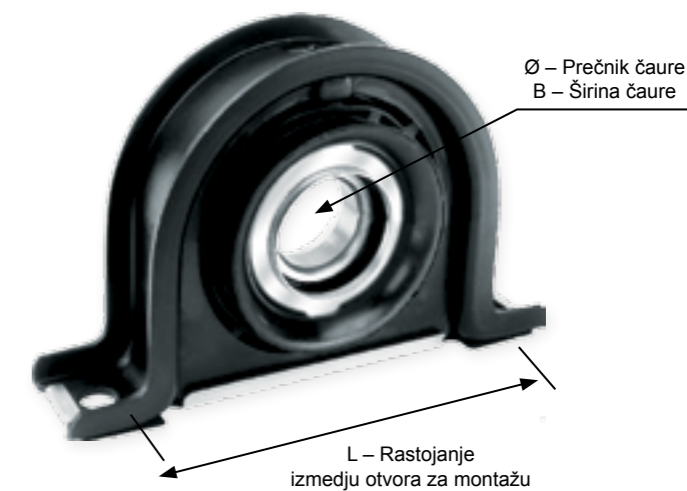

Poz.	Model vozila	Prečnik (mm)	KBP	OE broj	RAPIDEX broj
1.	M90, F90	Ø380 mm	T1001.050	51.02301.7290	MOTO0386
2.	M90, F90, F2000	Ø420 mm	T1001.060	51.02301.0307	MOTO0397
3.	F2000, TGA, TGS, TGX	Ø430 mm	T0912.060	51.02301.6033	MOTO0256
4.	TGA, TGS, TGX	Ø430 mm	T0912.110	51.02301.5259	MOTO1442
5.	TGA, TGS, TGX	Ø430 mm	3421 601 046	51.02301.5209	MOTO0098
6.	TGA, TGS, TGX	Ø430 mm	3421 601 044	51.02301.6034	MOTO0319
7.	TGA, TGS, TGX	Ø430 mm	3421 601 043	51.02301.6043	MOTO1575



CENTRALNI LEŽAJEVI KARDANA

Poz.	Slika	Model	Ø (mm)	B (mm)	L (mm)	OE broj	RAPIDEX broj
1.		TGA	85	13	220	81.39410.6031	MENJ0308
2.		TGA	75	20	230	81.39410.6020	MENJ0125
3.		TGA	75	20	220	81.39410.6021	MENJ0124
4.		F2000, F90, L2000, M2000, M90, TGA	65	23	230	81.39410.6019 81.39410.6017 81.39410.6013	MENJ0067
5.		L2000, M2000	100	13	193,5	81.39410.6018	MENJ0628

2

CILINDRI MENJAČA						
Poz.	Slika	Model vozila	Naziv	KBP	OE broj	RAPIDEX broj
1.		TGA, TGX	BIRAČ BRZINA	627496AM	81.30605.6111	MENJ0074
2.		TGA, TGX	CILINDAR MENJAČA	629218AM	81.32655.6181	MENJ0072
3.		TGA, TGX	CILINDAR MENJAČA	629219AM	81.32655.6182	MENJ0073

2

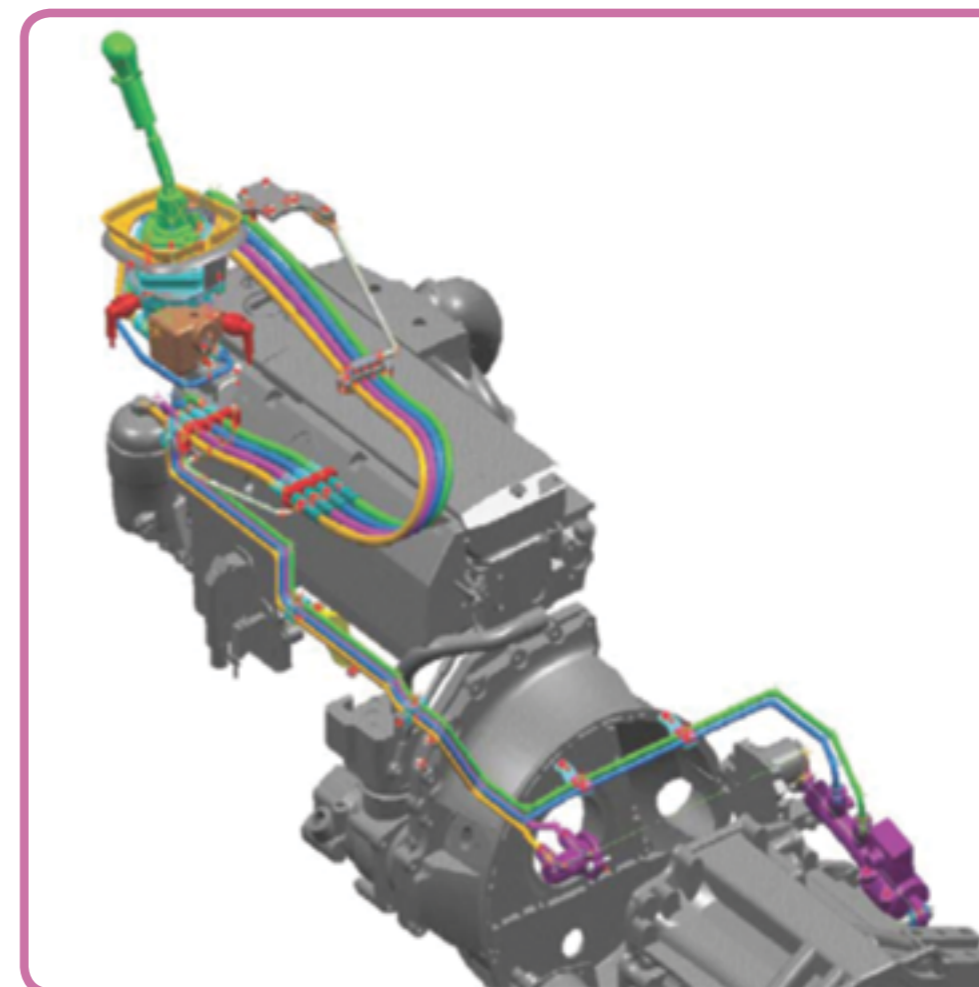

3.0 KOČIONA PNEUMATIKA I HIDRAULIKA

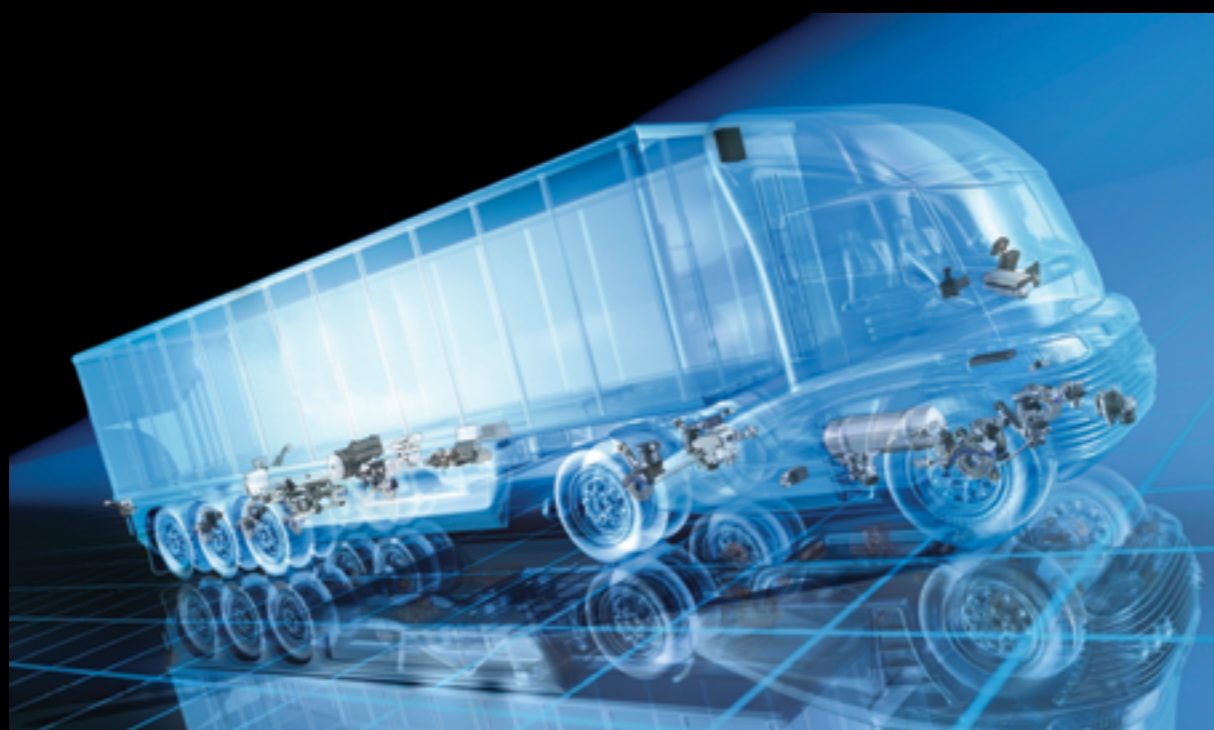

3.0 KOČIONA PNEUMATIKA I HIDRAULIKA

3.1	Kompresori i delovi	66
3.2	Isušivači vazduha i filteri	67
3.3	Ventili kočionog sistema	70
3.4	Ventili ogibljenja	81
3.5	Cilindri tristop i membranski	82
3.6	Ventili ABS, EBS i ECAS	84
3.7	Elektronika ECAS	89
3.8	Senzori	90
3.9	Cilindri kvačila	93
3.10	Pribor kočionog sistema	97
3.11	WABCO i WABCOWÜRTH dijagnostika	105

KOMPRESORI					
Poz.	Slika	WABCO broj / Knorr broj	Model / Opis	OE broj	RAPIDEX broj
1.		411 147 062 0	F90	51.54101.7192	KOCN1146
2.		412 352 003 0	TGL	51.54100.7005	KOCN0456
3.		LP3980	TGA D2066	51.54100.7121	KOCN3461

GLAVE KOMPRESORA					
Poz.	Slika	KBP	Model / Opis	Aparat / OE broj	RAPIDEX broj
1.		V130116	F2000	51.54114.6070	KOCN1976
2.		412 090 803 2	TGA D2876	51.54114.6081	KOCN0952
3.		-	TGA D2086	51.54114.6084	KOCN2461

ISUŠIVAČI VAZDUHA					
Poz.	Slika	WABCO broj / Haldex broj	Model / Opis	OE broj	RAPIDEX broj
1.		432 410 104 0	F90, UNIVERZALAN 8,1 bar	-	KOCN0029
2.		432 410 127 0	F90, UNIVERZALAN 8,1 bar	-	KOCN0103
3.		432 410 250 0	L2000, UNIVERZALAN 10 bar	-	KOCN1115
4.		432 432 002 0	BUS DVOKOMORNI 10 bar	81.52102.6095	KOCN0589
5.		432 432 199 0	NEOPLAN, UNIVERZALAN DVOKOMORNI 10 bar	81.52102.6017	KOCN0707

ISUŠIVAČI VAZDUHA					
Poz.	Slika	WABCO broj / Haldex broj	Model / Opis	OE broj	RAPIDEX broj
6.		432 410 034 0	F2000, TG, UNIVERZALAN 12,5 bar	-	KOCN0844
7.		432 410 720 0	TG 12,5 bar	81.52102.6209	KOCN2424
8.		432 410 735 0	TG 12,5 bar	81.52102.6217	KOCN2425
9.		950 310 014	TG ECAM 12,5 bar	81.52108.6026	KOCN1334

FILTERI ISUŠIVAČA VAZDUHA					
Poz.	Slika	WABCO broj	Model	Opis	RAPIDEX broj
1.		432 410 222 0	UNIVERZALNI	M39 x 1,5 mm	KOCN0894
2.		432 901 223 2	UNIVERZALNI	NOVI TIP, M39 x 1,5 mm	KOCN0923







ČETVOROKRUŽNI / ŠESTOKRUŽNI ZAŠTITNI VENTILI

Poz.	Slika	WABCO broj	Model	Opis	OE broj	RAPIDEX broj
1.		934 702 041 0	F90	M22/M16, MAX 10 bar, 7/6,5 bar	81.52151.6013	KOCN1121
2.		934 702 221 0	F90	M22/M16, MAX 20 bar, 7 bar	81.52151.6020	KOCN1339
3.		934 714 119 0	F2000	M22/M16, MAX 13 bar, 7,5 bar	-	KOCN1114
4.		934 714 400 0	TGA	M22/M16, MAX 13 bar, 7,5 bar	81.52151.6098	KOCN0028
5.		AE4613	TGA	M22/M16, MAX 13 bar, 7,5 bar	81.52151.6093	KOCN3305
6.		934 714 110 0	TGA, TGS, TGX	M22/M16, MAX 13 bar, 7,5 bar	81.52151.6094	KOCN2383

VENTILI RELEJNI

Poz.	Slika	WABCO broj	Model	OE broj	RAPIDEX broj
1.		973 001 010 0	F90	81.43609.6008	KOCN1354
2.		973 011 001 0	F2000	81.52116.6070	KOCN0549
3.		973 006 001 0	TGA	81.52116.6067	KOCN1229
4.		973 003 007 0	TGA	81.52116.6078	KOCN3268
5.		973 011 250 0	TGA	81.52116.6079	KOCN2049



VENTILI OGRANIČENJA PRITISKA

Poz.	Slika	WABCO broj	Model	Izlazni / Ulazni pritisak	OE broj	RAPIDEX broj
1.		475 015 004 0	F90, F2000, TGA	3,5 - 8 bar	81.52101.6153	KOCN1744
2.		475 010 333 0	TGA, TGL	9,3 - 12,5 bar	81.52101.6295	KOCN2169
3.		475 010 300 0	TGA	8,5 - 10 bar	81.52101.6269	KOCN0865
4.		475 010 301 0	TGA	10 - 12,5 bar	81.52101.6270	KOCN0724
5.		475 010 314 0	TGA	7 - 10 bar	81.52101.6283	KOCN0750



VENTILI BRZOG ISPUSTA

Poz.	Slika	WABCO broj	Model	Opis	OE broj	RAPIDEX broj
1.		973 500 000 0	-	M22 x 1,5 mm	81.52115.6009	KOCN1273
2.		973 500 028 0	-	M22 x 1,5 23M16 VOSS	-	KOCN1141
3.		973 500 038 0	-	M 22 x 1,5 mm M16	-	KOCN0501
4.		973 500 042 0	-	M 22 x 1,5 mm VOSS	81.52170.6140	KOCN0702
5.		973 500 051 0	-	INTERGISAN DUPLI	-	KOCN0997

DVOSMERNI VENTILI

Poz.	Slika	WABCO broj	Model	OE broj	RAPIDEX broj
1.		434 202 000 0	UNIVERZALNI	-	KOCN1280
2.		434 208 000 0	UNIVERZALNI	-	KOCN0590
3.		434 208 029 0	UNIVERZALNI	-	KOCN0888

PRELIVNI VENTILI

Poz.	Slika	WABCO broj	Model	OE broj	RAPIDEX broj
1.		434 100 125 0	UNIVERZALNI	81.52110.6058	KOCN0766
2.		434 100 130 0	UNIVERZALNI	81.52110.6045	KOCN2472
3.		434 100 228 0	UNIVERZALNI	81.52110.6092	KOCN2631

VENTIL RAZVODNIK

Poz.	Slika	WABCO broj	Model	OE broj	RAPIDEX broj
1.		463 036 000 0	UNIVERZALNI	-	KOCN1674
2.		463 036 001 0	UNIVERZALNI	-	KOCN1086

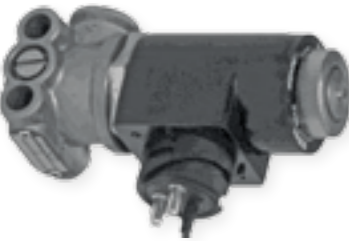

ELEKTROMAGNETNI VENTILI

Poz.	Slika	WABCO broj	Model	OE broj	RAPIDEX broj
1.		472 132 198 0	F90, L2000	81.52160.6087	KOCN1179
2.		472 133 158 0	F90, L2000	81.52160.6093	KOCN0701
3.		472 170 604 0	F90, NEOPLAN	84.52160.6032	KOCN1139
4.		472 172 604 0	NEOPLAN	81.52160.6092	KOCN0992
5.		472 171 428 0	F90, F2000	81.52160.6114	KOCN1007

ELEKTROMAGNETNI VENTILI

Poz.	Slika	WABCO broj	Model	OE broj	RAPIDEX broj
6.		472 173 704 0	F90, F2000	81.52160.6140	KOCN0990
7.		472 173 428 0	M2000, TGA	81.52160.6125	KOCN1287
8.		472 070 628 0	F2000, TGA	81.52160.6118	KOCN0981
9.		472 072 628 0	F2000, TGA	81.52160.6115	KOCN0476



VENTILI PEDALE KOČNICE

Poz.	Slika	WABCO broj	Model	OE broj	RAPIDEX broj
1.		461 318 003 0	F90, F2000	81.52130.6095	KOCN1124
2.		461 316 002 0	F90, F2000	81.52130.9128	KOCN0983
3.		461 317 041 0	F90, F2000	81.52320.6112	KOCN2179



NAGAZNI VENTILI MOTORNE KOČNICE

Poz.	Slika	WABCO broj	Model	OE broj	RAPIDEX broj
1.		463 013 116 0	F90, F2000	81.52185.6009	KOCN1355

VENTILI RUČNE PARKIRNE KOČNICE

Poz.	Slika	WABCO broj	Model/Opis	OE broj	RAPIDEX broj
1.		961 723 405 0	F90, F2000	81.52315.6136	KOCN0435
2.		961 722 262 0	F90, NEOPLAN	81.52315.6086	KOCN1130
3.		961 723 118 0	L2000, F2000, TGA	81.52315.6161	KOCN1009

VENTILI UPRAVLJANJA PRIKOLICE

Poz.	Slika	WABCO broj	Model	OE broj	RAPIDEX broj
1.		973 002 521 0	F90, F2000	81.52301.6120	KOCN1331
2.		973 009 006 0	L2000, M2000, F2000, TGA, TGL, TGS, TGM, TGX	81.52301.6189	KOCN1246

VENTILI INTARDERA

Poz.	Slika	WABCO broj	Model	OE broj	RAPIDEX broj
1.		-	TGA, TGS, TGX	81.32550.0011	MENJ1134



VENTILI NIVELACIJE KABINE

Poz.	Slika	WABCO broj	Model	OE broj	RAPIDEX broj
1.		464 007 001 0	F90, F2000, TGA, TGS, TGX	81.43610.6129	VESA0716



TRISTOP CILINDRI



Poz.	WABCO broj / Knorr broj	Model	Opis	OE broj	RAPIDEX broj
1.	925 490 925 0	F90, F2000, UNIVERZALNI	20/24	-	KOCN0989
2.	925 491 141 0	F90, F2000, UNIVERZALNI	24/24	-	KOCN1084
3.	925 492 102 0	F90, F2000, UNIVERZALNI	TIP 30"	-	KOCN1528
4.	925 325 118 0	F90, F2000	12/12	81.50410.6475	KOCN1191
5.	925 326 000 0	F90, F2000	14/12	81.50410.6391	KOCN0492
6.	925 426 200 0	L2000	14/16	81.50410.6579	KOCN0998
7.	BS9093	TGA	10/16	81.50410.6779	KOCN1193
8.	925 424 800 0	L2000, TGL	16/16	81.50410.6581	KOCN2266
9.	925 460 230 0	TGA, TGS, TGX	20/24	81.50410.9733	KOCN0861
10.	925 460 231 0	TGA, TGS, TGX	20/24	81.50410.9732	KOCN1980





MEMBRANSKI CILINDRI

Poz.	WABCO broj / Knorr broj	Model	Opis	OE broj	RAPIDEX broj
1.	423 106 700 0	TGA	DISK TIP 24	81.51101.6434	KOCN3506
2.	423 106 701 0	TGA	DISK TIP 24	81.51101.6435	KOCN3505



MEMBRANE TRISTOP CILINDRA

Poz.	WABCO broj	Tip	Prečnik x Visina	RAPIDEX broj
1.	897 120 495 4	TIP 9	Ø128 x 31 mm	KOCN1555
2.	897 120 505 4	TIP 12 P	Ø139 x 31 mm	KOCN1259
3.	897 120 510 4	TIP 16 P	Ø156 x 35 mm	KOCN3087
4.	897 120 516 4	TIP 16 D	Ø158 x 43 mm	KOCN3086
5.	897 120 520 4	TIP 20 P	Ø128 x 31 mm	KOCN3089
6.	897 120 526 4	TIP 20 D	Ø168 x 38 mm	KOCN3088
7.	897 120 530 4	TIP 24 P	Ø179 x 33 mm	KOCN1231
8.	897 120 535 4	TIP 24 S	Ø179 x 40 mm	KOCN1224
9.	897 120 536 4	TIP 24 D	Ø179 x 45 mm	KOCN3125
10.	897 120 540 4	TIP 30 P	Ø199 x 35 mm	KOCN3095
11.	897 120 546 4	TIP 30 D	Ø200 x 44 mm	KOCN3094
12.	897 121 610 4	TIP 14 P	Ø139 x 28 mm	KOCN3085
13.	897 121 923 4	TIP 12 D	Ø162 x 43 mm	KOCN0926

ABS RELEJNI VENTILI					
Poz.	Slika	WABCO broj	Model	OE broj	RAPIDEX broj
1.		472 195 016 0	UNIVERZALNI	81.52452.6019	KOCN0551
2.		472 195 018 0	UNIVERZALNI	-	KOCN1164
3.		472 195 009 0	F2000, TGA	81.52452.6014	KOCN0820

ADAPTER KABEL ABS VENTILA					
Poz.	Slika	WABCO broj	Model	OE broj	RAPIDEX broj
1.		894 601 132 2	UNIVERZALNI	-	KOCN1154
2.		894 601 133 2	UNIVERZALNI	-	KOCN1156
3.		894 601 134 2	UNIVERZALNI	-	KOCN0251

EBS VENTILI					
Poz.	Slika	Knorr broj	Model / Opis	OE broj	RAPIDEX broj
1.		0 486 203 023	TGA	81.52106.6001	KOCN1158
2.		0 486 204 017	TGA	81.52106.6000	KOCN0834
3.		K000921	TGA, TGS, TGX	81.52106.6042	KOCN1306
4.		K020623N50	TGA, TGS, TGX	81.52301.6213	KOCN2066
5.		K000913	TGA, TGS, TGX	81.52106.6041	KOCN0833

EBS VENTILI					
Poz.	Slika	Knorr broj	Model / Opis	OE broj	RAPIDEX broj
6.		0 486 200 007	TGA, TGS, TGX	81.52130.6268	KOCN1823
7.		K039569N50	TGA, TGS, TGX	81.52130.6275	KOCN2699



ECAS ELEKTROMAGNETNI VENTIL					
Poz.	Slika	WABCO broj	Model / Opis	OE broj	RAPIDEX broj
1.		472 900 001 7	L2000	81.25902.6154	KOCN1166
2.		472 900 053 0	L2000, M2000, F2000, TGA, TGL	81.25902.9146	VESA1050
3.		472 900 054 0	F2000, TGA, TGS, TGX	81.25902.9144	VESA0648
4.		472 900 055 0	L2000, M2000, F2000, TGA, TGM, TGS, TGX	81.25902.9145	VESA0426
5.		472 900 057 0	L2000, M2000, F2000, TGA, TGM, TGS, TGX	81.25902.9158	VESA1051

ECAS ELEKTROMAGNETNI VENTIL

Poz.	Slika	WABCO broj	Model	OE broj	RAPIDEX broj
6.		472 905 111 0	L2000, M2000, F2000, TGA, TGM, TGS, TGX	81.25902.9147	VESA0612
7.		472 900 050 0	AUTOBUS	81.25902.6118	VESA0746
8.		472 900 056 0	AUTOBUS	81.25902.6168	VESA1339



ECAS RUČNA KOMANDA - TELEKOMADA

Poz.	WABCO broj	Model	Opis	OE broj	RAPIDEX broj
1.	446 056 127 0	L2000, M2000, F2000	F/A, R/A, L/AXLE	81.25505.6398	VESA1273
2.	446 056 139 0	TGA, TGS, TGX	F/A, R/AXLE	81.25505.6601	VESA0661



ELEKTRONIKA ECAS - CENTRALA

Poz.	WABCO broj	Model	Opis	OE broj	RAPIDEX broj
1.	446 055 302 0	L2000, F2000	4 x 2 / 6 x 2 25 - PINSKI	81.25935.6712	VESA0519
2.	446 055 301 0	F2000	4 x 2 / 6 x 2 25 - PINSKI	81.25935.6713	VESA0411
3.	446 055 409 0	F2000	6 x 2 35 - PINSKI	81.25935.6830	VESA1059
4.	446 170 053 0	TGA	6 x 2 18/15 - PINSKI	81.25811.7011	VESA0521
5.	446 055 055 0	BUS	4 x 2 35 - PINSKI	81.25935.6582	VESA0681



SENZORI ABS

Poz.	WABCO broj / Knorr broj	Model	Opis	OE broj	RAPIDEX broj
1.	441 032 288 0	TGM, NEOPLAN	ZADNJI	81.27120.6186	KOCN0247
2.	441 032 289 0	TGM, NEOPLAN	ZADNJI	81.27120.6187	KOCN0248
3.	441 032 291 0	TGM	PREDNJI	81.27120.6189	KOCN1313
4.	441 032 265 0	TGA, TGX	ZADNJI	81.27120.6121	KOCN0347
5.	441 032 266 0	TGA, TGX	ZADNJI	81.27120.6122	KOCN0348
6.	441 032 296 0	TGA, TGS, TGX	ZADNJI LEVI 2070 mm	81.27120.6182	KOCN1253
7.	441 032 297 0	TGA, TGS, TGX	ZADNJI DESNI 2070 mm	81.27120.6183	KOCN2110
8.	441 032 298 0	TGA, TGS, TGX	ZADNJI LEVI 2595 mm	81.27120.6184	KOCN2112
9.	441 032 299 0	TGA, TGS, TGX	ZADNJI DESNI 2595 mm	81.27120.6185	KOCN2111
10.	0 486 000 250	TGA, TGS, TGX	PREDNJI LEVI 1500 mm	81.27120.6131	KOCN3032
11.	0 486 000 251	TGA, TGS, TGX	PREDNJI DESNI 1500 mm	81.27120.6132	KOCN3031

PRODUŽNI KABEL SENZORA

Poz.	WABCO broj	Opis	RAPIDEX broj
1.	449 712 008 0	DUŽINA 800 mm	KOCN1655
2.	449 712 018 0	DUŽINA 1800 mm	KOCN0891
3.	449 712 030 0	DUŽINA 3000 mm	KOCN1107
4.	449 712 051 0	DUŽINA 5100 mm	KOCN0719
5.	449 712 060 0	DUŽINA 6000 mm	KOCN0886
6.	449 712 120 0	DUŽINA 12000 mm	KOCN0973

PREKIDAČI PRITISKA

Poz.	Slika	WABCO broj	Opis	OE broj	RAPIDEX broj
1.		441 009 101 0	UNIVERZALNI	-	VESA0642
2.		441 014 006 0	UNIVERZALNI	-	KOCN1658
3.		441 014 010 0	UNIVERZALNI	-	VESA0488
4.		441 014 501 0	UNIVERZALNI	-	KOCN2797
5.		441 014 025 0	UNIVERZALNI	-	VESA0674

SENZOR PRITISKA

Poz.	Slika	WABCO broj	Model / Opis	OE broj	RAPIDEX broj
1.		441 044 101 0	UNIVERZALNI 10 bar	81.27421.0268	KOCN0752
2.		-	TGA, TGS, TGX	81.27421.6047	KOCN3481

SENZORI ECAS-a					
Poz.	Slika	WABCO broj	Model	OE broj	RAPIDEX broj
1.		441 050 006 0	F90, L2000	81.25937.0014	VESA0739
2.		441 050 011 0	M2000, F2000	81.25937.0016	VESA0747
3.		441 050 012 0	TGA, TGS, TGX	81.25937.0023	VESA0727
4.		441 050 120 0	TGA, TGS, TGX	81.25937.0040	ELEK0244
5.		441 050 123 0	TGA, TGS, TGX	81.25937.0040	VESA0745

SERVO CILINDRI KVAČILA					
Poz.	Slika	WABCO broj / Knorr broj	Model	OE broj	RAPIDEX broj
1.		970 051 111 0	M90	81.30725.6026	KVAC0140
2.		462 012 101 0	F90	81.30725.6005	KVAC0178
3.		970 051 157 0	F90, F2000	81.30725.6055	KVAC0138
4.		970 051 406 0	M2000, L2000	81.30725.6069	KVAC0117
5.		970 051 414 0	F2000	81.30725.6064	KVAC0133

SERVO CILINDRI KVAČILA

Poz.	Slika	WABCO broj / Knorr broj	Model	OE broj	RAPIDEX broj
6.		970 051 412 0	F2000, TGA	81.30725.6084	KVAC0126
7.		970 051 458 0	TGL	81.30725.6114	KVAC0482
8.		970 051 432 0	TGA, TGL, TGM	81.30725.6108	KVAC0406
9.		970 051 466 0	TGA, TGL, TGM	81.30725.6116	KVAC0036
10.		0 483 005 005	TGA, TGS, TGX	81.30716.6102	MENJ0760

PRIMARNI CILINDRI KVAČILA

Poz.	Slika	Model	KBP	Opis / Odlivak	OE broj	RAPIDEX broj
1.		G90	KG 19080.1.3	Ø19,05 mm S 5310	81.30715.6124	KVAC0071
2.		G90	KG 25794.1.3	Ø25,4 mm S 5346	81.30715.6116	KVAC0095
3.		M90, F90, F2000	KG 23027.0.1	Ø23,81 mm S 5500	81.30715.6111	KVAC0236
4.		F90, F2000	KG 2597.1.1	Ø25,4 mm S 5500	81.30715.6108	KVAC0237
5.		F2000	KG 22028.0.2	Ø23,81 mm S 5571	81.30715.6135	KVAC0201

PRIMARNI CILINDRI KVAČILA						
Poz.	Slika	Model	KBP	Opis / Odlivak	OE broj	RAPIDEX broj
6.		TGL	974 010 008 0	--	81.30700.6020	KVAC0473
7.		TGA	MKG 23852.4.2	Ø23,81/40 mm PLASTIKA	81.30715.6154	KVAC0076
8.		SL II BUS	KG 2590.1.1	Ø25,4 mm S 5126	81.30715.6030	KVAC0202



CREVA VAZDUHA					
Poz.	KBP	Opis	Dužina	Boja	RAPIDEX broj
1.	KG685091	SPIRALNO M16 x 1,5 mm	4,5 m	crveno	KOCN2940
2.	KG685087	SPIRALNO M16 x 1,5 mm	4,5 m	zuto	KOCN2939

SPOJNE GLAVE				
Poz.	Slika	WABCO broj	Opis	RAPIDEX broj
1.		452 802 007 0	DUOMATIC - BRZA, M16 x 1,5 mm	KOCN0743
2.		452 802 009 0	DUOMATIC - BRZA sa ABE, M16 x 1,5 mm	KOCN1044
3.		452 803 005 0	DUOMATIC - BRZA, PRIKLJUČAK ABE, M16 x 1,5 mm	KOCN0521
4.		452 804 012 0	DUOMATIC - BRZA, VUČNO VOZILO, M16 x 1,5 mm	KOCN1043
5.		452 805 004 0	DUOMATIC - BRZA, M16 x 1,5 mm	KOCN0520
6.		952 200 021 0	M16 mm, CRVENA, PRIKOLICA	KOCN1345

SPOJNE GLAVE				
Poz.	Slika	WABCO broj	Opis	RAPIDEX broj
7.		952 200 022 0	M16 mm, ŽUTA, PRIKOLICA	KOCN1346
8.		952 200 221 0	M16 mm, CRVENA, KAMION	KOCN1347
9.		952 200 222 0	M16 mm, ŽUTA, KAMION	KOCN1357
10.		952 201 001 0	SA FILTEROM, M16 mm, ŽUTA, max 8,5 bar	KOCN0827
11.		952 201 002 0	SA FILTEROM, M16 mm, CRVENA, max 8,5 bar	KOCN0826



CREVA VAZDUŠNE INSTALACIJE				
Poz.	Opis	Dužina	KBP	RAPIDEX broj
1.	4 x 1,0 mm	25 m	T 7300.15	KOCN3581
2.	5 x 1,0 mm	25 m	T 7300.27	KOCN0885
3.	6 x 1,0 mm	25 m	T 7300.01	KOCN3631
4.	8 x 1,0 mm	25 m	T 7300.02	KOCN3542
5.	9 x 1,5 mm	25 m	T 7300.14	KOCN0853
6.	10 x 1,0 mm	25 m	T 7300.03	KOCN1072
7.	12 x 1,5 mm	25 m	T 7300.04	KOCN3802
8.	15 x 1,5 mm	25 m	T 7300.05	KOCN1070
9.	18 x 2,0 mm	25 m	T 7300.20	KOCN1069
10.	NW 11 x 3,5 mm	40 m	T 7299.97	KOCN3777
11.	NW 13 x 6,0 mm	40 m	T 7299.98	KOCN3740
12.	NW 15 x 5,0 mm	40 m	T 7299.96	KOCN0902



SPOJNICE CREVA			
Poz.	WABCO broj	Opis	RAPIDEX broj
1.	893 129 401 2	CREVO 11 x 3,5 mm, M16 x 1,5 mm	OSTA0257
2.	893 129 402 2	CREVO 11 x 3,5 mm, M22x1,5 mm	OSTA0256
3.	893 129 403 2	CREVO 13 x 6 mm, M16x1,5 mm	OSTA0255
4.	893 129 404 2	CREVO 13 x 6 mm, M22x1,5 mm	OSTA0254
5.	893 226 682 2	UTIČNICA VOSS NG8 WABCO	OPRE0209
6.	893 226 689 2	ADAPTER M16 VOSS SA 232 NA 230	OPRE0021
7.	893 226 690 2	ADAPTER M22 VOSS SA 232 NA 230	OPRE0022
8.	893 800 005 2	CREVO 8 x 1 mm, M22 x 1,5 R mm	OSTA0176
9.	893 800 009 2	CREVO 10 x 1 mm, M16 x 1,5 mm	OSTA2213
10.	893 803 890 0	CREVO10 x 1 mm, M22 x 1,5 mm	OSTA1249
11.	893 800 002 2	CREVO 12 x 1,5 mm, M16 x 1,5 mm	OSTA0476
12.	893 800 008 2	CREVO 12 x 1,5 mm, M22 x 1,5 mm	OSTA0485
13.	893 800 004 2	CREVO 15 x 1,5 mm, M22 x 1,5 mm	OSTA1087
14.	893 800 007 2	CREVO 8 x 1 mm, M12 x 1,5 mm	OSTA0483
15.	893 800 001 2	CREVO 8 x 1 mm, M16 x 1,5 mm	OSTA0482

SPOJNICE CREVA			
Poz.	WABCO broj	Opis	RAPIDEX broj
16.	893 803 022 0	CREVO 6 x 1 mm, M12 x 1,5 mm	OSTA1170
17.	893 800 003 2	CREVO 16 x 2 mm, M22 x 1,5 mm	OSTA0484
18.	893 803 035 0	CREVO 6 x 2 mm, M10 x 1,5 mm	OSTA1171
19.	893 803 780 0	CREVO 15 x 2 mm, M22 x 1,5 mm	OSTA0262
20.	893 831 223 0	CREVO 6 x 1 mm, M12 x 1,5 mm, pod uglom	OSTA0477
21.	893 831 291 0	CREVO 8 x 1 mm, M12 x 1,5 mm, pod uglom	OSTA1570
22.	893 831 293 0	CREVO 8 x 1 mm, M16 x 1,5 mm, pod uglom	OSTA1136
23.	893 831 292 0	CREVO 8 x 1 mm, M22 x 1,5 mm, pod uglom	OSTA0480
24.	893 831 295 0	CREVO 12 x 1,5 mm, M16 x 1,5 mm, pod uglom	OSTA1764
25.	893 831 215 0	CREVO 15 x 1,5 mm, M16 x 1,5 mm, pod uglom	OSTA1901



KUTIJA SA SPOJNICAMA	
WABCO broj	RAPIDEX broj
893 000 200 0	OSTA1115



SPOJNICE CREVA

Slika	Poz.	Opis	KBP	RAPIDEX broj
	1.	4 mm	T 7820.00	KOCN1102
	2.	5 mm	T 7820.01	KOCN1101
	3.	6 mm	T 7820.02	KOCN1100
	4.	8 mm	T 7820.03	KOCN1099
	5.	10 mm	T 7820.04	KOCN1098
	6.	12 mm	T 7820.05	KOCN1097
	7.	15 mm	T 7820.06	KOCN1096
	8.	22 mm	T 7820.08	KOCN1095
	9.	4 mm	T 7830.00	KOCN1029
	10.	5 mm	T 7830.01	KOCN1710
	11.	6 mm	T 7830.02	KOCN1028
	12.	8 mm	T 7830.03	KOCN1027
	13.	10 mm	T 7830.04	KOCN1026
	14.	12 mm	T 7830.05	KOCN1025
	15.	15 mm	T 7830.06	KOCN1709
	16.	4 mm	T 7840.00	KOCN1022
	17.	5 mm	T 7840.01	KOCN1713
	18.	6 mm	T 7840.02	KOCN1021
	19.	8 mm	T 7840.03	KOCN1020
	20.	10 mm	T 7840.04	KOCN1019
	21.	12 mm	T 7840.05	KOCN1018
	22.	15 mm	T 7840.06	KOCN1714

ALAT ZA BRZE SPOJNICE

Poz.	Slika	WABCO broj	Opis	OE broj	RAPIDEX broj
1.		899 700 001 4	8 x 1,5 mm	-	OSTA0716
2.		899 700 002 4	12 x 1,5 mm	-	OSTA0717
3.		899 700 003 4	15 x 1,5 / 16 x 2	-	OSTA0718

PRIGUŠIVAČI ZVUKA

Poz.	Slika	WABCO broj	Opis	OE broj	RAPIDEX broj
1.		432 407 012 0	Ø87 x 62 mm	81.52101.6264	KOCN0746
2.		432 407 060 0	Ø69 x 56,5 mm	81.52101.6274	KOCN0858
3.		432 407 070 0	Ø69 x 53 mm	81.52101.6275	KOCN0859

RAPIDEX

TRADE



TEČNOST PROTIV SMRZAVANJA INSTALACIJA

Poz.	WABCO broj	Opis	RAPIDEX broj
1.	830 702 087 4	WABCOTIL 1/1	ULJA0042
2.	830 702 090 4	WABCOTIL 200/1	ULJA0043



DIJAGNOSTIKA
Hardver & Softver

WABCO

Dok je ranijih godina za dijagnostiku svakog sistema na komercijalnim vozilima bio potreban poseban dijagnostički uređaj, danas je dovoljno posedovati JEDAN da bi se uspešno rešavali problemi kako različitih SITEMA tako i različitih proizvođača VOZILA

WABCO u svojoj ponudi raspolaže sa DVA RAZLIČITA dijagnostička sistema:

- WABCO SD sistem - WABCO SISTEMSKA DIJAGNOSTIKA
- WABCO & WÜRTH sistem.

Za svaku od ovih sistema nudimo neophodnu OPREMU, PROGRAME i što je velika retkost: OBUKU.



WABCO & WÜRTH - DIJAGNOSTIČKI SISTEM

Ovaj DIJAGNOSTIČKI UREĐAJ predstavlja najsavremeniju UNIVERZALNU DIJAGNOSTIČKU ALATKU na tržištu sa nebrojeno mnogo funkcija i mogućnosti kako za rad, tako i za PERSONALIZACIJU - prema potrebama samog korisnika.

Sam sistem se može dobiti u dve osnovne varijante:

- SA SD WABCO DIJAGNOSTIKOM
- BEZ SD WABCO DIJAGNOSTIKE

Dalje je moguća podela po delokrugu rada na:

- KOMPLETAN PAKET (SISTEMI KAMIONA, PRIKOLICE I BUS-a, LAKI TERETNI PROGRAM)
- KAMIONSKI PAKET
- PRIKOLIČNI PAKET
- BUS PAKET



WABCO & WÜRTH - DIJAGNOSTIČKI SISTEM

Sistemi na vozilima koji se mogu kontrolisati sa ovim uređajima su:

- KOČIONI SISTEM
- MENJAČ
- MOTOR
- ELEKTRIČNE INSTALACIJE
- GREJANJE I HLAĐENJE
- UPRAVLJANJE I VEŠANJE

Zbog stalnog usavršavanja i dopunjavanja teško je definisati krajnje mogućnosti rada ovog uređaja te zbog toga  omogućava proveru mogućnosti uređaja - PREZENTACIJU SVAKOM ZAJNTERESOVANOM KLIJENTU kod njega na vozilima koja klijent odabere.

SVI ZAJNTERESOVANI MOGU ZAKAZATI BESPLATNU PREZENTACIJU PREKO FIRME „RAPIDEX TRADE“ TE ĆE STRUČNI LJUDI  UBRZO STUPITI U KONTAKT SA ZAJNTERESOVANIMA.

Više informacija se može dobiti na: <http://www.wabcowuerth.com>



WABCO **SD - SISTEMSKA DIJAGNOSTIKA**

Za SD dijagnostiku WABCO sistema koristi se sledeća oprema:

- KOFER ZA PROVERU PNEUMATSKE KOČIONE INSTALACIJE
- KOFERI SA DIJAGNOSTIČKOM OPREMOM
- PAKETI DIJAGNOSTIČKIH PROGRAMA

WABCO SD - OPREMA

• Kofer za dijagnostiku pneumatske kočione instalacije



W: 435 002 007 0
R: KOCN1763

• Kofer za dijagnostiku prikoličnih sistema **W: 446 301 023 0** **R: KOCN0837**

Sadržaj kofera za dijagnostiku sistema na prikolicama i poluprikolicama:

- Diagnostic Interface
- Trailer Standardkabel
- CAN Adapter
- CAN Adapterkabel
- VCS I
- VCS II
- TEBS C / D



• Kofer za dijagnostiku sistema na kamionima **W: 446 301 025 0** **R: KOCN1764**

Sadržaj kofera za dijagnostiku sistema na kamionima:

- Adapter 35-pol EPS
- Kabel MB Actros/Citaro
- Kabel EBS Euro Neoplan
- Kabel MAN-TGA
- Kabel EBS IVECO Stralis
- Kabel ABS-D
- Kabel EBS DAF
- Kabel Actros MPII (OBD II)
- Kabel ECAS
- Kabel 15-pol. DAF, Scania, MAN (OBD II)
- Kabel ABS D/E ISO 9141



• Kofer za dijagnostiku sistema na autobusima **W: 446 301 026 0** **R: KOCN1765**

Sadržaj kofera za dijagnostiku sistema na autobusima:

- Diagnostic Interface
- Kabel MB Actros/Citaro
- Kabel EBS Euro Neoplan
- Kabel MAN-TGA
- Kabel Setra NF 315 MTS
- Kabel Actros MPII (OBD II)
- Kabel 15-pol. DAF, Scania, MAN (OBD II)



• Paketi dijagnostičkih programa:

- PAKET FULL (KAMIONI, AUTOBUSI, PRIKOLICE) **W: 246 301 900 0**
R: OPRE0098
- PAKET PRIKOLICA - POLUPRIKOLICA **W: 246 301 901 0**
R: OPRE0524
- PAKET AUTOBUSI **W: 246 301 902 0**
R: OPRE0525
- PAKET KAMIONI **W: 246 301 904 0**
R: OPRE0526



RAPIDEX TRADE svake godine u saradnji sa WABCO-m organizuje **OBUKU - TRENING** za servisere WABCO sistema.

Obuka se odvija u **EDUKATIVNOM CENTRU** u Novom Sadu, Novosadski put 160.

Do sada je obuku uspešno završilo nekoliko generacija polaznika, koje se uspešno nose sa svakodnevnim problemima kvarova na vozilima širom Srbije i zemalja u okruženju.

Predavač WABCO TRENER gospodin Berislav Babić



Detalji sa obuke u edukativnom centru



- **PROIZVODI i REŠENJA** za komercijalna vozila
- **PRIMENA** za proizvodnju vozila
- **ORIGINALNI KVALITET** za Popravku

4.0 KOMPONENTE KOČIONOG SISTEMA

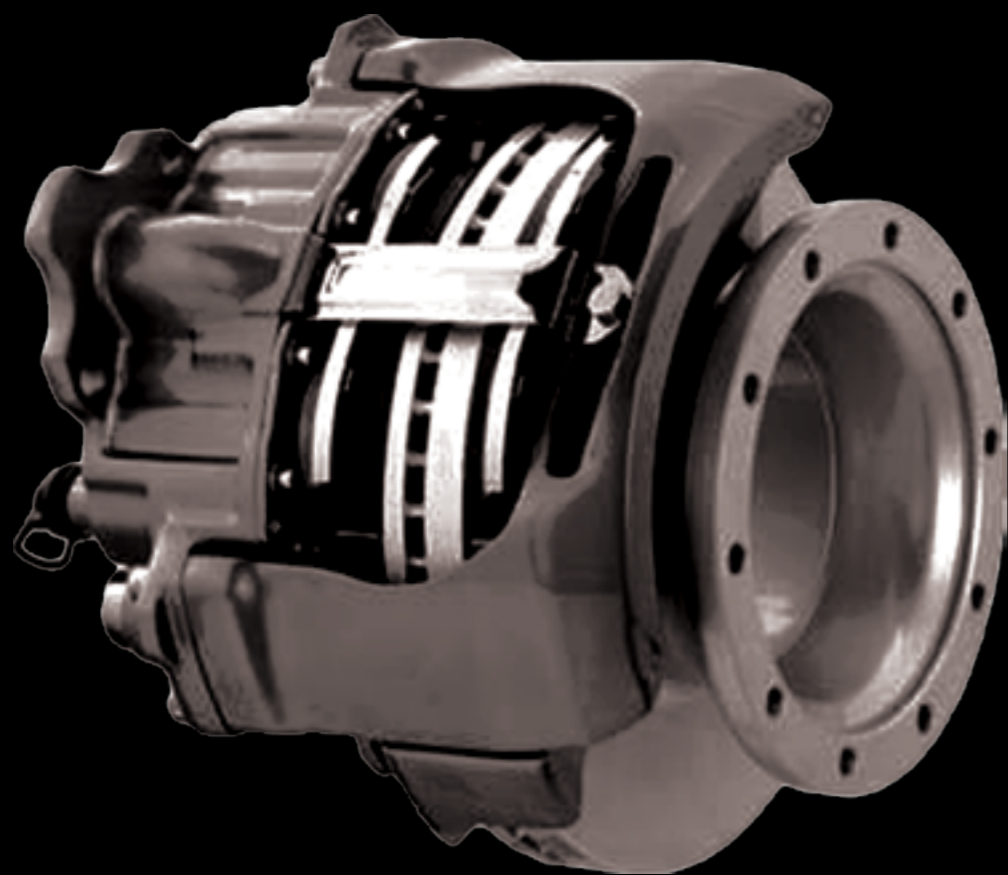



4.0 KOMPONENTE KOČIONOG SISTEMA

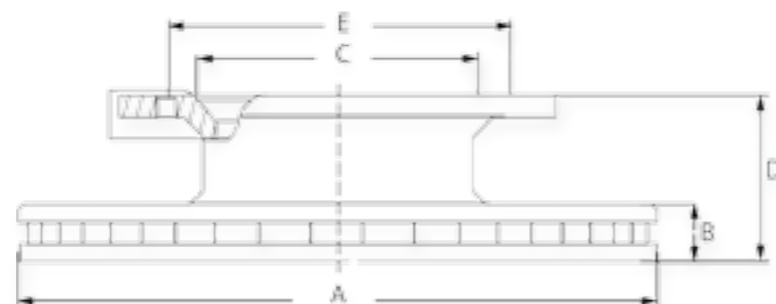



4.1	Disk kočnica	114
4.2	Kočione pločice	117
4.3	Čeljusti kočnica	120
4.4	Doboši kočnica	121
4.5	Kočione obloge	122
4.6	Šteleri kočnica	124
4.7	Glavčine točka, ležajevi i semerinzi	126
4.8	Vijci i navrtke	129

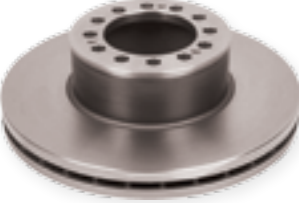



DISK KOČNICA								
	Poz.	Model	OE broj			RAPIDEX broj		
	1.	L2000, Bus SG, SL 150-190, SU 210, 230	81.50803.0010			KOCN0937		
A (mm)	Bmin (mm)	Bmax (mm)	C (mm)	D (mm)	E (mm)	Rupe	Pozicija	
324	26	30	135	102	158	10 x M14 x 1,5 mm	Pr	
	Poz.	Model	OE broj			RAPIDEX broj		
	2.	L2000, M2000, Bus SG, SL 150-190, SU 230	81.50803.0022			KOCN1380		
A (mm)	Bmin (mm)	Bmax (mm)	C (mm)	D (mm)	E (mm)	Rupe	Pozicija	
330	28	34	157	124	180	12 x M12 x 1,5 mm	Pr/Zd	



DISK KOČNICA								
	Poz.	Model	OE broj			RAPIDEX broj		
	3.	L2000, M2000, Bus SG, SL 150-190,	81.50803.0026			KOCN0943		
A (mm)	Bmin (mm)	Bmax (mm)	C (mm)	D (mm)	E (mm)	Rupe	Pozicija	
330	30	34	135	104	158	10 x M14 x 1,5 mm	Pr/Zd	
	Poz.	Model	OE broj			RAPIDEX broj		
	4.	L2000, M2000	81.50803.0039			KOCN1378		
A (mm)	Bmin (mm)	Bmax (mm)	C (mm)	D (mm)	E (mm)	Rupe	Pozicija	
330	30	34	145	130	177	8 x M12 x 1,5 mm	Zd	
	Poz.	Model	OE broj			RAPIDEX broj		
	5.	L2000, LE, TGL, TGM	81.50803.0042			KOCN0603		
A (mm)	Bmin (mm)	Bmax (mm)	C (mm)	D (mm)	E (mm)	Rupe	Pozicija	
335	26	34	90	93	122	10 x Ø15 mm 2 x M10 x 1,5 mm	Pr/Zd	
	Poz.	Model	OE broj			RAPIDEX broj		
	6.	LE, TGL, TGM	81.50803.0063			KOCN0604		
A (mm)	Bmin (mm)	Bmax (mm)	C (mm)	D (mm)	E (mm)	Rupe	Pozicija	
335	26	34	154	118	176	10 x M14 x 1,5 mm 2 x M8 x 1,25 mm	Zd	



DISK KOČNICA									
	Poz.	Model	OE broj			RAPIDEX broj			
	7.	TGA, Bus Lion's city, coach, comfort, NG 262, 263, 312, 313, NU 263, 313	81.50803.0040			KOCN0130			
A (mm)	Bmin (mm)	Bmax (mm)	C (mm)	D (mm)	E (mm)	Rupe		Pozicija	
430	37	45	131	130	168	12 x Ø19 mm 3 x M12 x 1,5 mm		Pr	
	8.	TGA, Bus Lion's city, coach, comfort, NG 262, 263, 312, 313, NU 263, 313	81.50803.0041			KOCN0892			
A (mm)	Bmin (mm)	Bmax (mm)	C (mm)	D (mm)	E (mm)	Rupe		Pozicija	
432	37	45	208	135	235	10 x M16 x 1,5 mm		Zd	
	9.	M2000, F2000, Bus EI 202, 222, 262, Lion's star, NG 262, 272, 312	81.50803.0009			KOCN0963			
A (mm)	Bmin (mm)	Bmax (mm)	C (mm)	D (mm)	E (mm)	Rupe		Pozicija	
438	37	45	200	135	235	10 x M16 x 1,5 mm		Pr	





KOČIONE PLOČICE						
	WVA broj		Dimenzije (mm)			RAPIDEX broj
	29055	Wabco	175,7	82,5	22	KOCN0517
Poz.	Model		OE broj			
1.	L2000, M2000		81.50820.6009			
2.	NEOPLAN		82331100			
	29088	Wabco	175,6	82,5	26	KOCN0909
Poz.	Model		OE broj			
1.	L2000, M2000		81.50820.6020			
	29113	Meritor	249,7	118,2	28,2	KOCN0908
Poz.	Model		OE broj			
1.	F2000, TG		81.50820.6046			
2.	BUS-LIONS, TEMSA		81.50820.6046			



KOČIONE PLOČICE						
	WVA broj		Dimenzije (mm)			RAPIDEX broj
		29131	Meritor	249,5	118,1	30,2
	Poz. Model		OE broj			
	1.	TGA, TGX, TGS	81.50820.6041			

	WVA broj		Dimenzije (mm)			RAPIDEX broj
		29202	Knorr	247,3	109,5	30
	Poz. Model		OE broj			
	1.	TGA, TGS, TGX	81.50820.6030			

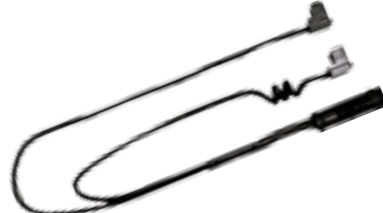
SENZORI ISTROŠENOSTI PLOČICA					
Slika	Poz.	Model	Dimenzije	OE broj	RAPIDEX broj
	1.	L2000, M2000	405 mm	81.50822.6016	KOCN0776
	2.	F2000, TGA	194 mm	81.25937.6011	KOCN3306

SENZORI ISTROŠENOSTI PLOČICA					
Slika	Poz.	Model	Dimenzije	OE broj	RAPIDEX broj
	3.	F2000, TGA	335 mm	81.50811.0004	KOCN0395
	4.	TGA, TGS, LION'S	1750 mm	81.25937.6041	KOCN2780
	5.	TGA, LION'S	370 mm	81.50822.6017	KOCN0228
	6.	TGA, LION'S	405 mm	81.50822.6016	KOCN2213



ČELJUSTI						
Poz.	Model	Tip čeljusti	Proizvođač	KBP	OE broj	RAPIDEX broj
1.	L2000	1000 V-G	WABCO	40 100 001	81.50804.6017	KOCN0988
2.	L2000	1000 V-G	WABCO	40 100 002	81.50804.6018	KOCN0987
3.	L2000 1996 -	PAN 17	WABCO	40 175 049	81.50804.6087	KOCN0887
4.	L2000 1996 -	PAN 17	WABCO	40 175 050	81.50804.6088	KOCN0411
5.	TGL	17,5	KNORR	SN5011	81.50804.6418	KOCN2835
6.	TGL	17,5	KNORR	SN5001	81.50804.6419	KOCN2834
7.	F2000	22,5	MERITOR	LRG570	81.50804.6201	KOCN0580
8.	F2000	22,5	MERITOR	LRG571	81.50804.6202	KOCN0581
9.	F2000	22,5	MERITOR	LRG524	81.50804.6063	KOCN1406
10.	F2000	22,5	MERITOR	LRG525	81.50804.6064	KOCN1766
11.	TGA	22,5	MERITOR	LRG586	81.50804.6285	KOCN0576
12.	TGA	22,5	MERITOR	LRG588	81.50804.6291	KOCN0574
13.	TGA	22,5	MERITOR	LRG589	81.50804.6290	KOCN0573
14.	TGA	22,5	MERITOR	LRG544	81.50804.6311	KOCN0265
15.	TGA	22,5	MERITOR	LRG545	81.50804.6138	KOCN1767
16.	TGA	22,5	MERITOR	LRG638	81.50804.6321	KOCN0294
17.	TGA	22,5	MERITOR	LRG639	81.50804.6322	KOCN0160

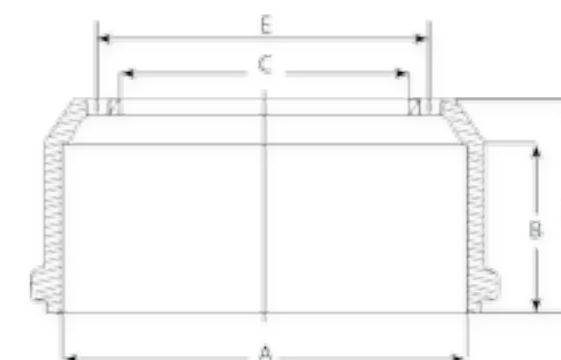

DOBOŠI KOČNICA										
Poz.	Model	A (mm)	B (mm)	C (mm)	D (mm)	E (mm)	Rupe	Pozicija	OE broj	RAPIDEX broj
1.	L2000, M2000, BUS	360	187	230	247	275	8 x Ø22 mm	Zd	81.50110.0237	KOCN0302
2.	L2000, F2000, TGA 00-	410	173	298	250	335	10 x Ø23 mm, 5 x Ø24 mm 3 x M12 x 1,5 mm	Pr	81.50110.0242	KOCN1415
3.	F90 86- F2000, TGA 00-	410	188	298	232	335	10 x Ø23 mm, 5 x Ø24 mm 3 x M12 x 1,5 mm	Pr	81.50110.0232	KOCN0819
4.	F90 86- F2000, TGA, BUS EL202-26, Lion's	410	232	298	300	335	10 x Ø23 mm, 5 x Ø24 mm 3 x M12 x 1,5 mm	Zd	81.50110.0144	KOCN3161
5.	M2000, M90, F90, F2000, BUS svi modeli	410	193	298	280	335	10 x Ø23 mm	Zd	81.50110.0101	KOCN0780
6.	F90 86-	410	187	298	232	335	10 x Ø23 mm, 3 x M12 x 1,5 mm	Pr	81.50110.0232	KOCN0668
7.	BUS EL 202-262	410	166	298	213	335	10 x Ø23 mm, 3 x M12 x 1,5 mm	Pr/Zd	81.50110.0223	KOCN3100



M90, L2000, M2000

	WVA broj	Ø	↕	↔	T	OE broj	RAPIDEX broj
	19494	410	163	178	8	81.50221.6094	
	19494 170008						KOCN0390
	19494 183008						KOCN0391
	19494 191008						KOCN0392
Model							
M90, L2000, M2000							

M90, F90, L2000, M2000, F2000





	WVA broj	Ø	↕	↔	T	OE broj	RAPIDEX broj
	19495	410	183	178	8	81.50221.6098	
	19495 170008						KOCN0356
	19495 183008						KOCN0357
	19495 191008						KOCN0358
Model							
M90, F90, L2000, M2000, F2000							





F90, F2000, TGA

	WVA broj	Ø	↕	↔	T	OE broj	RAPIDEX broj
	19496	410	223	178	8	81.50220.0632	
	19496 170008						KOCN1176
	19496 183008						KOCN0355
	19496 191008						KOCN0224
Model							
F90, F2000, TGA							

NITNE ZA OBLOGE

	Model	Dimenzije	Set	KBP	RAPIDEX broj
	SVI MODELI	Ø8 x 18 mm	100 kom	96000 0045	KOCN0388

ŠTELERI KOČNICA							
Slika	Poz.	Model	Broj zuba	Oso rastojanje (mm)	HalDEX broj	OE broj	RAPIDEX broj
	1.	M2000, F90, F2000	26	145	79203C	81.50610.6183	KOCN0716
	2.	M2000, F90, F2000	26	145	79204C	81.50610.6184	KOCN0715
	3.	M2000, F90, F2000	26	145	79205C	81.50610.6176	KOCN0516
	4.	M2000, F90, F2000	26	145	79206C	81.50610.6177	KOCN3410
	5.	M2000, F90, F2000	26	145	79208C	81.50610.6211	KOCN1470

ŠTELERI KOČNICA							
Slika	Poz.	Model	Broj zuba	Oso rastojanje (mm)	HalDEX broj	OE broj	RAPIDEX broj
	6.	M2000, F90, F2000	26	145	79209C	81.50610.6210	KOCN1471
	7.	TGM, TGA, TGX, TGS	26	145	80179C	81.50610.6260	KOCN0508
	8.	TGM, TGA, TGX, TGS	26	145	80180C	81.50610.6261	KOCN1467
	9.	TGM, TGA, TGX, TGS	26	145	80181C	81.50610.6262	KOCN1468
	10.	TGM, TGA, TGX, TGS	26	145	80183C	81.50610.6266	KOCN0546

GLAVČINE TOČKA

Poz.	Model	OE broj	RAPIDEX broj
1.	F2000	81.53570.1010	OSOV0970
2.	TGA, TGS, TGX	81.35701.0155	OSOV0971
3.	TGL, TGM	81.35701.0165	KOCN0051
4.	TGL, TGM KOMPLET	81.93420.0337	KOCN0319

LEŽAJEVI

Poz.	Model	Dimenzije (mm)			KBP	OE broj	RAPIDEX broj
1.	L2000, M2000	72	35	24,23	32207A VKHB2018	06.32499.0079	OSOV0109
2.	L2000, F2000, F90	110	50	42,25	32310 VKHB2070	06.32499.0016	OSOV0219
3.	L2000, F2000, F90	170	110	47	33022 VKHB2163	06.32499.0155	OSOV0423
4.	L2000, F2000	145	95	39	33019 VKHB2082	06.32429.0036	OSOV0717
5.	L2000, M2000, F2000	100	55	40	201009 VKHB2240	06.32489.0072	OSOV0098
6.	L2000, F90, F2000	125	75	37	33115	06.32499.0040	OSOV0033
7.	TGL, TGM	130	78	90	803194 VKBA5415	81.93420.6083	OSOV0072
8.	TGL, TGM	140	82	115	VKBA5412	81.93420.0344	OSOV0095
9.	TGM	168	60	102	201081 VKBA5414	81.93420.0353	OSOV0540
10.	M2000, F2000	160	106	35	VKBA2172	06.32489.0009	OSOV0424
11.	M2000, F90, F2000	160	105	43	33021 VKHB2162	06.32499.0080	OSOV0415
12.	M2000, F2000	100	45	38,25	32309 VKHB2004	06.32499.0013	OSOV0416
13.	F2000, BUS NG, NL 202-263	130	70	57	VKBA5162	06.32499.0043	OSOV0768
14.	F2000, TGA, TGS, TGX, BUS LION-S	196	70	130	VKHB5377	81.93420.0288	OSOV0093
15.	TGA, TGS, TGX, BUS LION-S	160	105	140	803750B VKBA5408	81.93420.0342	OSOV0091



SEMERINZI

Poz.	Model	Dimenzije (mm)			OE broj	RAPIDEX broj
1.	L2000, M2000	87,26	120,76	15,4	81.96503.0161	OSOV0713
2.	L2000, M2000	81	100/137	10	81.52403.6001	OSOV0863
3.	L2000, M2000	130	160	16	06.56289.0385	OSTA0113
4.	M2000, L2000	135	175	18	81.96503.0298	OSOV0865
5.	M2000	95	116,5	11	06.56289.0433	OSTA0846
6.	L2000, M2000	80	135/154	13,5/8	06.56289.0293	OSOV0703
7.	L2000, F90, TGA	145	175/205	9/14	06.56289.0371	OSOV0672
8.	M2000, F90, F2000	135	175/205	18	81.96503.0398	OSOV0716
9.	M2000, F90, F2000	85	150/169	12	06.56289.0266	OSOV0715
10.	F90, M2000, F2000	145	175	17	06.56289.0386	OSTA0296
11.	F2000, TGA	135	175	15,5/20	06.56289.0268	OSOV0589
12.	F2000, TGA, TGS, TGX	139	175/205	16,3	51.96503.6000	OSTA1090
13.	TGA, TGX, TGS, BUS LIONS	132	160	10	06.56289.0387	OSOV0610
14.	TGA, TGM, TGX, TGS, L2000	132	172	12	81.96503.0333	OSOV0611

VIJCI I NAVRTKE

Poz.	Model	Naziv	Dimenzije (mm)			Navoj (mm)	OE broj	RAPIDEX broj
1.	F90, F2000	VIJAK	108,5	98	38	M22 x 1,5	81.45501.0080	OSOV0345
		NAVRTKA				M22 x 1,5	81.45503.0026	OSOV0225
2.	F90, M2000, F2000	VIJAK	115,5	105	39	M22 x 1,5	81.45501.0081	OSOV0346
		NAVRTKA				M22 x 1,5	81.45503.0026	OSOV0225
3.	F90, M90, F2000	VIJAK	87,5	77	38	M22 x 1,5	81.45501.0058	OSTA0251
		NAVRTKA				M22 x 1,5	81.45503.0026	OSOV0225
4.	F90, M90, F2000	VIJAK	101,5	91	39	M22 x 1,5	81.45501.0164	OSOV0819
		NAVRTKA				M22 x 1,5	81.45503.0026	OSOV0225
5.	F90, M90, F2000	VIJAK	91	80,5	39	M22 x 1,5	81.45501.0077	OSOV0844
		NAVRTKA				M22 x 1,5	81.45503.0026	OSOV0225
6.	F90, F2000	VIJAK	120,5	110	38	M22 x 1,5	81.45501.0082	OSOV0829
		NAVRTKA				M22 x 1,5	81.45503.0026	OSOV0225
7.	TGA, TGS, TGX	VIJAK	120,5	110	38	M22 x 1,5	81.45501.0082	OSOV0829
		NAVRTKA				M22 x 1,5	81.45503.0026	OSOV0225
8.	F90, F2000	VIJAK	108,5	98	38	M22 x 1,5	81.45501.0059	OSOV0345
		NAVRTKA				M22 x 1,5	81.45503.0026	OSOV0225

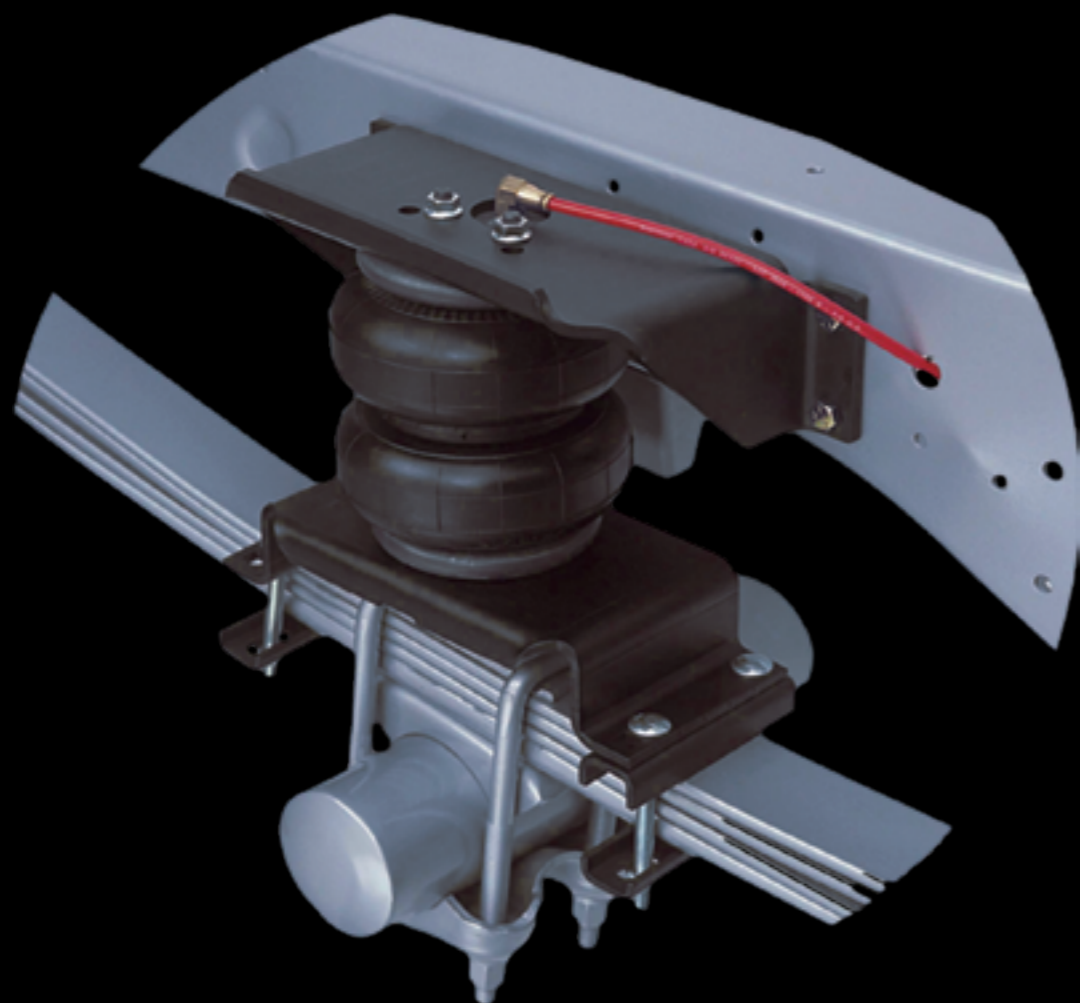
5.0 ELEMENTI OGIBLJENJA I UPRAVLJANJA



5.0 ELEMENTI OGIBLJENJA I UPRAVLJANJA

5.1 Amortizeri	132
5.2 Vazdušni jastuci	136
5.3 Gibnjevi	140
5.4 Delovi stabilizatora	145
5.5 Delovi rukavca	149
5.6 Spone i delovi spona	151
5.7 Uporne spone	156
5.8 V spone	157

AMORTIZERI - TIPOVI VEZA

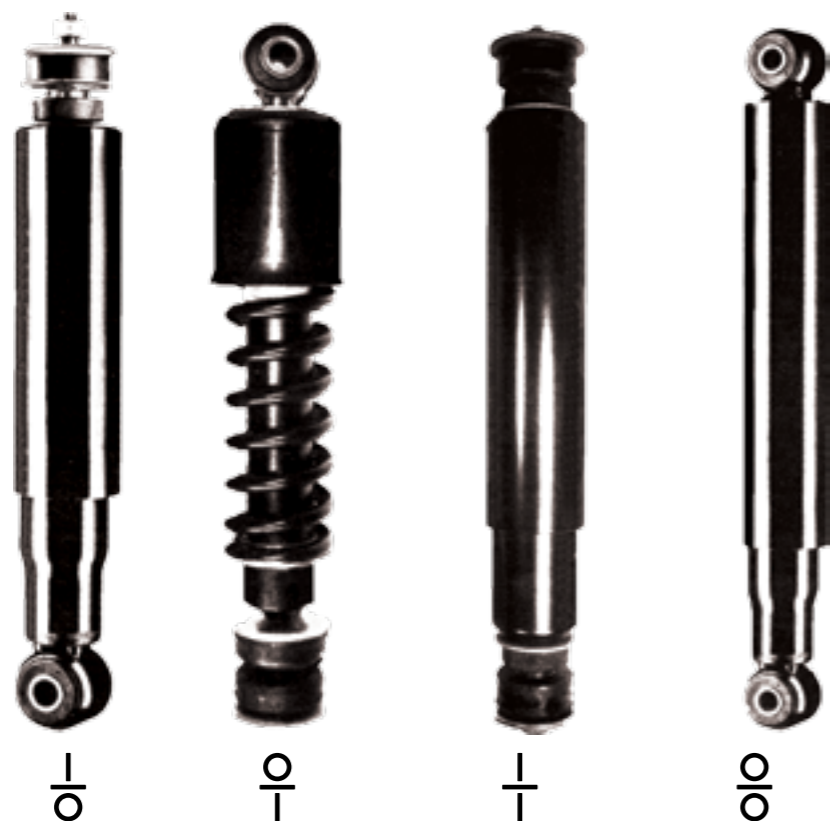

LEGENDA:

SIMBOL	ZNAČENJE	SIMBOL	ZNAČENJE
	VEZA OKO - OKO		AMORTIZER PREDNJE OSOVINE
	VEZA OKO - VIJAK		AMORTIZER ZADNJE OSOVINE
	VEZA VIJAK - OKO		PREDNJA I ZADNJA OSOVINA
	VEZA VIJAK - VIJAK		AMORTIZER KABINE - PREDNJI
	VEZA OKO - VILJUŠKA		AMORTIZER KABINE - ZADNJI
	AMORTIZER VOLANA		AMORTIZER KABINE



AMORTIZERI

Poz.	Model	Osovina	Tip veze	OE broj	Sachs broj	RAPIDEX broj
1.	F90, F2000, M90, M2000L			81.43701.6598	112 859	AMOR0105
2.	F2000, M2000L, M2000M			81.43701.6793	125 148	AMOR0106
3.	F90, F2000, M2000L			81.43701.6711	125 149	AMOR0094
4.	L2000			81.43701.6782	124 610	VESA0088
5.	G90, 9...			81.43701.6349	101 993	AMOR0211
6.	TGA			81.43701.6902	131 750 280 930	AMOR0104
7.	TGA			81.43701.6904	280 928	AMOR0313
8.	TGA			81.43701.6964	280 930	AMOR0104
9.	TGA			81.43701.6905	131 696	AMOR0192
10.	TGA			81.43702.6011	311 480	AMOR0207
11.	TGL			85.43701.6006	311 891	AMOR0099
12.	TGL			81.43702.6000	311 895	AMOR0098
13.	TGA, TGS, TGX			81.43702.6058	314 336	AMOR0490
14.	TGA, TGS, TGX			81.43701.6950	310 629	AMOR0512
15.	TGA			81.43701.6989	311 484	AMOR0380
16.	BUS, TEMSA			81.43701.6672	112 913	AMOR0457
17.	BUS			81.43701.6767	131 061	AMOR0486
18.	BUS EL202, 222, 262, NG, NL, NU			81.43701.6713	112 912	AMOR0069
19.	BUS EL202, 222, 262, NG, NL, NU			81.43701.6672	112 913	AMOR0056

AMORTIZERI - KABINE

Poz.	Model	Mesto ugradnje	Tip veze	Sachs broj	OE broj	RAPIDEX broj
1.	F90, F2000			112 211	81.41722.6014	AMOR0177
2.	F90, F90 Unterflur, F2000			112 855	81.41722.6009	AMOR0118
3.	F90, F90 Unterflur, F2000			112 856	81.41722.6010	AMOR0215
4.	F2000 94/01→			105 855	81.41722.6051	AMOR0229
5.	F2000 94/01→, TGA 28.310-530 00/03→			105 856	81.41722.6052	AMOR0084
6.	F2000			105 843	81.41722.6047	AMOR0514
7.	TGA 18.280-510, 26.310-530, 33.350-530 00/03→			290 977	85.41722.6010	AMOR0001
8.	TGA 18.280-510, 26.310-530, 33.350-530, 41.480-660 00/03→			313 181	85.41722.6014	AMOR0131
9.	TGA 18.280-510, 26.310-530, 33.350-480 00/03→			313 182	85.41722.6015	AMOR0127
10.	TGA 18.280-510, 26.310-530, 33.350-530 00/03→			290 976	85.41722.6019	AMOR0194
11.	TGA 18.280-510, 26.310-530, 33.350-530, 41.480-660 00/03→			313 183	85.41722.6012	AMOR0126
12.	TGA 18.280-510, 26.310-530, 33.350-530 00/03→, TGL 7.150-12.240 05/04→			313 184	85.41722.6013	AMOR0374
13.	TGA 18.280-510, 26.310-530, 33.350-530, 41.480-660 00/03→			300 013	81.41722.6053	AMOR0055
14.	TGA 18.280-510, 26.310-530, 33.350-530, 41.480-660 00/03→			300 015	81.41722.6055	AMOR0395
15.	TGA 18.280-510, 26.310-530, 33.350-530, 41.480-660 00/03→			313 080	81.41722.6056	AMOR0050
16.	TGA 18.280-510, 26.310-530, 33.350-530, 41.480-660 00/03→			300 014	81.41722.6054	AMOR0381

GASNI AMORTIZERI

Poz.	Model	Dužina L (mm)	Sila F (N)	SE-M broj	OE broj	RAPIDEX broj
1.	F2000	720	220	8376	81.74821.0095	AMOR0140
2.	TGA, TGX - XXL	685	220	8375	81.61140.0016	AMOR0139
3.	TGA 460A - XXL	480	50	8378	81.74821.0149	AMOR0141
4.	TGA 460A - XXL	480	350	8379	81.74821.0039	AMOR0142



882N				
	Broj proizvođača dela	OE broj	Primena / Opis	RAPIDEX broj
	Contitech 882N	81.43601.0065	F2000, F90	VESA1617
	Fabio 34882			

884N				
	Broj proizvođača dela	OE broj	Primena / Opis	RAPIDEX broj
	Contitech 884N	81.43601.0068	F2000, F90	VESA1618
	Fabio 34884			

916N1				
	Broj proizvođača dela	OE broj	Primena / Opis	RAPIDEX broj
	Contitech 916N	81.43601.0095	F2000, F90, M2000, TGA	VESA1969
	Fabio 34916			

1885N1				
	Broj proizvođača dela	OE broj	Primena / Opis	RAPIDEX broj
	Contitech 1885N1	81.43601.0104	F2000, F90, M2000 prednja i zadnja osovina (zamenjuje 1884N1)	VESA1619
	Fabio 341885			

1888N				
	Broj proizvođača dela	OE broj	Primena / Opis	RAPIDEX broj
	Contitech 1888N	81.43601.0163	TGA, TGS, TGX (prednja osovina)	VESA1827
	Fabio 341888			

4882N1P01				
	Broj proizvođača dela	OE broj	Primena / Opis	RAPIDEX broj
	Contitech 4882N1P01	81.43601.0151	TGA	VESA1628
	Fabio 344882-S			

4882N1P05				
	Broj proizvođača dela	OE broj	Primena / Opis	RAPIDEX broj
		Contitech 4882N1P05 Fabio 344882-5C	81.43601.6041	TGA (zadnja osovina)

4884N1P01				
	Broj proizvođača dela	OE broj	Primena / Opis	RAPIDEX broj
		Contitech 4884N1P01 Fabio 344884-1S	81.43601.0152	TGA (zadnja osovina)

4884N1P06				
	Broj proizvođača dela	OE broj	Primena / Opis	RAPIDEX broj
		Contitech 4884N1P06 Fabio 344884-6C	81.43600.6035	TGA, TGX, TGS

4885N1P02				
	Broj proizvođača dela	OE broj	Primena / Opis	RAPIDEX broj
		Contitech 4885N1P02 Fabio 344885-C	81.43600.6044	TGA, TGX, TGS

SZ 51-5				
	Broj proizvođača dela	OE broj	Primena / Opis	RAPIDEX broj
		Contitech SZ 51-5	-	Vazdušni jastuk sedišta C.O.B.O.

SA 51-10				
	Broj proizvođača dela	OE broj	Primena / Opis	RAPIDEX broj
		Contitech SA 51-10	-	Vazdušni jastuk sedišta Möve

F2000 (prednja osovina)							
Poz.	Model	Opterećenje (t)	Širina (mm)	Broj listova x debljina lista (mm)	Dužina Lx/Ly (mm)	OE broj	RAPIDEX broj
1.	F2000	7,1	90	3 x 23 1 x 18	900/900	81.43402.6058	VESA0260

F2000 (prednja osovina)							
Poz.	Model	Opterećenje (t)	Širina (mm)	Broj listova x debljina lista (mm)	Dužina Lx/Ly (mm)	OE broj	RAPIDEX broj
2.	F2000	8,0	90	1 x 24 2 x 25 1 x 18 1 x 20	900/690	81.43402.6103	VESA0331



TGA, TGS (prednja osovina)							
Poz.	Model	Opterećenje (t)	Širina (mm)	Broj listova x debljina lista (mm)	Dužina Lx/Ly (mm)	OE broj	RAPIDEX broj
3.	32.310-35.480 02/04→	7,5	90	2 x 30	925/735	81.43402.6265	VESA0336
4.	TGA, TGS, TGX	7,5	90	2 x 30	925/925	81.43402.6301	VESA2042
5.	TGA, TGS, TGX	7,5	90	1 x -	925/925	81.43402.6325	VESA2044
6.	TGA, TGS, TGX	8,0	90	2 x 30	925/925	81.43402.6334	VESA2043
7.	18.410-18.510 26.310-26.530 33.360-40.480 02/04→	8,0	90	3 x 26	925/925	81.43402.6185	VESA0263

TGA, TGS (prednja osovina)							
Poz.	Model	Opterećenje (t)	Širina (mm)	Broj listova x debljina lista (mm)	Dužina Lx/Ly (mm)	OE broj	RAPIDEX broj
8.	32.310-35.480 01/02→ 35.530-41.530 07/06→ 41.350-41.530 12/04→	8,0	90	3 x 25	925/735	81.43402.6293	VESA0259
9.	32.310-35.530 09/02→ 41.410-41.530	8,0	90	1 x 24 3 x 23	925/735	81.43402.6200	VESA0337
10.	32.310-35.530 09/02→ 41.410-41.530	9,5	90	4 x 25	925/735	81.43402.6309	VESA0261



TGA, TGS (zadnja osovina)							
Poz.	Model	Opterećenje (t)	Širina (mm)	Broj listova x debljina lista (mm)	Dužina Lx/Ly (mm)	OE broj	RAPIDEX broj
11.	26.310-26.480, 32.310-35.480 40.410-40.480 05/04→	13,0	100	3 x 31 2 x 35	825/825	81.43402.6605	VESA0258
12.	F90 01/88-05/95, 18.360→, 26.310-26.530 10/00→, 33.410-33.530, 40.410-40.480 04/04→	16,0	100	3 x 31 2 x 42	825/825	81.43402.6681	VESA0338

TGA, TGS (zadnja osovina)							
Poz.	Model	Opterećenje (t)	Širina (mm)	Broj listova x debljina lista (mm)	Dužina Lx/Ly (mm)	OE broj	RAPIDEX broj
13.	26.310-26.480, 32.310-35.480 40.410-40.480 05/04→	16,0	100	16 x 18	825/825	81.43402.6648	VESA0262

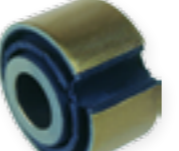

ČAURE						
Slika	Poz.	Model	Dimenzije d x D x h (mm)	SE-M broj	OE broj	RAPIDEX broj
	1.	F2000	24 x 70 x 95	1015	81.43722.0061	VESA1028
	2.	M2000L, M2000M 08/95-12/05	20 x 57 x 84	7856	81.43722.0051	VESA0243
	3.	TGA, TGS 32.310-35.480 01/02→, 35.530-41.530 07/06→, 41.350-41.530 12/04→	24 x 65 x 95	7920	81.43722.0070	VESA0636
	4.	TGA, TGS, TGX	24 x 62 x 95	9236	81.43722.0091	VESA2057
	5.	TGA, TGS, TGX	15 x 100 x 120 x 85	9043	81.96210.0552	VESA1246
	6.	F2000	-	7934	81.96210.5022	VESA0250
	7.	TGA, TGX, TGM	-	8448	81.96210.0554	VESA1658
	8.	TGA, TGX, TGM	-	8449	81.96210.0555	VESA1659

DELOVI STABILIZATORA							
Slika	Pozicija	Model	Mesto ugradnje	Dimenzije d x D x h (mm)	SE-M broj	OE broj	RAPIDEX broj
	1.	G90 09/87-10/93	ZO	14 x 37.5 x 51	7704	81.96020.0286	VESA0469
	2.	L2000 09/00→	PO	39 x 56 x 60	7723	81.43722.0053	VESA0468
	3.	F90, G90 09/87-10/93, F2000 01/94→	PO	16 x 45 x 47	7529	81.43722.0022	VESA0812
	4.	F90 04/89-06/96	ZO	22 x 75 x 62	7527	81.43722.0019	VESA0565
	5.	F90 04/89-12/90, M90 05/90-06/96	ZO	22 x 65 x 62	7528	81.43722.0021	VESA0813
	6.	F2000 01/94-12/95, M2000 08/95-12/05	ZO	22 x 67 x 62	7622	81.43722.0039	VESA0807
	7.	F90 02/90-06/96	PO	24 x 64 x 44	7673	81.43722.0047	VESA0804

DELOVI STABILIZATORA							
Slika	Pozicija	Model	Mesto ugradnje	Dimenzije d x D x h (mm)	SE-M broj	OE broj	RAPIDEX broj
	8.	F2000 01/94-12/95, M2000 08/95-12/05	ZO	22 x 68 x 62	7689	81.43722.0063	VESA0591
	9.	F90, G90 09/87-10/93, F2000 01/94→	PO	16 x 47 x 47	7545	81.96210.0450	VESA0809
	10.	TGA, TGX, TGS	PO	16 x 50 x 47	7702	81.43722.0059	VESA0121
	11.	TGA, TGX, TGS	PO	18 x 47 x 47	10425	81.96210.0618	VESA2058
	12.	F90 04/89-06/96	PO	44 x 47 x 60	7502	81.43704.0067	VESA0818
	13.	F90 02/90-06/96, F2000 01/94-12/98	ZO	60 x 78 x 60	7503	81.43704.0061	VESA0817
	14.	F90 04/90-06/96	ZO	56 x 93 x 70	7504	81.43271.0081	VESA0816

DELOVI STABILIZATORA							
Slika	Pozicija	Model	Mesto ugradnje	Dimenzije d x D x h (mm)	SE-M broj	OE broj	RAPIDEX broj
	15.	F90 04/89-06/96	ZO	55 x 77 x 60	7532	81.43704.0060	VESA0598
	16.	M2000	PO	45 x 64 x 51	7808	81.43704.0074	VESA0590
	17.	TGA, TGS	PO	43 x 76 x 50	8015	81.43704.0079	VESA0630
	18.	TGA, TGS	PO	46 x 76 x 50	7953	81.43704.0078	VESA0633
	19.	TGA, TGS	ZO	52 x 76 x 50	7865	81.43704.0077	VESA0799
	20.	F2000, M2000, TGA, TGS	ZO	55 x 82 x 70	7620	81.43722.0040	VESA0808
	21.	G90, L2000, M2000, M90	PO	46 x 71 x 80	7574	81.43704.0029	VESA0597

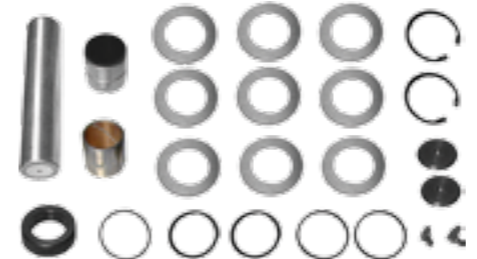
DELOVI STABILIZATORA							
Slika	Pozicija	Model	Mesto ugradnje	Dimenzije d x D x h (mm)	SE-M broj	OE broj	RAPIDEX broj
	22.	F90 02/90-06/96	ZO	39 x 66 x 75	7575	81.43704.0026	VESA0596
	23.	F90 02/90-06/96	ZO	60 x 85 x 80	8032	81.43704.0032	VESA0595
	24.	M90 08/88-06/96	ZO	19 x 65 x 130	7526	81.43271.0087	VESA0599
	25.	S2000	-	15 x 67 x 80	7709	81.43220.6177	VESA0124
	26.	S2000	-	- x 67 x 83	7708	81.43220.6177	VESA0123

DELOVI RUKAVACA				
Slika	Poz.	Model	OE broj	RAPIDEX broj
	1.	F7/8/9, SL, SG	81.44205.6010	OSOV0229
	2.	F90, M90, F2000, M2000, L2000	81.44205.6013	OSOV0230
	3.	M90, M2000, NG, LION'S	81.44205.6018	OSOV0191
	4.	F90	81.36305.0015S	VESA0583
	5.	M2000, F2000	81.44205.6023	OSOV0136

DELOVI RUKAVACA				
Slika	Poz.	Model	OE broj	RAPIDEX broj
	6.	L2000	81.44205.6020	OSOV0143
	7.	L2000	81.44205.6024	OSOV0139
	8.	L2000, TGL, TGM	81.44205.6033	OSOV0917
	9.	F2000, TGA, TGS, TGX	81.44205.6030	OSOV0738

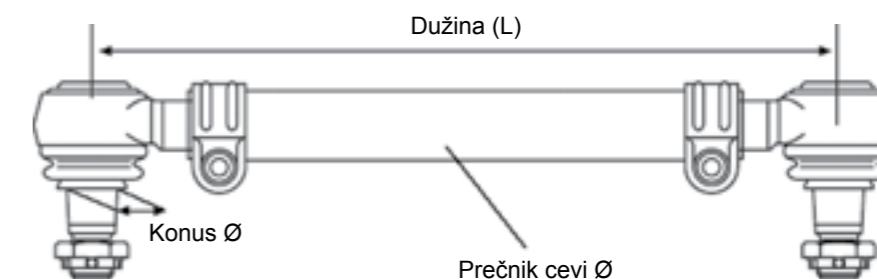

SPONE				
Poz.	Model	Opis	OE broj	RAPIDEX broj
1.	L2000, M2000	Dužina: 840 (mm) Ø Cevi: 38 (mm) Ø Konusa: 22 (mm)	85.46610.6140	VESA2016
			85.46610.6121	
			85.46610.6021	
2.	L2000, 1994→	Dužina: 826 (mm) Ø Cevi: 32 (mm) Ø Konusa: 20 (mm)	85.46610.6201	VESA0045
			85.46610.6030	
			81.46610.6725	
			85.46610.6102	
3.	F90 1988-1995, F2000 1994-1995	Dužina: 1040 (mm) Ø Cevi: 46 (mm) Ø Konusa: 30 (mm)	81.46610.6723	VESA2017
			81.46610.6333	
			81.46610.6355	
			81.46610.6360	
			81.46610.6721	
			81.46610.6354	

SPONE				
Poz.	Model	Opis	OE broj	RAPIDEX broj
4.	F2000 1994-1995	Dužina: 1060 (mm) Ø Cevi: 48 (mm) Ø Konusa: 30 (mm)	81.46610.6782 81.46610.6779 81.46610.6780	VESA0109
5.	F90 1988-1995, F2000 1994-1995	Dužina: 1070 (mm) Ø Cevi: 48 (mm) Ø Konusa: 30 (mm)	81.46610.6656 81.46610.6659	VESA0479
6.	TGA 2000→	Dužina: 967 (mm) Ø Cevi: 52 (mm) Ø Konusa: 30 (mm)	81.46611.6137 81.46611.6134 81.46611.6105 81.46611.6135	VESA2097
7.	TGA 2000→	Dužina: 993 (mm) Ø Cevi: 52 (mm) Ø Konusa: 30 (mm)	81.46611.6133	VESA2018
8.	F90 1988-1995, F2000 1994-1995, L2000 1994→, M2000 1995→, TGA 2002→, TGM 2005→	Dužina: 1588 (mm) Ø Cevi: 52 (mm) Ø Konusa: 30 (mm)	81.46710.6122 81.46711.6736 81.46710.6380 81.46710.6836 81.46710.6378 81.46710.6830	VESA0594

SPONE				
Poz.	Model	Opis	OE broj	RAPIDEX broj
9.	F90 1988-1995, F2000 1994-1995, M90 1990-1996, M2000 1995-2000, TGA 2002→	Dužina: 1652 (mm) Ø Cevi: 50 (mm) Ø Konusa: 30 (mm)	81.46710.6353 81.76710.6879 81.46710.6354 81.46711.6725 81.46710.6198 81.46710.6163	VESA2019
10.	F2000 1994-1995	Dužina: 1655 (mm) Ø Cevi: 50 (mm) Ø Konusa: 30 (mm)	81.46711.6726 81.46711.6729 81.46710.6994	VESA0928
11.	TGA 2000→, TGM 2005→	Dužina: 1729 (mm) Ø Cevi: 52 (mm) Ø Konusa: 30 (mm)	81.46711.6863 81.46711.6860 81.46711.6861	VESA2020

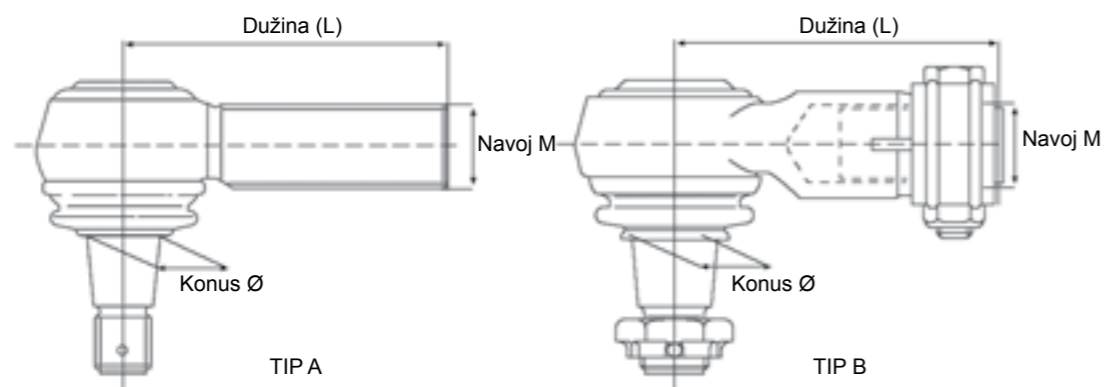

DELOVI SPONA							
Poz.	Model	Dužina L (mm)	Konus Ø (mm)	Navoj M (mm)	Tip A/B	OE broj	RAPIDEX broj
1.	F2000, F90, L2000, M2000, TGA	55	-	M12 x 1.75 ♂	B	81.95301.6063	VESA0842
2.	F2000, F90, L2000, M2000, TGA	55	-	M12 x 1.75 ♀	B	81.95301.6064	VESA0843
3.	F2000, F90	80	30	M26 x 1.5 ♂	B	81.95301.6219	VESA0844
4.	L2000, TGA	95	20	M24 x 1.5 ♂	A	81.95301.6134	VESA0182
5.	L2000, TGA	95	20	M24 x 1.5 ♀	A	81.95301.6141	VESA0183

DELOVI SPONA							
Poz.	Model	Dužina L (mm)	Konus Ø (mm)	Navoj M (mm)	Tip A/B	OE broj	RAPIDEX broj
6.	G90, L2000, TGL, TGM	105	22	M28 x 1.5 ♂	A	81.95301.6135	VESA0096
7.	M90, M2000, TGL	115	26	M30 x 1.5 ♂	A	81.95301.6163	VESA2145
8.	M90, M2000, TGL	115	26	M30 x 1.5 ♀	A	81.95301.6162	VESA2144
9.	F90, F2000, TGA	120	30	M30 x 1.5 ♂	A	81.95301.6030	VESA2023
10.	F90, F2000, TGA	120	30	M30 x 1.5 ♀	A	81.95301.6143	VESA2022



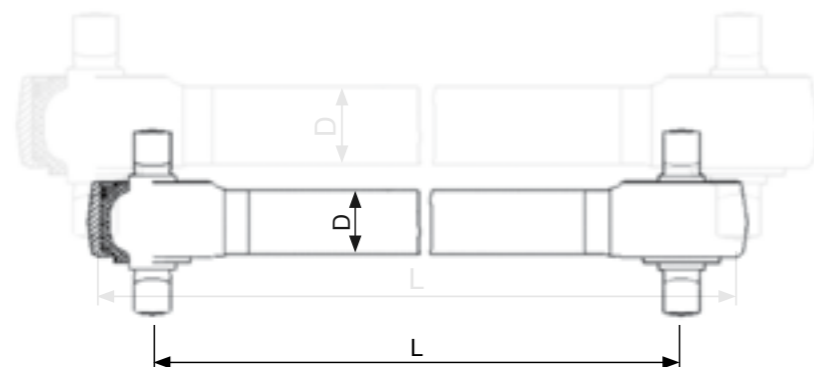

UPORNE SPONE

Poz.	Model	L (mm)	D (mm)	Reparatur set	Lemförder broj	OE broj	RAPIDEX broj
1.	F90, F2000 01/94→	590	48	81.95302.0059	18495 01	81.43220.6090	VESA0582
2.	F90, F2000, M2000, M90, TGA 26310-26530 12/00→	571	48	85.43220.6002	11757 02	81.43220.6129	VESA2021
3.	TGA 18310-18533 04/00→, TGA 24350-28530 09/02→, TGA 32310-35530 09/02→, TGA 41360-41660 09/02→	566	50	85.43220.6002	-	81.43220.6236	VESA2039
4.	TGA 18310-18533 04/00→, TGA 26310-26530 09/02→	572	52	85.43220.6002	28329 01	81.43220.6268	VESA0452
5.	TGA 18310-18533 04/00→, TGA 26310-26530 09/02→	941	60	81.43220.6244	25207 01	81.43220.6260	VESA0593
6.	M90	755	50	81.43220.6132	21418 01	81.43230.6038	VESA0991
7.	TGA, TGS, TGX	414	50	-	27846 01	81.43220.6247	VESA1388



V SPONE

Poz.	Model	L (mm)	D (mm)	Reparatur set	Lemförder broj	OE broj	RAPIDEX broj
1.	F90, F2000	621	50	81.43270.6080 (1x)	11760 02	81.43270.6034	VESA0613
2.	TGA 18310-530, TGA 26310-530, TGA 32310-35530 10/03→	627	48	81.43270.6080 (1x) 81.43270.6105 (2x)	25210 01	81.43270.6096	VESA1534
3.	TGA 18360, 26310-530, 33360-530	627	58	81.95301.6132 (1x)	30416 01	81.43270.6117	VESA0252
4.	F2000 08/95→, TGA 18310-530, 26310-530, 32310-480, 33360-530	627	48	81.43270.6105 (2x)	26053 01	81.43270.6087	VESA0251
5.	TGA, TGS, TGX	627	48	-	25211 01	81.43270.6097	VESA1988
6.	F2000, TGA, TGS, TGX	627	48	81.43270.6105 (2x)	27709 01	81.43270.6116	VESA1318

6.0 KABINA I DELOVI KABINE



6.0 KABINA I DELOVI KABINE

6.1	Delovi kabine	160
6.2	Ogledala i delovi ogledala	184
6.3	Cilindri i pumpe za dizanje kabine	188
6.4	Elementi za oslanjanje kabine	190
6.5	Uređaji za pranje vetrobranskog stakla	195
6.6	Mehanizam vrata	196

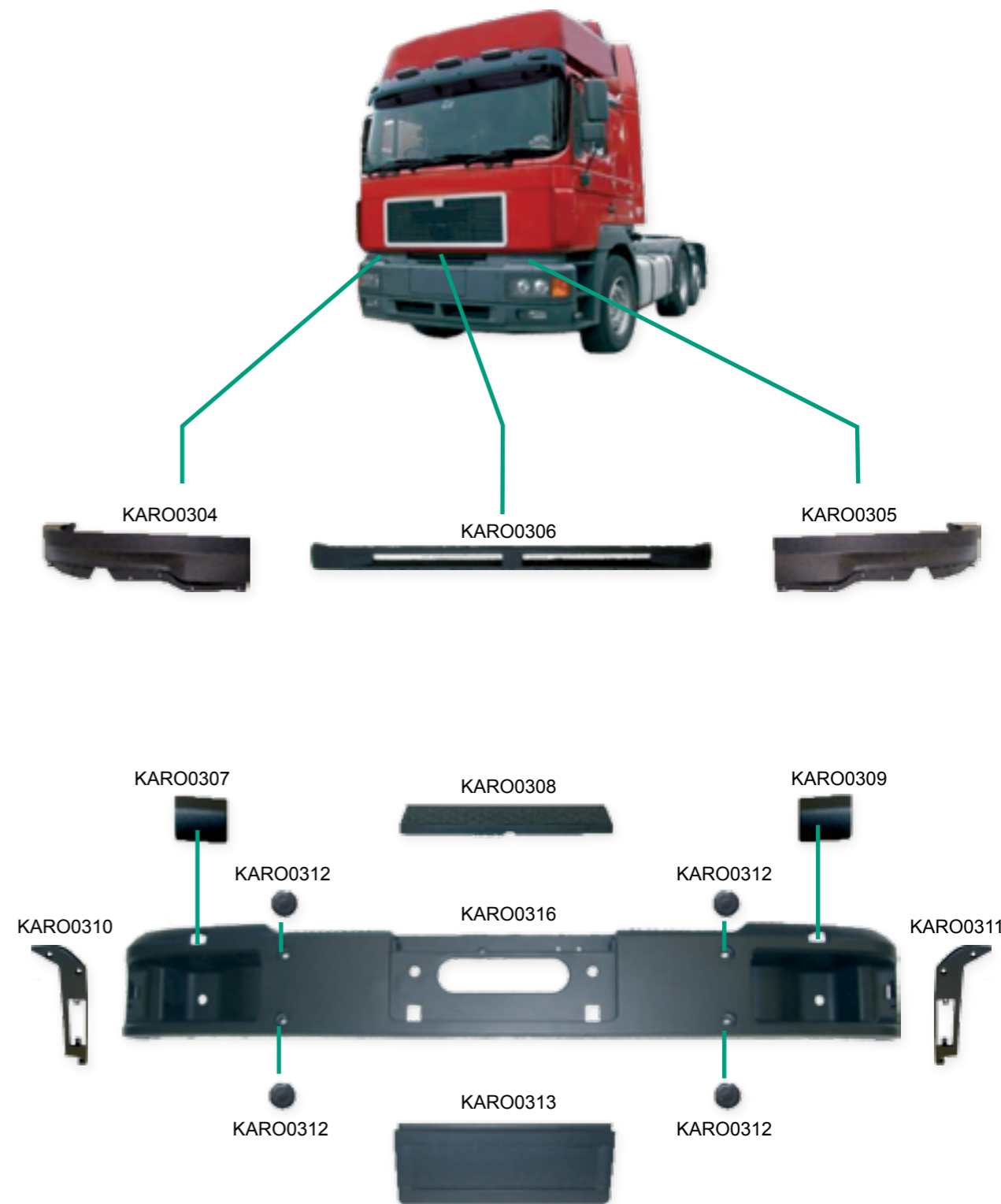
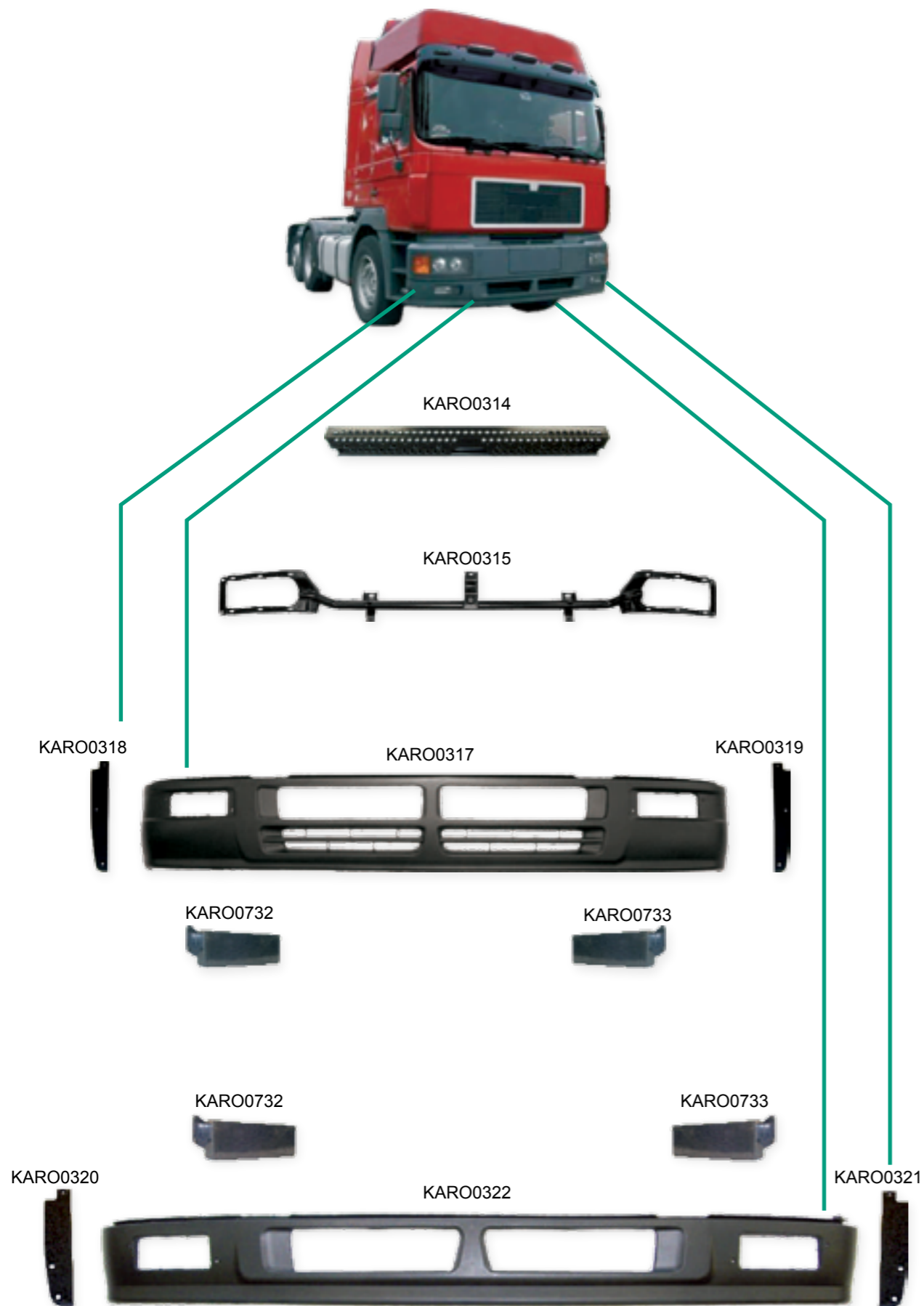



KARO0346



KARO0347



KARO0348



KARO0349



KARO0350



KARO0734



KARO0351



KARO0735

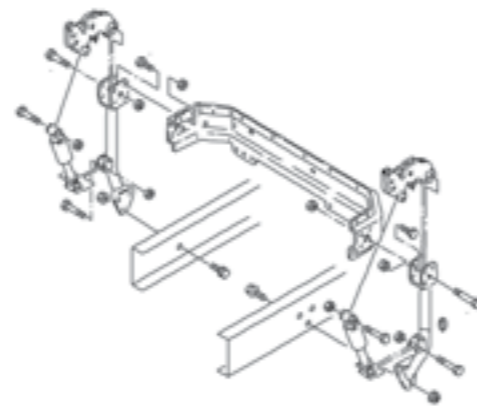
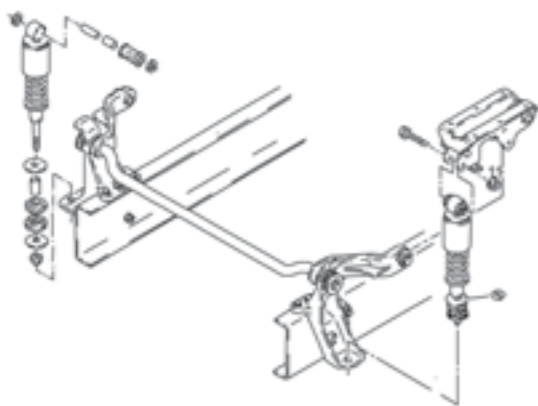

KARO0325



KARO0326



KARO0327



KARO0328



KARO0333



KARO0334



KARO0331



KARO0332



KARO0323



KARO0324



KARO0329



KARO0335



KARO0336



KARO0330



KARO0344



KARO0345



KARO0337



KARO0341



KARO0342



KARO0338



KARO0339



KARO0343

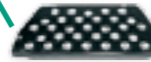

KARO0340





KARO0366



KARO0367



KARO0362

KARO0364

KARO0363

KARO0365



KARO0368

KARO0369

KARO0370



KARO0736



KARO0352

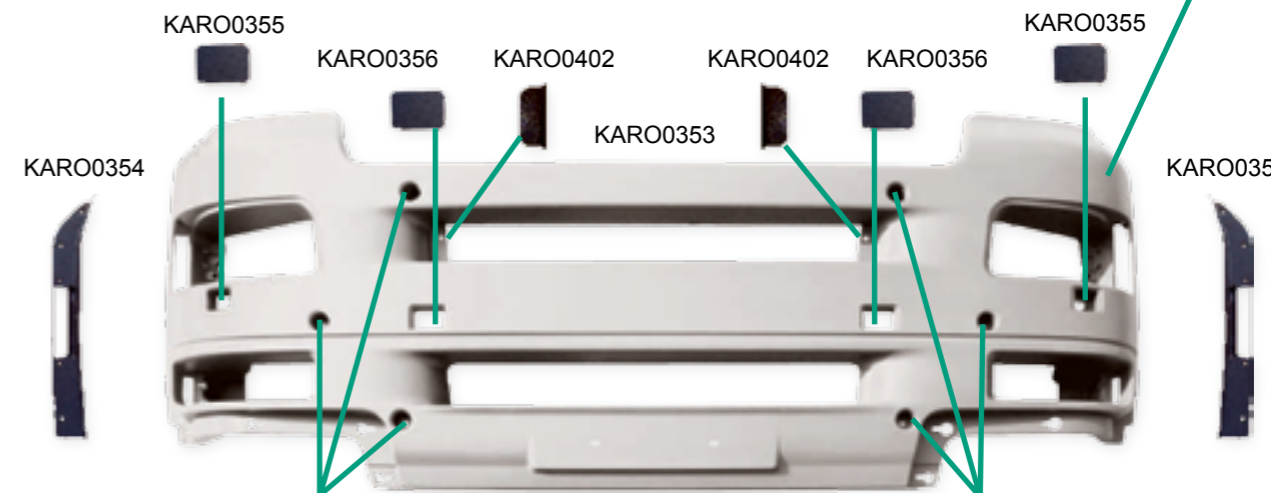

KARO0355

KARO0356

KARO0402

KARO0402

KARO0356

KARO0355

KARO0354

KARO0353

KARO0357

KARO0417

KARO0417

KARO0358

KARO0360

KARO0359

KARO0361

RASV0064

RASV0065



RASV0003

RASV0002



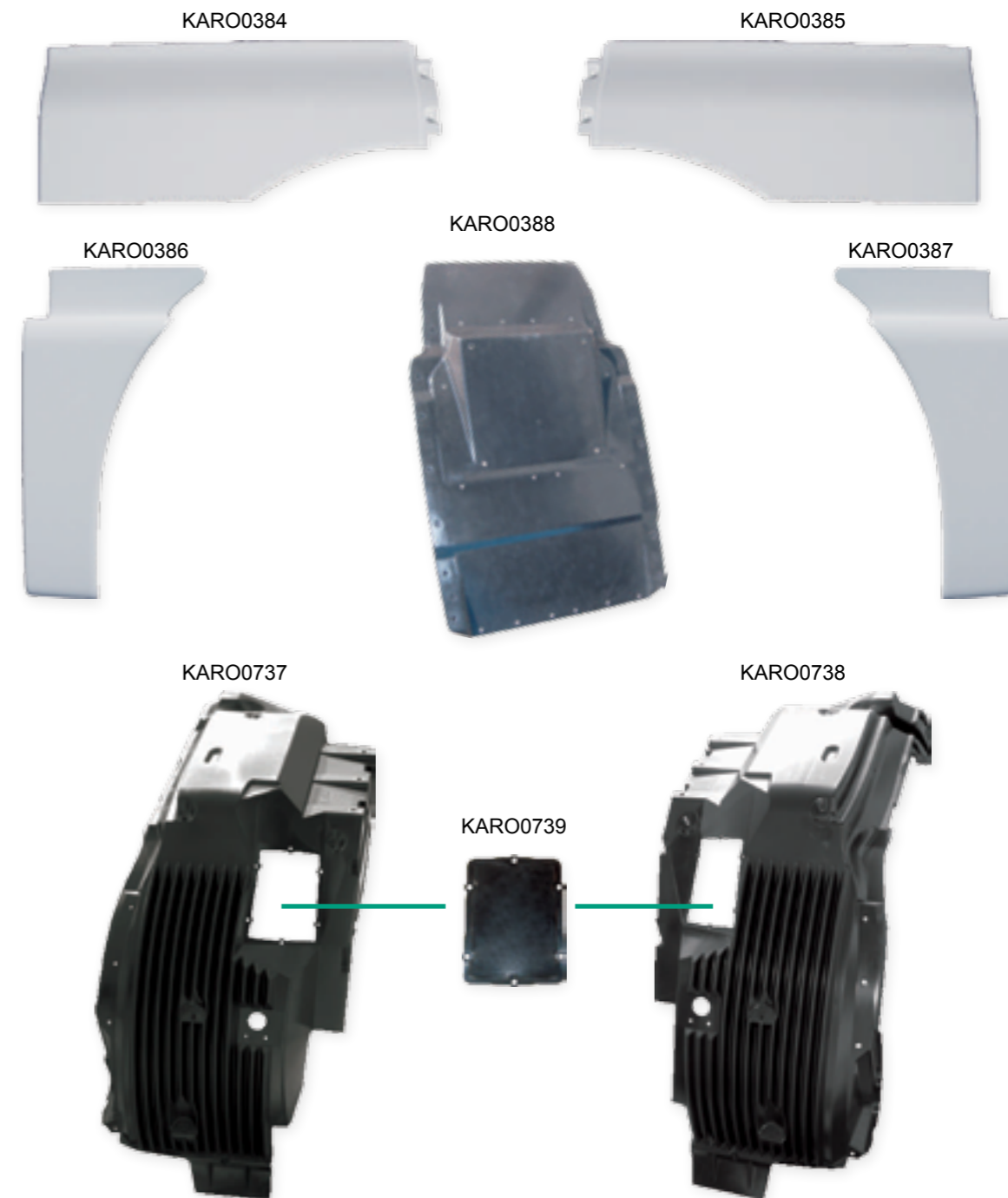
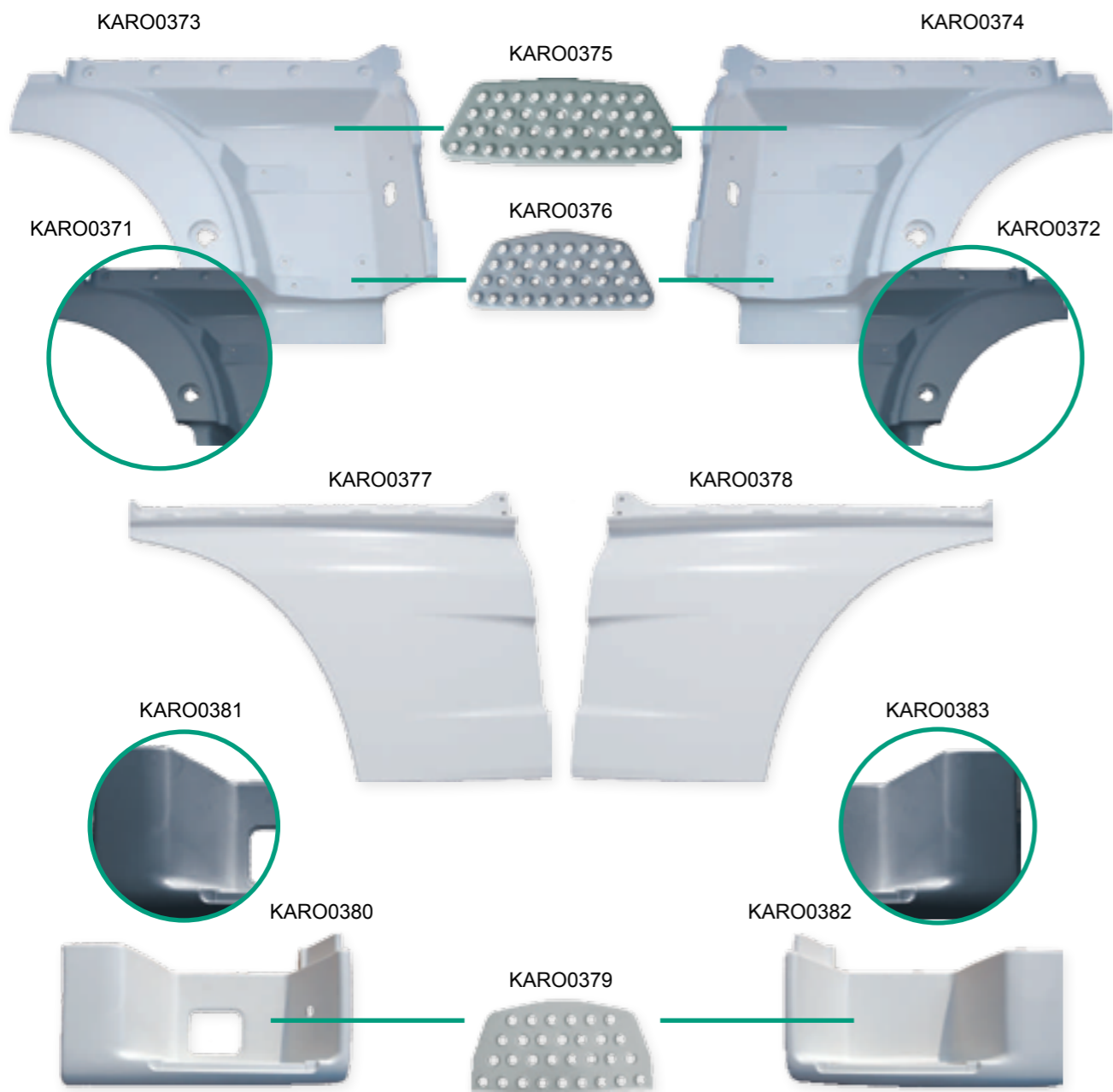



KARO1360



KARO1171



KARO0362



KARO0364



KARO0363



KARO0365



KARO0368



KARO0369



KARO1361



KARO1362



KARO0392



KARO0395



KARO0393



KARO0394



KARO0397



KARO0396



KARO0398



KARO0399



KARO0400

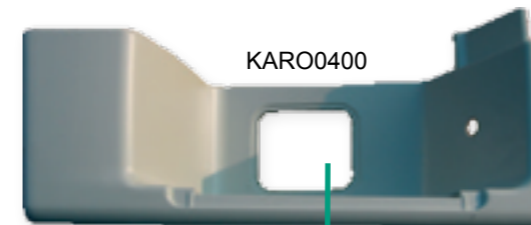

KARO0401

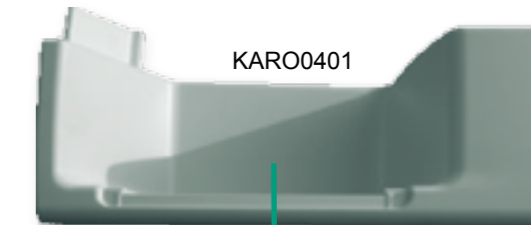

KARO0850





KARO0404



KARO0859

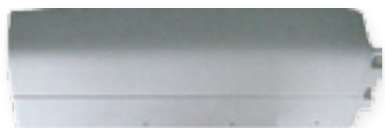

KARO0861



KARO0405



KARO0860



KARO0750



KARO0862



KARO0863



KARO0406



KARO0407



KARO1352



KARO1353



KARO1354



KARO1358



KARO1355



KARO1356



KARO1357





KARO0742



KARO0743



KARO0744



KARO0751



KARO0752



KARO0745



KARO0746



KARO0747



KARO0748



KARO0750



KARO0749





KARO1349



KARO1350



KARO1351



KARO1358



KARO1355



KARO1356



KARO1357



KARO0754



KARO1050

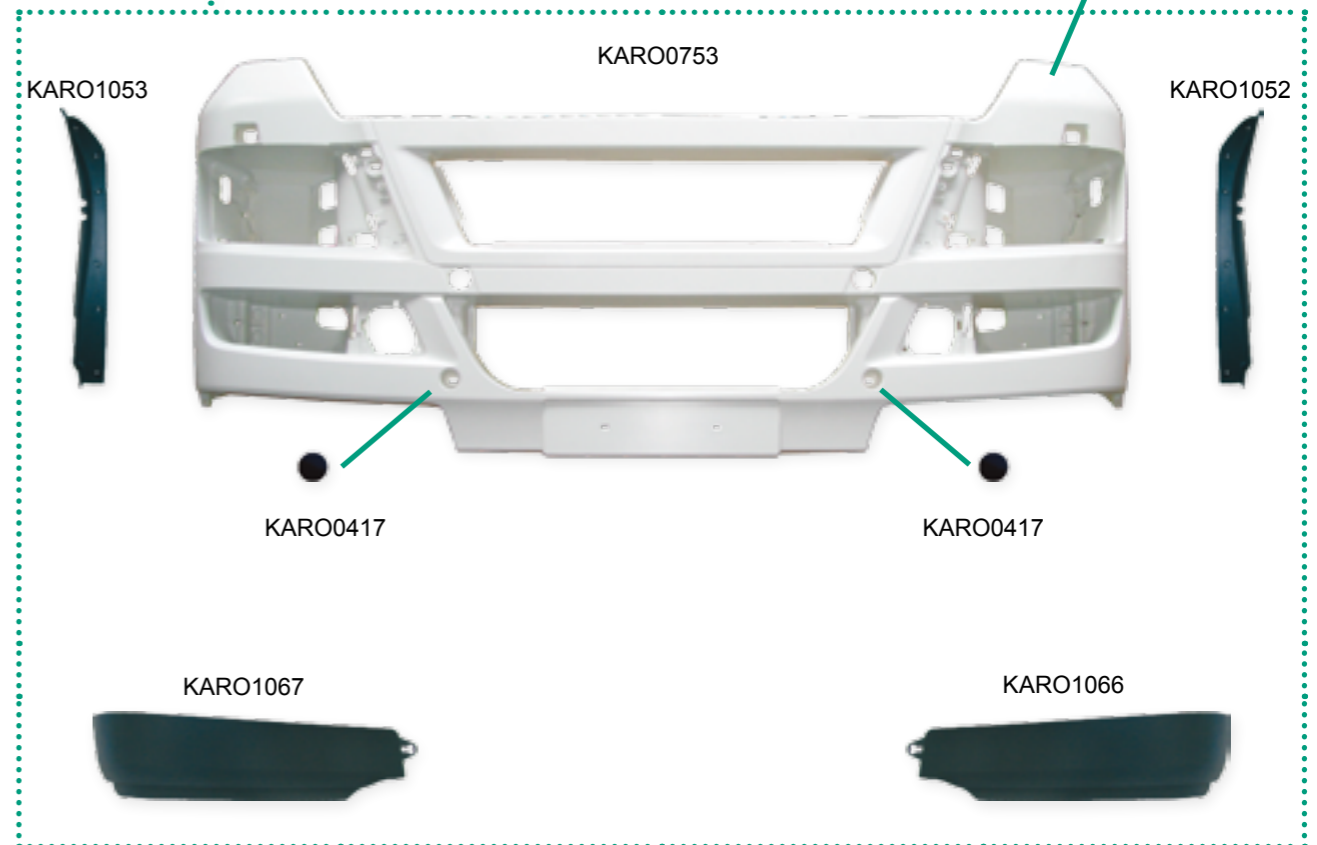

KARO1053



KARO0753

KARO1052



KARO0417



KARO0417



KARO1067



KARO1066



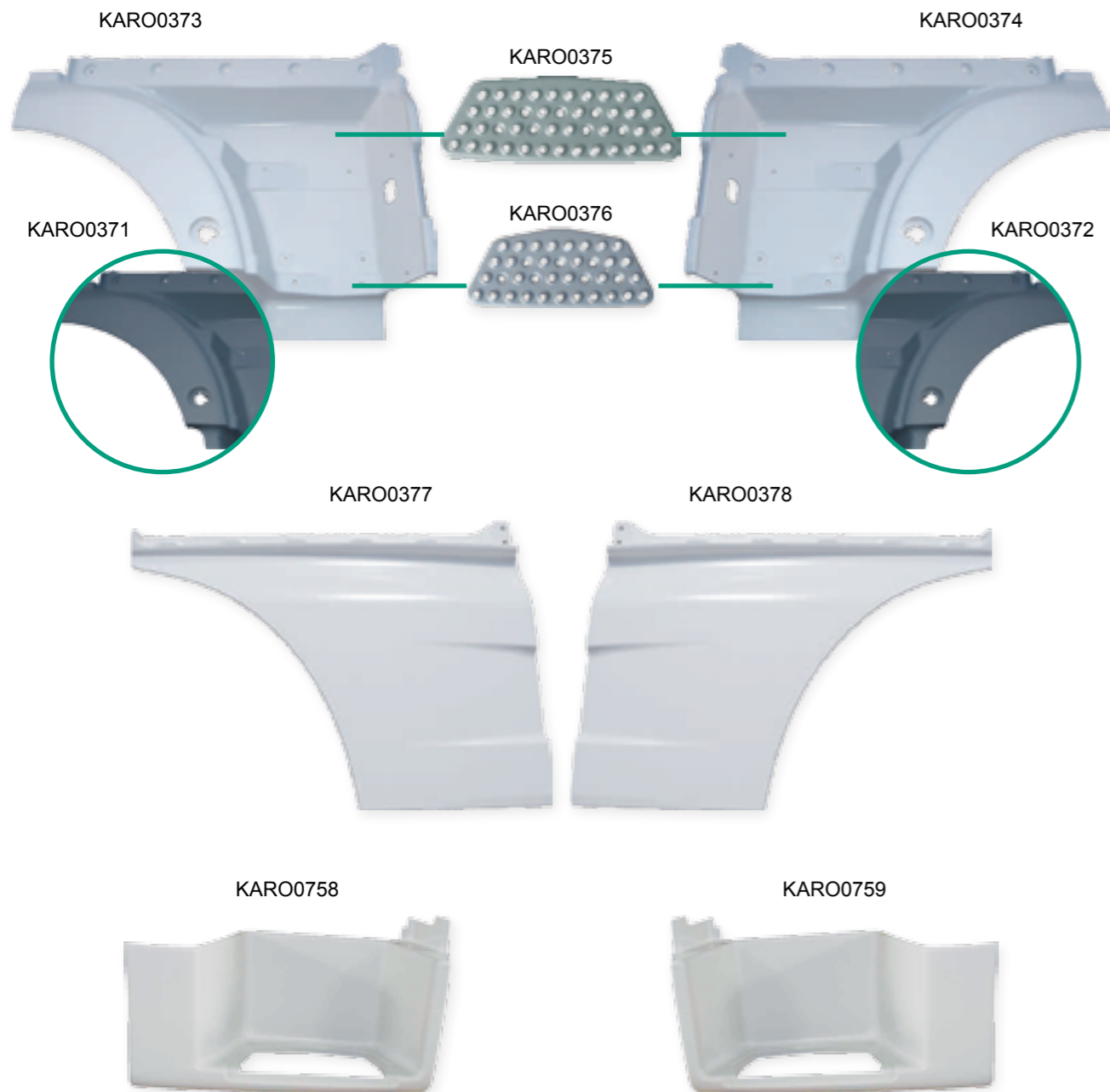



KARO1132



KARO0411



KARO1104



KARO1104



KARO1105



KARO1105



KARO0864



KABI1111



KABI0758



KABI1356

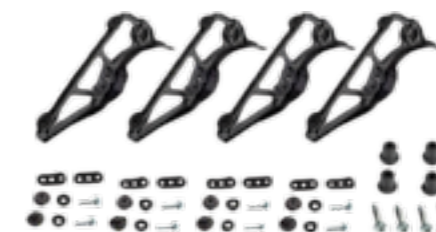

F2000

Poz.	Naziv	OE broj	RAPIDEX broj
1.	SUNCOBRAN	81.63701.0021	KABI0758
2.	SET ZA MONTAŽU	81.63735.0024	KABI1356



TGL, TGS, TGA L

Poz.	Naziv	OE broj	RAPIDEX broj
1.	SUNCOBRAN	81.63701.0060	KABI0762
2.	SET ZA MONTAŽU	81.63735.0032	KABI1258



TGA XL

Poz.	Naziv	OE broj	RAPIDEX broj
1.	SUNCOBRAN	81.63701.0044	KABI0759
2.	SET ZA MONTAŽU	81.63735.0028	KABI1355



KABI0761



KABI1256

TGS			
Poz.	Naziv	OE broj	RAPIDEX broj
1.	SUNCOBRAN	81.63701.0057	KABI0761
2.	SET ZA MONTAŽU	81.63735.0029	KABI1256



KABI1329

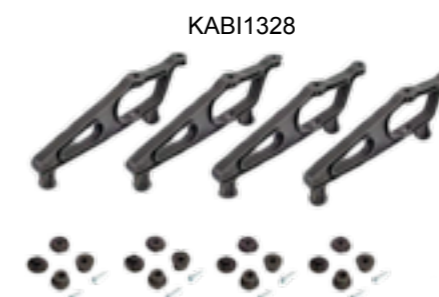

KABI1328

TGX XXL			
Poz.	Naziv	OE broj	RAPIDEX broj
1.	SUNCOBRAN	81.63701.0046	KABI1329
2.	SET ZA MONTAŽU	81.63731.0282	KABI1328

M90, F90



OE broj	MEKRA broj	Opis	Položaj	Grejač	Dimenzije (mm)	RAPIDEX broj
81.63730.6221	51.3410.147H		◀▶		377 x 189 x 65	KABI0856
81.63730.6233	51.3410.127H		◀▶		377 x 189 x 65	KABI0503
81.63733.0064	40.3640.422H		◀▶		364 x 175 x 3	KABI0504

M90, F90



OE broj	MEKRA broj	Opis	Položaj	Grejač	Dimenzije (mm)	RAPIDEX broj
81.63730.6235	56.2660.127H		◀▶		215 x 165 x 55	KABI0505
81.63730.6236	56.2660.147H		◀▶		215 x 165 x 55	KABI0506
81.63733.0061	40.2665.204H		◀▶		200 x 150 x 3	KABI0507
81.63733.6007	40.2660.404H		◀▶		200 x 150 x 3	KABI0508

L2000, M2000, F2000



OE broj	MEKRA broj	Opis	Položaj	Grejač	Dimenzije (mm)	RAPIDEX broj
81.63730.6315	51.3735.124H		◀		384 x 205 x 120	KABI0319
81.63730.6304	51.3736.124H		▶		384 x 205 x 120	KABI0359
81.63730.6316	51.3735.126H		◀		384 x 205 x 120	KABI0380
81.63730.6305	51.3736.126H		▶		384 x 205 x 120	KABI0509
81.63733.0067	15.3731.074H		◀▶		368 x 189 x 40	KABI0401
	11.3730.310H		◀▶		367 x 187 x 60	KABI0382
81.63732.0044			◀▶		374 x 196 x 40	KABI0400

L2000, M2000, F2000



OE broj	MEKRA broj	Opis	Položaj	Grejač	Dimenzije (mm)	RAPIDEX broj
81.63730.6294	59.3652.127H		◀▶		324 x 184 x 70	KABI0510
81.63733.0048	40.3655.204		◀▶		311 x 171 x 3	KABI0511

L2000, M2000, F2000



OE broj	MEKRA broj	Opis	Položaj	Grejač	Dimenzije (mm)	RAPIDEX broj
81.63730.6306	56.3860.112H		◀▶		219 x 170 x 120	KABI0861
81.63730.6307	56.3860.114H		◀▶		219 x 170 x 120	KABI0512
81.63730.6317	56.3861.116H		◀		219 x 170 x 120	KABI0513
81.63730.6308	56.3862.116H		▶		219 x 170 x 120	KABI0328
81.63733.0069	15.3812.410H				203 x 154 x 36	KABI0514
81.63733.0097	15.3811.670H		◀▶		203 x 154 x 36	KABI0329
81.63732.0045	11.3860.300H		◀▶		219 x 159 x 40	KABI0289

TGA, TGL, TGM



OE broj	MEKRA broj	Opis	Položaj	Grejač	Dimenzije (mm)	RAPIDEX broj
81.63730.6395	51.3921.222H		◀		399 x 207 x 137	KABI0386
81.63730.6399	51.3922.222H		▶		399 x 207 x 137	KABI0384
81.63733.6034	15.3922.870H		▶		379 x 176 x 47	KABI1204
81.63733.0082	15.3921.870H		◀		379 x 176 x 47	KABI0385
81.63733.6049	15.3920.840H		◀▶		379 x 176 x 47	KABI1205
81.63732.0055	11.3921.120H		▶		399 x 210 x 52	KABI1250
81.63732.0054	11.3921.110H		◀		399 x 196 x 52	KABI0327

TGA, TGL, TGM



OE broj	MEKRA broj	Opis	Položaj	Grejač	Dimenzije (mm)	RAPIDEX broj
81.63730.6409	56.3931.222H		◀		188 x 207 x 129	KABI0224
81.63730.6410	56.3932.222H		▶		188 x 220 x 130	KABI0515
81.63733.0085	15.3931.870H		◀▶		177 x 167 x 38	KABI0383
81.63733.6057	15.3932.870H		◀▶		177 x 167 x 38	KABI1203
81.63732.0057	11.3931.110H		◀		187 x 197 x 52	KABI0516
81.63732.0056	11.3931.120H		▶		187 x 197 x 52	KABI0517

TGA, TGL, TGM



OE broj	MEKRA broj	Opis	Položaj	Grejač	Dimenzije (mm)	RAPIDEX broj
81.63730.6352	59.3941.212H		◀ ▶		324 x 185 x 80	KABI0518
81.63733.6041	15.3941.670H				324 x 185 x 15	KABI0519

TGA, TGL, TGM (2006 - ...)



OE broj	MEKRA broj	Opis	Položaj	Grejač	Dimenzije (mm)	RAPIDEX broj
85.63730.6033	51.5720.140H		◀ ▶		426 x 200 x 135	KABI0520
81.63733.0103	40.5725.412H				412 x 188 x 3	KABI0521

TGA, TGL, TGM (2006 - ...)



OE broj	MEKRA broj	Opis	Položaj	Grejač	Dimenzije (mm)	RAPIDEX broj
85.63730.6039	56.5730.140H		◀ ▶		202 x 198 x 126	KABI0522
81.63733.0106	40.5735.403H				190 x 184	KABI0523

TGX, TGS



OE broj	MEKRA broj	Opis	Položaj	Grejač	Dimenzije (mm)	RAPIDEX broj
81.63730.6560	59.5800.102H		◀		943 x 382 x 153	KABI1036
81.63730.6531	59.5800.201H		▶		943 x 382 x 153	KABI1037
81.63730.6533	59.5800.121H		◀		943 x 437 x 153	KABI1112
81.63730.6549	59.5800.122H		◀		943 x 437 x 153	KABI1309
81.63730.6534	59.5800.221H		▶		943 x 437 x 153	KABI1051
81.63730.6550	59.5800.222H		▶		943 x 437 x 153	KABI1308
81.63733.6071	15.5801.840H		◀ ▶		381 x 201	KABI1038
81.63731.0356	11.5800.100H		◀ ▶		631 x 237 x 174	KABI1041
81.63733.6072	15.5811.872H		▶		197 x 181 x 42	KABI1040
81.63733.6073	15.5811.871H		◀		197 x 181 x 42	KABI1039

TGX, TGS



OE broj	MEKRA broj	Opis	Položaj	Grejač	Dimenzije (mm)	RAPIDEX broj
81.63730.6656						KABI1126

LEGENDA:



MANUELNO
PODEŠAVANJE



STAKLO



GREJAČ

◀ LEVI POLOŽAJ



ELEKTRIČNO
PODEŠAVANJE



PLOKLOPAC
KUĆIŠTE



◀ ▶ UNIVERZALAN
POLOŽAJ

▶ DESNI POLOŽAJ

CILINDRI ZA DIZANJE KABINE			
Poz.	Model	OE broj	RAPIDEX broj
1.	F90, F2000	83.41723.6099	HIDR0075
			
2.	F90, F2000	83.41723.6500	KABI0555
			
3.	F90, F2000	83.41723.6029	KABI0556
			
4.	F90, F2000	81.41723.6076	KABI0335
			
5.	TGA 410-430	83.41723.6123	HIDR0074
			
6.	TGA 460	83.41723.6124	HIDR0073
			

PUMPE ZA DIZANJE KABINE				
Poz.	Slika	Model	OE broj	RAPIDEX broj
1.		F90, F2000	81.41723.6008	KABI0562
2.		F90, F2000	83.41723.6114	KABI0563
3.		TGA, TGM, TGX, TGS	85.41723.6020	HIDR0047
4.		TGA, TGX, TGS	81.41723.6122	HIDR0015

ELEMENTI ZA OSLANJANJE KABINE			
Poz.	Slika	Model / OE broj	RAPIDEX broj
1.		F90, F2000 1. 81.96210.0407 x 2 2. 81.96210.0437 x 2 3. 81.96101.0638 x 2 4. 81.97112.0844 x 2 5. 06.36950.0510 x 2 6. 81.96503.0129 x 4	KABI0454
2.		F90, F2000 1. 81.96210.0407 x 2 2. 81.96210.0437 x 4 3. 81.96101.0638 x 2 4. 81.97112.0844 x 2 5. 06.36950.0510 x 2 6. 81.96503.0129 x 4	KABI0453
3.		F90, F2000 1. 81.96210.0400 x 4 2. 06.36950.0510 x 2	KABI0451
4.		TGA 81.41715.6013 1. 85.96210.0019 x 2 2. 06.02813.5027 x 2 3. 06.02813.5024 x 2 4. 85.90710.0014 x 4 5. 06.29020.0127 x 2 6. 06.36950.0210 x 2 7. 85.96501.0002 x 4 8. 06.11251.2008 x 4 9. 85.41715.0006 x 4	KABI0394

ELEMENTI ZA OSLANJANJE KABINE				
Poz.	Slika	Model / OE broj	RAPIDEX broj	
5.		TGA 81.41715.6014 1. 85.96210.0019 x 2 2. 06.02813.5027 x 2 3. 06.02813.5024 x 2 4. 85.90710.0014 x 4 5. 85.96210.0021 x 2 6. 06.11251.2008 x 4	KABI0393	

ELEMENTI ZA OSLANJANJE KABINE					
Poz.	Slika	Model	Dimenzije (mm)	OE broj	RAPIDEX broj
1.		TGA		85.96210.0019S	KABI1267
2.		TGA		85.96020.0004	KABI1061
3.		F90, F2000		81.61851.6023	KABI0390
4.		TGA		85.61851.6003	KABI0366
5.		F90		81.48227.0006	KOCN1368
6.		F90, F2000		81.96420.0324	KABI0456

ELEMENTI ZA OSLANJANJE KABINE					
Poz.	Slika	Model	Dimenzije (mm)	OE broj	RAPIDEX broj
7.		L2000, M2000		81.96420.0529	KABI0260
8.		F90, F2000		81.32616.0007	KABI0350
9.		L2000, M2000		81.32616.0008	KABI0259
10.		F90		81.96210.0089	KABI0579
11.		F90		81.96210.0437	KABI0370
12.		F90	50 x 16 x 29	81.96210.0400	KABI0580
13.		F90	60 x 15 x 18	81.96210.0407	KABI0372
14.		F90	M10	81.96210.0430	KABI0581
15.		F90	Ø50 x 40 M10 x 25	81.96210.0101	VESA0592

ELEMENTI ZA OSLANJANJE KABINE					
Poz.	Slika	Model	Dimenzije (mm)	OE broj	RAPIDEX broj
16.		F90	65 x 33 x 6	81.90712.0844	KABI0377
17.		F90	70 x 32 x 4	81.96101.0638	KABI0376
18.		F90, F2000	GE-30UK2RS	06.36950.0510	KABI0582
19.		F2000		81.96503.0129	KABI0583
20.		F90, F2000, TGA	30 x 14 x 42	81.96210.0462	KABI0341
21.		TGA	75 x 17 x 122	85.41715.0006	KABI0584
22.		TGA		85.90710.0014	KABI0585
23.		TGA		81.41723.0067	KABI0586
24.		TGA	65 x 49 x 11	85.96501.0002	KABI0587

ELEMENTI ZA OSLANJANJE KABINE					
Poz.	Slika	Model	Dimenzije (mm)	OE broj	RAPIDEX broj
25.		TGA, TGX	53 x 17 x 88	81.96210.0609	KABI1417
26.		TGA, TGX	53 x 22 x 42	85.96020.0004	KABI0218
27.		TGA	53 x 16 x 58	85.96210.0021	KABI0340
28.		TGA	60 x 16 x 80	85.96210.0019	KABI0455



UREĐAJI ZA PRANJE VETROBRANSKOG STAKLA				
Poz.	Model	Opis	OE broj	RAPIDEX broj
1.	M2000, F2000	MEHANIZAM BRISAČA	81.26411.6091	KABI0621
2.	F2000	MEHANIZAM BRISAČA	81.26411.6089	KABI0622
3.	M2000, F2000	METLICA BRISAČA 600 mm	81.26440.6034	KABI0421
4.	TGL, TGM, TGA, TGS, TGX	METLICA BRISAČA 700 mm	81.26440.0068	RASV1232
5.	F90, F2000	MOTOR BRISAČA	81.26401.6119	KABI0247
6.	TGL, TGM, TGA, TGS, TGX	MOTOR BRISAČA	81.26401.6141	KABI0286
7.	M90, F90, L2000, M2000, F2000	POLUGA BRISAČA	81.26411.0098	KABI0191
8.	M90, F90, L2000, M2000, F2000	POLUGA BRISAČA	81.26411.0097	KABI0281
9.	M90, F90, L2000, M2000, F2000	POLUGA BRISAČA	81.26411.0096	KABI0282
10.	F90, F2000	POLUGA BRISAČA	81.26411.0094	KABI0283
11.	F90, F2000	POLUGA BRISAČA	81.26411.0093	KABI0284
12.	F90, F2000	POLUGA BRISAČA	81.26411.0095	KABI0285
13.	F90, F2000	PUMPICA BRISAČA	81.26485.6027	OPRE0015
14.	TGL, TGM, TGA, TGS, TGX	PUMPICA BRISAČA	81.26485.6032	OPRE0016
15.	M90, F90, L2000, M2000, F2000	RUČICA BRISAČA	81.26430.0081	KABI0279
16.	F90, F2000	RUČICA BRISAČA	81.26430.0080	KABI0280
17.	TGL, TGM, TGA, TGS, TGX	RUČICA BRISAČA	81.26430.6046	KABI0639



MEHANIZAM VRATA					
Poz.	Model	Opis	Položaj	OE broj	RAPIDEX broj
1.	M90, F90, M2000, F2000	BRAVA VRATA	◀ ▶	81.97100.6099	KABI0657
2.	M90, F90, M2000, F2000	BRAVA VRATA	◀	81.62680.6095	KABI0658
3.	M90, F90, M2000, F2000	BRAVA VRATA	▶	81.62680.6096	KABI0659
4.	TGA, TGS, TGX	BRAVA VRATA	◀	81.62680.6121	KABI0660
5.	TGA, TGS, TGX	BRAVA VRATA	▶	81.62680.6122	KABI0661
6.	TGA, TGS, TGX	MODUL VRATA	◀	81.25806.7077	KABI0027
7.	TGA, TGS, TGX	MODUL VRATA	▶	81.25806.7073	KABI1105
8.	M2000, F2000	MOTOR PODIZAČA	◀	81.28601.6069	KABI0693
9.	M2000, F2000	MOTOR PODIZAČA	▶	81.28601.6068	KABI0694
10.	TGA, TGS, TGX	MOTOR PODIZAČA	◀	81.28601.6143	KABI0001

MEHANIZAM VRATA					
Poz.	Model	Opis	Položaj	OE broj	RAPIDEX broj
11.	TGA, TGS, TGX	MOTOR PODIZAČA	▶	81.28601.6126	KABI0695
12.	M2000, F2000	PODIZAČ PROZORA	◀	81.62640.6055	KABI0287
13.	M2000, F2000	PODIZAČ PROZORA	▶	81.62640.6056	KABI0288
14.	TGA, TGS, TGX	PODIZAČ PROZORA ELEKTRONSKI	◀	81.62645.6035	KABI0676
15.	TGA, TGS, TGX	PODIZAČ PROZORA ELEKTRONSKI	▶	81.62645.6034	KABI0677
16.	M2000, F2000	RUČICA VRATA	◀	81.62641.0099	KABI0294
17.	M2000, F2000	RUČICA VRATA	▶	81.62641.0100	KABI0295
18.	TGA, TGS, TGX	RUČICA VRATA	◀	81.62641.6067	KABI0696
19.	TGA, TGS, TGX	RUČICA VRATA	▶	81.62641.6068	KABI0697
20.	TGA, TGS, TGX	VENTIL GREJANJA	-	81.61967.0016	KABI0689
21.	TGA	KVAKA VRATA	◀	81.62641.6081	KABI0466

7.0 ELEKTRIČNE INSTALACIJE



7.0 ELEKTRIČNE INSTALACIJE

7.1	Farovi	200
7.2	Pokazivači pravca	204
7.3	Stop i gabaritna svetla	206
7.4	Rotacione lampe	210
7.5	Sijalice, osigurači i tahograf listići	213
7.6	Kablovi električne instalacije	218
7.7	Kombinovani prekidači pod volanom	221
7.8	Akumulatori i pribor	222
7.9	Anlaseri i alternatori	226

**F2000 (1994 - ...),
M2000 (1995 - ...)**

OE broj	OPIS	RAPIDEX broj
81.25101.6292	▶	RASV0152
81.25101.6291	◀	RASV0151
81.25110.0068	▶ STAKLO	RASV0256
81.25110.0067	◀ STAKLO	RASV0380



81.25101.6338	▶	RASV0022
81.25101.6339	◀	RASV0023

**TGA (1999 - ...), M2000 (2002 - 2005),
LE (2001 - 2005), TGL, TGM (2005 - ...)**

OE broj	OPIS	RAPIDEX broj
81.25101.6348	▶	RASV1016
81.25101.6347	◀	RASV1015
81.52101.6352	▶	RASV0510
81.52101.6351	◀	RASV0509
81.25110.0081	▶ STAKLO	RASV0041
81.25110.0080	◀ STAKLO	RASV0040



81.25320.6092	▶	RASV0003
81.25320.6091	◀	RASV0002



81.25320.6114	▶	RASV0623
81.25320.6113	◀	RASV0624



81.25320.6090	▶	RASV0061
81.25320.6089	◀	RASV0062

TGX, TGS

OE broj	OPIS	RAPIDEX broj
81.25101.6500	▶	RASV0009
81.25101.6501	◀	RASV0010
81.25101.6498	▶	RASV0625
81.25101.6499	◀	RASV0626
81.25110.0084	▶ STAKLO	RASV0627
81.25110.0083	◀ STAKLO	RASV0628



81.25101.6522	▶	RASV0629
81.25101.6521	◀	RASV0630
81.25110.0086	▶ STAKLO	RASV1309
81.25110.0085	◀ STAKLO	RASV1308



UNIVERZALNI FAR

KBP	OPIS	RAPIDEX broj
1G3 005 760-021	 Ø152 mm	RASV0718

UNIVERZALNI FAR

KBP	OPIS	RAPIDEX broj
1GA 005 060-001	 153 x 93 mm	RASV0230

UNIVERZALNI FAR

KBP	OPIS	RAPIDEX broj
1GA 006 991-021	 158 x 105 mm	RASV0719

UNIVERZALNI FAR

KBP	OPIS	RAPIDEX broj
1GA 006 991-081 44.120.000	 112 x 102mm	RASV0168

UNIVERZALNI FAR

KBP	OPIS	RAPIDEX broj
44.040.500	 170 x 100 mm	RASV0167

LED UNIVERZALNI FAR

KBP	OPIS	RAPIDEX broj
91017420	 LED 9-30 V, 1200 LUMEN 105 x 124	RASV0546

LED UNIVERZALNI FAR



KBP	OPIS	RAPIDEX broj
098174090	 LED 9-30 V, 1200 LUMEN 140 x 114	RASV1342

F90 (1986 - 1997),
M90 (1988 - 1994)

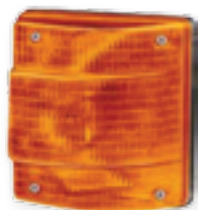

OE broj	OPIS	RAPIDEX broj
81.25320.6068		RASV0289

L2000 (1993 - ...)



OE broj	OPIS	RAPIDEX broj
81.25320.6073		RASV0288

F2000 (1994 - ...),
M2000 (1995 - ...)



OE broj	OPIS	RAPIDEX broj
81.25320.6084		RASV0734

F2000 (1994 - ...),
M2000 (1995 - ...)



OE broj	OPIS	RAPIDEX broj
81.2530.6082		RASV0173

TGA (1999 - ...),
M2000 (2002 - 2005), LE (2001 - 2005), TGL, TGM (2005 - ...)







OE broj	OPIS	RAPIDEX broj
81.25320.6115		RASV0972

TGA (2005 - ...), TGL, TGM (2005 - ...)

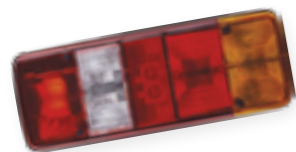



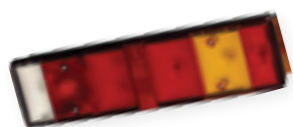

OE broj	OPIS	RAPIDEX broj
81.25320.6118		RASV0067

M90 (1988 - 1991), F90 (1986 - 1991)

OE broj	OPIS	RAPIDEX broj
81.25229.6010	▶ 	RASV0219
81.25229.6011	◀  343 x 133 mm	RASV0220
81.25229.6040	▶ STAKLO ◀ STAKLO 	RASV0487

L2000 (1993 - ...), M2000 (1995 - ...), F90 (1991 - ...), F2000 (1994 - ...)



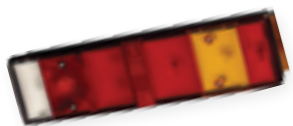

OE broj / KBP	OPIS	RAPIDEX broj
81.25228.6030	▶  	RASV0302
81.25228.6029	◀   468 x 134 mm	RASV0301



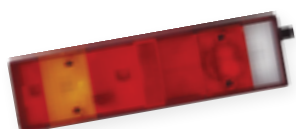

2VP008204121	▶ 	RASV0419
2VD008204131	◀  468 x 134 mm	RASV0418

81.25229.6051	▶ STAKLO ◀ STAKLO 	RASV0306
---------------	--	----------



TGA (2000 - ...)

OE broj	OPIS	RAPIDEX broj
81.25225.6523	▶ 	RASV0311
81.25225.6524	◀  468 x 134 mm	RASV0299
81.25225.6530	▶ SA RIKVERC ALARMOM	RASV0749
81.25229.6051	▶ STAKLO ◀ STAKLO 	RASV0306

TGA (2005 - ...), TGL, TGM (2005 - ...)

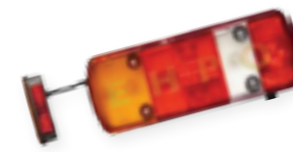
OE broj	OPIS	RAPIDEX broj
81.25225.6545	▶ 	RASV0451
81.25225.6544	◀  400 x 160 mm	RASV0454
81.25225.6547	▶ SA RIKVERC ALARMOM	RASV0750
81.25229.6060	▶ STAKLO	RASV0388
81.25229.6059	◀ STAKLO 	RASV0465

LE (2003 - ...)

OE broj	OPIS	RAPIDEX broj
81.25225.6532	▶ 	RASV0751
81.25225.6531	◀  340 x 130 mm	RASV0752
81.25225.6538	▶ STAKLO ◀ STAKLO 	RASV0753

RIKVERC ALARMI

Poz.	Slika	Naziv / Opis	RAPIDEX broj
1.		RIKVERC ALARM 12/24 V, 97 dB	OSTA0370
2.		RIKVERC ALARM 12/24 V, 97 dB	OSTA0247

F90, F2000

OE broj	OPIS	RAPIDEX broj
81.25260.6057	 24V 5W Ba 15s	RASV0034

TGA, TGS, TGX

OE broj	OPIS	RAPIDEX broj
81.25260.6121	 24V LED	RASV1239

L2000, M2000, F2000, ME, LE, TGM, TGS, TGA, TGX

OE broj	OPIS	RAPIDEX broj
81.25260.6079	 24V 5W W2,1X9,5D	RASV0260

OE broj	OPIS	RAPIDEX broj
81.25260.6104	 LED	RASV0261

OE broj	OPIS	RAPIDEX broj
-	 LED	RASV0262

SVETLA REGISTRAR TABLICE

KBP	OPIS	RAPIDEX broj
2KA 003 389-061	  12/24V R10W-Ba15s	RASV0396
26-3010-004	  12/24V C5W-SV8,5	RASV0075
26-3000-004	  12/24V C5W-SV8,5	RASV0105
39.280.000	  LED	RASV0860

KATADIOPTERI

KBP	OPIS	RAPIDEX broj
8RA 002 014-041	BELI	Ø 60 mm
8RA 002 014-051	ŽUTI	
8RA 002 014-031	CRVENI	
8RA 003 326-021	BELI	94 x 44 mm
8RA 003 326-011	ŽUTI	
8RA 003 326-001	CRVENI	
01.090.7520.05		RASV0222

KL 7000 F

KBP	OPIS		RAPIDEX broj
2RL 008 061-101	12V		RASV0862
2RL 008 061-111	24V		RASV0863
9EL 862 141-001	ŽUTO STAKLO		RASV0864
9EL 862 140-001	PLAVO STAKLO		RASV0865

KL 7000 M

KBP	OPIS		RAPIDEX broj
2RL 008 062-101	12/24V		RASV0866
2RL 008 062-111	24/12V		RASV0867
9EL 862 141-001	ŽUTO STAKLO		RASV0864
9EL 862 140-001	PLAVO STAKLO		RASV0865

KL 7000 M

KBP	OPIS		RAPIDEX broj
2RL 008 062-001	12/24V		RASV0868
2RL 008 062-011	24/12V		RASV0869
9EL 862 141-001	ŽUTO STAKLO		RASV0864
9EL 862 140-001	PLAVO STAKLO		RASV0865

KL 7000 R

KBP	OPIS		RAPIDEX broj
2RL 008 060-101	12/24V		RASV0870
2RL 008 060-111	24/12V		RASV0871
9EL 862 141-001	ŽUTO STAKLO		RASV0864
9EL 862 140-001	PLAVO STAKLO		RASV0865

JUNIOR PLUS F

KBP	OPIS		RAPIDEX broj
2RL 008 965-001	12V		RASV0467
2RL 008 965-011	24V		RASV0872
9EL 863 100-001	ŽUTO STAKLO		RASV0873

JUNIOR F

KBP	OPIS		RAPIDEX broj
2RL 007 550-001	12V		RASV0533
2RL 007 550-011	24V		RASV0558
9EL 860 627-001	ŽUTO STAKLO		RASV0505
9EL 860 628-021	PLAVO STAKLO		RASV0874

JUNIOR M

KBP	OPIS		RAPIDEX broj
2RL 007 552-001	12V		RASV0560
2RL 007 552-011	24V		RASV0559

9EL 860 627-001	ŽUTO STAKLO	RASV0505
9EL 860 628-021	PLAVO STAKLO	RASV0874

JUNIOR R

KBP	OPIS		RAPIDEX broj
2RL 007 551-001	12V		RASV0055
2RL 007 551-011	24V		RASV0053

9EL 860 627-001	ŽUTO STAKLO	RASV0505
9EL 860 628-021	PLAVO STAKLO	RASV0874

H1 - P14,5s

OPIS	RAPIDEX broj
12V H1-55W	RASV1089
24V H1-70W	RASV1088

H2 - H511

OPIS	RAPIDEX broj
12V H2-55W	RASV0880
24V H2-70W	RASV0881

H3 - PK22s

OPIS	RAPIDEX broj
12V H3-55W	RASV1105
24V H3-70W	ELEK0294

H4 - P43t

OPIS	RAPIDEX broj
12V H4-60/55W	RASV1085
24V H4-75/70W	ELEK0295

H7 - Px26d

OPIS	RAPIDEX broj
12V H7-55W	RASV1084
24V H7-70W	RASV1078

H8 - PGJ19-1

OPIS	RAPIDEX broj
12V H8-35W	RASV0882

H9 - PGJ19-5

OPIS	RAPIDEX broj
12V H9-55W	RASV0877

H10 - PY20d

OPIS	RAPIDEX broj
12V H10-42W	RASV0883

H11 - PGJ19-2

OPIS	RAPIDEX broj
12V H11-55W	RASV0878
24V H11-70W	RASV0879

H21W - BAY9s

OPIS	RAPIDEX broj
12V H21W	RASV0884
24V H21W	RASV1079

D2R - P32d3

OPIS	RAPIDEX broj
D2R-35W	RASV0885

D2S - P32d2

OPIS	RAPIDEX broj
D2S-35W	RASV0886

R2 - P45t

OPIS	RAPIDEX broj
12V R2-45/40W	RASV0550
24V R2-55/50W	RASV0571

P21W - BA15s

OPIS	RAPIDEX broj
12V P21W	RASV1083
24V P21W	ELEK0293

PY21W - BAU15s

OPIS	RAPIDEX broj
12V PY21W	RASV0562
24V PY21W	RASV0499

P21/5W - BAY15d

OPIS	RAPIDEX broj
12V P21/5W	RASV0535
24V P21/5W	RASV1076

R5W - BA15s

OPIS	RAPIDEX broj
12V R5W	RASV1082
24V R5W	RASV1072

R10W - BA15s

OPIS	RAPIDEX broj
12V R10W	RASV0490
24V R10W	RASV1075

C5W - SV8,5

OPIS	RAPIDEX broj
12V C5W	RASV0887
24V C5W	RASV1074

C10W - SV8,5

OPIS	RAPIDEX broj
12V C10W	RASV0888
24V C10W	RASV0315

T3W - BA9s

OPIS	RAPIDEX broj
12V T3W	RASV0502
24V T3W	RASV0501

T4W - BA9s

OPIS	RAPIDEX broj
12V T4W	ELEK0291
24V T4W	RASV1071

W3W - W2,1x9,5d

OPIS	RAPIDEX broj
12V W3W	RASV0564
24V W3W	RASV0569

W5W - W2,1x9,5d

OPIS	RAPIDEX broj
12V W5W	RASV0484
24V W5W	RASV1073

W1,2W - W2x4,6d

OPIS	RAPIDEX broj
12V W1,2W	RASV0563
24V W1,2W	RASV1069

W1,2W - B8,3d

OPIS	RAPIDEX broj
12V W1,2W	RASV0893
24V W1,2W	RASV1070

GARNITURA SIJALICA H7

OPIS	RAPIDEX broj
12V H7	RASV1180
24V H7	RASV1081

GARNITURA SIJALICA H4

OPIS	RAPIDEX broj
12V H4	RASV1086
24V H4	RASV1080

GARNITURA SIJALICA H7

OPIS	RAPIDEX broj
2 x 24V H7	RASV0892

GARNITURA SIJALICA H4

OPIS	RAPIDEX broj
2 x 24V H4	RASV0895

OSIGURAČI UBODNI

Slika	Poz.	Opis	KBP	RAPIDEX broj
	1.	5A OKER	8JS 711 684-002	ELEK0684
	2.	7,5A BRAON	8JS 711 685-002	ELEK0258
	3.	10A CRVENI	8JS 711 686-002	RASV0568
	4.	15A PLAVI	8JS 711 687-002	RASV0567
	5.	20A ŽUTI	8JS 711 688-002	ELEK0257
	6.	25A BELI	8JS 711 689-002	ELEK0575
	7.	30A ZELENI	8JS 711 690-002	RASV0539
	8.	40A NARANDŽASTI	8JS 711 683-031	ELEK0769

OSIGURAČI UBODNI - MINI

Slika	Poz.	Opis	KBP	RAPIDEX broj
	1.	5A	8JS 728 596-131	RASV0183
	2.	7,5A	8JS 728 596-111	RASV0184
	3.	10A	8JS 728 596-141	RASV0185
	4.	15A	8JS 728 596-151	RASV0186
	5.	20A	8JS 728 596-161	RASV0187
	6.	25A	8JS 728 596-091	RASV0188
	7.	30A	8JS 728 596-171	RASV0189

OSIGURAČI UBODNI - MAXI

Slika	Poz.	Opis	KBP	RAPIDEX broj
	1.	20A	8JS 728 595-051	RASV0920
	2.	30A	8JS 728 595-141	RASV0921
	3.	40A	8JS 728 595-151	RASV0922
	4.	50A	8JS 728 595-161	RASV0923
	5.	60A	8JS 728 595-171	RASV0924
	6.	70A	8JS 728 595-101	RASV0925
	7.	80A	8JS 728 595-111	RASV0927

OSIGURAČI - MIDI

Slika	Poz.	Opis	KBP	RAPIDEX broj
	1.	30A	8JS 742 901-061	RASV0928
	2.	50A	8JS 742 901-011	RASV0929
	3.	150A	8JS 742 901-081	RASV0052

OSIGURAČI - MEGA

Slika	Poz.	Opis	KBP	RAPIDEX broj
	1.	125A	8JS 742 902-011	RASV0930
	2.	150A	8JS 742 902-021	RASV0931
	3.	200A	8JS 742 902-041	RASV0932
	4.	250A	8JS 742 902-051	RASV0933
	5.	300A	8JS 742 902-071	RASV0934

TAHOGRAFI LISTIĆI





Slika	Poz.	Opis	RAPIDEX broj
	1.	100-24 EC4K	OPRE0210
	2.	100-3300-24 EC4	OPRE0220
	3.	125-24 EC4K	OPRE0224
	4.	125-3300-24 EC4KA	OPRE0122
	5.	140-24 EC4K	OPRE0216
	6.	SERTIFIKAT-VIKEND	OPRE0105
	7.	ROLNICA ZA DIGITALNI TAHOGRAF	ELEK1112





SPIRALNI KABLOVI				
Slika	Poz.	Opis	KBP	RAPIDEX broj
	1.	7 - ŽILNI	611 110	ELEK0609
	2.	ISO 1724 7 - lni	8KA 004 797-021	ELEK0770
	3.	ISO 1185 7 - lni	8KA 004 797-041	ELEK0287
	4.	ISO 3731 7 - lni	8KA 004 797-051	ELEK0370
	5.	ISO 7638 ABS/EBS	446 008 700 0	ELEK1368
	6.	ISO 12098 15 - lni	446 008 710 0	ELEK1122
	7.	15/2 x 7 - lni	8JA 005 952-041	ELEK0450

ADAPTER				
Slika	Poz.	Opis	KBP	RAPIDEX broj
	1.	15/2 x 7 - lin	8JA 005 952-061	ELEK0247

UTIKAČI				
Slika	Poz.	Opis	KBP	RAPIDEX broj
	1.	ISO 1724 7 - lni 12V	8JA 001 930-003	ELEK0607
	2.	ISO 1185 7 - lni	8JA 008 831-001	RASV0541
	3.	ISO 3731 7 - lni	8JA 008 832-011	ELEK0491
	4.	ISO 7638 ABS/EBS	8JB 007 645-031	ELEK0470
	5.	ISO 12098 15 - lni	8JA 007 241-031	ELEK0250

UTIČNICE				
Slika	Poz.	Opis	KBP	RAPIDEX broj
	1.	ISO 1724 7 - Ini 12V	8JB 001 943-003	ELEK0606
	2.	ISO 1185 7 - Ini	8JB 003 833-001	RASV0513
	3.	ISO 3731 7 - Ini	8JB 003 834-001	RASV0452
	4.	ISO 7638 ABS/EBS	8JB 007 645-031	ELEK0402
	5.	ISO 12098 15 - Ini	8JB 007 242-011	ELEK0249

KOMBINOVANI PREKIDAČI POD VOLANOM				
Poz.	Slika	Model	OE broj	RAPIDEX broj
1.		M90, F90	81.25509.0020	ELEK0003
2.		L2000, M2000, F2000	81.25509.0093	ELEK0002
3.		TGA, TGL, TGM, TGS, TGX	81.25509.0123	ELEK0004

VARTA

BY JOHNSON CONTROLS



Skraćenica	Volt	Ah	Dužina (mm)	Širina (mm)	Visina (mm)	A	Spoj	Polovi	Podna prirubnica	RAPIDEX broj
12w	12	110	514	175	210	760	3	1	B03	ELEK1161
J2w	12	125	345	172	290	720	1	1	B00	OPRE0246
K8	12	140	513	189	223	800	3	1	B03	ELEK0837
K4w	12	143	514	218	210	950	3	1	B03	OPRE0250
M8	12	170	513	223	223	1000	3	1	B00	OPRE0233
M18	12	180	513	223	223	1000	3	1	B00	OPRE0251
N9	12	225	518	276	242	1150	3	1	B00	OPRE0529

TEHNIČKO OBJAŠNJENJE:

Položaji polova

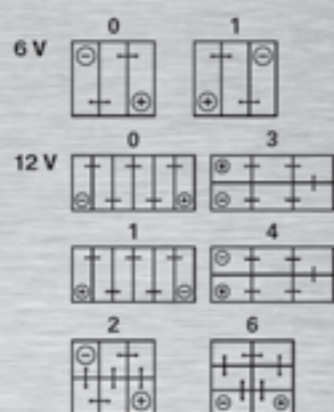

Podna prirubnica

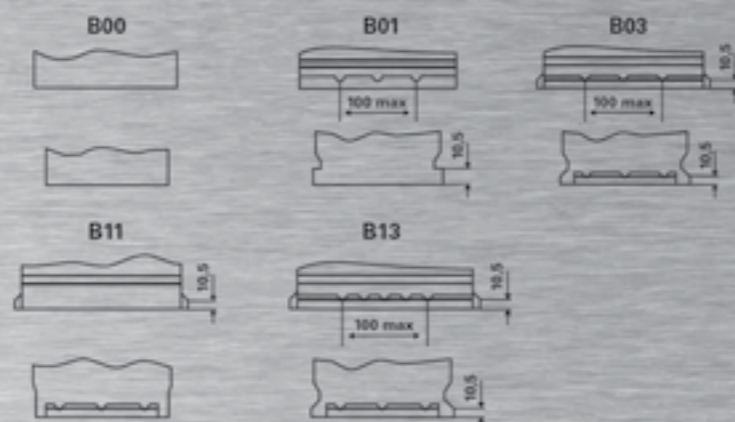

PRIBORI

Slika	Opis	RAPIDEX broj
	Kablovi za startovanje 25 mm ² x 3,5 m	ELEK0554
	Kablovi za startovanje 35 mm ² x 4,5 m	ELEK0703
	Kablovi za startovanje 50 mm ² x 7 m	ELEK0704
	Kontakt klešta 25 - 50 mm ²	ELEK0705
	Klemna +	ELEK0640
	Klemna -	ELEK0600
	Merač kiseline	ELEK0706

ProAtomic akumulatori

Snaga atoma.



- Optimalno prilagođena snaga za starija i novija vozila.
- Bez dodatnog održavanja.
- Izuzetno prihvatljiva cena.
- Paleta putničkih i teretnih akumulatora.
- 30 meseci garancije.

ProAtomic
BY JOHNSON CONTROLS

AKUMULATORI

Oznaka ETN	Skraćenica	Kapacitet	Struja pri hladnom stanju	Dužina (mm)	Širina (mm)	Visina (mm)	Sistem vezivanja	Priključni polovi	Podna prirubnica	RAPIDEX broj
535119030	L35	35	300	187	127	227	1	3	B00	OPRE0252
540406034	D40	40	340	175	175	190	0	1	B13	OPRE0253
545412040	D45	45	400	207	175	190	0	1	B13	OPRE0254
545413040	L45	45	400	207	175	190	1	1	B13	OPRE0091
556400048	D56	56	480	242	175	190	0	1	B13	OPRE0255
556401048	L56	56	480	242	175	190	1	1	B13	OPRE0237
560408054	D60	60	540	242	175	190	0	1	B13	OPRE0256
560127054	L60	60	540	242	175	190	1	1	B13	OPRE0257
574012068	D74	74	680	278	175	190	0	1	B13	OPRE0258
583400072	D83	83	720	353	175	175	0	1	B13	OPRE0259
595402080	D95	95	800	353	175	190	0	1	B01	OPRE0201
610013076	L110	110	760	514	175	210	3	1	B00	OPRE0159
640135076	L140	140	950	513	189	223	3	1	B00	OPRE0187
670043100	L170	170	1000	513	223	223	3	1	B00	OPRE0156
720025145	L220	225	1450	518	291	242	3	1	B01	OPRE0235

Sistem vezivanja

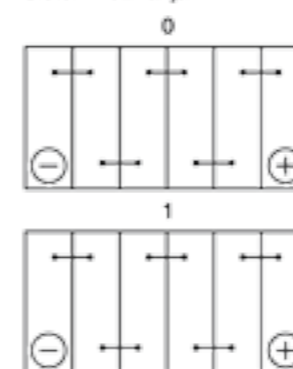

Priključni polovi

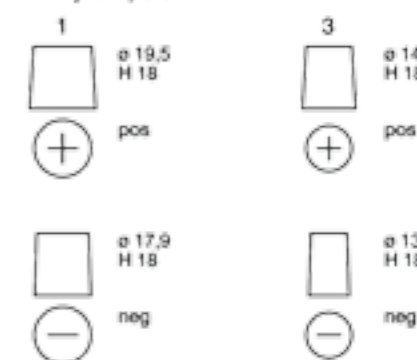

Podna prirubnica

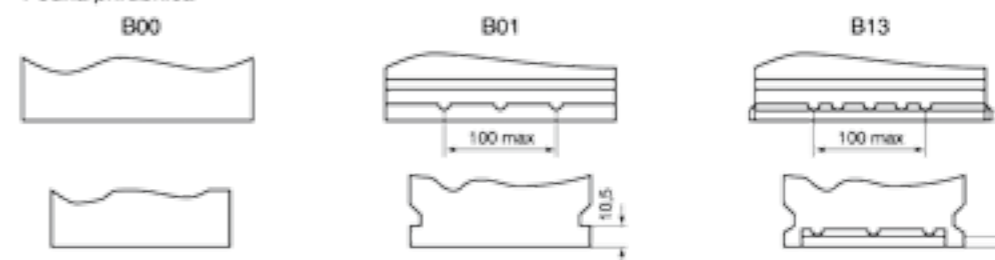

TGL, TGM				
Slika	Opis	KBP	OE broj	RAPIDEX broj
	24 V 4 kW 11 Z	0 001 231 023	51.26201.7222	ELEK0731

TGL, TGM				
Slika	Opis	KBP	OE broj	RAPIDEX broj
	24 V 4 kW 10 Z	0 001 231 035	51.26201.7223	ELEK0732

F90, F2000, TGA (D2866, D2876)				
Slika	Opis	KBP	OE broj	RAPIDEX broj
	24 V 5,4 kW 9 Z	0 001 416 079	51.26201.7181	ELEK0392

F90, F2000, TGA (D2866, D2876)				
Slika	Opis	KBP	OE broj	RAPIDEX broj
	24 V 6,6 kW 9 Z	0 001 417 001	51.26201.7110	ELEK0782

TGA, TGS, TGX (D2066, D2676)				
Slika	Opis	KBP	OE broj	RAPIDEX broj
	24 V 5,5 kW 12 Z	M009T61971	51.26201.7220	ELEK0772



L2000, M2000, F90, F2000				
Slika	Opis	KBP	OE broj	RAPIDEX broj
	28V 55A	0 120 469 686	51.26101.7185	ELEK0707

L2000, M2000, F90, F2000, TGA				
Slika	Opis	KBP	OE broj	RAPIDEX broj
	28V 55A	0 123 325 500	51.26101.7231	ELEK0708

L2000, M2000, F90, F2000				
Slika	Opis	KBP	OE broj	RAPIDEX broj
	28V 80A	0 120 468 107	51.26101.7192	ELEK0710

TGM, TGS, TGA				
Slika	Opis	KBP	OE broj	RAPIDEX broj
	28V 80A	0 124 555 013	51.26101.7271	ELEK1963

L2000, M2000, F2000, TGA				
Slika	Opis	KBP	OE broj	RAPIDEX broj
	28V 100A	0 123 525 501	51.26101.7232	ELEK0717

TGL, TGS, TGA, TGX				
Slika	Opis	KBP	OE broj	RAPIDEX broj
	28V 110A	0 124 655 011	51.26101.7253	ELEK1540
	28V 120A	0 986 049 820	51.26101.7278	ELEK1493

8.0 PRIBORI



8.0 PRIBORI

8.1	Obeležavajuće table i pribori A.D.R.	232
8.2	Oprema	247
8.3	Pribor za osiguravanje tereta	250
8.4	Lanci za sneg	252
8.5	Vučne kuke	254
8.6	Grejanje kabine	257

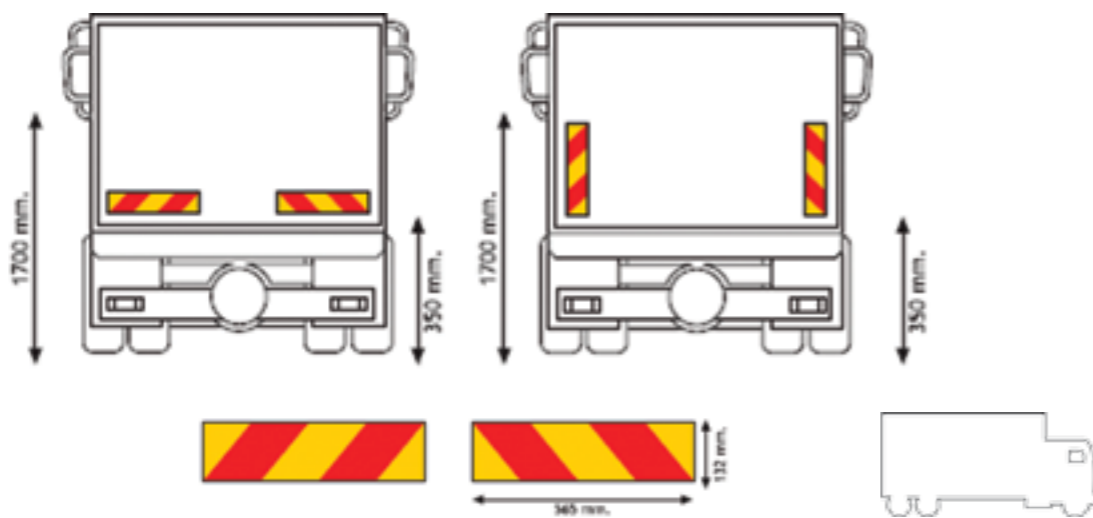
**REFLEKTUJUĆE I FLUOROSCENTNE TABLE ZA KAMIONE
SAGLASNO REGULATIVI ECE 70**

Poz.	Dimenzije (mm)	Opis	Jedinica mere	RAPIDEX broj
1.	565 x 132	Aluminijum	PAR	OPRE097

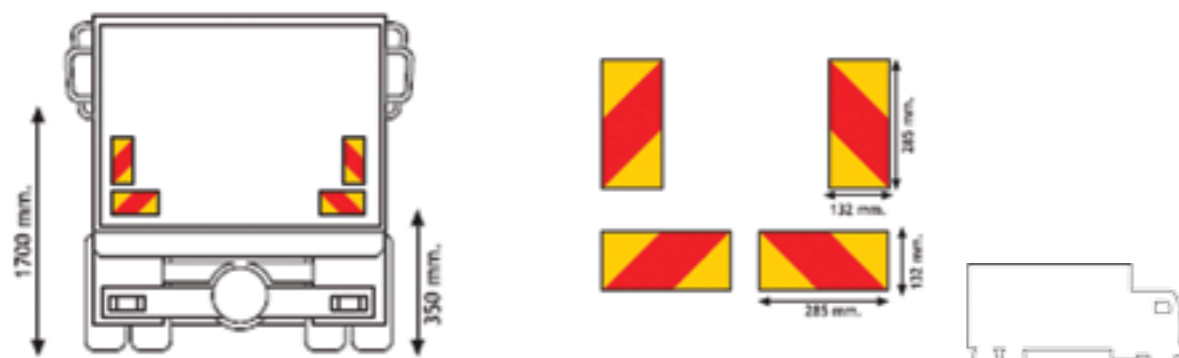

Poz.	Dimenzije (mm)	Opis	Jedinica mere	RAPIDEX broj
2.	285 x 132	Aluminijum	PAR	OPRE0260

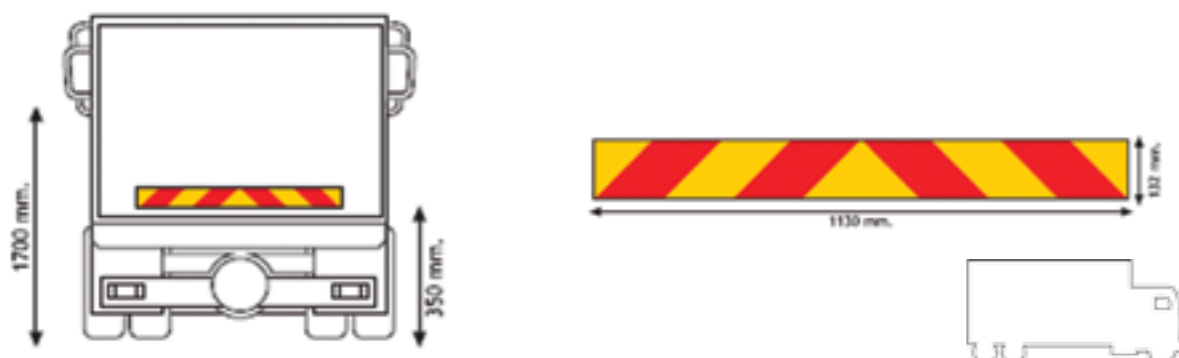

Poz.	Dimenzije (mm)	Opis	Jedinica mere	RAPIDEX broj
3.	1130 x 132	Aluminijum	KOM	OPRE0261

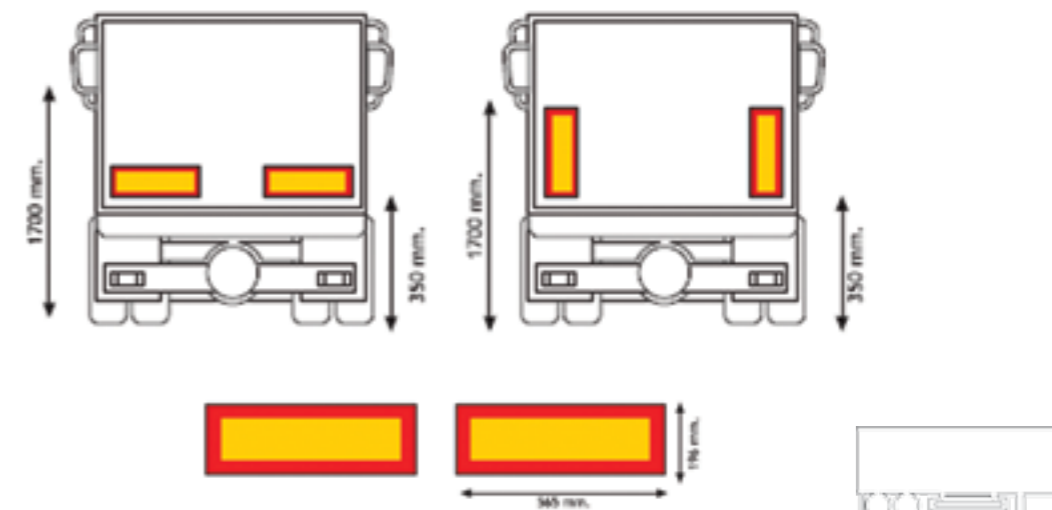
**REFLEKTUJUĆE I FLUOROSCENTNE TABLE ZA KAMIONE
SAGLASNO REGULATIVI ECE 70**

Poz.	Dimenzije (mm)	Opis	Jedinica mere	RAPIDEX broj
1.	565 x 196	Aluminijum	PAR	OPRE0157

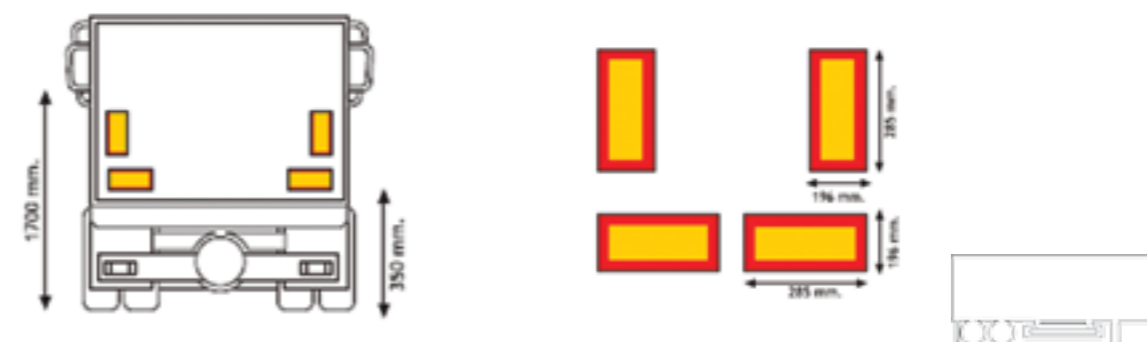

Poz.	Dimenzije (mm)	Opis	Jedinica mere	RAPIDEX broj
2.	285 x 196	Aluminijum	PAR	OPRE0262

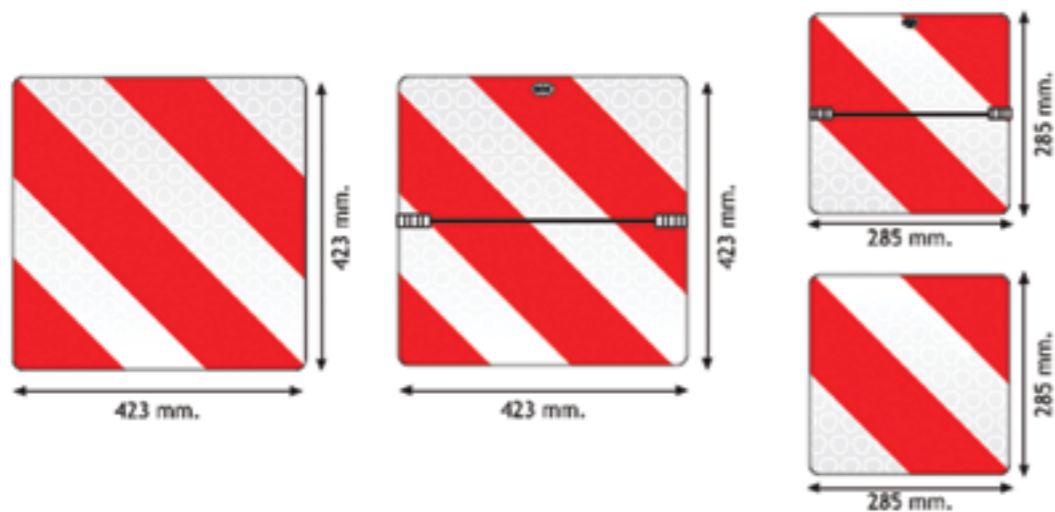

Poz.	Dimenzije (mm)	Opis	Jedinica mere	RAPIDEX broj
3.	1130 x 196	Aluminijum	KOM	OPRE0090

**REFLEKTUJUĆE TABLE ZA PREVOZ TERETA
VAN DOZVOLJENIH GABARITA**

Poz.	Dimenzije (mm)	Opis	Jedinica mere	RAPIDEX broj
1.	423 x 423	Aluminijum / Panel	kom	OPRE0142
2.	423 x 423	Aluminijum / Preklopiva	kom	OPRE0263
3.	285 x 285	Aluminijum / Preklopiva	kom	OPRE0265
4.	285 x 285	Aluminijum / Panel	kom	OPRE0264

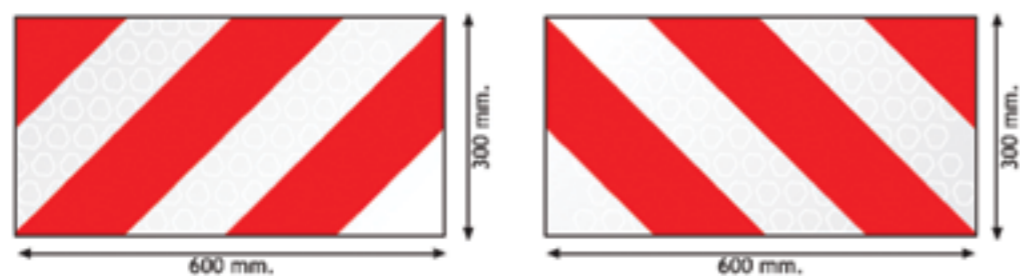

Poz.	Dimenzije (mm)	Opis	Jedinica mere	RAPIDEX broj
5.	600 x 300	Aluminijum / Panel	set	OPRE0266

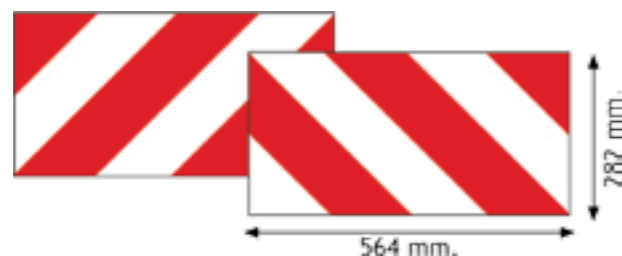

Poz.	Dimenzije (mm)	Opis	Jedinica mere	RAPIDEX broj
6.	564 x 282	Aluminijum / Panel	set	OPRE0267

REFLEKTUJUĆE TABLE OGRANIČENJA BRZINE

Poz.	Dimenzije (mm)	Opis	RAPIDEX broj
1.	Ø 200	Nalepnica	OPRE0268
		Aluminijum	OPRE0269
2.	Ø 200	Nalepnica	OPRE0270
		Aluminijum	OPRE0271
3.	Ø 200	Nalepnica	OPRE0272
		Aluminijum	OPRE0273
4.	Ø 200	Nalepnica	OPRE0274
		Aluminijum	OPRE0275
5.	Ø 200	Nalepnica	OPRE0276
		Aluminijum	OPRE0277
6.	Ø 200	Nalepnica	OPRE0278
		Aluminijum	OPRE0279

OZNAČAVAJUĆE TABLE ZA PREVOZ DECE

Poz.	Dimenzije (mm)	Opis	RAPIDEX broj
1.	400 x 400	Aluminijum	OPRE0280
2.	400 x 400	Aluminijum / Preklopiva - Horizontalno	OPRE0089
3.	400 x 400	Nalepnica	OPRE0282

IDENTIFIKACIONE OZNAKE VOZILA

Poz.	Dimenzije (mm)	Opis	RAPIDEX broj
1.	Ø 200	Aluminijum	OPRE0283
2.	Ø 200	Aluminijum	OPRE0284
3.	Ø 200	Aluminijum	OPRE0285
4.	Ø 200	Aluminijum	OPRE0286
5.	Ø 200	Aluminijum	OPRE0055
6.	Ø 200	Aluminijum	OPRE0056
7.	Ø 200	Aluminijum	OPRE0057



Poz.	Dimenzije (mm)	Opis	RAPIDEX broj
1.	Ø 200	Aluminijum	OPRE0287
2.	Ø 200	Aluminijum	OPRE0288
3.	Ø 200	Aluminijum	OPRE0289



Poz.	Dimenzije (mm)	Opis	RAPIDEX broj
1.	400 x 250	Aluminijum	OPRE0290
2.	400 x 250	Aluminijum / Preklopiva - Horizontalno	OPRE0154
3.	400 x 250	Aluminijum / Preklopiva - Vertikalno	OPRE0291

UPOZORAVAJUĆE TABLE HIDRAULIČNIH ZADNJIH VRATA

Poz.	Opis	RAPIDEX broj
1.	Aluminijumska tabla / desna strana	OPRE0292
2.	Aluminijumska tabla / leva strana	OPRE0293
3.	Aluminijumska tabla sa nosačem / desna strana	OPRE0294
4.	Aluminijumska tabla sa nosačem / leva strana	OPRE0295
5.	Aluminijumske table sa nosačima / desna i leva strana - set	OPRE0296

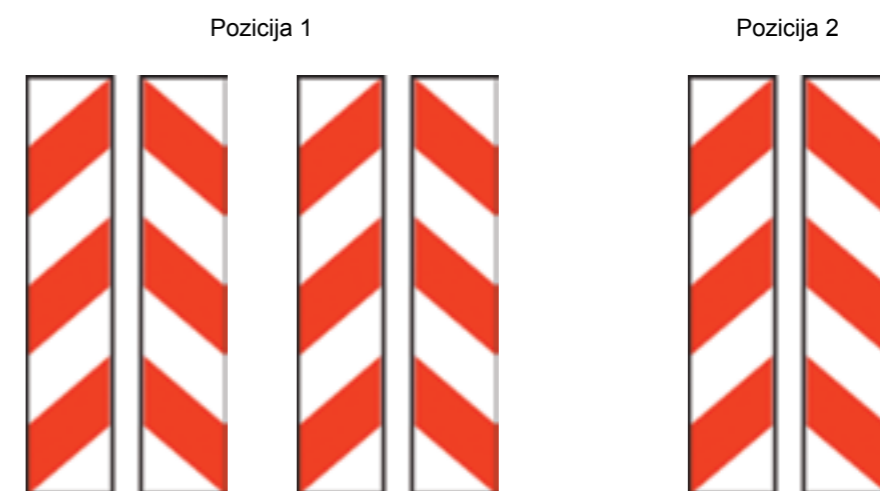
**IDENTIFIKACIONE TABLE ZA VOZILA I KONTEJNERE
SAGLASNO REGULATIVI DIN 67520**

Poz.	Dimenzije (mm)	Opis	RAPIDEX broj
1.	141 x 705	Aluminijum / SET (4 desne + 4 leve table)	OPRE0297
2.	141 x 705	Aluminijum / SET (1 desne + 1 leve table)	OPRE0298

REFLEKTUJUĆE TRAKE ZA VOZILA
SAGLASNO REGULATIVI EEC U.N.104

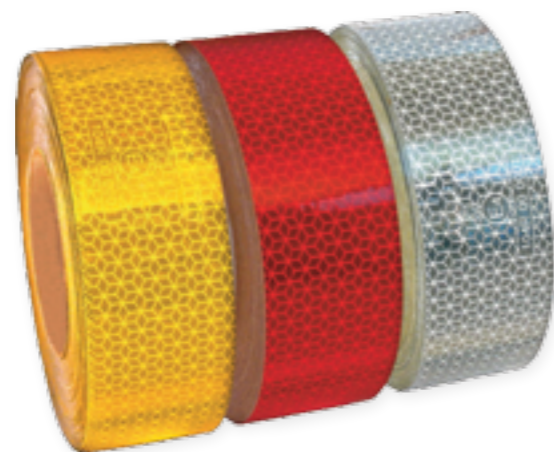

Poz.	Opis	RAPIDEX broj
1.	Reflektujuća traka žute boje 50 mm x 50 m	OPRE0299
2.	Reflektujuća traka crvene boje 50 mm x 50 m	OPRE0300
3.	Reflektujuća traka bele boje 50 mm x 50 m	OPRE0301

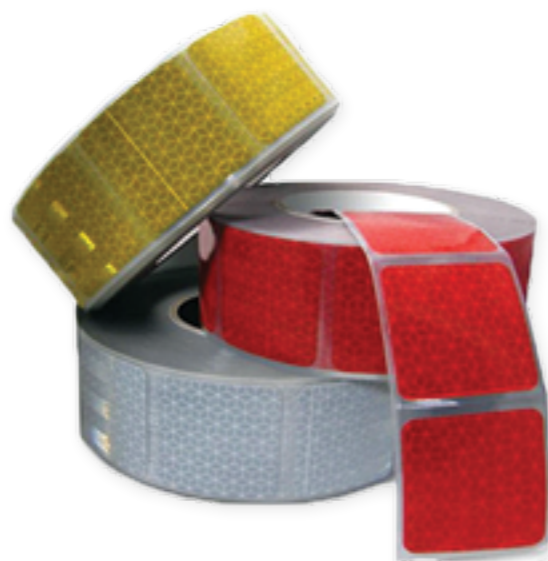

Poz.	Opis	RAPIDEX broj
1.	Reflektujuća traka žute boje 50 mm x 50 m	OPRE0815
2.	Reflektujuća traka crvene boje 50 mm x 50 m	OPRE0817
3.	Reflektujuća traka bele boje 50 mm x 50 m	OPRE0816

REFLEKTUJUĆE TRAKE ZA VOZILA
SAGLASNO REGULATIVI EEC U.N.104

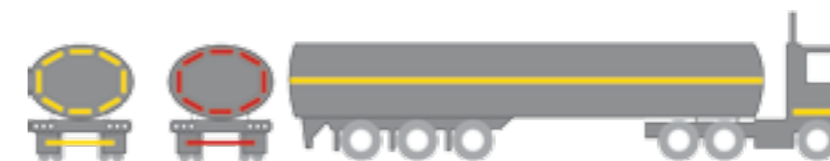
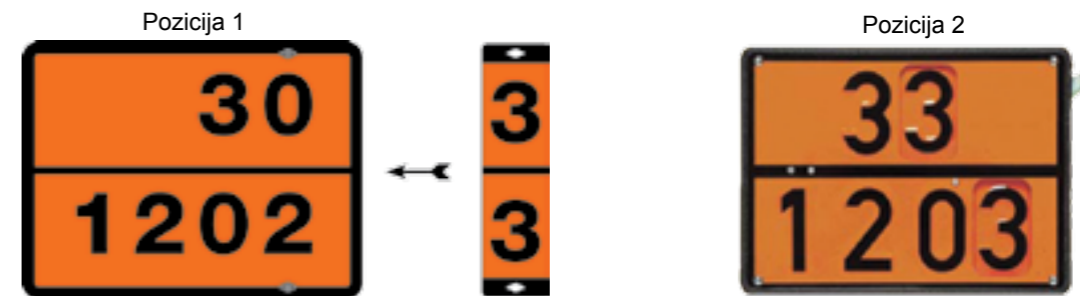

TABLE A.D.R.



Poz.	Dimenzije (mm)	Opis	RAPIDEX broj
1.	400 x 300	Aluminijum	OPRE0153
2.	400 x 300	Aluminijum / Preklopiva - Vertikalno	OPRE0152
3.	400 x 300	Aluminijum / Preklopiva - Horizontalno	OPRE0302



Poz.	Dimenzije (mm)	Opis	RAPIDEX broj
1.	400 x 300	30 - 1202 - Dizel	OPRE0035
2.	400 x 300	33 - 1203 - Benzin	OPRE0036
3.	400 x 300	30 - 1223 - Kerozin	OPRE0037
4.	400 x 300	23 - 1965 - LPG	OPRE0038
5.	400 x 300	23 - 1978 - Propan	OPRE0039
6.	400 x 300	23 - 1971 - Prirodni gas	OPRE0040
7.	400 x 300	23 - 1951 - Tečni argon	OPRE0041
8.	400 x 300	22 - 1977 - Tečni azot	OPRE0042
9.	400 x 300	22 - 2187 - Tečni CO ₂	OPRE0043
10.	400 x 300	223 - 1966 - Tečni vodonik	OPRE0044
11.	400 x 300	225 - 1073 - Tečni kiseonik	OPRE0045
12.	400 x 300	263 - 1040 - Etilenoksid	OPRE0046
13.	400 x 300	23 - 1011 - Butan	OPRE0047
14.	400 x 300	223 - 1038 - Tečni etilen	OPRE0048
15.	400 x 300	223 - 1972 - Tečni prirodni gas	OPRE0049
16.	400 x 300	30 - 1202 - Dizel / Preklopiva - Horizontalno	OPRE0052
17.	400 x 300	33 - 1203 - Benzin / Preklopiva - Horizontalno	OPRE0053
18.	400 x 300	30 - 1202 - Dizel / Preklopiva - Vertikalno	OPRE0303
19.	400 x 300	33 - 1203 - Benzin / Preklopiva - Vertikalno	OPRE0304

TABLE A.D.R.

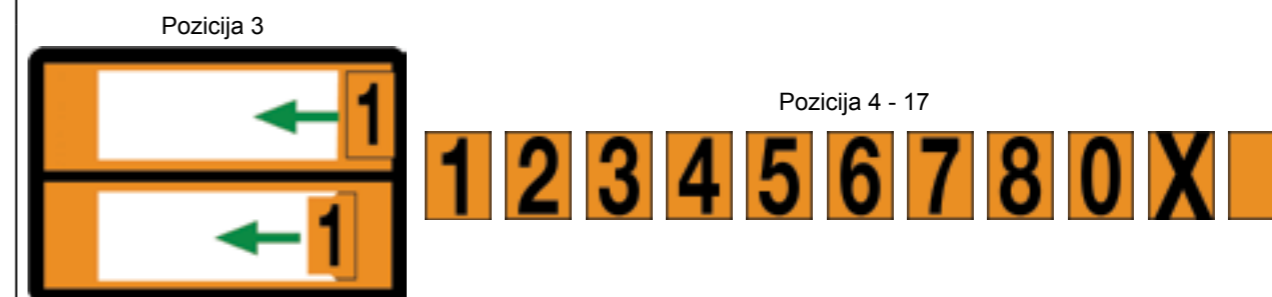
Poz.	Dimenzije (mm)	Opis	RAPIDEX broj
1.	400 x 300	Izmenljiva tabla za dizel i benzin	OPRE0305
2.	400 x 300	Izmenljiva tabla sa ručicom za dizel i benzin	OPRE0054



Poz.	Dimenzije (mm)	Opis	RAPIDEX broj
3.	400 x 300	Tabla(nosač) A.D.R. za različite trasporte	OPRE0034
4.	70 x 118	Set od 10 simbola za tablu A.D.R.: 0 - 2 kom.; 1 - 1 kom.; 2 - 2 kom.; 3 - 3 kom.; Prazno polje - 2 kom.	OPRE0050
5.	70 x 118	Set od 12 simbola za tablu A.D.R.: 1 - 1 kom.; 2 - 1 kom.; 3 - 2 kom.; 5 - 1 kom.; 6 - 3 kom.; 7 - 1 kom.; 8 - 1 kom.; Prazno polje - 2 komada	OPRE0051
6.	70 x 118	Set od 33 simbola za tablu A.D.R.: 0 - 3 kom.; 1 - 3 kom.; 2 - 3 kom.; 3 - 4 kom.; 4 - 2 kom.; 5 - 3 kom.; 6 - 5 kom.; 7 - 2 kom.; 8 - 3 kom.; X - 2 kom.; Prazno polje - 3 komada	OPRE0306
7.	70 x 118	Broj 1 za tablu A.D.R.	OPRE0307
8.	70 x 118	Broj 2 za tablu A.D.R.	OPRE0308
9.	70 x 118	Broj 3 za tablu A.D.R.	OPRE0309
10.	70 x 118	Broj 4 za tablu A.D.R.	OPRE0310
11.	70 x 118	Broj 5 za tablu A.D.R.	OPRE0311
12.	70 x 118	Broj 6 za tablu A.D.R.	OPRE0312
13.	70 x 118	Broj 7 za tablu A.D.R.	OPRE0313
14.	70 x 118	Broj 8 za tablu A.D.R.	OPRE0314
15.	70 x 118	Broj 0 za tablu A.D.R.	OPRE0315
16.	70 x 118	Simbol X za tablu A.D.R.	OPRE0316
17.	70 x 118	Prazno polje za tablu A.D.R.	OPRE0317

TABLE ZA OZNAČAVANJE OPASNIH MATERIJIA 300 x 300 mm

	Klasa 1.1, 1.2, 1.3 RAPIDEX broj: OPRE0318		Klasa 1.4 RAPIDEX broj: OPRE0320		Klasa 1.5 RAPIDEX broj: OPRE0319
	Klasa 1.6 RAPIDEX broj: OPRE0321		Klasa 2 RAPIDEX broj: OPRE0322		Klasa 2 RAPIDEX broj: OPRE0323
	Klasa 2 RAPIDEX broj: OPRE0324		Klasa 3 RAPIDEX broj: OPRE0340		Klasa 4.1 RAPIDEX broj: OPRE0325
	Klasa 4.2 RAPIDEX broj: OPRE0326		Klasa 4.3 RAPIDEX broj: OPRE0327		Klasa 5 RAPIDEX broj: OPRE0328
	Klasa 5.1 RAPIDEX broj: OPRE0329		Klasa 5.2 RAPIDEX broj: OPRE0330		Klasa 6.1 RAPIDEX broj: OPRE0331
	Klasa 6.2 RAPIDEX broj: OPRE0332		Klasa 7/A RAPIDEX broj: OPRE0333		Klasa 7/B RAPIDEX broj: OPRE0334
	Klasa 7/C RAPIDEX broj: OPRE0335		Klasa 7 RAPIDEX broj: OPRE0336		Klasa 8 RAPIDEX broj: OPRE0337
	Klasa 9 RAPIDEX broj: OPRE0338		Klasa 9 RAPIDEX broj: OPRE0339		

TABLE ZA OZNAČAVANJE OPASNIH MATERIJIA

KLASA	OPASNE MATERIJIE
1	Eksplozivne materije i predmeti punjeni eksplozivnim materijama
2	Zbijeni gasovi, gasovi pretvoreni u tečnost i gasovi rastvoreni pod pritiskom
3	Zapaljive tečnosti
4.1	Zapaljive čvrste materije
4.2	Materije sklone samopaljenju
4.3	Materije koje u dodiru sa vodom razvijaju zapaljive gasove
5.1	Oksidirajuće materije
5.2	Organski peroksidi
6.1	Otrovi
6.2	Gadne i zarazne materije
7	Radioaktivne materije
8	Korozivne (nagrizajuće) materije
9	Ostale opasne materije.

KUTIJA ZA PROTIVPOŽARNI APARAT



RAPIDEX broj:
OPRE0886

TEHNIČKE KARAKTERISTIKE:



Spoljašnje mere: 277 x 277 x 635 mm

Unutrašnje mere: 140 ÷ 185 mm

Kapacitet: 6 kg

Ostale karakteristike: vatrootporna, vodootporna i otporna na vibracije

PRIBORI A.D.R.

Slika	Opis	RAPIDEX broj
	Torba A.D.R. Sadrži: PVC rukavice, sredstvo za ispiranje očiju, zaštitne naočare, kompletnu masku, filter zaštitne maske i kecelju	OPRE00315
	Torba A.D.R. Sadrži: PVC rukavice, sredstvo za ispiranje očiju, zaštitne naočare, polumasku, filter zaštitne maske i kecelju	OPRE0070

PRIBORI A.D.R.

Slika	Opis	RAPIDEX broj
	Poklopac za kanalizacioni otvor 1000 x 1000 mm	OPRE0341
	Poklopac za kanalizacioni otvor 2000 x 3000 mm	OPRE0342
	Absorbujući granulat	OPRE0343
	Zaštitno odelo	OPRE0344
	Zaštitna šlem	OPRE0345
	Cipele	OPRE0346

PRIBORI A.D.R.		
Slika	Opis	RAPIDEX broj
	Reflektujući prsluk	OPRE0147
	Trougao upozorenja	OPRE0930
	Čunj	OPRE0347
	Čunj - reflektujući	OPRE0348
	Upozoravajuća lampa	OPRE0349
	Baterijska lampa	OPRE0350
	Preklapajuća lopata	OPRE0128

OPREMA		
Slika	Opis	RAPIDEX broj
	GUMENE ZAVESE 450 x 300 mm	OPRE0549
	GUMENE ZAVESE 650 x 400 mm	OPRE0548
	GUMENE ZAVESE 2400 x 400 mm	OPRE0541
	KLOCNA TOČKA metalna 160 mm	OPRE0359
	KLOCNA TOČKA metalna 200 mm	OPRE0183
	KLOCNA TOČKA plastična 160 mm	OPRE0225
	KLOCNA TOČKA plastična 200 mm	OPRE0912
	NOSAČ ZA KLOCNU 160 mm	OPRE0941
	NOSAČ ZA KLOCNU 200 mm	OPRE0947
	KUTIJA ZA ALAT 600 x 450 x 470 mm 700 x 450 x 650 mm 800 x 450 x 470 mm 1000 x 500 x 470 mm	OPRE0813 OPRE0950 OPRE0949 OPRE0948
	DIZALICA 8 t 12 t 16 t 20 t 30 t	OPRE0360 OPRE0361 OPRE0362 OPRE0208 OPRE0364
	RUDA ZA VUČU	OPRE0194
	PRIBOR ZA ČIŠĆENJE KABINE VOZAČA	OPRE0029

ZAŠTITA REZERVOARA OD KRAĐE GORIVA - KOCKON 105

RAPIDEX broj:	OPRE0814	RAPIDEX broj:	OPRE0803

ZAŠTITA REZERVOARA OD KRAĐE GORIVA - KOCKON 105 I ČEP

RAPIDEX broj:	OPRE0804	RAPIDEX broj:	OPRE0830

ČEP ZIPPER 105

RAPIDEX broj:	OPRE0808

ZAŠTITA REZERVOARA OD KRAĐE GORIVA - TERMOKING

RAPIDEX broj:	OPRE0819	RAPIDEX broj:	OPRE0820

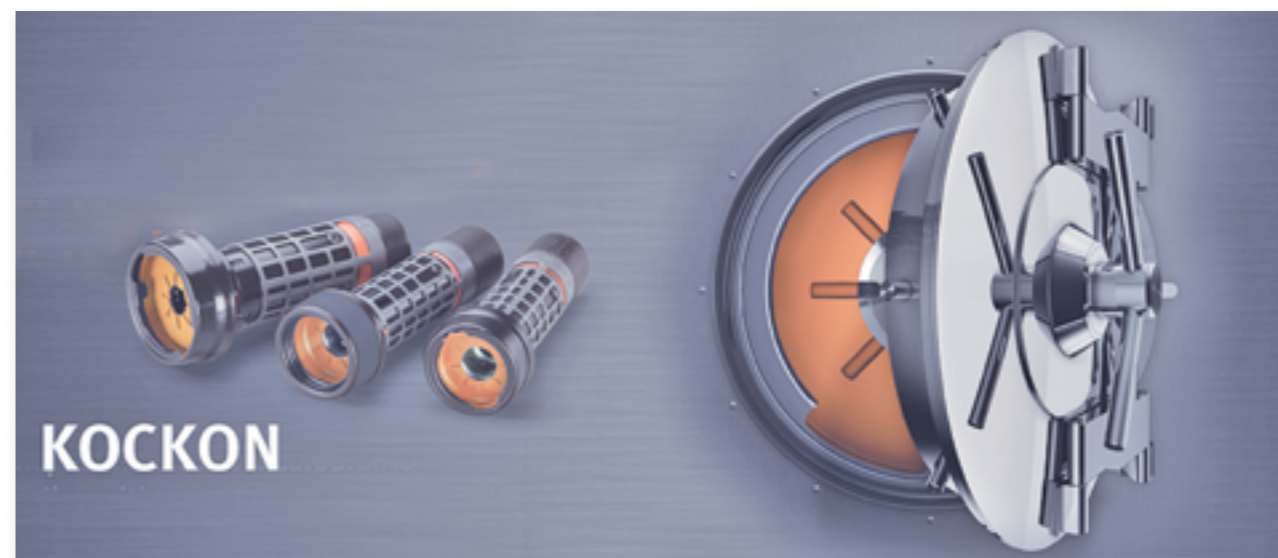

PRIBOR ZA OSIGURAVANJE TERETA

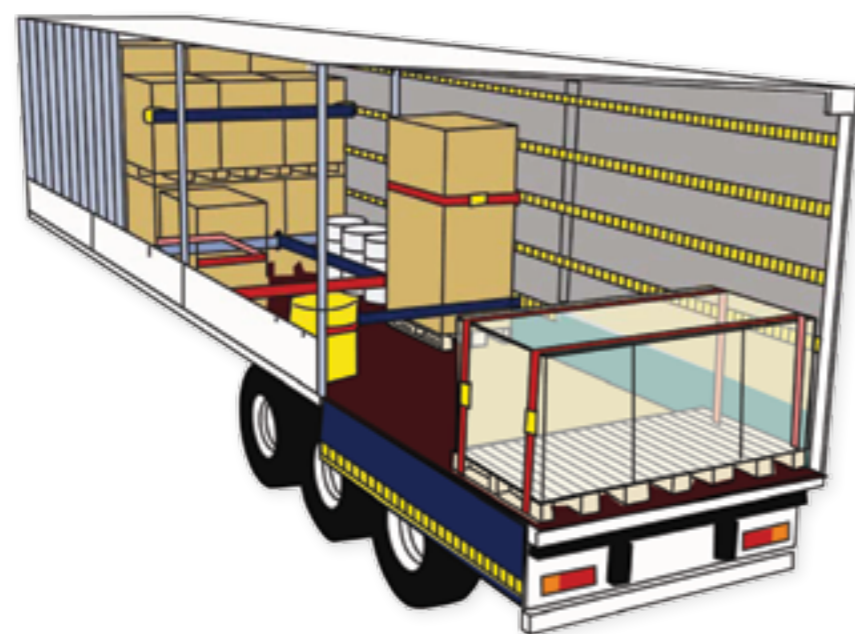
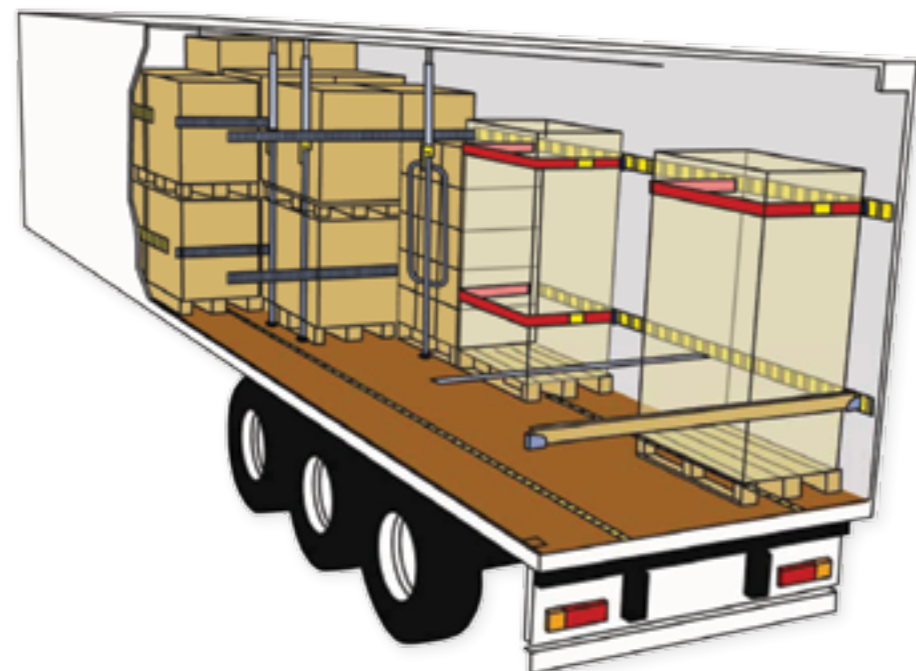

PRIBOR ZA OSIGURAVANJE TERETA



Poz.	Naziv	Dimenzije	Nosivost (daN)		RAPIDEX broj
1.	Traka za vezivanje tereta KPL	8 m x 50 mm	2500	5000	OPRE0185
2.	Traka za vezivanje tereta KPL	10 m x 50 mm	2500	5000	OPRE0184
3.	Traka za vezivanje tereta KPL	12 m x 50 mm	2500	5000	OPRE0170
4.	Traka za vezivanje tereta KPL Duga ručka	8 m x 50 mm	2500	5000	OPRE0780
5.	Traka za vezivanje tereta KPL Duga ručka	10 m x 50 mm	2500	5000	OPRE0779
6.	Traka za vezivanje tereta	10 m x 50 mm	2500	5000	OPRE001
7.	Štitnik robe	180 x 140 x 150 mm			OPRE0939



Poz.	Naziv	Dimenzije		RAPIDEX broj
1.	Letva ADR - aluminijum	21 - 36 mm	2400 - 2700 mm	OPRE0132



Poz.	Naziv	Dimenzije		RAPIDEX broj
1.	Držać - aluminijum	Ø42 mm	2100 - 2470 mm	OPRE0353
2.	Držać - aluminijum	Ø38 mm	2260 - 2630 mm	OPRE0133
3.	Držać - aluminijum	Ø42 mm	2350 - 2720 mm	OPRE0134
4.	Držać - aluminijum	Ø42 mm	2575 - 2965 mm	OPRE0700

8.4 LANCI ZA SNEG

JEDNODELNI LANCI ZA SNEG

Poz.	Primena	RAPIDEX broj
1.	295/60 R22,5	OPRE0954
2.	315/60 R22,5	OPRE0953
3.	315/70 R22,5	OPRE0952
4.	315/80 R22,5	OSTA0198

TRODELNI LANCI ZA SNEG

Poz.	Primena				RAPIDEX broj
1.	205/75 R17,5 215/75 R17,5 225/75 R17,5 235/75 R17,5 7,00 R17,5 8,00 R17,5 8,50 R17,5 9,00 R17,5	7,00 R19,5 8,00 R19,5	6,50 R20		OPRE0357
2.	8,25 R17	245/70 R19,5 265/70 R19,5 275/70 R19,5 285/70 R19,5 9,00 R19,5 9,50 R19,5	7,50 R20 8,25 R20	225/70 R22,5 8,00 R22,5 9,00 R22,5	OPRE0112
3.	305/70 R19,5	9,00 R20	275/70 R22,5 295/70 R22,5 295/60 R22,5 305/60 R22,5 10,00 R22,5	9,50 R24	OPRE0358
4.	10,00 R20 11,00 R20 12,00 R20 12,5 R20 12/80 R20 13/80 R20	11,00 R22	11,00 R22,50 12,00 R22,5 13,00 R22,5 12/80 R22,5 275/80 R22,5 295/80 R22,5 315/80 R22,5 315/75 R22,5 305/70 R22,5 315/70 R22,5 315/60 R22,5	11.2 R24 305/75 R24,5 315/75 R24,5	OPRE0108

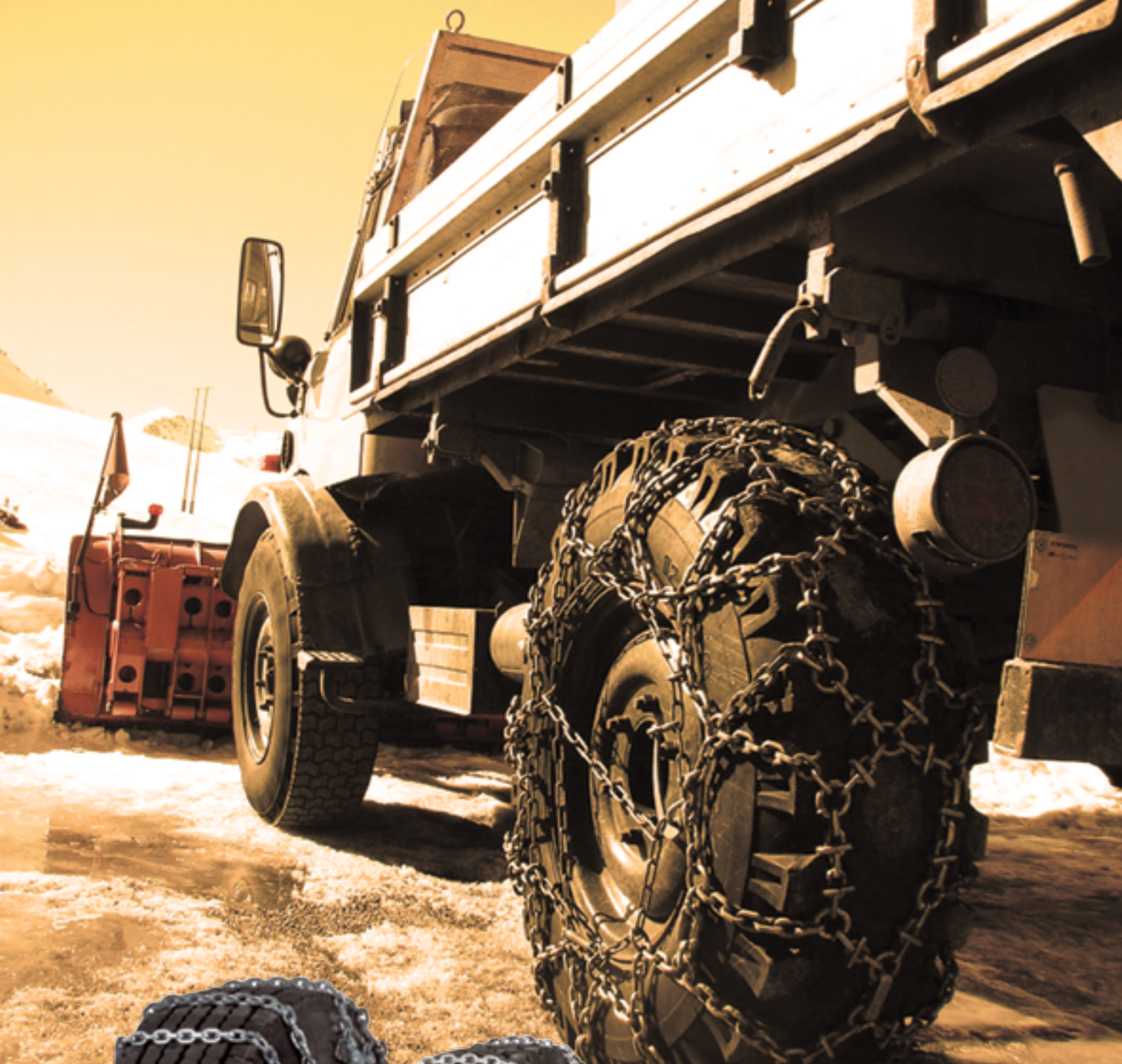

VUČNA KUKA AUTOMATSKA TIP 5055 A, DIN 74053, ISO 1102. D-50

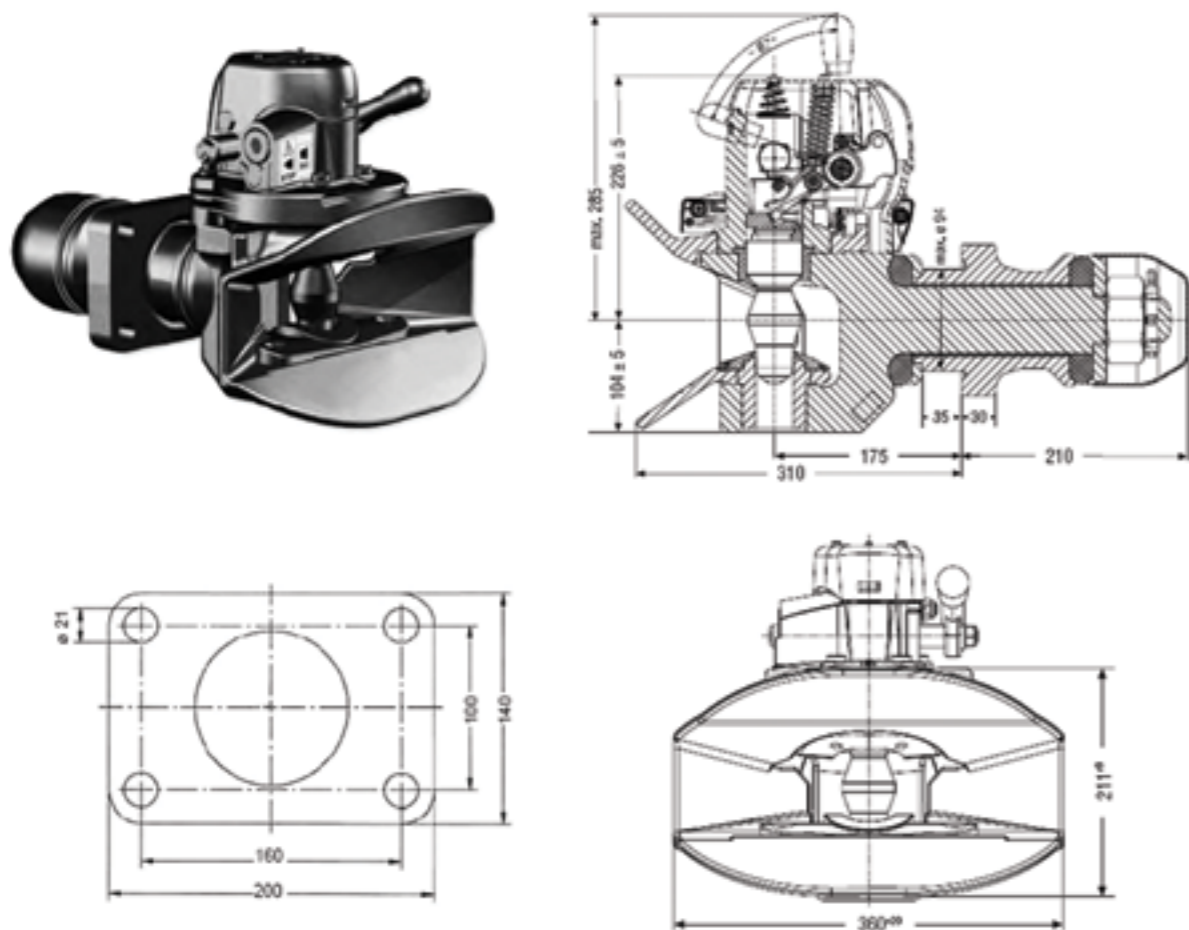

Tehničke karakteristike	Naziv	KBP	RAPIDEX broj
D = 200 kN DC = 135 kN V = 75/63 kN m = 50 kg	VUČNA KUKA	14 996 305	KARO0586
	GORNJA ČAURA	14 995 463	OPRE0237
	DONJA ČAURA	14 991 239	OPRE0236
	STOŽER	14 991 279	OPRE0238
	ZAŠTITNI LIM	14 991 255	OPRE0245

VUČNA KUKA AUTOMATSKA TIP 2045 G/145 G/150, DIN 74054, ISO 8755

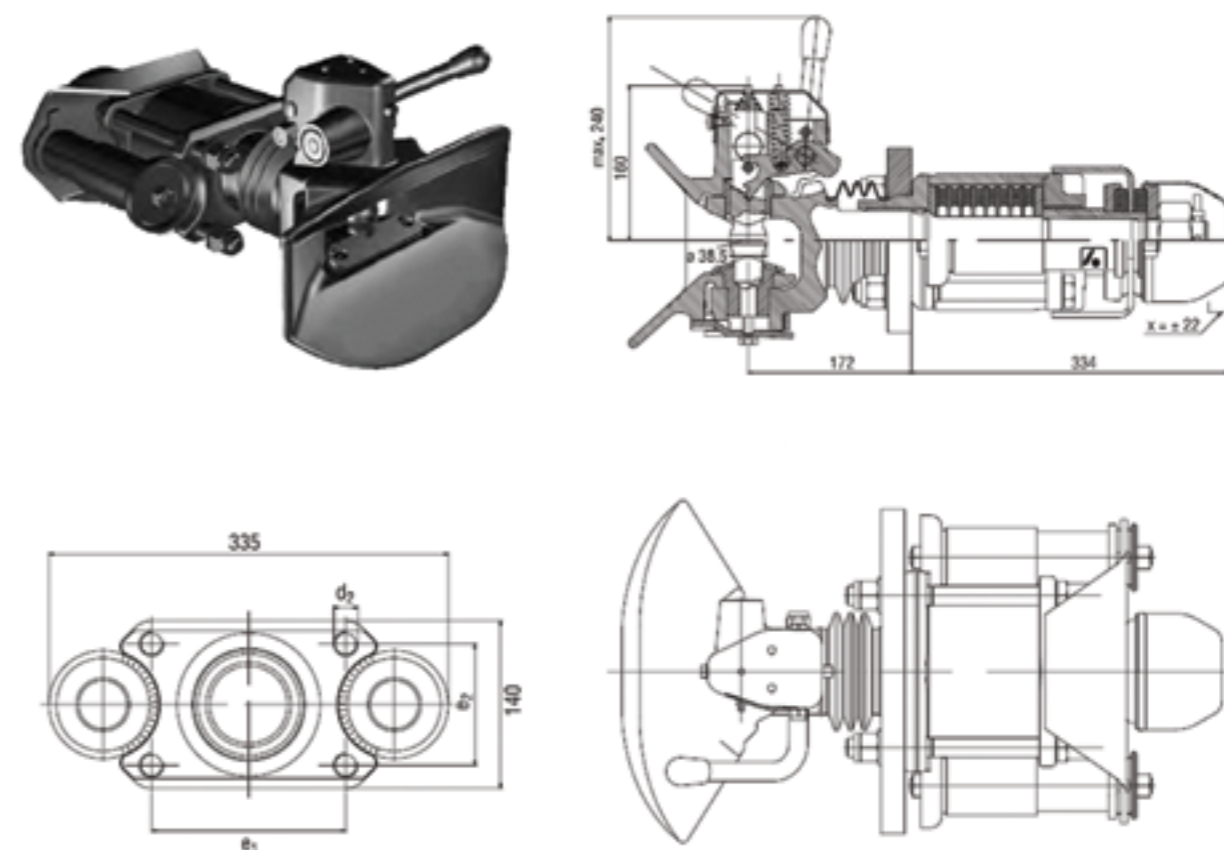

Tehničke karakteristike	Naziv	KBP	RAPIDEX broj
D = 100 kN G/145 D = 136 kN G/136 E1-G/145-140, G/150-160 E2-G/145-80, G/150-100	VUČNA KUKA	G/145 14 995 435	KARO0587
		G/150 14 995 447	KARO0651
	GORNJA ČAURA	6 997 899	OPRE0241
	DONJA ČAURA	6 997 880	OPRE0243
	STOŽER	12 991 452	OPRE0239

VUČNA KUKA AUTOMATSKA TIP 92/CX, DIN 74053, ISO 1102 D 50

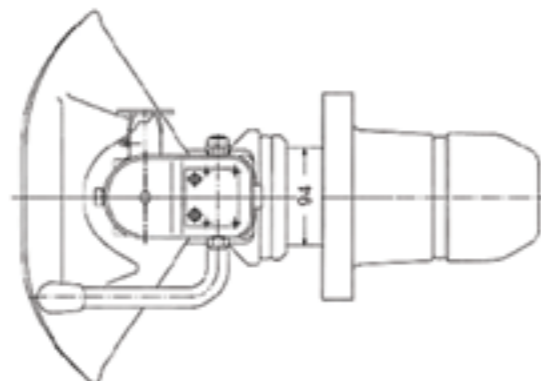
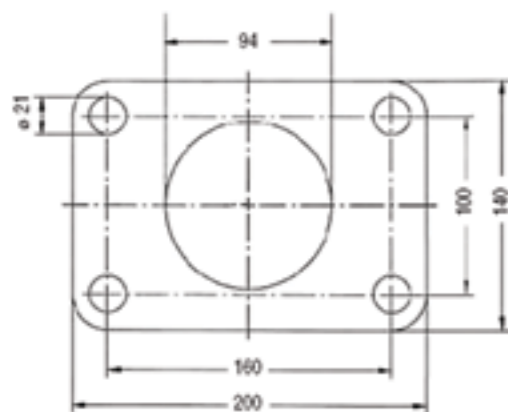
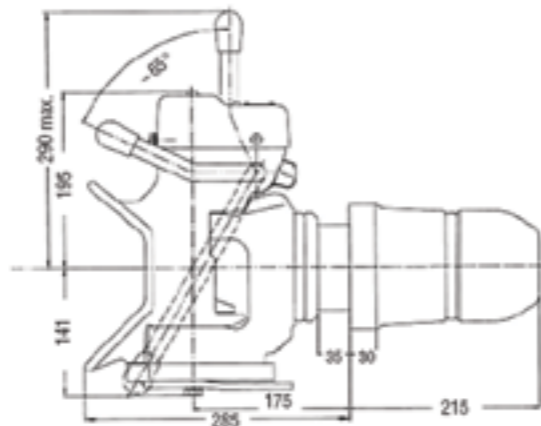

Tehničke karakteristike	Naziv	KBP	RAPIDEX broj
D = 190 kN DC = 130 kN V = 75 kN m = 50 kg	VUČNA KUKA	13 997 020	KARO0588
	GORNJA ČAURA	7 998 210	OPRE0242
	DONJA ČAURA	7 998 252	OPRE0244
	STOŽER	13 991 460	OPRE0240

AIR TOP 2000 ST



RAPIDEX broj:
HLAĐ0182

Napon (V)	Snaga (KW)	Potrošnja goriva (l/h)	Potrošnja energije (W)	Dimenzije (mm)	Težina uređaja (kg)
24	0,9 - 2,0	0,12 - 0,24	14 - 29	311 x 120 x 121	2,6

REZERVNI DELOVI - AIR TOP 2000 / 2000S / 2000ST

Poz.	Slika	Naziv / Opis	KBP	RAPIDEX broj
1.		GORIONIK AT 2000	65786A	HLAĐ0146
2.		MOTOR GREJČA AT 2000 / S	70678A	KABI0004
3.		SVEĆICA-GREJAČ AT 2000 / S	82307A	KABI0003
4.		SENZOR PLAMENA AT 2000	82306C	HLAĐ0178
5.		ZAPTIVKA AT 2000 / S / ST	1303517A	HLAĐ0751

REZERVNI DELOVI - AIR TOP 2000 / 2000S / 2000ST				
Poz.	Slika	Naziv / Opis	KBP	RAPIDEX broj
6.		PUMPA GORIVA AT 2000	65210A	ELEK0505
7.		ELEKTRONIKA AT 2000	87453B	KABI1458
8.		GORIONIK AT 2000 ST	1302799	HLAĐ0656
9.		MOTOR GREJAČA AT 2000 ST N.TIP	1302788	HLAĐ0752
10.		MOTOR GREJAČA AT 2000 ST S.TIP	1303848A	ELEK1716
11.		SVEĆICA-GREJAČ AT 2000 ST	9005087A	HLAĐ0753

AIR TOP 3500 ST					
					RAPIDEX broj: HLAĐ0861
Napon (V)	Snaga (KW)	Potrošnja goriva (l/h)	Potrošnja energije (W)	Dimenzije (mm)	Težina uređaja (kg)
24	1,5 - 3,5	0,18 - 0,42	15 - 33	428 x 148 x 162	5,9

REZERVNI DELOVI - AIR TOP 3500 ST				
Poz.	Slika	Naziv / Opis	KBP	RAPIDEX broj
1.		GORIONIK AT 3500 ST	9004220A	KABI1451
2.		MOTOR GREJAČA AT 3500 ST	9005916A	HLAĐ0754
3.		SVEĆICA-GREJAČ AT 3500 ST	9004215	HLAĐ0755

AIRTRONIC D2

RAPIDEX broj:
HLAD0185

Kapacitet grejanja	W	2200	1800	1200	850
Protok toplog vazduha	kg/h	105	90	60	40
Potrošnja energije	W	34	22	12	8
Potrošnja goriva	l/h	0,28	0,23	0,15	0,1
Dimenzije uređaja	mm	310 x 115 x 122			
Težina uređaja	kg	2,7			

REZERVNI DELOVI - AIRTRONIC D2

Poz.	Slika	Naziv / Opis	KBP	RAPIDEX broj
1.		GORIONIK	252069100100	KABI1459
2.		ZAPTIVKA GORIONIKA	252069060001	KABI1465
3.		MOTOR GREJAČA	252070992000	KABI1460
4.		ZAPTIVKA MOTORA GREJAČA	252069010003	KABI1456

REZERVNI DELOVI - AIRTRONIC D2

Poz.	Slika	Naziv / Opis	KBP	RAPIDEX broj
5.		GREJAČ-SVEČICA	252070010300	KABI1464
6.		SITO SVEČICE KPL	252069100102	KABI1452
7.		SITO SVEČICE	252069100102	KABI1467
8.		PUMPA GORIVA	224518010000	KABI1461

AIRTRONIC D4

RAPIDEX broj:
HLAD0186

Kapacitet grejanja	W	4000	3000	2000	900
Protok toplog vazduha	kg/h	185	140	100	55
Potrošnja energije	W	55	30	16	7
Potrošnja goriva	l/h	0,51	0,38	0,25	0,11
Dimenzije uređaja	mm	376 x 140 x 150			
Težina uređaja	kg	4,5			

REZERVNI DELOVI - AIRTRONIC D4				
Poz.	Slika	Naziv / Opis	KBP	RAPIDEX broj
1.		GORIONIK	252113100100	KABI1462
2.		MOTOR GREJAČA	252114992000	KABI1450
3.		ZAPTIVKA MOTORA GREJAČA	252113010003	KABI1463
4.		GREJAČ-SVEĆICA	252070010300	KABI1464
5.		SITO SVEĆICE KPL	252069100102	KABI1452
6.		SITO SVEĆICE	252069100102	KABI1467
7.		PUMPA GORIVA	224518010000	KABI1461

Komercijalna Vozila

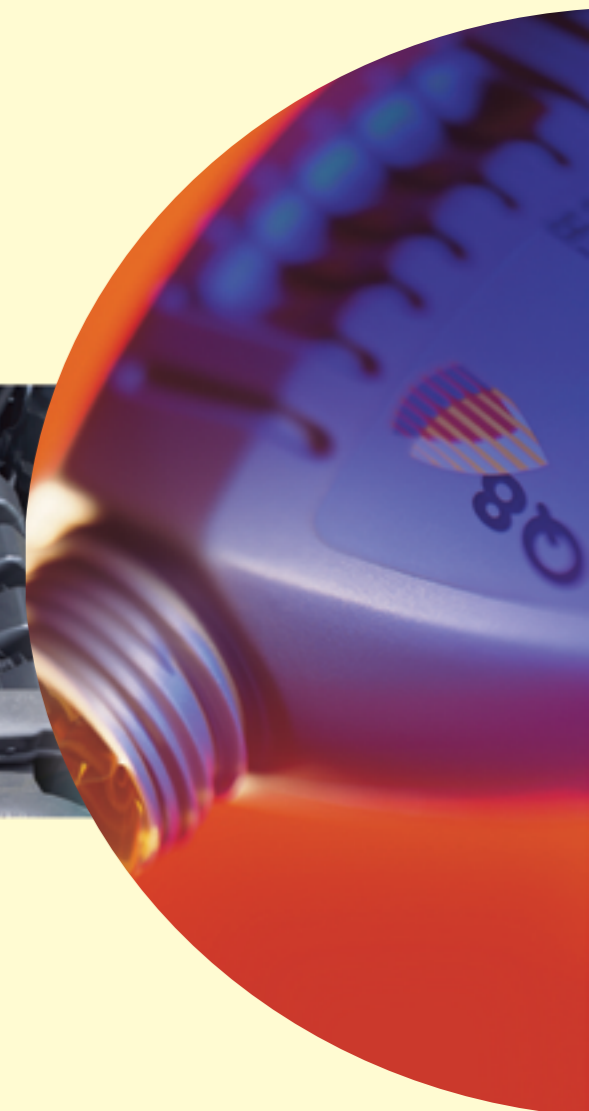

Uvod

Zaštita vašeg motora i ušteda goriva je uvek bila važna uloga Q8 motornih ulja. Zahvaljujući inovacijama, emisija od 25 kamiona danas je jednaka 1 kamionu od pre 30 godina. Da bi se produžio vek ovih motora i vek sistema za prečišćavanje izduvnih gasova, razvili smo novu liniju Q8 Oils maziva za teške dizel motore.

Trendovi

U skladu sa strogim propisima EU o emisiji gasova, svaki moderno dizajnirani kamion sadrži komponente kao što su katalizator, EGR i filtere protiv čađi. Kompanija Q8 Oils razvila je liniju maziva koja ovim komponentama dugoročno obezbeđuje da budu čisti. Time se ujedno smanjuju troškovi održavanja kao i veliki troškovi zamene zagađenih delova; na primer, naknadna ugradnja SCR sistema u proseku košta 7.000,00 EUR.

Naša tehnologija koja je ugrađena u proizvodima Q8 T 904, Q8 T 905, Q8 T 910 i Q8 T 760 obezbeđuje smanjenje vaših troškova održavanja.

Maziva koja obezbeđuju smanjenu potrošnju goriva postala su još privlačnija zato što u najnovijim EURO VI motorima za sve vrste kamiona odobreno je korišćenje ulja sa niskim nivoom gustine, što ujedno predstavlja i za vas priliku da sačuvate novac i garanciju. Maziva koja preporučujemo za smanjenu potrošnju goriva su sledeća: Q8 T 910 5W-30, Q8 T 904 FE 10W-30, Q8 T 760 10W-30 and Q8 SuperTruck FE 5W-30.



Motorna ulja za transportna vozila

Za dugi servisni interval potrebna su ulja visokog kvaliteta, kao što su Q8 T 904 FE ili Q8 T 910.

Rešenje koje pruža kompanija Q8 Oils

U niže navedenoj tabeli prikazani su proizvodi Q8 motorna ulja koja se preporučuju prema vrsti kamiona. SAPS kateorija (Sulphated Ash Phosphorous Sulphur) namenjena za sisteme pročišćavanja izduvnih gasova je specificirana od strane proizvođača kamiona. Izborom Q8 maziva, možete da preferirate između uštede ulja ili periode zamene ulja.

			Ekonomična potrošnja	Osobine pri paljenju hladnog motor	Period zamene ulja						
					DAF	MAN	Mercedes	Volvo	Renault	Iveco	Scania
NISKA VREDNOST PEPELA	Q8 T 904	10W-40	**	**	Long Drain	Long Drain	Long Drain	Medium Drain	Medium Drain	Long Drain (*)	-
	Q8 T 905	10W-40	**	***	Long Drain	Long Drain	Long Drain	Medium Drain	Medium Drain	Long Drain (*)	Medium Drain (**)
	Q8 T 904 FE	10W-30	***	***	Long Drain	Long Drain	Long Drain	Medium Drain	Medium Drain	Long Drain (*)	-
SREDNJA VREDNOST PEPELA	Q8 T 910	5W-30	****	****	Long Drain	Long Drain	Long Drain	Medium Drain	Medium Drain	Long Drain (*)	-
	Q8 T 760	15W-40	*	**	Medium Drain	Medium Drain	Medium Drain	Long Drain	Long Drain	-	Short Drain (***)
	Q8 T 760	10W-30	***	***	Medium Drain	Medium Drain	Medium Drain	Long Drain	Long Drain	-	Short Drain (***)
VISOKA VREDNOST PEPELA	Q8 T 860 S	10W-40	**	***	Long Drain	Long Drain	Long Drain	Long Drain	Long Drain	Long Drain	Long Drain (***)
	Q8 Super Truck FE	5W-30	****	****	Long Drain	Long Drain	Long Drain	Long Drain	Long Drain	Long Drain	Long Drain

(*) od Iveco generacije EURO VI
 (**) EURO VI Scania motori
 (***) Scania motori sa DPF filterom

NISKA VREDNOST PEPELA	Q8 T 910	5W-30	FUEL saver	Dizajnirano za uštedu goriva, mazivo niskog viskoziteta sa odličnim osobinama pri paljenju hladnih motora za skoro sve vrste Euro IV, V i VI dizel motora. Ovo sintetičko ulje sa odličnim performansama i SAPS tehnologijom niske vrednosti razvijeno je specijalno za komercijalna vozila sa dizel filterom za čišćenje čestica (DPF).
	Specifikacije:	ACEA E6/E7; API CI-4		
	Odobrenja:	MAN 3477; MB 228.51; VOLVO VDS-3; RENAULT RLD-2; MACK EO-N		
	Q8 Oils preporuke:	DEUTZ DQC IV-10 LA; MACK EO-M PLUS; MTU TYP-3.1; RENAULT VI RGD/RXD; VOLVO CNG		
NISKA VREDNOST PEPELA	Q8 T 905	10W-40		Sintetičko motorno ulje visokih performansi za teške uslove rada sa niskom vrednošću SAPS-a. Dizajniran je za podmazivanje velikog broja Euro IV, V i VI dizel motora opremljenih sa filterom za čišćenje čestica (DPF) ili katalizatorom (kao SCR) i radi na dizel gorivu sa malo sumpora i pod teškim uslovima. Takođe odgovara i Euro III motorima. Q8 T 905 ima odlična svojstva pri paljenju hladnih motora.
	Specifikacije:	ACEA E6/E7/E9; API CI-4;		
	Odobrenja:	DEUTZ DQC III-10 LA; MACK EO-N; MAN 3477; MB 228.51; MTU TYP-3; RENAULT VI RLD-2; SCANIA Low Ash; VOLVO VDS-3		
	Q8 Oils preporuke:	CUMMINS CES 20076/77; DAF; MACK EO-M PLUS; MB 226.9; MTU TYP 3.1; RENAULT VI RGD, RXD; VOLVO CNG; MAN 3271-1; CATERPILLAR ECF-1a		
NISKA VREDNOST PEPELA	Q8 T 904 FE	10W-30	FUEL saver	Dizajniran za štednju goriva, mazivo niskog viskoziteta za skoro sve Euro IV, V i VI dizel motore. Sintetičko motorno ulje visokih performansi za teške uslove rada sa niskom vrednošću SAPS-a.
	Specifikacije:	ACEA E6,E7; API CI-4		
	Odobrenja:	MAN M3477; MB 228.51; VOLVO VDS-3; RENAULT VI RLD-2; MACK EO-N		
	Q8 Oils preporuke:	DAF; CUMMINS CES 20076/77; DEUTZ DQC III-10 LA		
NISKA VREDNOST PEPELA	Q8 T 904	10W-40		Sintetičko motorno ulje visokih performansi za teške uslove rada sa niskom vrednošću SAPS-a dizajniran je za podmazivanje skoro svih Euro IV, V i VI dizel motora.
	Specifikacije:	ACEA E6 /E7; API CI-4		
	Odobrenja:	MAN M3477; MB 228.51; MTU Type 3.1; RENAULT VI RLD-2; VOLVO VDS-3; MACK EO-N; DEUTZ DQC III-10 LA		
	Q8 Oils preporuke:	DAF; CUMMINS CES 20076/77		
SREDNJA VREDNOST PEPELA	Q8 T 760	15W-40 10W-30	FUEL saver	SHPD (Super High Performance Diesel) dizel motorno ulje sa niskom vrednošću sulfatnog pepela i ograničenom vrednošću fosfora i sumpora, namenjeno za motore koji su u skladu sa Euro V standardom i Američkim EPA 2007 zahtevima za izduvne gasove. Pogodno je za duge intervale zamene ulja i za vozila opremljena sa filterima za čišćenje čestica i katalizatorima (npr. SCR). Q8 T 760 SAE 15W-40 takođe može da se koristi i za Euro II i III dizel motore. Q8 T 760 SAE 10W-30 je ulje koje štedi gorivo, niskog viskoziteta i nije pogodan za starije motore.
	Specifikacije:	ACEA E9; API CJ-4/API SN; CATERPILLAR ECF-1a/ECF-2/ECF-3		
	Odobrenja:	MACK EO-O PREMIUM PLUS; MAN 3575; MB228.31; RENAULT VI RLD-3; VOLVO VDS-4		
	Q8 Oils preporuke:	CUMMINS CES 20081; DDC 93K218; DEUTZ DQC III-10; MAN 3275; MTU TYPE 2.1		
VISOKA VREDNOST PEPELA	Q8 T 860 S	10W-40		Dizel motorno ulje sa izuzetno visokim performansama koje se sastoji od sintetičkih baznih ulja. Razvijeno je motore kompanije Scania koja dozvoljava zamenu ulja na 120.000 km. Na tržištu je dostupno od marta 2013.
	Specifikacije:	ACEA E4/E7; API CF		
	Odobrenja:	SCANIA LDF-3		
	Q8 Oils preporuke:	VOLVO VDS-3; MB 228.5; MAN 3277; RENAULT RLD-2		
VISOKA VREDNOST PEPELA	Q8 SuperTruck FE	5W-30	FUEL saver	Dizajnirano za uštedu goriva, mazivo niskog viskoziteta sa odličnim osobinama pri paljenju hladnih motora za skoro sve vrste Euro III i neke vrste Euro IV i V i dizel motora. Ovo je UHPD (Ultra High Performance Diesel) sintetičko dizel motorno ulje sa izuzetno visokim performansama koje omogućava produženi interval zamene ulja.
	Specifikacije:	ACEA E4/E7		
	Odobrenja:	MAN 3277; MB 228.5;		
	Q8 Oils preporuke:	IVECO; CUMMINS CES 20071/72/76/77; MACK EO-M PLUS; MB 235.28; MTU TYPE-3; SCANIA LDF; VOLVO VDS-3		

VISOKA VREDNOST PEPLJA	Q8 T 860	10W-40	UHPD dizel motorno ulje sa izuzetno visokim performansama na sintetičkoj bazi namenjeno je za skoro sve Euro III i pojedine Euro IV i V dizel motore. ACEA E4 specifikacija garantuje visok nivo čišćenja čadi u motoru.
	Specifikacije:		ACEA E4/E7; API CI-4
	Odobrenja:		CUMMINS CES 20077/78; DEUTZ DQC III-05; MACK EO-M PLUS; MAN 3277; MB 228.5; MTU TYPE-3; SCANIA LDF-2; TEDOM 258-3; VOLVO VDS-3
	Q8 Oils preporuke:		DAF; JASO DH-1; RENAULT VI RXD/RLD-2; VOITH RETARDER KLASSE A
VISOKA VREDNOST PEPLJA	Q8 T 800	10W-40	Polu-sintetičko dizel motorno ulje visokih performansi namenjeno je za Euro III i Euro IV motore sa niskom emisijom izduvnih gasova, koje omogućava i smanjenje potrošnje goriva. Takođe je pogodno za dizel motore putničkih automobila i manje motore sa direktnim ubrizgavanjem.
	Specifikacije:		ACEA E7/B4/A3; API CI-4/SL
	Odobrenja:		MACK EO-N; MAN 3275; RENAULT VI RLD-2; TEDOM 258-3; VOLVO VDS-3, DEUTZ DQC III -10; MTU TYP-2
	Q8 Oils preporuke:		CUMMINS CES 20071/72/76/77/78; MACK EO-M PLUS; MB 228.3; MB 229.1; GLOBAL DHD-1; CATERPILLAR ECF-1/ECF-2
VISOKA VREDNOST PEPLJA	Q8 T 750	15W-40	Q8 T 750 može da se koristi za sve četvorotaktne dizel motore sa gorivom koje ima malu vrednost sumora (<0.05 %) i za motore kamoiona, kao i za motore poljoprivrednih i industrijskih radlića koje rade pod teškim uslovima. Takođe može da se koristi kod benzinskih i dizel motora putničkih automobila.
	Specifikacije:		ACEA E7/B4/A3; API CI-4/SL;
	Odobrenja:		DEUTZ III-10; MACK EO-N PLUS; MAN 3275; VOLVO VDS-3; MB 228.3; MTU TYPE-2; RENAULT VI RLD, RLD-2; ZF TE-ML 04C/07C; CUMMINS 20071/72/76/77
	Q8 Oils preporuke:		MB 229.1; GLOBAL DHD-1; CATERPILLAR ECF-1/ECF-2



Ulja za menjače i osovine kod komercijalnih vozila

Kod savremenih menjača i osovina, od suštinskog značaja su dobra zaštita od trenja i termička stabilnost, da bi se postigao što duži servisni interval. Ulja za menjače imaju i veliki uticaj na potrošnju goriva. Kao na primer Q8 T 60Ntech u menjaču i Q8 T 66 u zadnjoj osovini.

	GL-4	GL-5	mil-prf 2104e	Synth. Base Oil Components	Long Drain	Fuel Economy	Drive Line = Gear Box + Rear Axle	Intarder Suited	DAF	Iveco	MAN	Mercedes	Renault	Scania	Volvo
MENJAC	Q8 Gear Oil XG	✓	✓	-	*	*	✓	-	-	-	✓	-	-	✓	-
	Q8 T60Ntech	-	-	-	**	**	-	✓	✓	✓	✓	-	✓	-	-
	Q8 Supergear S	GL-3	-	-	***	**	**	-	-	-	-	-	-	-	✓
	Q8 T 36	✓	-	-	***	***	*	-	-	-	-	✓	-	-	-
ZADNJA OSOVINA	Q8 Axle Oil XG	✓	✓	✓	-	*	✓	-	✓	✓	-	-	-	✓	-
	Q8 Trans XGS	✓	✓	✓	***	***	**	✓	✓	✓	✓	✓	-	-	-
	Q8 T 65	-	✓	-	***	***	**	-	-	-	-	-	-	-	✓
	Q8 Unigear GL-5	-	✓	-	**	**	**	-	-	-	-	-	-	-	✓
	Q8 T 66	✓	✓	✓	***	***	***	-	✓	✓	✓	✓	-	✓	✓

MENJAC	Q8 Gear Oil XG	80W-90	Q8 Gear Oil XG je automotivno univerzalno menjačko ulje za sinhronizovane i nesinhronizovane manualne menjače, osovine i sve komponente koje prenose snagu (od motora do zadnje osovine) i koje zahtevaju API GL-4/GL-5 nivo performansi. Odobreno je od strane kompanije Scania za servisni interval do 180.000 km.
	Specifikacije: Odobrenja:		API GL-4; API GL-5 SCANIA STO 1:0; SAE J 2360 (PRI GL 0208); MAN 341 E2/Z2, 342 M2; ZF TE-ML 02B/05A/12E
MENJAC	Q8 T 60 Ntech	75W-80	Q8 T 60 Ntech je ulje na sintetičkoj bazi za manualne menjače sa visokim performansama koji zahtevaju specijalne osobine tečnosti na niskim i visokim temperaturama, što rezultuje da se lakše menjaju brzine.
	Odobrenja: Q8 Oils preporuke:		ZF TE ML 02L MAN 341 Z3/E3/Z4; VOLVO 97305; ZF TE-ML 01L
MENJAC	Q8 SuperGear S	75W-80	Q8 SuperGear S je sintetičko ulje sa najnovijom tehnologijom aditiva za manualne menjače. Može se koristiti kao višenamensko ulje za manualne menjače kod kamiona, autobusa i putničkih automobila.
	Specifikacije: Q8 Oils preporuke:		API GL-3; VOLVO 97305 JOHN DEERE JDM J11C; VOLVO 97307
MENJAC	Q8 SuperGear V	75W-80	Q8 SuperGear V je sintetičko ulje razvijeno za Volvo manualne menjače. Može se koristiti kao ulje za manualne menjače u kamionima i autobusima.
	Specifikacije: Odobrenja: Q8 Oils preporuke:		API GL-4 VOLVO 97307 MAN 341 ZE-VR (former MAN 341 SL); VOITH RETARDER OIL CLASS C; EATON S SERIES TRANSMISSIONS
MENJAC	Q8 T 36	75W-90	Q8 T 36 je potpuno sintetičko ulje za "switch gear" menjače sa najvišim performansama koji zahtevaju posebna svojstva tečnosti na visokim i niskim temperaturama i time poboljšavaju prenose. Proizvod je razvijen specijano za komercijalna vozila marke Mercedes.
	Specifikacije: Odobrenja:		API GL-4 MAN 342 TYP MB; MB 235.11
ZADNJA OSOVINA	Q8 Axle Oil XG	80W-140	Automotivno ulje koje je namenjeno za osovine i diferencijale. Odobreno je od strane kompanije Scania za servisni interval do 180.000 km.
	Specifikacije: Odobrenja: Q8 Oils preporuke:		API GL-4/GL-5; MIL-PRF-2105 E SCANIA STO 1:0; ZF TE-ML 05A/12E/16D/21A ZF TE-ML 02B
ZADNJA OSOVINA	Q8 Trans XGS	75W-90	Sintetičko automotivno ulje za zadnje osovine, diferencijale i pojedine manualne menjače koji rade pod teškim uslovima i koji zahtevaju posebne osobine tečnosti pri niskim temperaturama da bi se dobila niža potrošnja goriva i lakša promena brzina.
	Specifikacije: Odobrenja: Q8 Oils preporuke:		API GL-4/GL-5; MIL-PRF-2105-E MAN 341 E3/Z2, 342 M3; SCANIA STO 1:0; ZF TE-ML 02B/5A/12B MAN 342 S1
ZADNJA OSOVINA	Q8 T 65	75W-90	Sintetičko ulje za menjače koje pruža kombinaciju dobrih osobina tečnosti na niskim i visokim temperaturama. Time se smanjuje trenje i samim tim smanjuje se i buka prenosa i potrošnja goriva.
	Specifikacije: Odobrenja: Q8 Oils preporuke:		API GL-5 VOLVO 97312; ZF TE-ML 17B/19B ZF TE-ML 05A
ZADNJA OSOVINA	Q8 Unigear GL-5	75W-90	Automotivno ulje na sintetičkoj bazi namenjeno je za manualne menjačime i osovine u putničkim i komercijalnim vozilima.
	Specifikacije: Q8 Oils preporuke:		API GL-5; MIL-L-2105D ZF TE-ML 05A
ZADNJA OSOVINA	Q8 T 66	75W-110	Razvijen u cilju postizanja značajne uštede goriva za osovine u kamionima koji rade pod velikim opterećenjem. Relativno novi viskozitet SAE 110 se koristi radi postizanja optimalnog podmazivanja. Ovo sintetičko ulje je za podmazivanje visoko opterećenih komponenta, kao što su zadnje osovine, diferencijali i pojedini menjači. Potvrđeno je da Q8 T 66 smanjuje potrošnju goriva do 4,7 %.
	Specifikacije: Q8 Oils preporuke:		API GL-4/GL-5; API MT-1; MIL-PRF-2105E; SAE J 2360 ZF TE-ML-05B/12B; MACK GO-J; MB 235.8; MAN 341 S1; SCANIA STO 1:0



Ulja za automatske menjače u komercijalnim vozilima



Q8 Auto 14

Ulje za automatske menjače koje takođe odgovara za servo volane i kao hidraulično ulje.

Q8 Oils preporuke:

MB 236.7; VME; ZF TE-ML 14A; VOITH 55.6335.3X

Q8 Auto 15 ED

Q8 Auto 15 ED je ulje na sintetičkoj bazi za automatske menjače koje takođe odgovara za servo volane i kao hidraulično ulje.

Q8 Oils preporuke:

VOITH DIWA H55.6336.3X; ZF TE-ML 14B

Hidraulična ulja za komercijalna vozila



Q8 Haydn

10, 15,
22, 32,
46, 68,
100, 150

Univerzalno hidraulično ulje za višenamensku upotrebu sa indeksom viskoziteta vrednosti 100. Bazno ulje ima dobar prirodni otpor starenju (oskidaciji) i ujedno veoma svetlu boju. Ovo se lako filtrira.

Važeći za sledeće primene:

AFNOR 48-603, CATEGORY HM; MAG IAS P-68/P-69/P-70; DENISON HF-0/HF-1/HF-2; DIN 51524 PART 2, CATEGORY HLP; ISO 11158, CATEGORY HM; SS 155434, CATEGORY AM

Q8 Heller

15, 22,
32, 46,
68, 100

Q8 Heller je mineralno hidraulično ulje tipa HVLP sa izuzetno visokim indeksom viskoziteta, vrednosti 150. Q8 Heller je idealno za upotrebu u hidrauličnim sistemima koje rade u uslovima velikih temperaturnih promena. Optimalni viskozitet pri pokretanju u hladnim uslovima obezbeđuje neometani rad hidrauličnih sistema. Koristi se za kopačice i ostale mašine koje rade u spoljnim uslovima. Q8 Heller odgovara zahtevima većine proizvođača džipova.

Važeći za sledeće primene:

AFNOR 48-603, CATEGORY HV; DIN 51524 PART 3, CATEGORY HVLP; ISO 11158, CATEGORY HV

Masti za komercijalna vozila



Q8 Rembrandt EP 2

NLGI 2

Višenamenska litijumska mast unapređena sa aditivima koji poboljšavaju osobine otpornosti pri visokom pritisku i oksidaciji; takođe sadrži i inhibitor rđanja.

Veličina pakovanja:

50kg KEG, 12.5kg, 180kg, 12 x 400g (CART)

Q8 Rembrandt Moly

NLGI 2

Visoko kvalitetna višenamenska litijumska mast koja sadrži molibdenski disulfid koji obezbeđuje dodatnu zaštitu od trenja. Sadrži inhibitor rđanja i additive protiv oksidiranja.

Veličina pakovanja:

50kg KEG, 12.5kg, 180kg, 12 x 400g (CART)

Q8 Rembrandt EP 00 WV

NLGI 00

Litijumska mast za centralne sisteme podmazivanja marke Willy Vogel preporučuje se za upotrebu kada se zahtevaju specifikacije MB 264 i MAN 283. Specijalno za automotivne aplikacije gde je potrebno lako pumapanje pri niskim temperaturama.

Veličina pakovanja:

12.5kg, 50kg KEG, 12.5kg

Q8 Rubens WB Blau

NLGI 2

Višenamenska litijumska kompleksna mast za ležajeve u kamionima i prikolicama gde je potrebno lako pumapanje u centralnim sistemima za podmazivanje a zahteva se NLGI 2 mast.

Veličina pakovanja:

50kg KEG, 12.5kg, 12 x 400g (CART)

Ostali proizvodi



Q8 Brake Fluid DOT 4

Nepetrolejska kočiona tečnost sa osobinom stvaranja niskog parnog pritiska. Pogodna je za korišćenje u hidrauličnim sistemima kočnica i kvačila u svim putničkim automobilima, kamionima, autobusima i prikolicama gde se traže proizvodi visokih performansi. Ovaj proizvod se posebno preporučuje za funkcionisanje pri visokim temperaturama koje se stvara od kočionih diskova ili kada postoji dodatno opterećenje na kočionom sistemu.

Q8 Oils preporuke:

FMVSS 116 DOT 3; FMVSS 116 DOT 4; SAE J1703

Veličina pakovanja:

50kg KEG, 12.5kg, 180kg, 12 x 400g (CART)

Q8 Antifreeze Long Life

Univerzalni koncentrat antifriza visokih performansi koji daje zaštitu tokom cele godine kao rashladna tečnost leti i antifriz zimi. Baziran je na etilen glikolu, hemijski stabilan i ne podleže koroziji.

Q8 Oils preporuke:

BS 6580, 5177; SAE J 1034; ASTM D 3306; FVV Heft R 443; MAN 324 TYPE SNF

Veličina pakovanja:

1L, 5L, 25L, 205L

Q8 Degreasing Fluid HFB

Višenamenski odmašivač koji se ispira vodom.

Veličina pakovanja:

25L, 208L

Q8 Oils

MOTORNO ULJE	Q8 T 905	208 litara	RAPIDEX BROJ - ULJA0171
	Q8 T 905	60 litara	RAPIDEX BROJ - ULJA0129
	Q8 T 905	20 litara	RAPIDEX BROJ - ULJA0130

MOTORNO ULJE	Q8 T 860	208 litara	RAPIDEX BROJ - ULJA0135
	Q8 T 860	60 litara	RAPIDEX BROJ - ULJA0128
	Q8 T 860	20 litara	RAPIDEX BROJ - ULJA0127
	Q8 T 860	5 litara	RAPIDEX BROJ - ULJA0157

MOTORNO ULJE	Q8 T 800	1000 litara	RAPIDEX BROJ - ULJA0185
	Q8 T 800	208 litara	RAPIDEX BROJ - ULJA0158
	Q8 T 800	60 litara	RAPIDEX BROJ - ULJA0193
	Q8 T 800	20 litara	RAPIDEX BROJ - ULJA0159
	Q8 T 800	5 litara	RAPIDEX BROJ - ULJA0160

MOTORNO ULJE	Q8 T 760	208 litara	RAPIDEX BROJ - ULJA0171
	Q8 T 760	20 litara	RAPIDEX BROJ - ULJA0129
	-	-	-

MOTORNO ULJE	Q8 T 750	208 litara	RAPIDEX BROJ - ULJA0136
	Q8 T 750	60 litara	RAPIDEX BROJ - ULJA0146
	Q8 T 750	20 litara	RAPIDEX BROJ - ULJA0145
	Q8 T 750	5 litara	RAPIDEX BROJ - ULJA0194

MOTORNO ULJE	Q8 T 520	208 litara	RAPIDEX BROJ - ULJA0161
	Q8 T 520	20 litara	RAPIDEX BROJ - ULJA0162
	-	-	-

ANTIFRIZ	G12 + KONCENTRAT	208 litara	RAPIDEX BROJ - HLA00648
	G12 + KONCENTRAT	20 litara	RAPIDEX BROJ - HLA00647
	-	-	-

MAST	Q8 REMBRANT EP2	192 kilograma	RAPIDEX BROJ - ULJA0246
	Q8 REMBRANT EP2	18 kilograma	RAPIDEX BROJ - ULJA0203
	Q8 REMBRANT EP2	5 kilograma	RAPIDEX BROJ - ULJA0183
	Q8 REMBRANT EP2	0,4 kilograma	RAPIDEX BROJ - ULJA0167
	Q8 RUBENS 00	18 kilograma	RAPIDEX BROJ - ULJA0184
	Q8 RUBENS WB/b	0,4 kilograma	RAPIDEX BROJ - ULJA0166

ULJE ZA KOČNICE I AUTOMATSKJE MENJAČE	Q8 BRAKE FLUID DOT4	0,25 litara	RAPIDEX BROJ - ULJA0163
	Q8 AUTO 15 ATF	20 litara	RAPIDEX BROJ - ULJA0182
	Q8 AUTO 15 ATF	1 litra	RAPIDEX BROJ - ULJA0165
	Q8 LHM MINERALNO ULJE	1 litra	RAPIDEX BROJ - ULJA0164
	-	-	-

HIDROL	Q8 HAYDN 10	208 litara	RAPIDEX BROJ - ULJA0240
	Q8 HAYDN 32	208 litara	RAPIDEX BROJ - ULJA0218
	Q8 HAYDN 46	208 litara	RAPIDEX BROJ - ULJA0212
	Q8 HAYDN 46	20 litara	RAPIDEX BROJ - ULJA0215
	Q8 HAYDN 68	208 litara	RAPIDEX BROJ - ULJA0213
	Q8 HAYDN 68	20 litara	RAPIDEX BROJ - ULJA0216
	Q8 HELLER 46	208 litara	RAPIDEX BROJ - ULJA0214
	Q8 HELLER 68	208 litara	RAPIDEX BROJ - ULJA0191
	-	-	-

ULJE ZA MENJAČ I DIFERENCJAL	Q8 T 60	75W-80	60 litara	RAPIDEX BROJ - ULJA0238
	Q8 T 60	75W-80	20 litara	RAPIDEX BROJ - ULJA0241
	Q8 T 36	75W-90	208 litara	RAPIDEX BROJ - ULJA0237
	Q8 T 65	75W-90	60 litara	RAPIDEX BROJ - ULJA0180
	Q8 T 65	75W-90	20 litara	RAPIDEX BROJ - ULJA0178
	Q8 T 35	80W	20 litara	RAPIDEX BROJ - ULJA0143
	Q8 T 55	80W-90	208 litara	RAPIDEX BROJ - ULJA0200
	Q8 T 55	80W-90	60 litara	RAPIDEX BROJ - ULJA0199
	Q8 T 55	80W-90	20 litara	RAPIDEX BROJ - ULJA0139
	Q8 T 55	80W-90	1 litra	RAPIDEX BROJ - ULJA0188
	Q8 T 55	85W-140	20 litara	RAPIDEX BROJ - ULJA0181
	-	-	-	-



NOVI SAD

Novosadski put 160
21000 Novi Sad
Srbija

Tel./Fax.

021 651 0521
021 651 0522
021 651 0523
021 651 1228
021 651 2254
060 824 8801

e mail: office@rapidex.co.rs

BEOGRAD

Milošev kladenac BB

Tel/fax.

011 406 59 48
011 406 67 82
011 406 67 83
060 824 8804

BATAJNICA

Majora Zorana
Radosavljevića 259

Tel/fax.

011 406 56 82
060 824 8816

office@rapidex.co.rs
www.rapidex.co.rs



PARAĆIN

Carice Milice 54

Tel/fax

035 8 567 611
035 8 567 671
060 824 8833

LOZNICA

Bulevar Dositeja Obradovića 70

Tel.

015 877 883
015 877 884
060 824 8810

NOVI PAZAR

Save Kovačevića 300

Tel.

020 315 156,
060 824 8824

VRANJE

Ivana Meštrovića 27

Tel.

017 410 088
060 824 8835

ČAČAK

Konjevići bb

Tel.

032 559 0037
060 824 8821

SOMBOR

XII Vojvodanske udarne
brigade 130

Tel.

025 461 481
060 824 8850

SUBOTICA

Beogradski put 21

Tel.

024 556 246
060 824 8862

VRBAS

Ivana Milutinovića 11

Tel.

021 700 087
060 824 8806



