KATALOG REZERVNIH DELOVA ZA KOMERCIJALNA VOZILA



MERCEDES

2015



ISO 9001:2008
cert. št. 141
04.09.2010
www.iso.org

KATALOG REZERVNIH DELOVA ZA KOMERCIJALNA VOZILA



www.rapidex.co.rs

MERCEDES

2015





NOVI SAD

Novosadski put 160
21000 Novi Sad
Srbija

Tel./Fax.

021 651 0521
021 651 0522
021 651 0523
021 651 1228
021 651 2254
060 824 8801

e mail: office@rapidex.co.rs



BEOGRAD ISTOK

Milošev kladenac BB

Tel/fax.

011 406 59 48
011 406 67 82
011 406 67 83
060 824 8804





PARAĆIN

Carice Milice 54

Tel/fax

035 8 567 611

035 8 567 671

060 824 8833

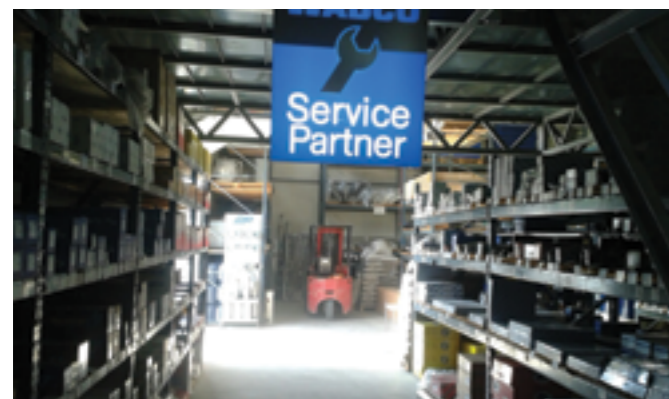

ČAČAK

Konjevići bb

Tel.

060 824 8821



LOZNICA

Bulevar Dositeja Obradovića 70

Tel.

015 877 883

015 877 884

060 824 8810

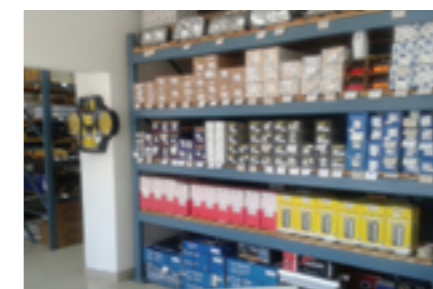

VRANJE

Ivana Meštrovića 27

Tel.

017 410 088

060 824 8835



NOVI PAZAR

Save Kovačevića br.300

Tel.

020 315 156,

060 824 8824



SOMBOR

XII Vojvođanske udarne
brigade 130

Tel.

025 461 481

060 824 8850

BEOGRAD ZAPAD

Tel.

060 824 8817



VAŽNA NAPOMENA: OVAJ KATALOG JE IZRADEN ZA SOPSTVENE POTREBE I NEĆE SE KORISTITI ZA JAVNO PUBLIKOVANJE U CELINI ILI U POJEDINAČNIM SEGMENTIMA. KORIŠTENI MATERIJAL SLUŽI ISKLJUČIVO U SVRHU IDENTIFIKOVANJA POJEDINIH REZERVNIH DELOVA KOJI SE NALAZE U ASORTIMANU ROBA RAPIDEX TRADE I U DRUGE SVRHE SE NE SME KORISTITI. ORIGINALNI BROJEVI PROIZVOĐAČA VOZILA I REZERVNIH DELOVA KORISTE SE ZA SVRHU POREĐENJA I NE SMEJU BITI POMENUTI NA RAČUNIMA KUPCA.

SADRŽAJ:

1.0 MOTOR

1.1	Delovi motora	14
1.2	Pumpe vode, ulja i upravljača	23
1.3	Termostati	29
1.4	Španeri motora i prenosni kaiševi	30
1.5	Turbo kompresori	36
1.6	Hlađenje motora (Visko ventilatori, hladnjaci, interkuleri i ekspanzione posude)	36
1.7	Hlađenje i grejanje kabine (Hladnjaci klime, kompresori klime i izmenjivači toplote).....	39
1.8	Creva vode i interkulera	40
1.9	Filteri	44
1.10	Napajanje gorivom	48
1.11	Davači i senzori	52
1.12	Izduvni sistemi	55

2.0 KVAČILO I TRANSMISIJA

2.1	Setovi kvačila i elementi	62
2.2	Centralni ležajevi kardana	69
2.3	Cilindri menjača	71

3.0 KOČIONA PNEUMATIKA I HIDRAULIKA

3.1	Kompresori i delovi	76
3.2	Isušivači vazduha i filteri	78
3.3	Ventili kočionog sistema	81
3.4	Ventili ogibljenja	92
3.5	Cilindri tristop i membranski	94
3.6	Ventili ABS, EBS i ECAS	97
3.7	Elektronika ABS, EBS i ECAS	102
3.8	Senzori	103
3.9	Cilindri kvačila	105
3.10	Pribor kočionog sistema	109
3.11	WABCO I WABCOWÜRTH dijagnostika	117

4.0 KOMPONENTE KOČIONOG SISTEMA

4.1	Disk kočnica	126
4.2	Kočione pločice	132
4.3	Čeljusti kočnica	136
4.4	Doboši kočnica	137
4.5	Kočione obloge	138
4.6	Šteleri kočnica	140
4.7	Glavčine točka, ležajevi i semerinzi	142
4.8	Vijci i navrtke	147

5.0 ELEMENTI OGIBLJENJA I UPRAVLJANJA

5.1	Amortizeri	150
5.2	Vazdušni jastuci	157
5.3	Gibnjevi	166
5.4	Delovi stabilizatora	174
5.5	Delovi rukavca	177
5.6	Spone i delovi spona	179
5.7	Uporne spone	184
5.8	V spone	185

6.0 KABINA I DELOVI KABINE

6.1	Delovi kabine	188
6.2	Ogledala i delovi ogledala	229
6.3	Cilindri i pumpe za dizanje kabine	234
6.4	Elementi za oslanjanje kabine	237
6.5	Uređaji za pranje vetrobranskog stakla	239
6.6	Mehanizam vrata	240

7.0 ELEKTRIČNE INSTALACIJE

7.1	Farovi	244
7.2	Pokazivači pravca	251
7.3	Stop i gabaritna svetla	253
7.4	Rotacione lampe	258
7.5	Sijalice, osigurači i tahograf listići	261
7.6	Kablovi električne instalacije	266
7.7	Kombinovani prekidači pod volanom	269
7.8	Akumulatori i pribor	270
7.9	Anlaseri i alternatori	274

8.0 PRIBORI

8.1	Obeležavajuće table i pribori A.D.R.	280
8.2	Oprema	295
8.3	Pribor za osiguravanje tereta	298
8.4	Lanci za sneg	300
8.5	Vučne kuke	302
8.6	Grejanje kabine	305

9.0 ULJA I MAZIVA

9.1	Ulja i maziva	311
-----	---------------------	-----

1.0 MOTOR



1.0 MOTOR

1.1	Delovi motora	14
1.2	Pumpe vode, ulja i upravljača	23
1.3	Termostati	29
1.4	Španeri motora i prenosni kaiševi	30
1.5	Turbo kompresori	36
1.6	Hlađenje motora (Visko ventilatori, hladnjaci, interkuleri i ekspanzione posude)	36
1.7	Hlađenje i grejanje kabine (Hladnjaci kabine, kompresori klime i izmenjivači toplote)	39
1.8	Creva vode i interkulera	40
1.9	Filteri	44
1.10	Napajanje gorivom	48
1.11	Davači i senzori	52
1.12	Izduvni sistemi	55

DELOVI MOTORA

Poz.	Naziv	Federal Mogul broj	Mahle broj	KS broj	Dimenzije (mm)	Tip motora	OE broj	RAPIDEX broj
1.	Klip KPL	87-174300-00	004 45 10	90 274 800	Ø97,00	OM352	352 030 17 19	MOTO0588
2.	Klip KPL	87-178200-20	004 50 00	92 581 600	Ø97,00	OM352	352 030 87 18	MOTO0738
3.	Klip KPL	87-740000-50	002 79 00	93 831 960	Ø97,50	OM364, 366	366 030 26 17	MOTO0615
4.	Klip KPL	87-740000-40	002 80 00	93 951 600	Ø97,50	OM366, 357	366 030 10 17	MOTO0384
5.	Klip KPL	87-288800-00	002 98 00	91 550 600	Ø97,50	OM366 EU I	366 030 05 18	MOTO0577
6.	Klip KPL	87-740000-10	003 02 00	91 598 600	Ø97,50	OM366 EU I turbo	366 030 01 18	MOTO0626
7.	Klip KPL	87-740000-20	002 99 00	92 525 700	Ø97,50	OM366 EU I turbo	366 030 10 18	MOTO0637
8.	Klip KPL	87-740000-00	002 81 00	94 333 600	Ø97,50	OM366 EU II turbo	366 030 14 18	MOTO0528
9.	Klip KPL	87-289300-00	003 16 00	94 705 600	Ø102	OM904, 906, EU II	906 030 05 17	MOTO0545
10.	Klip KPL	87-428900-00	-	40 030 600	Ø102	OM902 EU IV	906 030 21 18	MOTO2145
11.	Klip KPL	87-176800-00	003 45 00	92 306 600	Ø125	OM402, 403, 404	403 030 47 17	MOTO0673

DELOVI MOTORA

Poz.	Naziv	Federal Mogul broj	Mahle broj	KS broj	Dimenzije (mm)	Tip motora	OE broj	RAPIDEX broj
12.	Klip KPL	87-176000-10	003 62 00	93 231 600	Ø125	OM401A, 402LA turbo	402 030 05 17	MOTO0353
13.	Klip KPL	87-181700-00	003 66 10	93 484 602	Ø128	OM421-424	423 030 11 17	MOTO0501
14.	Klip KPL	87-179300-90	003 76 00	90 220 602	Ø128	OM441-444	422 030 08 17	MOTO0416
15.	Klip KPL	87-179300-10	003 77 00	94 512 600	Ø128	OM441-444	422 030 88 17	MOTO0385
16.	Klip KPL	87-179300-85	003 91 00	94 512 600	Ø128	OM441-444	442 030 13 37	MOTO0750
17.	Klip KPL	87-179300-80	003 76 00	90 220 602	Ø128	OM441-444	442 030 04 37	MOTO0671
18.	Klip KPL	87-179300-90	003 76 00	90 220 602	Ø128	OM441-444	442 030 11 17	MOTO0416
19.	Klip KPL	87-179300-65	003 76 00	90 220 602	Ø128	OM441-444	422 037 08 16	MOTO0134
20.	Klip KPL	87-179300-15	003 93 00	94 331 600	Ø128	OM441, 442LA EU I	442 030 13 17	MOTO0630
21.	Klip KPL	87-179300-05	003 90 00	94 681 600	Ø128	OM441, 442LA EU II	442 030 31 17	MOTO0564
22.	Klip KPL	87-179300-30	003 91 00	94 512 600	Ø128	OM447H 1985→	442 030 05 37	MOTO0639
23.	Klip KPL	87-179300-60	003 92 00	94 956 600	Ø128	OM442A EU I	442 030 30 17	MOTO0257
24.	Klip KPL	87-179300-70	003 67 00	93 485 600	Ø128	OM421-424A	442 030 03 37	MOTO0597
25.	Klip KPL	87-141800-00	004 61 00	99 948 600	Ø128	OM457 EU III	460 030 02 37	MOTO0666
26.	Klip KPL	87-743200-00	003 78 00	90 614 600	Ø130	OM441-444	444 030 04 17	MOTO0460
27.	Klip KPL	87-289600-00	001 23 00	40 448 600	Ø130	OM501, 502 96→2001	541 037 00 20	MOTO0414
28.	Klip KPL	87-136000-00	005 26 05	40 448 600	Ø130	OM501, 502, 2001→	541 030 32 37	MOTO0354
29.	Klip KPL	87-420900-00	-	40 310 600	Ø130	OM541 EU IV, V MP III	541 030 41 17	MOTO1231
30.	Košuljica	14-021850-00	004WV08	89 178 190	Ø97	OM352	352 011 18 10	MOTO0412
31.	Košuljica	14-025800-00	004WV09	89 177 190	Ø97	OM352	352 011 16 10	MOTO0411
32.	Košuljica	14-025801-00	004WV13	89 178 190	Ø97	OM352	352 011 22 10	MOTO0410
33.	Košuljica	14-012260-00	004WV10	89 198 190	Ø97,5	OM366	366 011 00 01	MOTO0718

DELOVI MOTORA								
Poz.	Naziv	Federal Mogul broj	Mahle broj	KS broj	Dimenzije (mm)	Tip motora	OE broj	RAPIDEX broj
34.	Košuljica	14-028610-00	004WV18	89 513 190	Ø102	OM904, 906	906 011 01 10	MOTO0407
35.	Košuljica	14-451660-00	003WN14	89 181 110	Ø125	OM401-404	403 011 11 10	MOTO0641
36.	Košuljica	14-458110-00	003WN24	89 380 110	Ø125	OM401, 402 EU I	403 011 11 10	MOTO0535
37.	Košuljica	14-452370-00	003WN16	89 192 110	Ø125	OM407	407 011 09 10	MOTO0534
38.	Košuljica	14-456980-00	003WN26	89 390 110	Ø128	OM447	447 011 01 10	MOTO0598
39.	Košuljica	14-451160-00	003WN15	89 180 110	Ø128	OM421-444	442 011 04 10	MOTO0502
40.	Košuljica	14-452030-00	003WN25	89 389 110	Ø128	OM421-444	444 011 01 10	MOTO0531
41.	Košuljica	14-452390-00	003WN28	89 395 110	Ø128	OM421-444	423 011 00 10	MOTO0874
42.	Košuljica	14-450380-00	001WN21	89 563 110	Ø128	OM457 EU III	457 011 00 10	MOTO0592
43.	Košuljica	14-450250-00	003WN31	89 594 110	Ø130	OM501, 502	541 011 07 10	MOTO0510
44.	Košuljica	14-458580-00	003WN32	89 594 110	Ø130	OM501, 502	541 011 03 10	MOTO0686
45.	Košuljica	14-450790-00	-	89 846 110	Ø130	OM541 EU IV, V MP III	541 030 37 37	MOTO1699
46.	Košuljica	14-456330-00	003WN23	89 396 110	Ø130	OM441-444	442 011 00 10	MOTO0459
47.	Karika	08-174300-10	00445GO	800 010 910	Ø97	OM352	352 030 05 24	MOTO0679
48.	Karika	08-740000-00	00280NO	800 019 213	Ø97,50	OM366A	376 030 00 24	MOTO0465
49.	Karika	08-288800-00	00298NO	800 526 100	Ø97,50	OM366 EU I	366 030 04 24	MOTO0469
50.	Karika	08-289300-00	00316VO	800 037 110	Ø102	OM904, 906 EU II	30309724	MOTO0223
51.	Karika	08-176800-10	00345GO	800 011 211	Ø125	OM401-404	402 030 13 0	MOTO0759
52.	Karika	08-176000-00	00362NO	800 019 411	Ø125	OM401EU I OM402EU I	402 030 01 24	MOTO0478
53.	Karika	08-181700-00	00366VO	800 019 511	Ø128	OM421-424	421 030 00 18	MOTO0221
54.	Karika	08-179300-10	00376NO	800 019 510	Ø128	OM421-444LA	422 030 00 24	MOTO0474
55.	Karika	08-289600-00	00123VO	800 032 812	Ø130	OM501-502 OM501-502	541 030 00 24	MOTO0468
56.	Karika	08-420900-00	-	800 072 210	Ø130	OM541 EU IV, V MP III	541 030 06 24	MOTO1129
57.	Karika	08-743200-00	00378NO	800019710	Ø130	OM441-444	444 030 01 24	MOTO0453

DELOVI MOTORA								
Poz.	Naziv	Federal Mogul broj	Mahle / Miba broj	KS broj	Dimenzije (mm)	Tip motora	OE broj	RAPIDEX broj
58.	Ležajevi radilice - leteći	71-3572/6	001PS10000	87 428 600	60 x 65 x 29,4	OM352 OM366	366 030 00 60	MOTO0439
59.	Ležajevi radilice - leteći	71-3850/6	001PL19799	77 824 600	70 x 75 x 28,30	OM906	906 038 00 10	MOTO0492
60.	Ležajevi radilice - leteći	71-3009	001PL10264	87 404 600	90 x 65 x 31	OM401-404	422 038 01 10	MOTO0446
61.	Ležajevi radilice - leteći	71-3693/6	001PS10764	78 902 600	90 x 95 x 26,7	OM401, OM421, OM441LA	441 038 15 11	MOTO0496
62.	Ležajevi radilice - leteći	71-3638	001PL10266	78 897 600	90 x 95 x 31	OM421-444	421 030 05 60	MOTO0498
63.	Ležajevi radilice - leteći	71-3561/6	001PS18098	87 505 600	90 x 95 x 36,20	OM407-447	407 038 01 10	MOTO0441
64.	Ležajevi radilice - leteći	71-3893/6	001PS19805	77 723 600	90 x 95 x 36,20	OM457LA	407 038 12 10	MOTO0488
65.	Ležajevi radilice - leteći	71-3835	001PL19619	77 547 600	94 x 99 x 26,60	OM501LA	541 030 00 60	MOTO0493
66.	Ležajevi radilice - leteći	71-3868	001PL19628	77 550 600	94 x 99 x 35	OM502LA	542 030 07 60	MOTO0489
67.	Ležajevi radilice - ležeći	H712/7	001HL10279	87 426 600	88 x 93 x 24,10	OM352, OM352A	352 033 07 02	MOTO0252
68.	Ležajevi radilice - ležeći	H048/7	001HL1835	77 265 600	88 x 93 x 24,10	OM366LA	366 030 03 40	MOTO0635
69.	Ležajevi radilice - ležeći	H067/7	001AL19792	77 539 600	86 x 91 x 23,30	OM906LA	906 033 07 02	MOTO0437
70.	Ležajevi radilice - ležeći	H821/4	001HS10743	87 403 600	104 x 111 x 30,5	OM401, OM421, OM441	401 586 50 03	MOTO0428
71.	Ležajevi radilice - ležeći	H821/5	001HS10003	87 401 604	104 x 111 x 30,5	OM402, OM422, OM442	402 586 20 03	MOTO0424
72.	Ležajevi radilice - ležeći	H821/6	001HS1007	87 399 600	104 x 111 x 30,5	OM403, OM423, OM443	403 030 00 40	MOTO0420
73.	Ležajevi radilice - ležeći	H821/7	001HS10743	87 397 600	104 x 111 x 30,5	OM404, OM424, OM444	404 586 50 03	MOTO0875
74.	Ležajevi radilice - ležeći	H992/7	001HS18100	87 503 600	104 x 111 x 36	OM407, OM427, OM447	407 030 06 40	MOTO0662
75.	Ležajevi radilice - ležeći	H075/7	-	79 341 600	104 x 111 x 36	OM457	457 030 01 40	MOTO2146
76.	Ležajevi radilice - ležeći	H063/4	001HS19630	77 548 600	108 x 115 x 33,5	OM501	541 030 01 40	MOTO0509
77.	Ležajevi radilice - leteći	71-3572/6	001PS10000	87 428 600	60 x 65 x 29,4	OM352 OM366	366 030 00 60	MOTO0439
78.	Ležajevi radilice - leteći	71-3850/6	001PL19799	77 824 600	70 x 75 x 28,30	OM906	906 038 00 10	MOTO0492
79.	Ležajevi radilice - leteći	71-3009	001PL10264	87 404 600	90 x 65 x 31	OM401-404	422 038 01 10	MOTO0446
80.	Ležajevi radilice - leteći	71-3693/6	001PS10764	78 902 600	90 x 95 x 26,7	OM401, OM421, OM441LA	441 038 15 11	MOTO0496

DELOVI MOTORA								
Poz.	Naziv	Federal Mogul broj	Mahle / Miba broj	KS broj	Dimenzije (mm)	Tip motora	OE broj	RAPIDEX broj
81.	Ležajevi radilice - leteći	71-3638	001PL10266	78 897 600	90 x 95 x 31	OM421-444	421 030 05 60	MOTO0498
82.	Ležajevi radilice - leteći	71-3561/6	001PS18098	87 505 600	90 x 95 x 36,20	OM407-447	407 038 01 10	MOTO0441
83.	Ležajevi radilice - leteći	71-3893/6	001PS19805	77 723 600	90 x 95 x 36,20	OM457LA	407 038 12 10	MOTO0488
84.	Ležajevi radilice - leteći	71-3835	001PL19619	77 547 600	94 x 99 x 26,60	OM501LA	541 030 00 60	MOTO0493
85.	Ležajevi radilice - leteći	71-3868	001PL19628	77 550 600	94 x 99 x 35	OM502LA	542 030 07 60	MOTO0489
86.	Ležajevi radilice - ležeći	H712/7	001HL10279	87 426 600	88 x 93 x 24,10	OM352, OM352A	352 033 07 02	MOTO0252
87.	Ležajevi radilice - ležeći	H048/7	001HL1835	77 265 600	88 x 93 x 24,10	OM366LA	366 030 03 40	MOTO0635
88.	Ležajevi radilice - ležeći	H067/7	001AL19792	77 539 600	86 x 91 x 23,30	OM906LA	906 033 07 02	MOTO0437
89.	Ležajevi radilice - ležeći	H821/4	001HS10743	87 403 600	104 x 111 x 30,5	OM401, OM421, OM441	401 586 50 03	MOTO0428
90.	Ležajevi radilice - ležeći	H821/5	001HS10003	87 401 604	104 x 111 x 30,5	OM402, OM422, OM442	402 586 20 03	MOTO0424
91.	Ležajevi radilice - ležeći	H821/6	001HS1007	87 399 600	104 x 111 x 30,5	OM403, OM423, OM443	403 030 00 40	MOTO0420
92.	Ležajevi radilice - ležeći	H821/7	001HS10743	87 397 600	104 x 111 x 30,5	OM404, OM424, OM444	404 586 50 03	MOTO0875
93.	Ležajevi radilice - ležeći	H992/7	001HS18100	87 503 600	104 x 111 x 36	OM407, OM427, OM447	407 030 06 40	MOTO0662
94.	Ležajevi radilice - ležeći	H075/7	-	79 341 600	104 x 111 x 36	OM457	457 030 01 40	MOTO2146
95.	Ležajevi radilice - ležeći	H063/4	001HS19630	77 548 600	108 x 115 x 33,5	OM501	541 030 01 40	MOTO0509
96.	Ležajevi radilice - ležeći	H064/5	001HS19631	77 549 600	108 x 115 x 33,5	OM502	542 030 02 40	MOTO0483
97.	Čaura klipnjače	55-2535	001BS10713	87 354 693	36 x 39 x 34,5	OM352, 352A	352 038 11 50	MOTO0359
98.	Čaura klipnjače	01-3438.	-	78 754 604	32 x 35 x 21	OM352, 352A	352 038 13 50	MOTO0374
99.	Čaura klipnjače	55-3854	001BB19797	77 759 690	40 x 44 x 33,7	OM904, 906	904 038 05 50	MOTO0450
100.	Čaura klipnjače	55-2862	001BB10332	87 267 690	46 x 50 x 38,70	OM401-444	403 038 02 50	MOTO0245
101.	Čaura klipnjače	55-3328	001BB19423	87 346 690	48 x 50,6 x 38,70	OM401-444	403 038 04 50	MOTO0451

DELOVI MOTORA								
Poz.	Naziv	Federal Mogul broj	Reinz broj	Elring broj	Dimenzije (mm)	Tip motora	OE broj	RAPIDEX broj
102.	Garnitura zaptivača	20-26026-05/0	01-27350-06	826.871	Ø97	OM352	352 010 26 21	MOTO0691
103.	Garnitura zaptivača	20-26026-07/0	01-27350-09	826.936	Ø97	OM352A	352 568 12 90	MOTO0697
104.	Garnitura zaptivača	20-2606-06/0	01-27350-07	813.877	Ø97,50	OM366	366 010 61 20	MOTO0876
105.	Garnitura zaptivača	20-26235-41/0	01-25105-30	826.391	Ø125, Ø128	OM401, OM421, OM441	423 010 04 20	MOTO0378
106.	Garnitura zaptivača	20-26235-42/0	01-25105-33	826.642	Ø125, Ø128	OM402, OM422, OM442	422 010 04 80	MOTO0379
107.	Garnitura zaptivača	20-26235-43/0	01-25105-32	826.626	Ø125, Ø128	OM403, OM423, OM443	423 010 06 80	MOTO0461
108.	Garnitura zaptivača	20-26235-44/0	01-25105-44	826.677	Ø125, Ø128	OM404, OM424, OM444	424 010 04 20	MOTO0877
109.	Garnitura zaptivača	20-26235-47/0	01-24105-34	827.568	Ø125, Ø128	OM407, OM427, OM447	447 010 07 20	MOTO0549
110.	Garnitura zaptivača	22-28742-00/0	01-34190-01	151.780	Ø130	OM501	541 010 13 05	MOTO0633
111.	Garnitura zaptivača	22-28744-00/0	01-34190-03	166.350	Ø130	OM502	542 010 11 05	MOTO0878
112.	Garnitura zaptivača	-	01-36115-01	058.550	Ø102	OM906	906 010 15 05	MOTO0137
113.	Set zaptivača glave	21-26026-21/0	02-27350-05	813.842	Ø97	OM352	352 010 26 21	MOTO0879
114.	Set zaptivača glave	21-26026-52/0	02-27350-04	813.877	Ø97,50	OM366	366 010 61 20	MOTO0880
115.	Set zaptivača glave	21-26235-26/0	03-25105-08	413.810	Ø125, Ø128	OM400, OM420, OM440	444 010 01 20	MOTO0118
116.	Set zaptivača glave	21-28700-50/0	03-34190-01	447.214	Ø130	OM501, OM502	541 010 11 20	MOTO0678
117.	Zaptivač glave	30-026026-50	61-27350-40	760.677	Ø97	OM352, OM352A	366 016 06 20	MOTO0382
118.	Zaptivač glave	30-026235-30	61-25105-15	451.690	Ø125, Ø128	OM400, OM420, OM440	422 016 04 20	MOTO0381
119.	Zaptivač glave	-	61-34285-10	002.281	Ø128	OM457	457 016 11 20	MOTO0676







DELOVI MOTORA								
Poz.	Naziv	Federal Mogul broj	Reinz broj	Elring broj	Dimenzije (mm)	Tip motora	OE broj	RAPIDEX broj
120.	Zaptivač glave	30-028700-00	61-34190-10	052.480	Ø130	OM501, OM502 ← 357749	541 016 11 20	MOTO0380
121.	Zaptivač glave	30-030172-00	61-37190-00	862.562	Ø130	OM501, OM502 357749 →	541 016 13 20	MOTO0645
122.	Garnitura zaptivača kartera	23-26826-01/0	10-12413-02	284.734	Ø97	OM352, OM352A, OM366	352 010 08 80	MOTO0881
123.	Zaptivač kartera	31-023576-10	71-23922-10	765.694	Ø125, Ø128	OM401, OM421, OM441	441 014 00 22	MOTO0337
124.	Zaptivač kartera	31-029967-00	71-23443-20	765.716	Ø125, Ø128	OM402, OM422, OM442	442 014 02 22	MOTO0336
125.	Zaptivač kartera	31-022812-10	71-23347-20	775.347	Ø125, Ø128	OM403, OM423, OM443	443 014 00 22	MOTO0338
126.	Zaptivač kartera	31-024668-10	71-26976-10	775.789	Ø125, Ø128	OM404, OM424, OM444	444 014 00 22	MOTO0882
127.	Zaptivač kartera	31-023336-10	71-23601-10	768.367	Ø125, Ø128	OM407, OM427, OM447	447 014 00 22	MOTO0364
128.	Zaptivač kartera	31-028743-00	71-34892-00	445.980	Ø130	OM501	541 014 03 22	MOTO0346
129.	Zaptivač kartera	31-028744-00	71-34894-00	445.990	Ø130	OM502	542 014 03 22	MOTO0345
130.	Semering radilice	50-306357-50	-	283.983	65 x 90 x 15	OM352, OM366	009 997 77 47	OSTA0310
131.	Semering radilice	50-306307-00	81-20504-40	553.272	65 x 90 x 13	OM352, OM366	014 997 16 47	OSTA0310
132.	Semering radilice	31-024323-30	71-24488-10	837.549	90 x 107 x 8	OM352, OM366	001 997 41 41	MOTO0883
133.	Semering radilice	50-307027-70	-	524.973	105 x 130 x 12	OM400, OM420, OM440	019 997 66 47	OSTA0235
134.	Semering radilice	50-306632-50	-	562.920	120 x 140 x 13	OM400, OM420, OM440	014 997 13 47	OSTA0234
135.	Semering radilice	-	81-23113-00	766.852	120 x 140 x 13 PTFE	OM400, OM420, OM440	013 997 14 47	MOTO0304
136.	Semering radilice	-	81-23112-30	766.852	105 x 130 x 12 PTFE	OM400, OM420, OM440	014 997 46 47	MOTO0305







DELOVI MOTORA						
Poz.	Naziv	Tip motora	OE broj	Dimenzije (mm)	Ugao i kraj stabla	RAPIDEX broj
137.	Ventil usisni	ATEGO OM904, 906	906 050 0326	34 x 8 x 128,90	70° I žleb	MOTO1993
138.	Ventil izduvni	ATEGO OM904, 906	906 050 0327	38 x 8 x 152,70	45° I žleb	MOTO1992
139.	Ventil usisni	OM401-404, 422-424, 407-427	403 053 0901	59 x 12 x 142,50	60° I žleb - 7mm	MOTO1713
140.	Ventil izduvni	OM401-404, 422-424, 407-427	403 050 1027	51 x 12 x 142,50	45° I žleb - 7mm	MOTO1714
141.	Ventil usisni	OM401-4, 422-4, 441-2, 427-447	422 050 0026	59 x 12 x 142,50	60° I žleb-3,5mm	MOTO1065
142.	Ventil izduvni	OM401-4, 422-4, 441-2, 427-447	422 050 0027	51 x 12 x 142,50	45° I žleb - 3,5mm	MOTO1066
143.	Ventil usisni	ACTROS OM501, 502	541 050 0226	45,5 x 9 x 145	60° I žleb	MOTO1411
144.	Ventil izduvni	ACTROS OM501, 502	541 050 0227	41 x 9 x 145	45° I žleb	MOTO1412
145.	Ventil usisni	ACTROS MP III EU V	541 053 0101	45,5 x 9 x 145	60° I žleb	MOTO2230
146.	Ventil izduvni	ACTROS MP III EU V	457 050 0327	42 x 9 x 145	54° I žleb	MOTO2231
147.	Modulacioni-5 ventil	OM401-4, 422-4, 441-2, 427-447	442 016 0391	17 x 8 x 90	-	MOTO3323
148.	Modulacioni-5 ventil	ACTROS OM501, 502	541 016 0791	17 x 8 x 87	-	MOTO1892
149.	Modulacioni-5 ventil	ATEGO OM904, 906	906 016 0491	15 x 8 x 83,5	-	MOTO2233
150.	Vodica usisnog ventila	ATEGO OM904, 906	906 053 0129	8 x 13,05 x 60	-	MOTO2234
151.	Vodica izduvnog ventila	ATEGO OM904, 906	906 053 0130	8 x 14,05 x 60	-	MOTO1177
152.	Vodica usisnog/izduvnog ventila	OM401-4, 422-4, 441-2, 427-447	422 053 0430	12 x 18,03 x 67	-	MOTO0050
153.	Vodica usisnog/izduvnog ventila	ACTROS OM501,502	541 053 1230	9 x 15,03 x 62	-	MOTO1419

1



DELOVI MOTORA				
Poz.	Naziv dela	Model / Dimenzije (mm)	OE broj	RAPIDEX broj
154.	Radilica	ATEGO OM906	906 030 11 02	MOTO2887
155.	Radilica	ACTROS MP III EU V	541 030 28 01	MOTO2374
156.	Radilica	OM441 A/LA l=26,7	441 030 21 01	MOTO0886
157.	Radilica	OM402, 422, 442 BM901	422 030 43 01 422 030 37 01	MOTO0887
158.	Radilica	ACTROS OM501	541 030 08 01	MOTO0888
159.	Klipnjača	ACTROS MP III EU V	541 030 08 20	MOTO2376
160.	Klipnjača	OM400, 420, 440 d1=46, d2=95, L=256	403 030 17 20 422 030 03 20 422 030 04 20	MOTO0264
161.	Klipnjača	OM400, 420, 440 d1=46, d2=95, L=256 trapez	442 030 00 20 442 030 02 20	MOTO0356
162.	Klipnjača	ACTROS OM501	541 030 03 20 541 030 05 20	MOTO0890
163.	Glava motora	ACTROS MP III EU V	541 010 46 21	MOTO2375
164.	Glava motora	OM441, OM422, OM442	442 010 06 20	MOTO0893
165.	Glava motora	ACTROS OM501, OM502	541 010 64 20 541 010 53 20	MOTO0894
166.	Bregasta osovina	ACTROS MP III EU V	541 050 17 01 541 050 21 01	MOTO1278
167.	Bregasta osovina	OM422A/LA, OM442A/LA	422 050 22 01	MOTO0515
168.	Bregasta osovina	ACTROS OM501	541 050 18 01 541 050 16 01 541 050 20 01 541 050 23 01	MOTO0897
169.	Vijak klipnjače	OM400, OM420, OM440 M16x1,5x67 mm	403 038 02 71	MOTO0173
170.	Vijak klipnjače	OM400, OM420, OM440 M16 x 1,5 x 67,5	442 038 00 71	MOTO0898
171.	Vijak klipnjače	ACTROS OM501, OM502 M16 x 1,5 x 73,5	541 038 00 71	MOTO0172
172.	Podizač ventila	OM400, 420, 440	403 054 18 01	MOTO0900
173.	Podizač ventila	OM400, 420, 440 ojačan	476 050 00 25	MOTO0901
174.	Ventil pumpe ulja	OM400, OM420, OM440, OM501, OM502	541 180 07 15	MOTO0507
175.	Ventil pumpe ulja	OM400, OM420, OM440	442 180 00 15	MOTO0058
176.	Uljna dizna	OM400, OM420, OM440	442 180 05 43	MOTO0142
177.	Uljna dizna	ACTROS OM501, 502	541 180 08 43	MOTO0201
178.	Separator ulja - odušak	OM400, OM420, OM440	000 018 38 35	MOTO0311
179.	Separator ulja - odušak	OM400, OM420, OM440	000 018 37 35	MOTO0904

1





PUMPE VODE						
Slika	Poz.	Model	Tip motora	Frimatec broj	OE broj	RAPIDEX broj
	1.	SPRINTER	OM611, OM612	2201110	611 200 11 01	MOTO1214
	2.	SPRINTER VIANO VITO	OM646	2201157	646 200 10 01	MOTO1710
	3.	814-2420	OM365, OM366	220845	366 200 59 01	MOTO0773
	4.	810-1620	OM352, OM362, OM366LA	220783	353 200 56 01	MOTO0774
	5.	1019-6036, BUS	OM401-403, 421-423, 440-442, 445,446	220728	403 200 51 01	MOTO0287
	6.	1019-6036, BUS Set za remont pumpe 220728	OM401-403, 421-423, 440-442, 445,446	225747	403 200 69 01	MOTO0274

PUMPE VODE						
Slika	Poz.	Model	Tip motora	Frimatec broj	OE broj	RAPIDEX broj
	7.	1222-6036, BUS Set za remont pumpe	OM441-OM443	220789 225775	403 200 57 01	MOTO0286 MOTO0273
	8.	ATEGO	OM904, OM906	220998	904 200 04 01	VESA0434
	9.	ATEGO Set za remont pumpe 220998	OM904, OM906	225816	904 200 00 04	MOTO0271
	10.	ATEGO	OM 906	2201075	906 201 16 01	MOTO0785
	11.	ATEGO	OM904LA, OM906LA, OM924LA, OM926LA	2201133	904 200 51 01	MOTO1325
	12.	ATEGO	OM904LA, OM906LA, OM924LA, OM926LA	2201114	906 200 49 01	MOTO1326



PUMPE VODE						
Slika	Poz.	Model	Tip motora	Frimatec broj	OE broj	RAPIDEX broj
	13.	ATEGO.	OM906HLA	2201136	906 200 52 01	MOTO1327
	14.	AXOR	OM457, OM457LA	2201053	457 200 05 01	MOTO0270
	15.	AXOR, TOURISMO	OM457LA/HLA	2201064	457 200 08 01	HLAĐ0579
	16.	ACTROS MP I	OM541.920(501) LA	220880 225803	541 200 12 01	MOTO0282
	17.	ACTROS MP I Sa retarderom	OM541.926 (502) LA	220881	542 201 04 01	MOTO0281
	18.	ACTROS MP II 2003→	OM541.920 (501) LA	2201070	542 200 17 01	MOTO0277

PUMPE VODE						
Slika	Poz.	Model	Tip motora	Frimatec broj	OE broj	RAPIDEX broj
	19.	ACTROS MP II Sa retarderom 2003→	OM541.926 (502) LA	2201071	542 200 18 01	MOTO0276
	20.	ACTROS MP II/MP III Sa retarderom	OM541.940-944	2201072	542 200 24 01	MOTO0146

PUMPE ULJA						
Slika	Poz.	Model	Tip motora	OE broj	RAPIDEX broj	
	1.	MK, SK, NG Do broja motora →121799	OM401, 402LA, 403, OM421, 422, 441A/LA, OM442,	403 180 17 01	MOTO1904	
	2.	MK, SK, NG Od broja motora 121800→	OM402LA, 403, 423, OM442A/LA, 443,	423 180 05 01	MOTO0779	
	3.	ATEGO	OM904, 906	906 180 06 01	MOTO0781	

PUMPE ULJA					
Slika	Poz.	Model	Tip motora	OE broj	RAPIDEX broj
	4.	AXOR	OM457 HLA	403 180 28 01	MOTO0782
	5.	ACTROS	OM501	541 180 03 01	MOTO0783
	6.	ACTROS	OM502	542 180 02 01	MOTO0784
	7.	ACTROS	OM502LA	541 180 04 01	MOTO1643

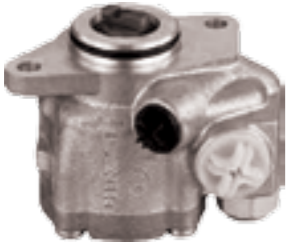
1

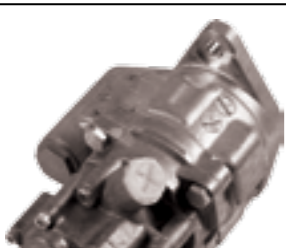
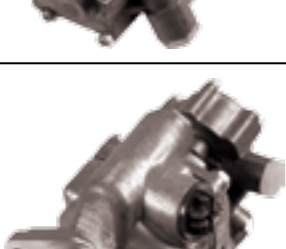
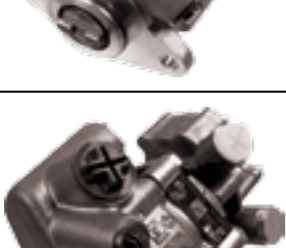
PUMPE UPRAVLJAČA				
Poz.	Slika	Model	OE broj	RAPIDEX broj
1.		1214, 1218, 1414, 1418, 1614, 1618, 2314, 2318	000 466 71 01	HIDR0011
2.		LK, MK, SK, NG, O301-307, O404-407, Unimog	000 460 14 80	HIDR0010
3.		LK, MK, SK, NG, O301-307, O404-407, Unimog	000 460 60 80	HIDR0012
4.		ACTROS 1996-2003, TRAVEGO BUS	001 460 30 80	HIDR0008
5.		ACTROS 1996-2003	001 460 31 80	HIDR0107
6.		ACTROS, ACTROS MP II/MP III	002 460 88 80	HIDR0272

1

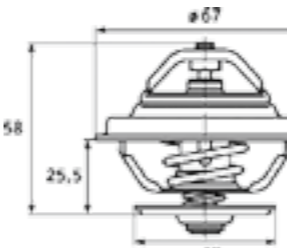
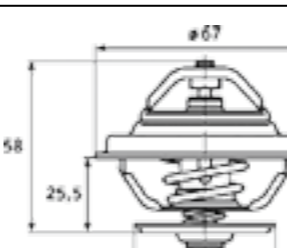
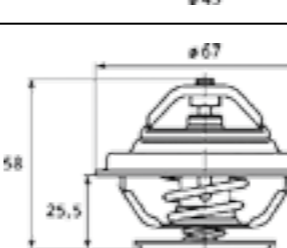
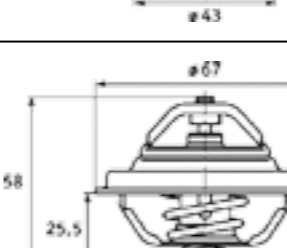
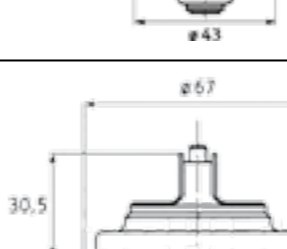
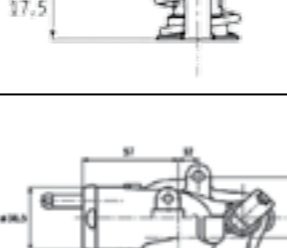
TERMOSTATI						
Slika	Poz.	Model	T [°C]	KBP	OE broj	RAPIDEX broj
	1.	VARIO, ATEGO, AXOR, ACTROS	71°C	TH1513.71J	002 203 39 75	MOTO1679
	2.	VARIO, ATEGO, AXOR, ACTROS	79°C	TH1476.79J	002 203 35 75	MOTO1682
	3.	VARIO, ATEGO, AXOR, ACTROS	80°C	TH1513.80J	004 203 43 75	MOTO1683
	4.	VARIO, ATEGO, AXOR, ACTROS	83°C	TH1513.83J	004 203 83 75	MOTO1678
	5.	ATEGO, AXOR	85°C	TH4640.85J	004 203 16 75	MOTO2097
	6.	SPRINTER, VITO	87°C	TH6847.87J	611 203 02 15	MOTO1681

ŠPANERI MOTORA					
Poz.	Slika	Model vozila	OE broj	KBP	RAPIDEX broj
1.		SPRINTER, VITO	611 200 03 70	APV2232	MOTO1691
2.		ATEGO	906 200 14 70	APV1055	MOTO1452
3.		ATEGO, AXOR	906 200 45 70	APV2817	REME0382
4.		AXOR	457 200 22 70	APV2446	MOTO1692
5.		AXOR	457 200 19 70	APV1096	MOTO1694
6.		ACTROS MP II	541 200 08 70	VKMCV51004	MOTO0155
7.		ACTROS MP I, MP II	541 200 19 70	VKMCV51019	MOTO1029



ROLERI				
Poz.	Model vozila	OE broj	KBP	RAPIDEX broj
1.	SPRINTER	000 202 09 19	APV2134	MOTO1690
2.	SPRINTER	611 234 01 93	APV2121	MOTO1761
3.	ATEGO, AXOR	906 200 44 70	APV2818	MOTO1941
4.	ATEGO, AXOR, ACTROS	000 550 08 33	4.61939	MOTO1287
5.	AXOR	457 200 10 70	APV1092	MOTO1689
6.	ACTROS	000 550 04 33	APV2411	MOTO1549



KLINASTI I PK KAIŠEVI

Poz.	Dimenzija (mm)	Model vozila / Tip motora	RAPIDEX broj
1.	13 x 1200	OM422	REME0218
2.	13 x 1250	OM422	REME0229
3.	13 x 1300	OM366	VESA0541
4.	13 x 1325	NG	REME0220
5.	13 x 1350	OM422	REME0091
6.	13 x 1375	LK	REME0092
7.	13 x 1450	O303, O405	VESA0538
8.	13 x 1475	NG, O405	REME0094
9.	13 x 1500	O301, O402, O405	REME0076
10.	13 x 1525	OM400-440	VESA0535
11.	13 x 1550	OM400-440	REME0095
12.	13 x 1575	OM400-440	REME0222
13.	13 x 1750	O305, O405	REME0224

KLINASTI I PK KAIŠEVI

Poz.	Dimenzija (mm)	Model vozila / Tip motora	RAPIDEX broj
14.	6PK 2263	SPRINTER (901, 902, 903, 904)	REME0026
15.	8PK 1158	ATEGO, AXOR	REME0111
16.	8PK 1174	ATEGO, AXOR	REME0112
17.	8PK 1183	ATEGO, AXOR	REME0113
18.	8PK 1190	ATEGO, AXOR, OM906	REME0114
19.	8PK 1205	ACTROS OM501, OM502	REME0018
20.	8PK 1215	ACTROS OM501, OM502	REME0012
21.	8PK 1220	ATEGO, AXOR, OM906, 926	REME0115
22.	8PK 1244	ATEGO, AXOR, OM906	REME0117
23.	8PK1365	ATEGO	REME0270
24.	8PK 1369	ATEGO, AXOR, OM906, 926	REME0119
25.	8PK 1390	ATEGO, AXOR, OM906, 926	REME0121
26.	8PK 1405	ATEGO, AXOR, OM906, 926	REME0122
27.	8PK 1410	ATEGO, AXOR, OM906, 926	REME0123
28.	8PK 1420	ATEGO, AXOR, OM906, 926	REME0020
29.	8PK 1427	ATEGO, AXOR, OM906, 926	REME0124
30.	8PK 1445	ATEGO, AXOR, OM906, 926	REME0125
31.	8PK 1480	ATEGO, AXOR, OM906, 926	REME0225
32.	8PK 1540	ATEGO, AXOR, OM906, 926	REME0129
33.	8PK 1580	OM457LA	REME0131
34.	8PK 1600	OM457LA	REME0133
35.	8PK 1610	OM457LA	REME0134
36.	8PK 1670	ATEGO, AXOR, OM906, 926	REME0137
37.	8PK 1730	ATEGO, AXOR, OM906, 926	REME0140
38.	8PK 1740	ATEGO, AXOR, OM906, 926	REME0141
39.	8PK 1780	ATEGO, AXOR, OM906, 926	REME0142
40.	8PK 1910	ATEGO, AXOR, OM906, 926	REME0144

KLINASTI I PK KAIŠEVI			
Poz.	Dimenzija (mm)	Model vozila / Tip motora	RAPIDEX broj
41.	8PK 1914	ATEGO, AXOR, OM906, 926	REME0145
42.	8PK 1940	ATEGO, AXOR, OM906, 926	REME0146
43.	8PK 1955	ATEGO, AXOR, OM906, 926	REME0147
44.	8PK 1960	ATEGO, AXOR, OM906, 926	REME0148
45.	8PK 1966	ATEGO, AXOR, OM906, 926	REME0149
46.	8PK 1979	ATEGO, AXOR, OM906, 926	REME0150
47.	8PK 1985	ATEGO, AXOR, OM906, 926	REME0151
48.	8PK 1993	ATEGO, AXOR, OM906	REME0152
49.	8PK 2000	ATEGO, AXOR, OM906	REME0153
50.	8PK 2040	ATEGO, AXOR, OM906, 926	REME0154
51.	8PK 2060	ATEGO, AXOR, OM906, 926	REME0157
52.	8PK2080	ATEGO	REME0227
53.	8PK 2482	ATEGO, AXOR, OM906, 926	REME0160
54.	8PK 2497	ATEGO, AXOR, OM906, 926	REME0161
55.	8PK 2515	ATEGO, AXOR, OM906, 926	REME0162
56.	8PK 2523	ATEGO, AXOR, OM906, 926	REME0163
57.	8PK 2525	ATEGO, AXOR, OM906, 926	REME0164
58.	8PK 2560	ATEGO, AXOR, OM906, 926	REME0165
59.	8PK 2600	ATEGO, AXOR, OM906, 926	REME0166
60.	8PK 2850	ATEGO, AXOR, OM906, 926	REME0167
61.	9PK 1680	OM457LA	REME0171
62.	9PK 1725	OM457LA, OM906LA	REME0172
63.	9PK 1825	OM457LA, ACTROS OM502	REME0173
64.	9PK 1880	OM457LA	REME0174
65.	9PK 1885	ACTROS OM501, OM502	REME0061
66.	9PK 1890	ACTROS OM501, OM502	REME0316
67.	9PK 1920	ACTROS OM501, OM502	REME0176

KLINASTI I PK KAIŠEVI			
Poz.	Dimenzija (mm)	Model vozila / Tip motora	RAPIDEX broj
68.	9PK 2080	ACTROS OM502	REME0177
69.	9PK 2100	OM457LA	REME0028
70.	9PK 2125	OM457HLA	REME0178
71.	9PK 2295	ACTROS OM501, OM502	REME0052
72.	9PK 2325	ACTROS OM501	REME0179
73.	9PK 2338	OM457LA	REME0180
74.	9PK 2835	ACTROS OM501, OM502	REME0065
75.	9PK 2871	ACTROS OM501, OM502	REME0024
76.	10PK 1350	ATEGO, AXOR, OM906, 926	REME0182
77.	10PK 1405	ATEGO, AXOR, OM906, 926	REME0183
78.	10PK 1620	ATEGO, AXOR, OM906	REME0187
79.	10PK 1626	ATEGO, AXOR, OM906	REME0188
80.	10PK 1670	ATEGO, AXOR, OM906	REME0189
81.	10PK 1850	ATEGO, AXOR, OM906, OM457LA	REME0194
82.	10PK 1867	ATEGO, AXOR, OM906, OM457LA	REME0196
83.	10PK 1970	ATEGO, AXOR, OM906	REME0197
84.	10PK 2240	ATEGO, AXOR, OM906	REME0200
85.	11PK 1890	ACTROS OM501, OM502	REME0013
86.	11PK 1915	ACTROS OM501, OM502	REME0202
87.	11PK 2017	ATEGO, AXOR, OM906, OM457LA	REME0203
88.	11PK 2040	ATEGO, AXOR, OM906, OM457LA	REME0204
89.	11PK 2065	OM457LA	REME0205
90.	11PK 2835	ACTROS OM501, OM502	REME0206
91.	11PK 2871	ACTROS OM501, OM502	REME0207
92.	12PK 1515	ACTROS OM501, OM502	REME0049
93.	12PK 2135	ACTROS OM501, OM502	REME0210
94.	12PK 2500	ACTROS OM501, OM502	REME0211

TURBO KOMPRESORI

Poz.	Model	OE broj	RAPIDEX broj
1.	OM422LA, OM442A	003 096 55 99	MOTO0958
2.	OM401LA	004 096 36 99	MOTO0959
3.	ATEGO OM906LA, OM906HLA	906 096 09 99	MOTO1028
4.	ACTROS OM501	007 096 47 99	MOTO0014
5.	ACTROST OM502	008 096 16 99	MOTO0960

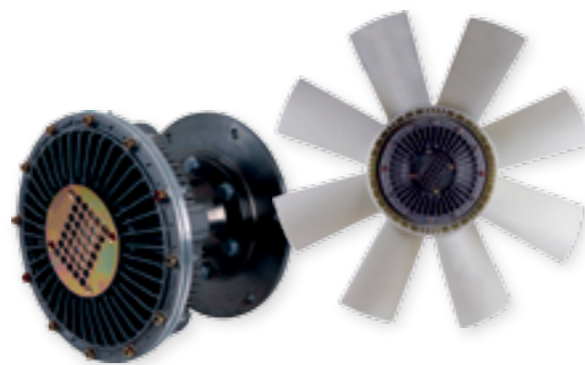
VISKO VENTILATORI

Poz.	Model	Dimenzija (mm)	OE broj	RAPIDEX broj
1.	UNIMOG U3000, U5000	Ø600 8p	904 200 10 23	MOTO1239
2.	UNIMOG U3000, U5000	Ø164,5	437 500 00 22	MOTO1238
3.	UNIMOG U300, U400	Ø184,5	904 200 06 22	MOTO1234
4.	SPRINTER 208, 214, 308, 314, 408, 414	Ø160	000 200 37 22	MOTO1251
5.	SPRINTER 210, 212, 310, 312, 410, 412	Ø160	000 200 51 22	MOTO1252
6.	SPRINTER 309CDI, 311CDI, 509CDI, 511CDI	Ø420 7p	000 200 81 23	MOTO2332
7.	VARIO 613-616, 813-816	Ø160	904 200 11 22	MOTO1240

VISKO VENTILATORI				
Poz.	Model	Dimenzija (mm)	OE broj	RAPIDEX broj
8.	ATEGO	Ø203	906 200 08 22	MOTO0936
9.	ATEGO, ATEGO 2	Ø165	904 200 08 22	MOTO1256
10.	ATEGO 2	-	906 200 09 22	MOTO1237
11.	ACTROS	Ø233	000 200 71 22	MOTO0938
12.	ACTROS	-	541 200 04 22	MOTO0552
13.	ACTROS, ACTROS MP II/MP III	Ø242	000 200 81 22	MOTO0522
14.	ACTROS MP II/MP III	Ø245	541 200 09 22	MOTO1334
15.	ACTROS MP II/MP III	Ø260	541 200 12 22	MOTO2120

HLADNJACI

Poz.	Model	Dimenzija (mm)	OE broj	RAPIDEX broj
1.	SPRINTER 308, 311, 408, 414, 416	680 x 409 x 40	901 500 35 00	HLAĐ0047
2.	SPRINTER 311, 315, 511, 515	360 x 170 x 35	003 835 89 01	HLAĐ0726
3.	VARIO	570 x 559 x 40	668 500 01 02	HLAĐ0667
4.	ATEGO	560 x 569 x 33	970 500 05 03	HLAĐ0062
5.	ATEGO, AXOR, AXOR 2	815 x 668 x 42	940 500 04 03	HLAĐ0059
6.	ACTROS	952 x 810 x 40	942 500 11 03	HLAĐ0132
7.	ACTROS, ACTROS MP II/MP III	1015 x 810 x 40	942 500 12 03	HLAĐ0133
8.	ACTROS	902 x 810 x 40	942 500 16 03	HLAĐ0417

INTERKULERI

Poz.	Model	Dimenzija (mm)	OE broj	RAPIDEX broj
1.	SPRINTER 216, 316, 416	633 x 232 x 50	901 501 10 01	HLAĐ0316
2.	VARIO	572 x 432 x 52	668 500 05 00	HLAĐ0666
3.	ATEGO, ATEGO 2	572 x 432 x 52	970 501 01 01	HLAĐ0305
4.	ATEGO, ATEGO 2	572 x 512 x 64	970 501 02 01	HLAĐ0121
5.	AXOR, AXOR 2	630 x 892 x 64	940 501 03 01	HLAĐ0526
6.	ATEGO, AXOR 2, ACTROS	596 x 712 x 64	940 501 04 01	HLAĐ0306
7.	ACTROS MP II / MP III	750 x 980 x 68	942 501 07 01	HLAĐ0610
8.	ACTROS, ACTROS MP II / MP III	752 x 852 x 66	942 501 10 01	HLAĐ0135

EKSPANZIONE POSUDE

Poz.	Model	Dimenzija (mm)	OE broj	RAPIDEX broj
1.	ATEGO, ATEGO 2	-	970 500 03 49	HLAĐ0075
2.	ACTROS 1996+2003	566 x 289 x 444 12,2 l	000 500 30 49	HLAĐ0030
3.	ACTROS 1996+2003	566 x 289 x 444 12,2 l	000 500 31 49	HLAĐ0031

HLADNJACI KLIME











Poz.	Model	Dimenzija (mm)	OE broj	RAPIDEX broj
1.	ACTROS MP I / MP II / MP III	500 x 530 x 16	970 500 01 54	HLAĐ0533













KOPRESORI KLIME

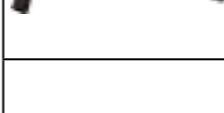









Poz.	Model	Opis	OE broj	RAPIDEX broj
1.	ACTROS MP I / MP II / MP III	3 RUPE	541 230 12 11	MOTO2545
2.	ACTROS MP I / MP II / MP III	4 RUPE	541 230 10 11	MOTO2650

IZMENJIVAČI TOPLOTE



Poz.	Model	Dimenzija (mm)	OE broj	RAPIDEX broj
1.	SPRINTER 1995+2006	152 x 170 x 40	003 835 35 01	HLAĐ0262
2.	ACTROS 1996→	390 x 226 x 40	003 835 11 01	HLAĐ0253
3.	ACTROS 2003→	370 x 175 x 32	000 830 07 20	HLAĐ0252

CREVA VODE					
Slika	Poz.	Model vozila	Dimenzije (mm)	OE broj	RAPIDEX broj
	1.	SPRINTER	65 x 65 x 820	901 528 47 82	HLAĐ0206
	2.	SPRINTER	50 x 60 x 380	901 528 43 82	HLAĐ0207
	3.	SPRINTER	42 x 42 x 290	901 501 18 82	HLAĐ0208
	4.	SPRINTER	42 x 42 x 380	901 501 11 82	HLAĐ0209
	5.	SPRINTER	60 x 65 x 610	901 528 22 82	HLAĐ0210
	6.	SPRINTER	50 x 65 x 620	901 828 18 82	HLAĐ0211
	7.	SPRINTER	42 x 42 x 440	901 501 15 82	HLAĐ0212
	8.	ATEGO	50 x 50 x 285	970 501 16 82 958 501 24 82	HLAĐ0681
	9.	ATEGO	21 x 29 x 820	958 501 28 52	HLAĐ0098
	10.	ATEGO	50 x 50 x 680	970 501 00 82	HLAĐ0096
	11.	ATEGO	21 x 21 x 400	970 501 08 82	HLAĐ0097

CREVA VODE					
Slika	Poz.	Model vozila	Dimenzije (mm)	OE broj	RAPIDEX broj
	12.	ATEGO	22 x 28 x 520	973 501 02 82	HLAĐ0099
	13.	AXOR	50 x 50 x 560	940 501 09 82	HLAĐ0222
	14.	AXOR	50 x 50 x 420	940 501 07 82	HLAĐ0682
	15.	AXOR	18 x 20 x 560	940 506 16 35	HLAĐ0220
	16.	AXOR	18 x 20 x 410	940 506 13 35	HLAĐ0221
	17.	AXOR	32 x 35 x 490	940 528 08 82	HLAĐ0213
	18.	AXOR	28 x 28 x 220	940 501 12 82	HLAĐ0214
	19.	AXOR	60 x 70 x 480	940 501 15 82	HLAĐ0215
	20.	AXOR	18 x 18 x 590	940 506 17 35	HLAĐ0216
	21.	AXOR	60 x 60 x 265	940 501 14 82	HLAĐ0217
	22.	AXOR	12 x 12 x 200	940 501 16 82	HLAĐ0218

CREVA VODE					
Slika	Poz.	Model vozila	Dimenzije (mm)	OE broj	RAPIDEX broj
	23.	AXOR	12 x 12 x 500	940 501 17 82	HLAĐ0219
	24.	AXOR	28 x 28 x 380	940 501 18 82	HLAĐ0223
	25.	AXOR	38 x 38 x 330	620 528 02 82 620 501 01 82	HLAĐ0224
	26.	ACTROS	22 x 22 x 250	942 506 31 35	HLAĐ0019
	27.	ACTROS	18 x 22 x 585	942 506 35 35 942 506 36 35	HLAĐ0095
	28.	ACTROS	18 x 18 x 285	942 506 41 35	HLAĐ0068
	29.	ACTROS	10 x 10 x 340	942 506 10 35	HLAĐ0069
	30.	ACTROS	65 x 65 x 740	941 501 03 82	HLAĐ0022
	31.	ACTROS	19 x 19 x 450	940 506 12 35	HLAĐ0084
	32.	ACTROS	20 x 22 x 340	940 506 18 35	HLAĐ0085
	33.	ACTROS	28 x 28 x 280	940 528 12 82	MOTO0159

CREVA VODE					
Slika	Poz.	Model vozila	Dimenzije (mm)	OE broj	RAPIDEX broj
	34.	ACTROS	63 x 63 x 240	941 501 05 82	HLAĐ0021
	35.	ACTROS	28 x 28 x 335	942 501 06 82	HLAĐ0020
	36.	ACTROS	22 x 22 x 450	942 466 02 81 942 466 03 81	HLAĐ0018
	37.	ACTROS	50 x 55 x 98	941 501 12 82	OSTA0248
	38.	ACTROS	50 x 60 x 98	942 501 05 82	HLAĐ0167

CREVA INTERKULERA					
Slika	Poz.	Model vozila	Dimenzija (mm)	OE broj	RAPIDEX broj
	1.	MK, SK 405	100 x 250	002 094 52 82	HLAĐ0154
	2.	ATEGO, AXOR	83 x 200	001 501 79 82	HLAĐ0341
	3.	ACTROS MP I, MP II	115 x 210	002 094 55 82	MOTO1143

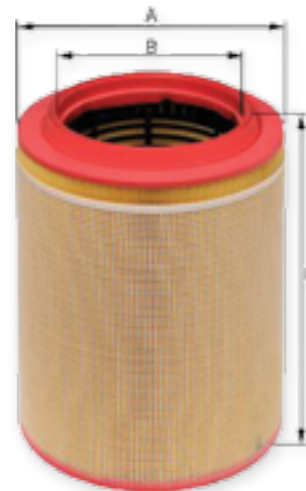
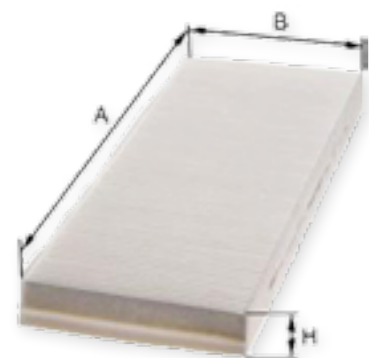
FILTERI ULJA

Poz.	Hengst broj	A (mm)	B (mm)	C (mm)	G (mm)	H (mm)	Model	OE broj	RAPIDEX broj
1.	E172HD35	83,00	37,00	37,00	-	174,00	VITO I, SPRINTER I 1996-, VITO II, SPRINTER II 2003-, VARIO	602 180 00 09	FILT0320
2.	E11HD57	64,5	29,00	29,00	-	116,00	VITO I, SPRINTER I 1996-, VITO II, SPRINTER II 2003-, VARIO	001 184 94 25	FILT0069
3.	E71HD141	70,00	29,00	29,00	-	95,00	VITO II 2003- SPRINTER II 2006-	642 180 00 09	FILT0851
4.	E11HD204	65,00	29,00	29,00	-	117,00	SPRINTER II 2006-	651 180 00 09	FILT0062
5.	E160H01D28	83,00	37,00	28,00	-	149,50	LK, VARIO ATEGO I, II 1998-	000 180 16 09	FILT0321
6.	E161H01D28	83,00	37,00	28,00	-	211,50	ATEGO I, II 1998- AXOR I, II 2001-	000 180 17 09	FILT0244
7.	E175HD129	121,00	57,00	44,5	-	263,5	AXOR I, II 2001-	000 180 21 09	FILT0303
8.	E197HD23	83,00	21,00	21,00	-	199,00	MK, SK OM401, 402	401 180 01 09	FILT0198
9.	E251HD11	120,00	13,40	-	-	270,00	NK, MK OM421, 423, 442	002 184 77 25	FILT0227
10.	E500HD129	121,00	44,50	54,00	-	311,50	ACTROS MP I, II, II 1996-	541 180 02 09	FILT0237
11.	E76HD133	220,00	27,00	27,00	-	255,00	ACTROS MP I 1996-	002 184 05 25	FILT0270
12.	E502H02D121	120,50	50,00	-	-	271,50	ACTROS MP II, III 2002-	541 180 01 09	FILT0317
13.	E181HD252	89,00	41,50	44,50	-	210,50	ACTROS MP IV 2011-	936 180 00 09	FILT1116

FILTERI GORIVA

Poz.	Hengst broj	A (mm)	B (mm)	C (mm)	G (mm)	H (mm)	Model	OE broj	RAPIDEX broj
1.	H167WK	91,00	-	-	M10 x 1,5	120,00	VITO I, SPRINTER I 1995-	665 092 06 01	FILT0077
2.	H70WK11	91,00	-	-	-	128,00	VITO I, SPRINTER I 1995-	611 092 06 01	FILT0070
3.	H278WK	86,50	-	-	10,00	129,00	VITO I, SPRINTER I 1995-, VITO II, SPRINTER II 2006-	646 092 00 01	FILT0110
4.	H216WK	86,00	-	-	-	121,00	VITO I, SPRINTER I 1995-	612 092 00 01	FILT0773
5.	H35WK02D87	89,00	62,00	72,00	M12 x 1,5	97,00	VITO I, VARIO, SPRINTER I 1995	001 092 14 52	FILT0309
6.	H140WK01	92,00	-	-	10,00	127,00	VITO II, SPRINTER II 2006-	646 092 00 01	FILT0103
7.	H330WK	92,00	-	-	11,00	137,00	SPRINTER II 2006-	649 090 22 52	FILT0761
8.	H140WK02	91,00	-	-	8,00	100,00	VITO II, SPRINTER II 2006-	649 060 16 52	FILT1172
9.	E5KFR2D12	70,00	11,00	11,00	-	115,00	LK, LP, MK, NG OM 352, 357, 401	000 092 54 05	FILT0382
10.	E10KFR4D10	83,00	13,80	13,80	-	145,00	NG, MK, SK OM 401, 421, 441	000 090 14 51	FILT0243
11.	E10KPD10	83,00	13,80	13,80	-	145,00	NG, MK, SK OM 401, 421, 441	945 508 02 00	FILT0245
12.	E52KPD36	92,00	28,00	6,00	-	101,00	VARIO, ATEGO I, ATEGO II, AXOR I, II	000 090 12 51	FILT0316
13.	E500KP02D36	106,00	46,00	14,00	-	202,50	AXOR I, II ACTROS MP I, II, III 1996-	541 092 09 05	FILT0228

SEPARATOR GORIVA

Poz.	Hengst broj	A (mm)	B (mm)	C (mm)	G (mm)	H (mm)	Model	OE broj	RAPIDEX broj
1.	H7160WK30	107,50	95,00	104,00	1-14 UNS	219,00	ATEGO II 2004-, ACTROS MP I, II 2002-	000 477 17 02	FILT0421
2.	H701WK	107,50	95,00	104,00	1-14 UNS	219,00	ATEGO I, II, AXOR I, II, ACTROS MP I, II, III	000 477 13 02	FILT0218

1

FILTERI VAZDUHA									
Poz.	Hengst broj	A (mm)	B (mm)	C (mm)	G (mm)	H (mm)	Model	OE broj	RAPIDEX broj
1.	E240L	316,50	276,50	-	-	70,50	VITO I, SPRINTER I, 1996-	003 094 82 04	FILT0068
2.	E543L	417,00	226,00	-	-	42,50	VITO II 2003-VIANO	000 090 16 51	FILT0119
3.	E209L	597,50	170,50	-	-	81,00	VARIO	002 094 93 04	FILT0301
4.	E821L	355,00	264,00	-	-	57,50	SPRINTER II 2006-	000 090 26 51	FILT0174
5.	E115L	198,00	103,00	-	-	376,00	SK (358, 625, 645-648, 655-), Unimog	001 094 42 04	FILT0075
6.	E116L	228,00	116,00	10,50	-	381,00	LK, MK, 8-24t, O303, Unimog	001 094 47 04	FILT0224
7.	E118L	302,00	191,00	-	-	473,00	O350 TOURISMO	003 094 50 04	FILT0323
8.	E133L	198,00	103,00	9,00	-	243,00	LK 809-1114 (673, 674, 675)	002 094 73 04	FILT0102
9.	E209L	597,50	170,50	-	-	81,00	T2508D-914D, LK710-914, Vario	004 094 41 04	FILT0301
10.	E214L	243,00	132,00	10,50	-	376,00	O350, O404	003 094 60 04	FILT0300
11.	E272L	327,00	191,00	10,50	-	479,00	18-35t SK (625-659)	003 094 70 04	FILT0352
12.	E273L	327,00	161,00	10,50	-	256,00	MK (650-654), SK (655-659)	003 094 49 04	FILT0242
13.	E275L	338,00	133,00	10,50	-	254,00	LK(675-679), MK(650-653), K624	001 094 93 04	FILT0074
14.	E284L	387,00	167,00	10,50	-	356,00	617-648, LK, MK, SK (625-659)	002 094 24 04	FILT0240
15.	E295L	152,00	73,00	-	-	333,00	207-210, 307-309, 408-410	003 094 51 04	FILT0087
16.	E361L	346,50	125,00	-	-	345,50	ATEGO I, II AXOR I, II	003 094 96 04	FILT0289
17.	E297L	420,00	254,00	10,50	-	262,50	ATEGO I, AXOR I ACTROS MP I	004 094 33 04	FILT0296
18.	E312L	420,00	280,00	10,50	-	305,00	ATEGO I, AXOR I ACTROS MP I	003 094 91 04	FILT0294
19.	E314L	281,50	127,00	-	-	414,50	ACTROS MP I	004 094 02 04	FILT0293
20.	E315L	350,00	184,00	-	-	49,50	ATEGO I, AXOR II ACTROS MP I, II	004 094 11 0 4	FILT0292
21.	E497L	520,50	221,80	-	-	332,30	AXOR I, II ACTROS MP II	004 094 25 04	FILT0318
22.	E603L	265,00	170,00	-	-	530,00	AXOR II, ACTROS MP II, III	004 094 35 04	FILT0234

1

FILTERI KABINE									
Poz.	Hengst broj	A (mm)	B (mm)	C (mm)	G (mm)	H (mm)	Model	OE broj	RAPIDEX broj
1.	E912LI	374,00	167,00	-	-	28,00	VITO I, SPRINTER I 1996-	000 830 33 18	FILT0159
2.	E2913LI	345,00	200,00	-	-	34,00	VITO II 2003-	639 835 02 47	FILT0120
3.	E2916LI	354,00	235,00	-	-	34,00	SPRINTER II 2006-	906 830 02 18	FILT0118
4.	E933LI	579,00	163,00	-	-	38,00	ATEGO I, II AXOR I, II	973 835 01 77	FILT0268
5.	E980LI	454,00	190,00	-	-	56,00	ATEGO I, II AXOR I, II	940 835 00 47	FILT0263
6.	E1904LI	336,00	98,00	-	-	5,00	ACTROS MP I, II, III	000 835 89 47	FILT0302
7.	E931LI	389,00	134,00	-	-	33,00	ACTROS MP I, II, III	000 830 11 18	FILT0230
8.	E982LI	391,00	143,50	-	-	39,00	ACTROS MP I, II, III	000 830 12 18	FILT0001

OSTALI FILTERI									
Poz.	Hengst broj	A (mm)	B (mm)	C (mm)	G (mm)	H (mm)	Model	OE broj	RAPIDEX broj
1.	E10H02	58,00	18,50	18,50	-	100,00	SVI MODELI Filter hidraulike volana	000 184 22 25	FILT0214
2.	E70H	58,00	18,00	18,00	-	149,00	ACTROS MP I, II, III, IV, ANTOS, AROCS	000 466 29 04	FILT0272
3.	E11S04D132	50,00	23,10	40,00	-	41,00	ATEGO I, AXOR I, ACTROS MP I, II	000 090 13 51	FILT0052
4.	E11S03D29	41,00	27,00	50,00	-	53,00	ATEGO I, AXOR I, ACTROS MP I, II	000 090 07 51	NAP.0050
5.	EAS500MD38	64,60	31,00	46,50	-	120,30	ACTROS MP I, II	541 010 00 80	FILT0226
6.	EAS500M05	118,00	60,00	-	-	136,00	ACTROS MP II, III	541 010 01 63	FILT0438
7.	E102UD179 Ad blue	43,00	26,00	-	-	85,50	ATEGO II, AXOR II, ACTROS MP II, III	000 142 00 89	FILT0673



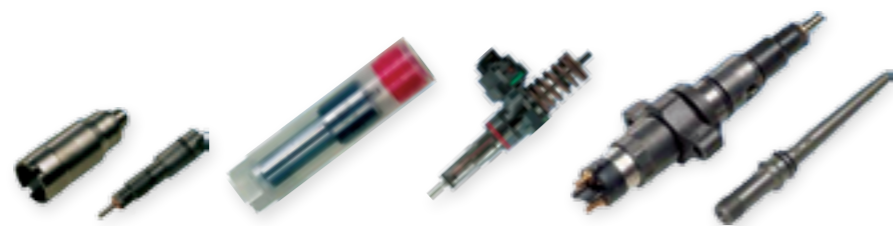

BRIZGALJKE I ULOŠCI BRIZGALJKI

Poz.	Model vozila / Tip motora	KBP	OE broj	RAPIDEX broj
1.	OM352, OM314	DLLA150S187	000 017 39 12	NAP.0081
2.	OM366, OM364	DLLA134P430	002 017 55 12	NAP.0012
3.	OM366, OM364	DLLA142S791	001 017 14 12	NAP.0114
4.	OM366, OM364, OM352	DLLA142S792	001 017 15 12	NAP.0115
5.	OM366, OM364	DLLA142S926	001 017 45 12	NAP.0116
6.	OM366, OM364	DLLA142S1096	001 017 75 12	NAP.0117
7.	OM366, OM364	DLLA142S1173	001 017 93 12	NAP.0118
8.	OM366	DLLA134S1201	002 017 10 12	NAP.0119
9.	OM442, 441	DLLA142P418	002 017 48 12	NAP.0120
10.	OM441	DLLA142P419	002 017 49 12	NAP.0121
11.	OM401, 402, 407, 404	DLLA144S485	000 017 60 12	NAP.0122
12.	OM442, 443, 441	DLLA134S999	001 017 82 12	NAP.0123
13.	OM421, 422, 423	DLLA144S829	001 017 16 12	NAP.0124
14.	OM421, 423	DLLA140S1003	001 017 30 12	NAP.0125
15.	OM441, 402, 442, 447	DLLA138S1191	001 017 97 12	NAP.0068
16.	OM441, 442	DLLA134S1199	002 017 09 12	NAP.0126
17.	ATEGO	DLLA156P1059	-	NAP.0127
18.	ATEGO	DSLA156P1411	-	NAP.0128
19.	ACTROS OM541,542	DLLA154P596	-	NAP.0062
20.	OM541, 542, 457	DLLA150P943	-	NAP.0129
21.	ACTROS OM541, 542	DLLA150P1120	-	NAP.0130
22.	OM405,407	0 432 131 780	003 017 93 21	NAP.0240
23.	ACTROS MP I	0 432 191 266	006 017 48 21	NAP.0054
24.	ACTROS MP II	0 432 191 446	005 017 13 21	NAP.0160

BRIZGALJKE I ULOŠCI BRIZGALJKI

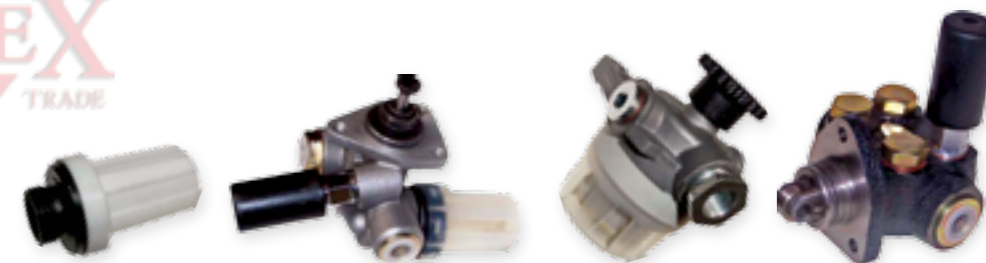
Poz.	Model vozila / Tip motora	KBP	OE broj	RAPIDEX broj
24.	ACTROS MP II	0 432 191 446	005 017 13 21	NAP.0160
25.	ACTROS MP II	0 432 191 348	005 017 45 21	NAP.0161
26.	ACTROS MP II, AXOR, CITARO, CONECTO	0 432 191 347	005 017 46 21	NAP.0162
27.	ACTROS MP II	0 432 191 363	005 017 39 21	NAP.0163
28.	ACTROS MP II	0 433 171 628	-	NAP.0129
29.	ACTROS MP II	0 433 171 740	-	NAP.0164
30.	ACTROS MP II	0 433 171 741	-	NAP.0165
31.	ACTROS MP II	0 433 171 724	-	NAP.0166
32.	SPRINTER 313/413	0 445 115 068	646 070 14 87	NAP.0364

AC PUMPE

Poz.	Model vozila	OE broj	RAPIDEX broj
1.	OM400, OM420, OM440	000 090 21 50	NAP.0176
2.	OM400, OM420, OM440	000 090 30 50	NAP.0177
3.	OM400, OM420, OM440	000 091 21 90	NAP.0072
4.	OM400, OM420, OM440 ACTROS	000 090 60 50	NAP.0021
5.	ACTROS OM501,OM502	000 090 73 50	NAP.0059
6.	UNIVERZALNA NA ŠASIJI	-	NAP.0085
7.	RUČNA PUMPA (DRUKALICA)	-	NAP.0214
8.	SPRINTER 413	611 090 03 50	NAP.0402
9.	SPRINTER 313	906 470 30 94	NAP.0327
10.	ATEGO	004 091 05 01	NAP.0033
11.	ACTROS (VOLANA I GORIVA)	002 460 39 80	HIDR0008

ČAŠICA AC PUMPE

Poz.	Model vozila	OE broj	RAPIDEX broj
1.	ACTROS/AXOR OM501, OM502, OM457 - PLASTIČNA	000 092 41 05	NAP.0050
2.	OM422, OM352 - STAKLENA SA NOSAČEM	000 092 7901	NAP.0287

REZERVOARI GORIVA

Poz.	Model vozila	Dimenzija (mm)	Zapremina (l)	RAPIDEX broj
1.	SK	1560 x 685 x 625	600	NAP.0192
2.	SPRINTER	1506 x 530 x 210	145	NAP.0193
3.	ATEGO, ACTROS	1960 x 720 x 720	930	NAP.0194

POKLOPCI

Poz.	Naziv	Model vozila	OE broj	RAPIDEX broj
1.	POKLOPAC REZERVOARA Ø80 mm	SK, MK, NG, ACTROS, AXOR	000 471 67 30	OPRE0463
2.	POKLOPAC REZERVOARA Ø80 mm	ATEGO, ACTROS, AXOR, UNIMOG	000 470 04 05	OPRE0464
3.	POKLOPAC ULJA	SK, MK, NG, ACTROS, AXOR	111 018 03 02	OPRE0465
4.	POKLOPAC HLADNJAKA	SK, MK, NG, ACTROS, AXOR	000 501 64 15	OPRE0466



PLOVCI





Poz.	Model vozila	OE broj	RAPIDEX broj
1.	ACTROS	011 542 71 17	NAP.0038
2.	ACTROS	013 542 78 17	NAP.0040
3.	AXOR	013 542 73 17	NAP.0043
4.	LK, MK, NG	008 542 80 17	NAP.0206
5.	SK	011 542 68 17	NAP.0207
6.	AXOR	013 542 72 17	NAP.0326
7.	SPRINTER	901 542 22 17	NAP.0403
8.	ATEGO	970 542 01 17	OPRE0069

DELOVI SISTEMA UBRIZGAVANJA

Poz.	Naziv	Model vozila	OE broj	RAPIDEX broj
1.	NEPOVRATNI VENTIL	ACTROS	541 070 06 46	NAP.0241
2.	SET GUMICA STEK-PUMPE	ACTROS	012 074 00 01	NAP.0293
3.	SET VENTILA ŠASIJSKE PUMPE	SK-SERIJA	000 091 13 10	NAP.0347
4.	SET VENTILA AC PUMPE NA BOSCH PUMPI	SK-SERIJA	-	NAP.0349
5.	SITO PLOVKA	ACTROS	000 471 09 35	NAP.0039
6.	POKLOPAC FILTER GORIVA	ACTROS	000 092 52 08	NAP.0047

DAVAČI I SENZORI						
Slika	Poz.	Model vozila	Tip motora	Dimenzije (mm)	OE broj	RAPIDEX broj
	1.	SPRINTER, VITO	OM642, OM651	-	006 153 95 28	MOTO2056
	2.	SPRINTER, VITO	OM642, OM651	-	003 153 27 28	ELEK1580
	3.	VARIO, ATEGO, ATEGO 2	OM904, OM906	-	004 153 42 28	MOTO0119
	4.	ACTROS	OM501,502	-	003 542 31 18	ELEK1406
	5.	ATEGO 2, AXOR, AXOR 2, ACTROS MP II/MP III	OM940,906, OM457, OM501,502	-	001 153 21 20	ELEK1369
	6.	AXOR	OM457	-	008 545 76 24	ELEK0126
	7.	ACTROS, ATEGO	OM501, 502, OM906	-	000 153 99 32	MOTO0816

DAVAČI I SENZORI						
Slika	Poz.	Model vozila	Tip motora	Dimenzije (mm)	OE broj	RAPIDEX broj
	8.	ACTROS, AXOR	OM501, 502, OM457	-	001 545 50 09	KOCN0334
	9.	ACTROS, AXOR	OM501, 502, OM457	M14 x 1,5 130°C max	004 153 25 28	NAP.0022
	10.	AXOR, SK, ACTROS	OM457, OM441LA, OM442LA OM501	-	004 153 03 28	MOTO1288
	11.	ACTROS, AXOR	OM501, 502, OM457	-	000 542 91 18	MOTO1814
	12.	ACTROS, AXOR	OM501, 502, OM457	-	001 545 73 09	MOTO0832
	13.	AXOR	OM457	-	004 153 44 28	MOTO0009
	14.	ACTROS	OM501,502	-	003 153 98 28	MOTO0182

DAVAČI I SENZORI						
Slika	Poz.	Model vozila	Tip motora	Dimenzije (mm)	OE broj	RAPIDEX broj
	15.	ACTROS, ACTROS MP II ACTROS MP III ACTROS MP IV ANTOS, AXOR, ATEGO	OM501,502, OM457, OM904,906	-	006 545 11 14	KOCN0242
	16.	ACTROS, ACTROS MP II ACTROS MP III ACTROS MP IV ANTOS, AXOR, ATEGO	OM501,502, OM457, OM904,906	-	004 545 54 14	ELEK0082
	17.	ACTROS, AXOR	OM501, 502, OM457	M18 x 1,5	001 545 49 09	ELEK1813
	18.	ACTROS	OM501, 502	-	012 542 56 17	MENJ0973
	19.	UNIMOG, ATEGO, AXOR	OM904, 906 OM457	-	970 545 01 24	HLAĐ0542
	20.	ATEGO, AXOR, ACTROS	OM904,906 OM457, OM501,502	-	004 153 04 28	HLAĐ0063

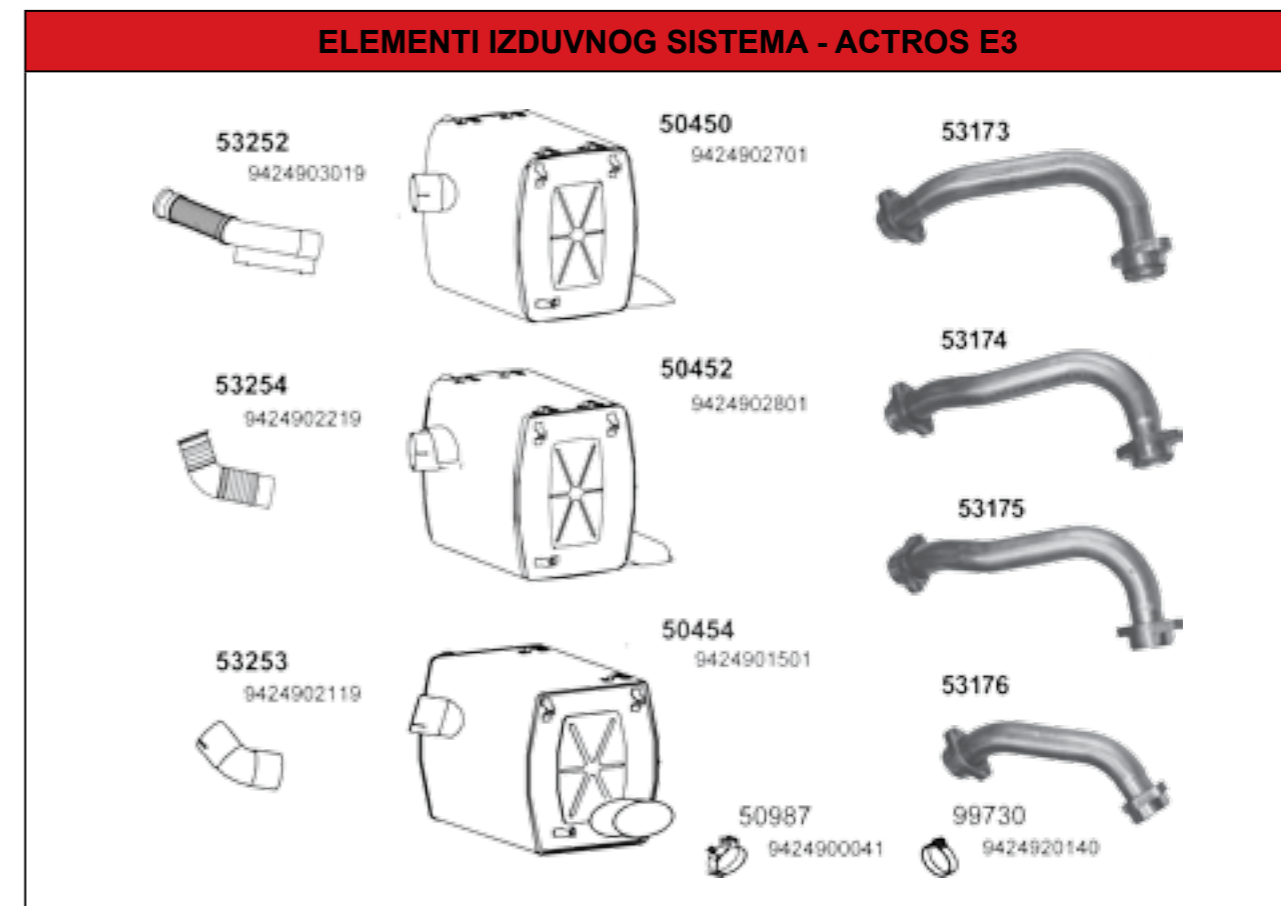

ACTROS E3				
Poz.	Naziv	Dinex broj	OE broj	RAPIDEX broj
1.	LONAC	50450	942 490 27 01	IZDU0050
2.	LONAC	50452	942 490 28 01	IZDU0125
3.	LONAC	50454	942 490 15 01	IZDU0124
4.	CEV	53252	942 490 30 19	IZDU0081
5.	CEV	53254	942 490 22 19	IZDU0376
6.	CEV	53253	942 490 21 19	IZDU0126
7.	CEV TURBINE	53173	541 140 26 03	IZDU0045
8.	CEV TURBINE	53174	541 140 25 06	IZDU0044
9.	CEV TURBINE	53175	541 140 21 03	IZDU0043
10.	CEV TURBINE	53176	541 140 22 03	IZDU0042
11.	ŠELNA	50987	942 490 00 41	IZDU0306
12.	ŠELNA	99730	942 492 01 40	IZDU0328

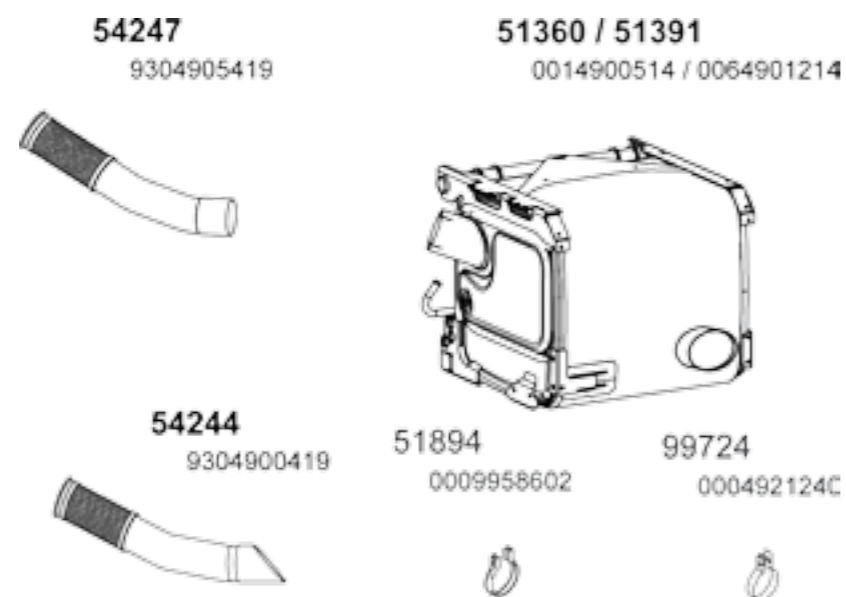
ELEMENTI IZDUVNOG SISTEMA - ACTROS E5

ACTROS E5

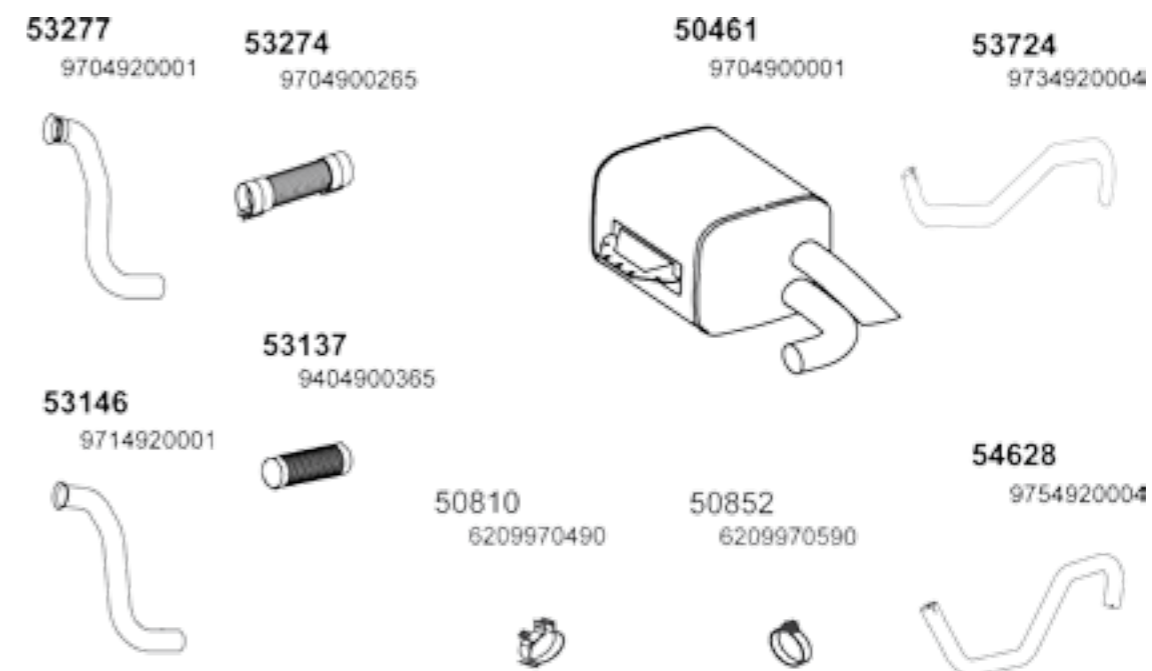
Poz.	Naziv	Dinex broj	OE broj	RAPIDEX broj
1.	LONAC	51360	001 490 05 14	IZDU0504
2.	LONAC	51391	006 490 12 14	IZDU0505
3.	CEV	54247	930 490 54 19	IZDU0275
4.	CEV	54244	930 490 04 19	IZDU0267
5.	ŠELNA	51894	000 995 86 02	IZDU0290
6.	ŠELNA	99724	000 492 12 40	IZDU0386

ELEMENTI IZDUVNOG SISTEMA - ATEGO E3

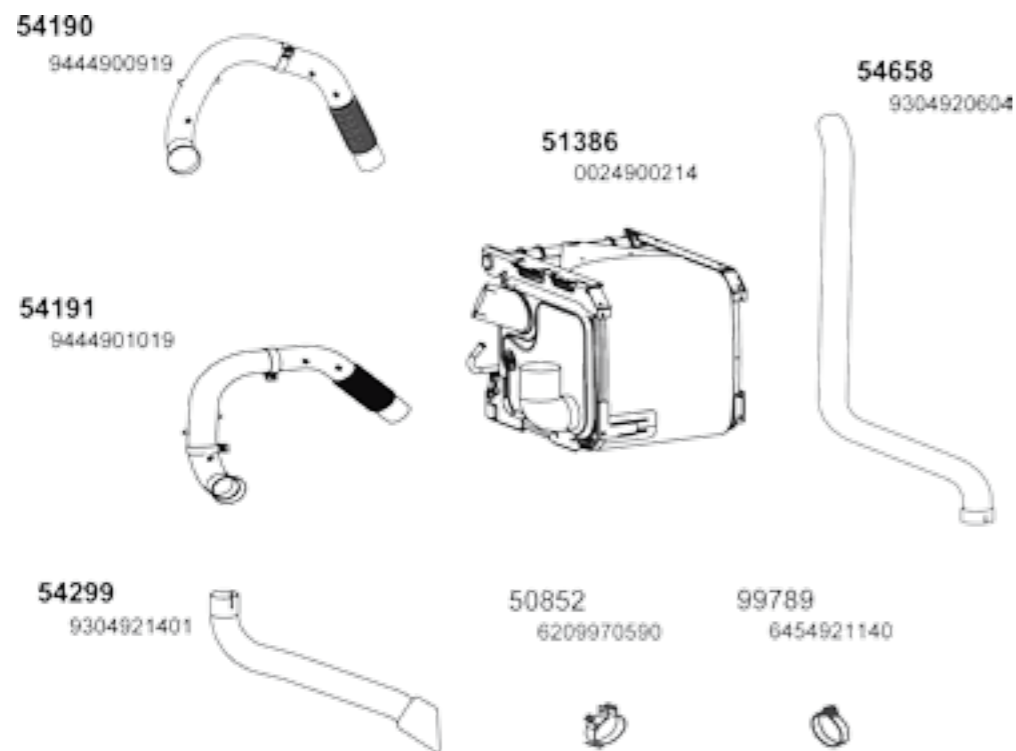
ATEGO E3

Poz.	Naziv	Dinex broj	OE broj	RAPIDEX broj
1.	LONAC	50461	970 490 00 01	IZDU0510
2.	CEV	53724	973 492 00 04	IZDU0511
3.	CEV	54628	975 492 00 04	IZDU0512
4.	CEV GIBLJIVA	53274	970 490 02 65	IZDU0293
5.	CEV GIBLJIVA	53137	940 490 03 65	IZDU0513
6.	CEV	53277	970 492 00 01	IZDU0129
7.	CEV	53146	971 492 00 01	IZDU0514
8.	ŠELNA	50810	620 997 04 90	IZDU0382
9.	ŠELNA	50852	620 997 05 90	IZDU0383

ELEMENTI IZDUVNOG SISTEMA - AXOR E4, E5

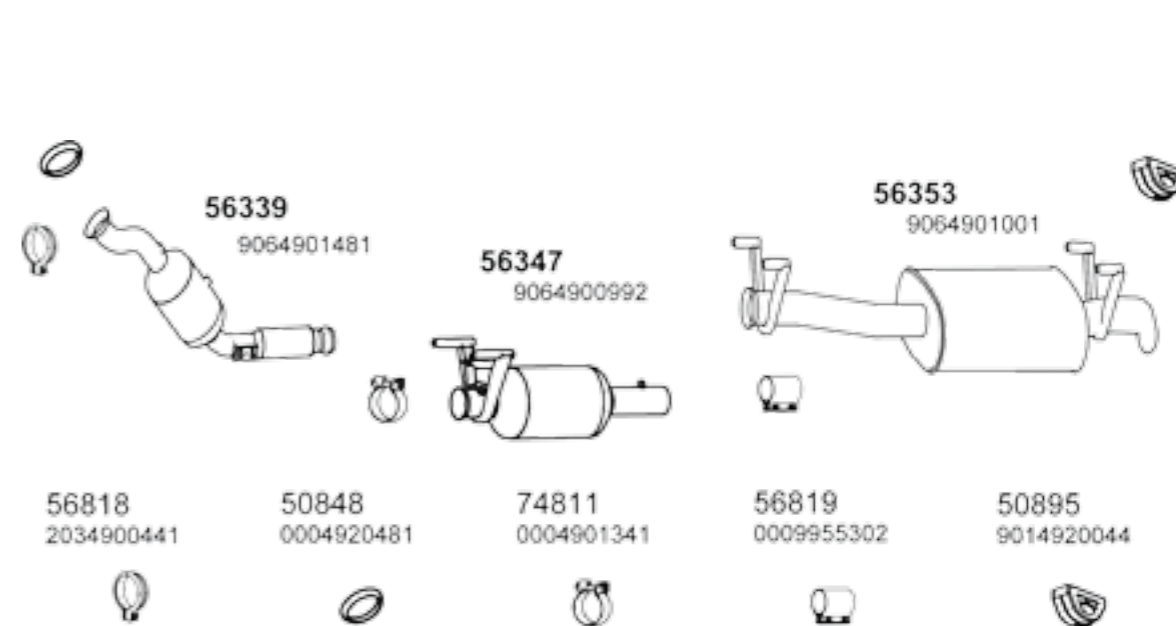
AXOR E4, E5

Poz.	Naziv	Dinex broj	OE broj	RAPIDEX broj
1.	LONAC	51386	002 490 02 14	IZDU0506
2.	CEV	54658	930 492 06 04	IZDU0507
3.	CEV	54190	944 490 09 19	IZDU0508
4.	CEV	54191	944 490 10 19	IZDU0307
5.	CEV	54299	930 492 14 01	IZDU0509
6.	ŠELNA	50852	620 997 05 90	IZDU0383
7.	ŠELNA	99789	645 492 11 40	IZDU0303

ELEMENTI IZDUVNOG SISTEMA - SPRINTER

SPRINTER

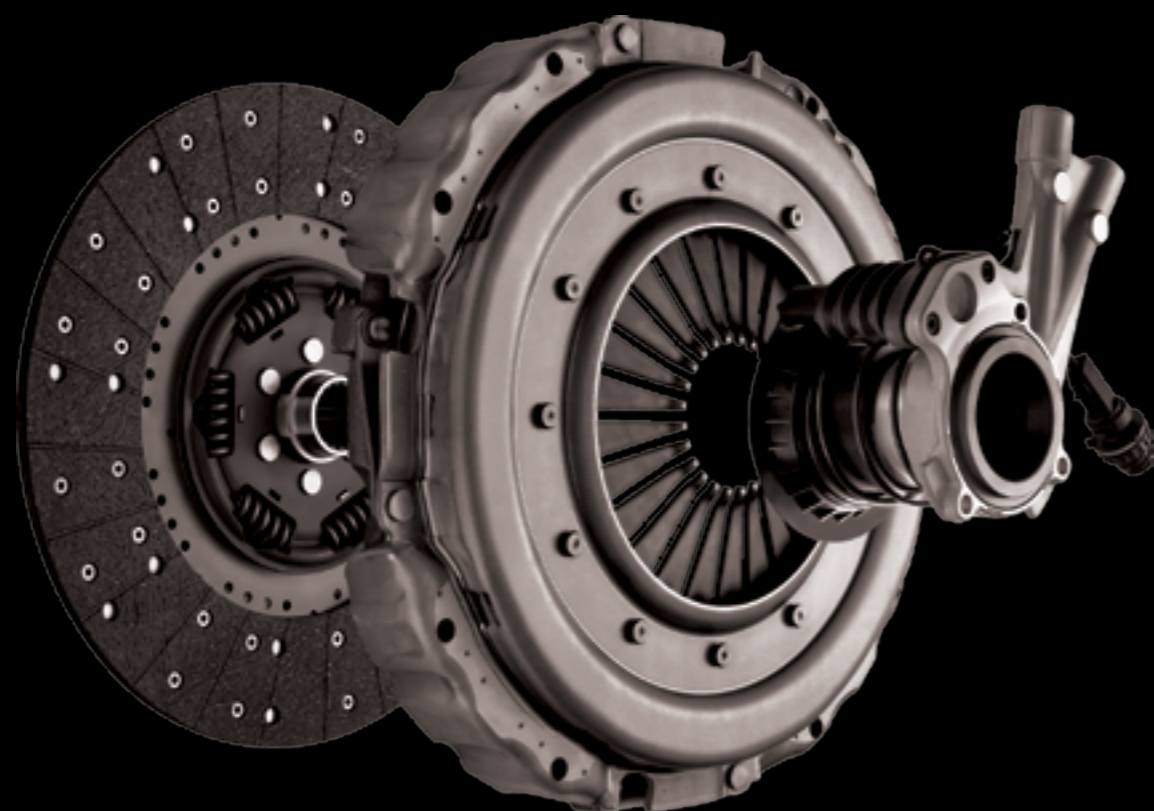
Poz.	Naziv	Dinex broj	OE broj	RAPIDEX broj
1.	KATALIZATOR	56339	906 490 14 81	IZDU0329
2.	DPF FILTER	56347	906 490 09 92	IZDU0330
3.	NOSAČ LONCA	50985	901 492 00 44	IZDU0575
4.	LONAC IZDUVNI ZADNJI	56353	906 490 10 01	IZDU0398
5.	ŠELNA KATALIZATORA	74811	000 490 13 41	IZDU0573
6.	ŠELNA LONCA	56819	000 995 53 02	IZDU0576
7.	ŠELNA KATALIZATORA	56818	203 490 04 41	IZDU0577
8.	PRSTEN ŠELNE	58848	000 492 04 81	IZDU0578

2.0 KVAČILO I TRANSMISIJA



2.0 KVAČILO I TRANSMISIJA

2.1 Setovi kvačila i elementi	62
2.2 Centralni ležajevi kardana	69
2.3 Cilindri menjača	71

SETOVI KVAČILA

Poz.	Model vozila	Prečnik	Broj zuba	KBP	OE broj	RAPIDEX broj
1.	SPRINTER	Ø240	26	3000 970 034 (bez druk ležaja) (dubina zamajca 12m)	020 250 29 01	MENJ0509
2.	SPRINTER	Ø240	26	3000 951 188 (bez druk ležaja)	023 250 83 01	KVAC0337
3.	ATEGO	Ø360	18	3400 127 701 (bez druk ležaja)	021 250 35 01	MENJ0269
4.	ATEGO, AXOR	Ø395	18	3400 121 201 (bez druk ležaja)	021 250 36 01	MENJ0285
5.	ATEGO, AXOR	Ø395	18	3400 121 301 (bez druk ležaja)	018 250 96 01	MENJ0250
6.	ACTROS	Ø400	18	3400 121 501 (dupli set)	021 250 68 01	MENJ0185
7.	MK, NG, SK	Ø430	10	3400 122 601	020 250 50 01	KVAC0270
8.	MK, SK	Ø430	10	3400 700 411	020 250 52 01	MENJ0221
9.	ACTROS	Ø430	18	3400 700 415	021 250 44 01	MENJ0444
10.	ACTROS MP I, MP II	Ø430	18	3400 700 416	022 250 33 01	MENJ0131
11.	ACTROS MP I, MP II	Ø430	18	3400 122 801	021 250 08 01	MENJ0263
12.	ACTROS MP II, AXOR 2	Ø430	18	3400 700 446	021 250 52 01	MENJ0696





POTISNI LEŽAJEVI

Poz.	Slika	Model vozila	KBP	OE broj	RAPIDEX broj
1.		MK, SK	T7000.190	001 250 09 15	MENJ0069
2.		MK, SK	T7000.180	000 250 75 15	MENJ0058
3.		MK, SK	T7000.080	000 250 19 15	KVAC0083
4.		LK, NG	T7000.030	001 250 93 15	MENJ0293
5.		MK, SK	3151 000 278	001 250 05 15	KVAC0433
6.		MK, SK	T7000.130	001 250 80 15	KVAC0160

POTISNI LEŽAJEVI

Poz.	Slika	Model vozila	KBP	OE broj	RAPIDEX broj
7.		LK, MK, NG	T7000.050	001 250 22 15	MENJ0295
8.		SPRINTER (svi modeli)	3182 997 804	000 254 25 08	KVAC0043
9.		ATEGO, ATEGO 2, AXOR 2	3182 600 166	002 250 74 15	KVAC0336
10.		ATEGO, AXOR	3182 600 172	002 250 60 15	KVAC0330
11.		ATEGO, AXOR, ACTROS	3100 002 255	002 250 41 15	MENJ0192
12.		ATEGO, AXOR	3182 998 501	000 254 30 20	MENJ0246

POTISNI LEŽAJEVI

Poz.	Slika	Model vozila	KBP	OE broj	RAPIDEX broj
13.		ATEGO, AXOR	3182 600 101	002 250 62 15	KVAC0277
14.		ATEGO, AXOR	3182 600 141	002 250 73 15	MENJ0480
15.		ATEGO, AXOR	3182 600 189	002 250 53 15	KVAC0462
16.		AXOR, ACTROS	3100 000 003	002 250 68 15	MENJ0343

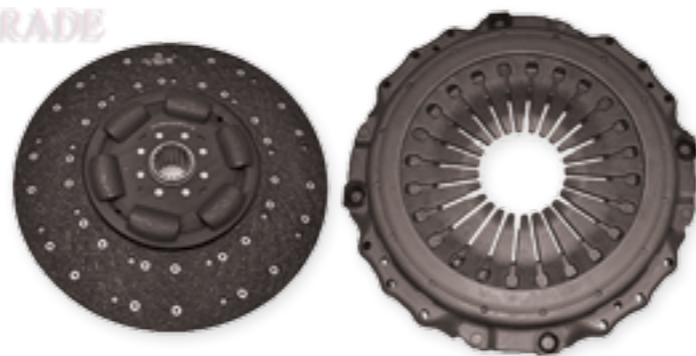

KORPE KVAČILA

Poz.	Model vozila	Prečnik	Tip	KBP	OE broj	RAPIDEX broj
1.	MK, SK, CONECTO	Ø430 mm	MFZ430	3482 081 232	004 250 56 04	KVAC0011
2.	MK, SK, CONECTO, TOURISMO	Ø430 mm	MFZ430	3482 081 231	004 250 46 04	MENJ0186
3.	ATEGO, AXOR	Ø395 mm	MF395	3482 000 464	007 25023 04	KVAC0025
4.	ATEGO, AXOR	Ø395 mm	MF395	3482 000 463	021 250 60 01	KVAC0305
5.	AXOR, ACTROS	Ø430 mm	MFZ430	3483 030 032	007 250 81 04	KVAC0014
6.	AXOR, ACTROS	Ø430 mm	MFZ430	3483 030 031	007 250 79 04	KVAC0174
7.	AXOR, ACTROS	Ø430 mm	MFZ430	3483 000 258	008 250 32 04	KVAC0487

LAMELE KVAČILA

Poz.	Model vozila	Prečnik	Broj zuba	KBP	OE broj	RAPIDEX broj
1.	LP, T2/L	Ø259mm	10	T1000.580	007 250 21 03	MENJ0223
2.	LP, NG (M1213, M813)	Ø310 mm	10	T1000.560	003 250 86 03	KVAC0066
3.	MK, NG OM 352	Ø330 mm	10	T1000.550	011 250 74 03	KVAC0109
4.	SK, NG	Ø420 mm	10	T1000.510	008 250 74 03	KVAC0067
5.	NG, SK	Ø380 mm	10	T1000.600	007 250 47 03	KVAC0065
6.	NG, SK	Ø380 mm	10	T1000.610	010 250 78 03	KVAC0064
7.	LK, NG	Ø380 mm	10	T1000.520	006 250 90 03	KVAC0116
8.	SK, NG	Ø420 mm	10	T1000.650	002 250 33 03	KVAC0100
9.	MK, SK	Ø430 mm	10	T1000.500	007 250 58 03	KVAC0114
10.	MK, SK	Ø430 mm	10	T1000.671	008 250 19 03	MENJ0219
11.	MK, SK	Ø430 mm	10	1878 080 031	017 250 85 03	MENJ0296
12.	MK, SK	Ø430 mm	10	T1000.621	012 50 86 03	MENJ0151
13.	BUS	Ø380 mm	10	T1000.530	003 250 51 03	KVAC0077
14.	CONECTO, TRAVEGO, TOURISMO	Ø430 mm	10	T1000.633	018 250 94 03	KVAC0019
15.	ATEGO, AXOR	Ø395 mm	18	1878 023 831	019 250 99 03	KVAC0304
16.	ATEGO, AXOR	Ø430 mm	18	1878 002 731	024 250 74 01	KVAC0343
17.	ACTROS, ACTROS MP II, MP III, AXOR	Ø430 mm	18	1878 005 165	021 250 86 03	KVAC0288



ZAMAJCI

Poz.	Model vozila	Prečnik (mm)	KBP	OE broj	RAPIDEX broj
1.	SPRINTER (901,902,903,904)	Ø240 mm	2294 000 519	611 030 19 05	MOTO1330
2.	SPRINTER (906)	Ø240 mm	2294 000 835	646 030 21 05	KVAC0045
3.	LK, NG	Ø310 mm	T1001.13	352 030 39 05	MOTO0370
4.	VARIO, ATEGO	Ø360 mm	3421 601 052	906 030 68 05	MENJ0437
5.	ATEGO, AXOR	Ø395 mm	4.63450	906 030 30 05	MOTO1531
6.	AXOR	Ø395 mm	3421 601 048	906 030 19 05	KVAC0456
7.	MK, SK	Ø430 mm	3421 601 012	442 030 05 05	MOTO1515
8.	AXOR	Ø430 mm	T1000.190	457 030 06 05	MOTO0973
9.	ACTROS	Ø430 mm	T1001.100	541 030 01 05	MOTO0527

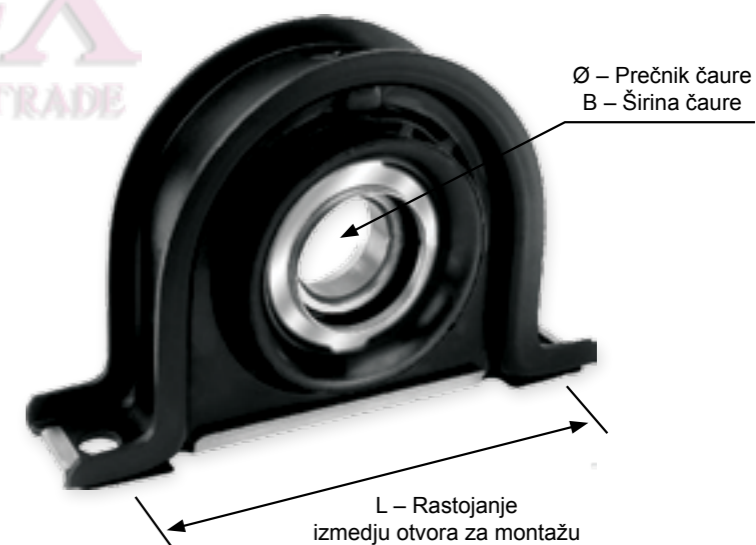

CENTRALNI LEŽAJEVI KARDANA

Poz.	Slika	Model	Ø (mm)	B (mm)	L (mm)	OE broj	RAPIDEX broj
1.		811 814	35	17	160	460 410 00 22	MENJ0764
2.		SPRINTER	45	18	194	901 411 03 12	MENJ0314
3.		SPRINTER	47	44	222	906 410 15 81	MENJ0921

CENTRALNI LEŽAJEVI KARDANA							
Poz.	Slika	Model	Ø (mm)	B (mm)	L (mm)	OE broj	RAPIDEX broj
4.		ATEGO, LK/LN2, NG, T2/LN1	45	19	191	381 410 15 22 381 410 02 22 381 410 12 22	MENJ0297
5.		ATEGO, AXOR, LK/LN2, LK, NG, SK	55	18	191	385 410 09 22 385 410 01 10 973 410 00 22	MENJ0276
6.		ATEGO, ACTROS	55	23	-	973 411 0012	MENJ0045
7.		ATEGO, ATEGO II, AXOR II, MK, NG, SK	60	22	246	654 410 00 22 389 410 02 22 389 410 01 22	MENJ0315
8.		ATEGO, AXOR II, ACTROS	70	20	246	655 410 00 22 620 410 00 10 395 410 00 22	MENJ0262
9.		ACTROS, ACTROS MP II	70	20	-	656 411 00 12	MENJ0071

CILINDRI MENJAČA						
Poz.	Slika	Model vozila	Naziv	KBP	OE broj	RAPIDEX broj
1.		ACTROS	BIRAČ BRZINA	626321AM	000 260 40 98	MENJ0284
2.		ATEGO	BIRAČ BRZINA	626661AM	000 260 41 98	MENJ0152
3.		ATEGO	BIRAČ BRZINA	626662AM	000 260 42 98	MENJ0153
4.		ATEGO	BIRAČ BRZINA	629582AM	000 260 59 98	MENJ0323
5.		ATEGO, AXOR, ACTROS	BIRAČ BRZINA	629862AM (630388AM)	000 260 60 98	MENJ0177

2

CILINDRI MENJAČA						
Poz.	Slika	Model vozila	Naziv	KBP	OE broj	RAPIDEX broj
6.		ACTROS	CILINDAR MENJAČA	626597AM	001 260 34 63	MENJ0123
7.		ATEGO	CILINDAR MENJAČA	626156AM	001 260 25 63	MENJ0078
8.		ATEGO	CILINDAR MENJAČA	626664AM	001 260 33 63	MENJ0158
9.		ATEGO, AXOR, ACTROS	CILINDAR MENJAČA	629303AM	001 260 97 63	MENJ0093
10.		ATEGO, AXOR, ACTROS	CILINDAR MENJAČA	629614AM	001 260 96 63	MENJ0345

2

CILINDRI MENJAČA						
Poz.	Slika	Model vozila	Naziv	KBP	OE broj	RAPIDEX broj
11.		ACTROS	CILINDAR MENJAČA	627494AM	001 260 59 63	MENJ0094
12.		ATEGO	CILINDAR MENJAČA	629137AM	001 260 88 63	MENJ0092
13.		ATEGO	CILINDAR MENJAČA	629138AM	001 260 91 63	MENJ0349
14.		ACTROS	CILINDAR MENJAČA	629978AM	000 260 57 98	MENJ0347
15.		ACTROS	CILINDAR MENJAČA	629979AM	000 260 58 98	MENJ0348

3.0 KOČIONA PNEUMATIKA I HIDRAULIKA



3.0 KOČIONA PNEUMATIKA I HIDRAULIKA

3.1 Kompresori i delovi	76
3.2 Isušivači vazduha i filteri	78
3.3 Ventili kočionog sistema	81
3.4 Ventili ogibljenja	92
3.5 Cilindri tristop i membranski	94
3.6 Ventili ABS, EBS i ECAS	97
3.7 Elektronika EBS i ECAS	102
3.8 Senzori	103
3.9 Cilindri kvačila	105
3.10 Pribor kočionog sistema	109
3.11 WABCO i WABCOWÜRTH dijagnostika	117

KOMPRESORI					
Poz.	Slika	WABCO broj	Model / Opis	OE broj	RAPIDEX broj
1.		-	SPRINTER	000 553 10 16	KOCN2218
2.		411 154 004 0	ATEGO, AXOR	906 130 42 15	KOCN0078
3.		912 510 104 0	AXOR	457 130 27 15	KOCN3269

GLAVE KOMPRESORA					
Poz.	Slika	WABCO broj	Model / Opis	Aparat / OE broj	RAPIDEX broj
1.		411 154 002 2	ATEGO, AXOR	000 131 51 19	KOCN2969
2.		911 553 001 2	AXOR	001 130 08 15	KOCN2909

GLAVE KOMPRESORA					
Poz.	Slika	WABCO broj	Model / Opis	Aparat / OE broj	RAPIDEX broj
3.		-	ACTROS S.TIP	541 131 11 19	KOCN0309
4.		-	ACTROS S.TIP	541 130 11 19	KOCN0310
5.		-	ACTROS	541 131 12 19	KOCN3492
6.		-	ACTROS N.TIP	541 130 27 19	KOCN0314
7.		-	ACTROS	541 130 31 19	KOCN3160
8.		-	ACTROS MP III E5 HORIZ.	541 130 37 19	KOCN2290
9.		-	ACTROS MP III E5	541 130 36 19	MOTO1879

ISUŠIVAČI VAZDUHA					
Poz.	Slika	WABCO broj / Knorr broj	Model / Opis	OE broj	RAPIDEX broj
1.		432 421 008 0	SK BEZ REDUCIRA VAZDUHA	001 431 22 15	KOCN1544
2.		432 410 104 0	SK UNIVERZALNI 8,1 bar	-	KOCN0029
3.		432 410 127 0	SK UNIVERZALNI 8,1 bar	-	KOCN0103
4.		432 410 250 0	SK UNIVERZALAN 10 bar	-	KOCN1115
5.		932 400 024 0	ATEGO, AXOR, ACTROS 12,5 bar	000 430 30 15	KOCN0254

ISUŠIVAČI VAZDUHA					
Poz.	Slika	WABCO broj / Knorr broj	Model / Opis	OE broj	RAPIDEX broj
6.		932 400 024 0	ATEGO, AXOR, ACTROS 2,5 bar	000 430 30 15	KOCN0254
7.		432 433 206 0	ACTROS DVOKOMORNI 12,5 bar	001 431 87 15	KOCN2401
8.		K033209N01	ACTROS MP III APU 12,5 bar	000 446 29 64	KOCN3351



FILTERI ISUŠIVAČA VAZDUHA





Poz.	Slika	WABCO broj	Model	Opis	RAPIDEX broj
1.		432 410 220 2	UNIMOG	Pmax = 20 bar, M42 x 1,5 mm	KOCN0463
2.		432 410 222 0	UNIVERZALNI	M39 x1,5 mm	KOCN0894
3.		432 901 223 2	UNIVERZALNI	NOVI TIP, M39 x 1,5 mm	KOCN0923

KOMBINOVANI REDUKCIONI VENTILI

Poz.	Slika	WABCO broj	Model	Opis	OE broj	RAPIDEX broj
1.		975 303 473 0	NG	8,1 bar	002 431 83 06	KOCN1358
2.		975 303 474 0	LK, LP, NG, SK, O405	8,1 bar	002 431 52 06	KOCN1341
3.		975 303 504 0	SK	10 bar	002 431 47 06	KOCN1194

ČETVOROKRUŽNI / ŠESTOKRUŽNI ZAŠTITNI VENTILI



Poz.	Slika	WABCO broj	Model	Opis	OE broj	RAPIDEX broj
1.		934 702 040 0	SK	M22/M16, MAX 10 bar, 6/5 bar	001 431 13 06	KOCN1611
2.		934 702 041 0	SK	M22/M16, MAX 10 bar, 7/6,5 bar	001 431 23 06	KOCN1121
3.		934 702 221 0	SK	M22/M16, MAX 20 bar, 7 bar	001 431 35 06	KOCN1339
4.		934 702 260 0	SK	M22, MAX 20 bar, VOSS 7 bar	002 431 73 06	KOCN1143
5.		934 714 119 0	UNIVERZALNI	M22/M16, MAX 13 bar, 7,5 bar	-	KOCN1114
6.		934 705 005 0	ATEGO, AXOR, ACTROS	M22/M12	003 431 54 06	KOCN1162

VENTILI RELEJNI					
Poz.	Slika	WABCO broj	Model	OE broj	RAPIDEX broj
1.		473 017 000 0	NG, SK	001 429 21 44	KOCN1365
2.		973 001 010 0	LK, O303,307	000 429 65 44	KOCN1354
3.		973 001 020 0	LK, LP, NG, SK	000 429 30 44	KOCN1178
4.		973 011 004 0	ATEGO, ATEGO 2, AXOR 2, ACTROS, ACTROS MP II	004 429 62 44	KOCN3213
5.		973 006 001 0	ACTROS	004 429 06 44	KOCN1229

VENTILI OGRANIČENJA PRITISKA						
Poz.	Slika	WABCO broj	Model	Izlazni / Ulazni pritisak	OE broj	RAPIDEX broj
1.		475 009 004 0	NG, SK	0,4 - 8 bar	001 429 56 44	KOCN1738
2.		475 015 015 0	NG, SK	4 - 10 bar	002 431 54 06	KOCN1211
3.		475 015 005 0	MK, NG, SK, O405	8 - 12 bar	002 431 24 06	KOCN1745
4.		475 020 006 0	MK, NG, SK, ACTROS	4,1 bar	005 429 39 44	KOCN1175
5.		475 010 314 0	EVOBUS	7 - 10 bar	005 429 04 44	KOCN0750

VENTILI BRZOG ISPUSTA						
Poz.	Slika	WABCO broj	Model	Opis	OE broj	RAPIDEX broj
1.		973 500 000 0	MK, NG, SK, O405	M22 x 1,5 mm	000 429 41 44	KOCN1273
2.		973 500 028 0	MK, SK, O405	M22 x 1,5 mm 23M16 VOSS	004 429 23 44	KOCN1141

DVOSMERNI VENTILI					
Poz.	Slika	WABCO broj	Model	OE broj	RAPIDEX broj
1.		434 202 000 0	UNIVERZALNI	-	KOCN1280
2.		434 208 000 0	UNIVERZALNI	-	KOCN0590
3.		434 208 029 0	UNIVERZALNI	-	KOCN0888

PRELIVNI VENTILI					
Poz.	Slika	WABCO broj	Model	OE broj	RAPIDEX broj
1.		434 100 125 0	UNIVERZALNI	001 429 64 44	KOCN0766
2.		434 100 130 0	UNIVERZALNI	002 429 83 44	KOCN2472
3.		434 100 228 0	UNIVERZALNI	-	KOCN2631

VENTIL RAZVODNIK					
Poz.	Slika	WABCO broj	Model	OE broj	RAPIDEX broj
1.		463 036 000 0	UNIVERZALNI	001 997 61 36	KOCN1674
2.		463 036 001 0	UNIVERZALNI	001 997 50 36	KOCN1086



ELEKTROMAGNETNI VENTILI

Poz.	Slika	WABCO broj	Model	OE broj	RAPIDEX broj
1.		472 170 600 0	SK	004 997 90 36	KOCN0993
2.		472 176 916 0	SK	005 997 67 36	KOCN0807
3.		472 070 639 0	ACTROS	005 997 12 36	KOCN0484
4.		472 072 639 0	ACTROS	005 997 11 36	KOCN0483
5.		442 040 602 0	EVOBUS	000 543 29 85	KOCN1661
6.		472 171 700 0	EVOBUS	004 997 89 36	KOCN0253

VENTILI PEDALE KOČNICE

Poz.	Slika	WABCO broj	Model	OE broj	RAPIDEX broj
1.		461 319 260 0	LK, NG	002 431 88 05	KOCN1263
2.		461 319 270 0	LK, NG	002 431 82 05	KOCN0933
3.		461 315 008 0	SK	004 429 62 05	KOCN1270
4.		461 319 271 0	SK, ACTROS	003 431 17 05	KOCN2812
5.		461 315 263 0	ATEGO	004 431 41 05	KOCN0718
6.		461 319 273 0	ATEGO	004 431 44 05	KOCN0239

VENTILI PEDALE KOČNICE

Poz.	Slika	WABCO broj	Model	OE broj	RAPIDEX broj
7.		461 319 272 0	ATEGO, ACTROS	004 431 25 05	KOCN3096
8.		461 315 264 0	ATEGO, AXOR, ACTROS	004 431 59 05	KOCN0050
9.		461 319 274 0	ATEGO, AXOR, ACTROS	004 429 62 05	KOCN0240

NAGAZNI VENTILI MOTORNE KOČNICE

Poz.	Slika	WABCO broj	Model	OE broj	RAPIDEX broj
1.		463 013 116 0	SK	000 434 08 01	KOCN1355
2.		463 013 200 0	SK	000 434 38 01	KOCN1237

VENTILI RUČNE PARKIRNE KOČNICE

Poz.	Slika	WABCO broj/ Knorr broj	Model/Opis	OE broj	RAPIDEX broj
1.		961 701 105 0	SK	000 430 55 81	KOCN2051
2.		961 722 210 0	SK	000 430 91 81	KOCN0709
3.		961 723 005 0	SK	002 430 78 81	KOCN0479
4.		961 723 104 0	SK	002 430 79 81	KOCN1004
5.		961 722 212 0	SK	001 430 02 81	KOCN1293
6.		961 703 001 0	SK, SETRA	000 430 54 81	KOCN1040

VENTILI RUČNE PARKIRNE KOČNICE

Poz.	Slika	WABCO broj/ Knorr broj	Model/Opis	OE broj	RAPIDEX broj
7.		961 722 275 0	SK, SETRA	002 430 24 81	KOCN1344
8.		961 723 125 0	ACTROS	003 430 73 81	KOCN1161
9.		DPM23A	AXOR, ACTROS	003 430 79 81	KOCN1037
10.		DPM24A	AXOR, ACTROS	003 430 75 81	KOCN1036
11.		DPM66A	AXOR, ACTROS MP II, MP III	000 420 02 84	KOCN2943







VENTILI UPRAVLJANJA PRIKOLICE

Poz.	Slika	WABCO broj	Model	OE broj	RAPIDEX broj
1.		973 002 521 0	SK	001 431 87 05	KOCN1331

VENTILI RETARDERA

Poz.	Slika	WABCO broj	Model	OE broj	RAPIDEX broj
1.		472 260 005 0	ACTROS	-	KOCN0847
2.		472 260 011 0	ACTROS	-	MENJ0330

AUTOMATSKI REGULATORI SILE KOČENJA

Poz.	Slika	WABCO broj	Model/Opis	OE broj	RAPIDEX broj
1.		475 710 036 0	MK, SK	001 431 83 12	KOCN1567
2.		475 711 027 0	MK, SK	001 431 97 12	KOCN1573
3.		475 721 005 0	ATEGO, ATEGO 2	004 431 16 12	KOCN3216
4.		475 711 118 0	ATEGO, ATEGO 2, AXOR, AXOR 2, ACTROS, ECONIC	003 431 22 12	KOCN0550
5.		475 710 136 0	ATEGO, ATEGO 2, AXOR, AXOR 2, ACTROS	003 431 27 12	KOCN0285
6.		475 711 004 0	EVOBUS	001 431 71 12	KOCN2046

VENTILI NIVELACIJE VAZDUŠNOG OGIBLJENJA

Poz.	Slika	WABCO broj	Model	OE broj	RAPIDEX broj
1.		464 002 330 0	NG	000 566 18 02	VESA0778
2.		464 006 100 0	EVOBUS	000 566 18 33	VESA0703

VENTILI NIVELACIJE KABINE

Poz.	Slika	WABCO broj	Model	OE broj	RAPIDEX broj
1.		464 007 011 0	ACTROS, ACTROS MP II, MP III	000 328 45 30	VESA0685



TRISTOP CILINDRI KAMIONSKI

Poz.	WABCO broj	Model	Opis	OE broj	RAPIDEX broj
1.	925 325 206 0	MK, NG, SK	12/16	012 420 59 18	KOCN1731
2.	925 325 216 0	SK	12/16	012 420 60 18	KOCN0583
3.	925 464 500 0	SK	G-16/24	018 420 53 18	KOCN1333
4.	925 490 925 0	SK, UNIVERZALNI	20/24	-	KOCN0989
5.	925 491 141 0	UNIVERZALNI	24/24	000 568 00 12	KOCN1084
6.	925 492 102 0	UNIVERZALNI	30"	000 568 00 11	KOCN1528
7.	925 486 101 0	ATEGO, AXOR, ACTROS	G-12/16	021 420 01 18	KOCN0785
8.	925 486 010 0	ATEGO	G-12/24	017 420 95 18	KOCN0855
9.	925 486 011 0	ATEGO	G-12/24	017 420 96 18	KOCN2804
10.	925 488 060 0	ATEGO, AXOR, ACTROS	14/16	020 420 67 18	KOCN2457
11.	925 488 000 0	ATEGO, AXOR, ACTROS	G-14/24 HFL3	020 420 13 18	KOCN1527
12.	925 488 001 0	ATEGO, AXOR, ACTROS	G-14/24 HFL3	020 420 14 18	KOCN0246
13.	925 484 021 0	ATEGO, AXOR, ACTROS	16/24	020 420 59 18	KOCN0968
14.	925 484 020 0	ATEGO, AXOR, ACTROS	16/24	015 420 63 18	KOCN2456
15.	925 488 014 0	ATEGO, AXOR, ACTROS	G-14/24 HFL3	015 420 57 18	KOCN2102

TRISTOP CILINDRI KAMIONSKI

Poz.	WABCO broj	Model	Opis	OE broj	RAPIDEX broj
16.	925 488 015 0	ATEGO, AXOR, ACTROS	G-14/24 HFL3	015 420 58 18	KOCN2103
17.	925 484 022 0	ATEGO, ATEGO 2	16/24	020 420 65 18	KOCN2818
18.	925 484 023 0	ATEGO, ATEGO 2	16/24	020 420 66 18	KOCN2817
19.	925 484 006 0	ATEGO, AXOR, ACTROS	16/24	020 420 82 18	KOCN2283
20.	925 480 004 0	AXOR, AXOR 2, ACTROS, ACTROS MP II, MP III	20/24	015 420 47 18	KOCN0498
21.	925 480 005 0	AXOR, AXOR 2, ACTROS, ACTROS MP II, MP III	20/24	019 420 64 18	KOCN1732

MEMBRANSKI CILINDRI

Poz.	WABCO broj / Knorr broj	Model	Opis	OE broj	RAPIDEX broj
1.	423 105 111 0	LK, NG, SK	DOBOŠ TIP 20	007 420 87 18	KOCN1252
2.	423 105 409 0	SK, EVOBUS	DOBOŠ TIP 20	002 420 08 24	KOCN0063
3.	423 106 106 0	LK, NG, SK	DOBOŠ TIP 24	007 420 88 18	KOCN0899
4.	423 206 700 0	SK	DOBOŠ TIP 24	006 420 16 18	KOCN0965
5.	BS3514	AXOR, ACTROS	DISK TIP 24	005 420 83 24	KOCN2154
6.	BS3515	AXOR, ACTROS	DISK TIP 24	005 420 84 24	KOCN2525

MEMBRANE TRISTOP CILINDRA				
Poz.	WABCO broj	Tip	Prečnik x Visina	RAPIDEX broj
1.	897 120 495 4	TIP 9	Ø128 x 31 mm	KOCN1555
2.	897 120 505 4	TIP 12 P	Ø139 x 31 mm	KOCN1259
3.	897 120 510 4	TIP 16 P	Ø156 x 35 mm	KOCN3087
4.	897 120 516 4	TIP 16 D	Ø158 x 43 mm	KOCN3086
5.	897 120 520 4	TIP 20 P	Ø128 x 31 mm	KOCN3089
6.	897 120 526 4	TIP 20 D	Ø168 x 38 mm	KOCN3088
7.	897 120 530 4	TIP 24 P	Ø179 x 33 mm	KOCN1231
8.	897 120 535 4	TIP 24 S	Ø179 x 40 mm	KOCN1224
9.	897 120 536 4	TIP 24 D	Ø179 x 45 mm	KOCN3125
10.	897 120 540 4	TIP 30 P	Ø199 x 35 mm	KOCN3095
11.	897 120 546 4	TIP 30 D	Ø200 x 44 mm	KOCN3094
12.	897 121 610 4	TIP 14 P	Ø139 x 28 mm	KOCN3085
13.	897 121 923 4	TIP 12 D	Ø162 x 43 mm	KOCN0926



ABS RELEJNI VENTILI					
Poz.	Slika	WABCO broj	Model	OE broj	RAPIDEX broj
1.		472 195 016 0	ATEGO, AXOR, ACTROS	004 429 65 44	KOCN0551
2.		472 195 018 0	UNIVERZALNI	-	KOCN1164

ADAPTER KABEL ABS VENTILA					
Poz.	Slika	WABCO broj	Model	OE broj	RAPIDEX broj
1.		894 601 132 2	UNIVERZALNI	-	KOCN1154
2.		894 601 133 2	UNIVERZALNI	-	KOCN1156
3.		894 601 134 2	UNIVERZALNI	-	KOCN0251

EBS VENTILI - KAMIONSKI



Poz.	Slika	WABCO broj	Model / Opis	OE broj	RAPIDEX broj
1.		480 001 010 0	AXOR, ACTROS VOSS 230	004 431 22 05	KOCN1505
2.		480 001 011 0	ACTROS MP II, MP III EBS ventil sa prigušivačem	003 431 86 06	KOCN1222
3.		480 003 000 0	ACTROS MP II, MP III	003 431 95 06	KOCN0598
4.		480 202 004 0	ACTROS Proportionalni EBS rele ventil	005 429 12 44	KOCN1167
5.		480 204 002 0	ATEGO, ATEGO 2, AXOR, AXOR 2, ACTROS, ACTROS MP II, MP III	000 431 94 13	KOCN0901

EBS VENTILI - KAMIONSKI



Poz.	Slika	WABCO broj	Model / Opis	OE broj	RAPIDEX broj
6.		480 205 001 0	AXOR, ACTROS EBS rele ventil	004 429 91 44	KOCN1500
7.		480 205 104 0	ACTROS MP II, MP III	005 429 36 44	KOCN0808



EBS VENTIL - OSOVINSKI MODULATOR

Poz.	Slika	WABCO broj	Model / Opis	OE broj	RAPIDEX broj
1.		480 103 011 0	4x2	000 429 15 24	KOCN0541
2.		480 103 012 0	6x2, 6X4, 8X4	000 429 22 24	KOCN0971
3.		480 103 015 0	4x2	000 429 26 24	KOCN0548
4.		480 103 016 0	6x2	000 429 27 24	KOCN1148
5.		480 105 006 0	ACTROS MP II, MP III	000 423 42 24	KOCN2776

ECAS ELEKTROMAGNETNI VENTIL

Poz.	Slika	WABCO broj	Model	OE broj	RAPIDEX broj
1.		472 900 001 0	SK	000 327 62 25	KOCN1166
2.		472 900 060 0	ATEGO, AXOR, ACTROS	000 327 67 25	VESA0687
3.		472 905 111 0	ATEGO, AXOR, ACTROS	000 327 68 25	VESA0612

ECAS RUČNA KOMANDA - TELEKOMADA

Poz.	WABCO broj	Model	Opis	OE broj	RAPIDEX broj
1.	446 056 113 0	SK	F/A, R/A, L/AXLE	UNIVERZALNI	VESA0700
2.	446 056 334 0	ACTROS	F/A, R/AXLE	000 545 87 13	VESA1481

ELEKTRONIKA EBS

Poz.	WABCO broj	Model / Opis	OE broj	RAPIDEX broj
1.	446 130 014 0	AXOR, ACTROS, EBS/ECU 4S/4M	000 446 26 36	KOCN1292
2.	446 130 015 0	ACTROS	000 446 25 36	KOCN0996
3.	446 130 053 0	ACTROS MP II, ECU/EPB	000 446 41 36	KOCN0947

ELEKTRONIKA ECAS - CENTRALA

Poz.	WABCO broj	Model	Opis	OE broj	RAPIDEX broj
1.	446 055 024 0	SK	6 x 2 35 - PINSKI	000 446 08 17	VESA1272
2.	446 170 025 0	ACTROS	4 x 2 18/15 - PINSKI	000 446 31 17	VESA0679
3.	446 170 055 0	ATEGO, AXOR, ACTROS	6 x 2 18/15 - PINSKI	000 446 33 17	VESA0210

SENZORI ABS

Poz.	WABCO broj	Model	Opis	OE broj	RAPIDEX broj
1.	441 032 851 0	ACTROS	1500 mm	002 542 25 18	KOCN2665
2.	441 032 921 0	ACTROS	3000 mm	001 542 88 18	KOCN1262
3.	441 032 921 2	UNIVERZALNI	400 mm, SET pod uglom	-	KOCN1147
4.	441 032 922 2	UNIVERZALNI	1000 mm, SET pod uglom	-	KOCN1322
5.	441 032 963 2	UNIVERZALNI	350 mm, SET	-	KOCN0916
6.	441 032 905 0	UNIVERZALNI	350 mm	-	KOCN1652
7.	441 032 808 0	UNIVERZALNI	400 mm, pod uglom	002 542 31 18	KOCN1216

PRODUŽNI KABEL SENZORA

Poz.	WABCO broj	Opis	RAPIDEX broj
1.	449 712 008 0	DUŽINA 800 mm	KOCN1655
2.	449 712 018 0	DUŽINA 1800 mm	KOCN0891
3.	449 712 030 0	DUŽINA 3000 mm	KOCN1107
4.	449 712 051 0	DUŽINA 5100 mm	KOCN0719
5.	449 712 060 0	DUŽINA 6000 mm	KOCN0886
6.	449 712 120 0	DUŽINA 12000 mm	KOCN0973



PREKIDAČI PRITISKA					
Poz.	Slika	WABCO broj	Opis	OE broj	RAPIDEX broj
1.		441 009 101 0	UNIVERZALNI	002 545 38 24	VESA0642
2.		441 014 006 0	UNIVERZALNI	000 763 09 10	KOCN1658
3.		441 014 010 0	UNIVERZALNI	-	VESA0488
4.		441 014 501 0	UNIVERZALNI	-	KOCN2797
5.		441 014 025 0	UNIVERZALNI	004 545 90 24	VESA0674

SENZOR PRITISKA					
Poz.	Slika	WABCO broj	Model / Opis	OE broj	RAPIDEX broj
1.		441 044 107 0	ACTROS MP I, MP II/10 bar	005 542 58 18	KOCN3419

SENZORI ECAS-a					
Poz.	Slika	WABCO broj	Model	OE broj	RAPIDEX broj
1.		441 050 008 0	LK, NG, SK	010 542 78 17	VESA0777
2.		441 050 012 0	ACTROS MP I	000 542 40 18	VESA0727
3.		441 050 121 0	ACTROS MP II	003 542 26 18	VESA0705

SERVO CILINDRI KVAČILA					
Poz.	Slika	WABCO broj	Model	OE broj	RAPIDEX broj
1.		970 051 131 0	MK, NG, SK	001 295 67 07	KVAC0158
2.		970 051 159 0	MK, NG, SK	000 295 14 18	KVAC0149
3.		970 051 445 0	MK, NG, SK	000 254 08 47	KVAC0310
4.		970 051 431 0	ATEGO, AXOR, AXOR 2, ACTROS MP II, MP III	000 254 00 47	KVAC0141
5.		970 051 433 0	ACTROS	000 295 37 18	KVAC0030
6.		970 051 441 0	ACTROS MP II, MP III	000 254 04 47	KVAC0087
7.		970 150 001 0	ACTROS MP II, AUTOMATIC	000 250 05 62	KVAC0261

PRIMARNI CILINDRI KVAČILA						
Poz.	Slika	Model	KBP	Opis / Odlivak	OE broj	RAPIDEX broj
1.		813	KG 190046.1.2	Ø19,05 mm S 5091	000 295 50 06	KVAC0124
2.		NG, SK	KG 22019.1.1	Ø22,2 mm S 5372	001 295 74 06	KVAC0132
3.		NG, SK	KG 2395.1.3	Ø23,81 mm S 5185	001 295 60 06	KVAC0156
4.		NG, SK	KG 2604.1.1	Ø26,99 mm S 5373	001 295 30 06	KVAC0161
5.		LK, LN	KG 23031.0.1	Ø23,81 mm S 5618	001 295 25 06	KVAC0356
6.		SPRINTER (906)	6284 605 004	Ø19,05 mm PLASTIKA	906 290 02 12	KVAC0472
7.		ATEGO, ATEGO 2, AXOR	KG 20001.0.8	Ø20,64 mm PLASTIKA	001 295 91 06	KVAC0118
8.		ATEGO, AXOR	MKG 20003.4.2	Ø20,64 mm PLASTIKA	002 295 10 06	KVAC0031

PRIMARNI CILINDRI KVAČILA						
Poz.	Slika	Model	KBP	Opis / Odlivak	OE broj	RAPIDEX broj
9.		ATEGO, INTEGRO, TRAVEGO	KG 20001.0.10	Ø20,64 mm PLASTIKA	001 295 95 06	KVAC0072
10.		ATEGO, AXOR	MKG 190110.4.1	Ø19,05 mm PLASTIKA	002 295 08 06	KVAC0479
11.		ACTROS MP II, MP III	MKG 190110.4.2	Ø19,05 mm PLASTIKA	002 295 07 06	KVAC0293

GLAVNI KOČIONI CILINDRI						
Poz.	Slika	Model	KBP	Opis / Odlivak	OE broj	RAPIDEX broj
1.		SPRINTER (903, 904)	H 23969.01	Ø23,81 mm	000 431 47 01	KOCN0913
2.		LP	H 38933.0.0	Ø38,1 mm S 5019	001 430 60 01	KOCN1332
3.		NG	H 17853.10.1	Ø17,46/ 20,4 mm S 5207	000 295 87 06	KOCN1343

SEKUNDARNI CILINDRI KVAČILA						
Poz.	Slika	Model	KBP	Opis / Odlivak	OE broj	RAPIDEX broj
1.		LK/LN2	KN 28027A1	Ø28,57 mm S 6469	001 295 40 07	KVAC0225
2.		NG	KN 3805J1	Ø38,1 mm S 6197	002 295 04 07	KVAC0230
3.		NG	KN 3194C1	Ø31,75 mm S 6481	001 295 44 07	KVAC0080



CREVA VAZDUHA					
Poz.	KBP	Opis	Dužina	Boja	RAPIDEX broj
1.	KG685091	SPIRALNO M16 x 1,5 mm	4,5 m	crveno	KOCN2940
2.	KG685087	SPIRALNO M16 x 1,5 mm	4,5 m	zuto	KOCN2939

SPOJNE GLAVE				
Poz.	Slika	WABCO broj	Opis	RAPIDEX broj
1.		452 802 007 0	DUOMATIC - BRZA, M16 x 1,5 mm	KOCN0743
2.		452 802 009 0	DUOMATIC - BRZA sa ABE, M16 x 1,5 mm	KOCN1044
3.		452 803 005 0	DUOMATIC - BRZA, PRIKLJUČAK ABE, M16 x 1,5 mm	KOCN0521
4.		452 804 012 0	DUOMATIC - BRZA, VUČNO VOZILO, M16 x 1,5 mm	KOCN1043
5.		452 805 004 0	DUOMATIC - BRZA, M16 x 1,5 mm	KOCN0520
6.		952 200 021 0	M16 mm, CRVENA, PRIKOLICA	KOCN1345

SPOJNE GLAVE				
Poz.	Slika	WABCO broj	Opis	RAPIDEX broj
7.		952 200 022 0	M16 mm, ŽUTA, PRIKOLICA	KOCN1346
8.		952 200 221 0	M16 mm, CRVENA, KAMION	KOCN1347
9.		952 200 222 0	M16 mm, ŽUTA, KAMION	KOCN1357
10.		952 201 001 0	SA FILTEROM, M16 mm, ŽUTA, max 8,5 bar	KOCN0827
11.		952 201 002 0	SA FILTEROM, M16 mm, CRVENA, max 8,5 bar	KOCN0826



CREVA VAZDUŠNE INSTALACIJE				
Poz.	Opis	Dužina	KBP	RAPIDEX broj
1.	4 x 1,0 mm	25 m	T 7300.15	KOCN3581
2.	5 x 1,0 mm	25 m	T 7300.27	KOCN0885
3.	6 x 1,0 mm	25 m	T 7300.01	KOCN3631
4.	8 x 1,0 mm	25 m	T 7300.02	KOCN3542
5.	9 x 1,5 mm	25 m	T 7300.14	KOCN0853
6.	10 x 1,0 mm	25 m	T 7300.03	KOCN1072
7.	12 x 1,5 mm	25 m	T 7300.04	KOCN3802
8.	15 x 1,5 mm	25 m	T 7300.05	KOCN1070
9.	18 x 2,0 mm	25 m	T 7300.20	KOCN1069
10.	NW 11 x 3,5 mm	40 m	T 7299.97	KOCN3777
11.	NW 13 x 6,0 mm	40 m	T 7299.98	KOCN3740
12.	NW 15 x 5,0 mm	40 m	T 7299.96	KOCN0902



SPOJNICE CREVA			
Poz.	WABCO broj	Opis	RAPIDEX broj
1.	893 129 401 2	CREVO 11 x 3,5 mm, M16 x 1,5 mm	OSTA0257
2.	893 129 402 2	CREVO 11 x 3,5 mm, M22x1,5 mm	OSTA0256
3.	893 129 403 2	CREVO 13 x 6 mm, M16x1,5 mm	OSTA0255
4.	893 129 404 2	CREVO 13 x 6 mm, M22x1,5 mm	OSTA0254
5.	893 226 682 2	UTIČNICA VOSS NG8 WABCO	OPRE0209
6.	893 226 689 2	ADAPTER M16 VOSS SA 232 NA 230	OPRE0021
7.	893 226 690 2	ADAPTER M22 VOSS SA 232 NA 230	OPRE0022
8.	893 800 005 2	CREVO 8 x 1 mm, M22 x 1,5 R mm	OSTA0176
9.	893 800 009 2	CREVO 10 x 1 mm, M16 x 1,5 mm	OSTA2213
10.	893 803 890 0	CREVO10 x 1 mm, M22 x 1,5 mm	OSTA1249
11.	893 800 002 2	CREVO 12 x 1,5 mm, M16 x 1,5 mm	OSTA0476
12.	893 800 008 2	CREVO 12 x 1,5 mm, M22 x 1,5 mm	OSTA0485
13.	893 800 004 2	CREVO 15 x 1,5 mm, M22 x 1,5 mm	OSTA1087
14.	893 800 007 2	CREVO 8 x 1 mm, M12 x 1,5 mm	OSTA0483
15.	893 800 001 2	CREVO 8 x 1 mm, M16 x 1,5 mm	OSTA0482

SPOJNICE CREVA			
Poz.	WABCO broj	Opis	RAPIDEX broj
16.	893 803 022 0	CREVO 6 x 1 mm, M12 x 1,5 mm	OSTA1170
17.	893 800 003 2	CREVO 16 x 2 mm, M22 x 1,5 mm	OSTA0484
18.	893 803 035 0	CREVO 6 x 2 mm, M10 x 1,5 mm	OSTA1171
19.	893 803 780 0	CREVO 15 x 2 mm, M22 x 1,5 mm	OSTA0262
20.	893 831 223 0	CREVO 6 x 1 mm, M12 x 1,5 mm, pod uglom	OSTA0477
21.	893 831 291 0	CREVO 8 x 1 mm, M12 x 1,5 mm, pod uglom	OSTA1570
22.	893 831 293 0	CREVO 8 x 1 mm, M16 x 1,5 mm, pod uglom	OSTA1136
23.	893 831 292 0	CREVO 8 x 1 mm, M22 x 1,5 mm, pod uglom	OSTA0480
24.	893 831 295 0	CREVO 12 x 1,5 mm, M16 x 1,5 mm, pod uglom	OSTA1764
25.	893 831 215 0	CREVO 15 x 1,5 mm, M16 x 1,5 mm, pod uglom	OSTA1901



KUTIJA SA SPOJNICAMA	
WABCO broj	RAPIDEX broj
893 000 200 0	OSTA1115



SPOJNICE CREVA

Slika	Poz.	Opis	KBP	RAPIDEX broj
	1.	4 mm	T 7820.00	KOCN1102
	2.	5 mm	T 7820.01	KOCN1101
	3.	6 mm	T 7820.02	KOCN1100
	4.	8 mm	T 7820.03	KOCN1099
	5.	10 mm	T 7820.04	KOCN1098
	6.	12 mm	T 7820.05	KOCN1097
	7.	15 mm	T 7820.06	KOCN1096
	8.	22 mm	T 7820.08	KOCN1095
	9.	4 mm	T 7830.00	KOCN1029
	10.	5 mm	T 7830.01	KOCN1710
	11.	6 mm	T 7830.02	KOCN1028
	12.	8 mm	T 7830.03	KOCN1027
	13.	10 mm	T 7830.04	KOCN1026
	14.	12 mm	T 7830.05	KOCN1025
	15.	15 mm	T 7830.06	KOCN1709
	16.	4 mm	T 7840.00	KOCN1022
	17.	5 mm	T 7840.01	KOCN1713
	18.	6 mm	T 7840.02	KOCN1021
	19.	8 mm	T 7840.03	KOCN1020
	20.	10 mm	T 7840.04	KOCN1019
	21.	12 mm	T 7840.05	KOCN1018
	22.	15 mm	T 7840.06	KOCN1714

ALAT ZA BRZE SPOJNICE

Poz.	Slika	WABCO broj	Opis	OE broj	RAPIDEX broj
1.		899 700 001 4	8 x 1,5 mm	-	OSTA0716
2.		899 700 002 4	12 x 1,5 mm	-	OSTA0717
3.		899 700 003 4	15 x 1,5 / 16 x 2	-	OSTA0718

PRIGUŠIVAČI ZVUKA

Poz.	Slika	WABCO broj	Opis	OE broj	RAPIDEX broj
1.		432 407 012 0	Ø87 x 62 mm	000 430 20 70	KOCN0746
2.		432 407 060 0	Ø69 x 56,5 mm	000 430 03 70	KOCN0858
3.		432 407 070 0	Ø69 x 53 mm	000 430 09 70	KOCN0859

RAPIDEX

TRADE



TEČNOST PROTIV SMRZAVANJA INSTALACIJA

Poz.	WABCO broj	Opis	RAPIDEX broj
1.	830 702 087 4	WABCOTIL 1/1	ULJA0042
2.	830 702 090 4	WABCOTIL 200/1	ULJA0043



DIJAGNOSTIKA
Hardver & Softver

WABCO

Dok je ranijih godina za dijagnostiku svakog sistema na komercijalnim vozilima bio potreban poseban dijagnostički uređaj, danas je dovoljno posedovati JEDAN da bi se uspešno rešavali problemi kako različitih SITEMA tako i različitih proizvođača VOZILA

WABCO u svojoj ponudi raspolaže sa 2 RAZLIČITA dijagnostička sistema:

- WABCO SD sistem - WABCO SISTEMSKA DIJAGNOSTIKA
- WABCO & WÜRTH sistem.

Za svaku od ovih sistema nudimo neophodnu OPREMU, PROGRAME i što je velika retkost: OBUKU.



WABCO & WÜRTH - DIJAGNOSTIČKI SISTEM

Ovaj DIJAGNOSTIČKI UREĐAJ predstavlja najsavremeniju UNIVERZALNU DIJAGNOSTIČKU ALATKU na tržištu sa nebrojeno mnogo funkcija i mogućnosti kako za rad, tako i za PERSONALIZACIJU - prema potrebama samog korisnika.

Sam sistem se može dobiti u 2 osnovne varijante:

- SA SD WABCO DIJAGNOSTIKOM
- BEZ SD WABCO DIJAGNOSTIKE

Dalje je moguća podela po delokrugu rada na:

- KOMPLETAN PAKET (SISTEMI KAMIONA, PRIKOLICE I BUS-a, LAKI TERETNI PROGRAM)
- KAMIONSKI PAKET
- PRIKOLIČNI PAKET
- BUS PAKET



WABCO & WÜRTH - DIJAGNOSTIČKI SISTEM

Sistemi na vozilima koji se mogu kontrolisati sa ovim uređajima su:

- KOČIONI SISTEM
- MENJAČ
- MOTOR
- ELEKTRIČNE INSTALACIJE
- GREJANJE I HLAĐENJE
- UPRAVLJANJE I VEŠANJE

Zbog stalnog usavršavanja i dopunjavanja teško je definisati krajnje mogućnosti rada ovog uređaja te zbog toga  omogućava proveru mogućnosti uređaja - PREZENTACIJU SVAKOM ZAINTERESOVANOM KLIJENTU kod njega na vozilima koja klijent odabere.

SVI ZAINTERESOVANI MOGU ZAKAZATI BESPLATNU PREZENTACIJU PREKO FIRME „RAPIDEX TRADE“ TE ĆE STRUČNI LJUDI  UBRZO STUPITI U KONTAKT SA ZAINTERESOVANIMA.

Više informacija se može dobiti na: <http://www.wabcowuerth.com>



WABCO

SD - SISTEMSKA DIJAGNOSTIKA

Za SD dijagnostiku WABCO sistema koristi se sledeća oprema:

- KOFER ZA PROVERU PNEUMATSKE KOČIONE INSTALACIJE
- KOFERI SA DIJAGNOSTIČKOM OPREMOM
- PAKETI DIJAGNOSTIČKIH PROGRAMA

WABCO SD - OPREMA

• Kofer za dijagnostiku pneumatske kočione instalacije



W: 435 002 007 0
R: KOCN1763

• Kofer za dijagnostiku prikoličnih sistema **W: 446 301 023 0** **R: KOCN0837**

Sadržaj kofera za dijagnostiku sistema na prikolicama i poluprikolicama:

- Diagnostic Interface
- Trailer Standardkabel
- CAN Adapter
- CAN Adapterkabel
- VCS I
- VCS II
- TEBS C / D



• Kofer za dijagnostiku sistema na kamionima **W: 446 301 025 0** **R: KOCN1764**

Sadržaj kofera za dijagnostiku sistema na kamionima:

- Adapter 35-pol EPS
- Kabel MB Actros/Citaro
- Kabel EBS Euro Neoplan
- Kabel MAN-TGA
- Kabel EBS IVECO Stralis
- Kabel ABS-D
- Kabel EBS DAF
- Kabel Actros MPII (OBD II)
- Kabel ECAS
- Kabel 15-pol. DAF, Scania, MAN (OBD II)
- Kabel ABS D/E ISO 9141



• Kofer za dijagnostiku sistema na autobusima **W: 446 301 026 0** **R: KOCN1765**

Sadržaj kofera za dijagnostiku sistema na autobusima:

- Diagnostic Interface
- Kabel MB Actros/Citaro
- Kabel EBS Euro Neoplan
- Kabel MAN-TGA
- Kabel Setra NF 315 MTS
- Kabel Actros MPII (OBD II)
- Kabel 15-pol. DAF, Scania, MAN (OBD II)



• Paketi dijagnostičkih programa:

- PAKET FULL (KAMIONI, AUTOBUSI, PRIKOLICE) **W: 246 301 900 0**
R: OPRE0098
- PAKET PRIKOLICA - POLUPRIKOLICA **W: 246 301 901 0**
R: OPRE0524
- PAKET AUTOBUSI **W: 246 301 902 0**
R: OPRE0525
- PAKET KAMIONI **W: 246 301 904 0**
R: OPRE0526



RAPIDEX TRADE svake godine u saradnji sa WABCO-m organizuje **OBUKU - TRENING** za servisere WABCO sistema.

Obuka se odvija u **EDUKATIVNOM CENTRU** u Novom Sadu, Novosadski put 160.

Do sada je obuku uspešno završilo nekoliko generacija polaznika, koje se uspešno nose sa svakodnevnim problemima kvarova na vozilima širom Srbije i zemalja u okruženju.

Predavač WABCO TRENER gospodin Berislav Babić



Detalji sa obuke u edukativnom centru



- **PROIZVODI i REŠENJA** za komercijalna vozila
- **PRIMENA** za proizvodnju vozila
- **ORIGINALNI KVALITET** za Popravku

4.0 KOMPONENTE KOČIONOG SISTEMA

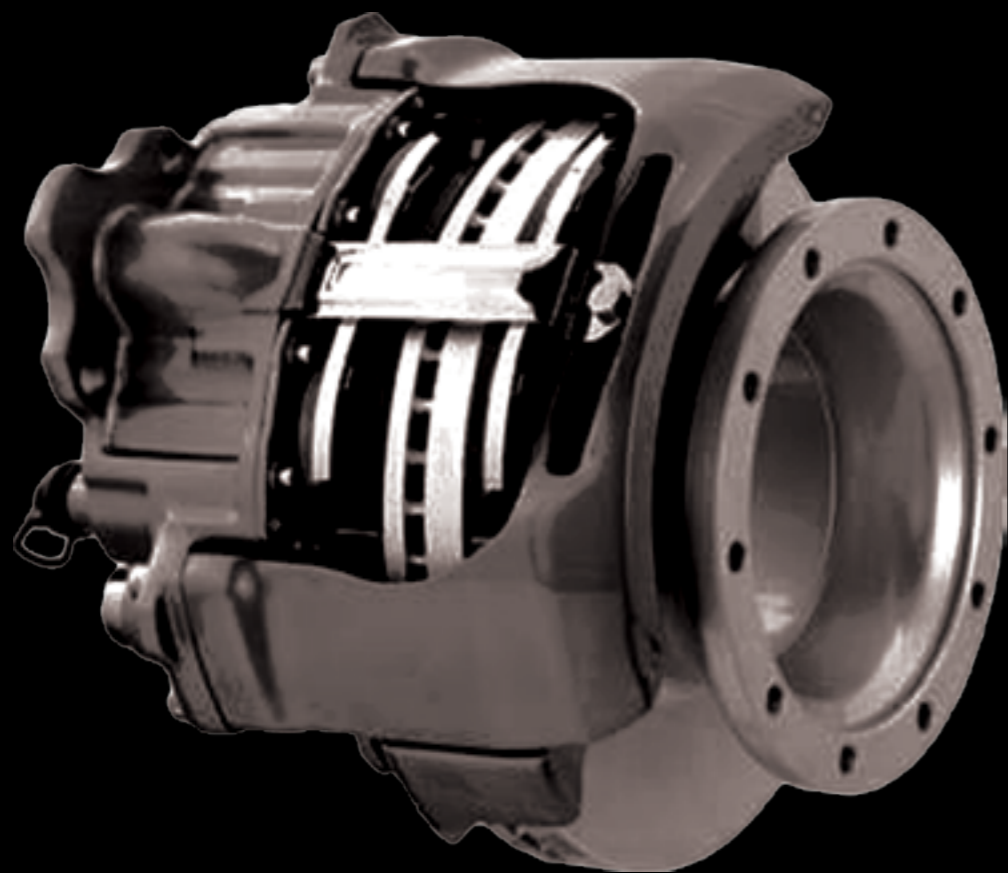

4.0 KOMPONENTE KOČIONOG SISTEMA

4.1	Disk kočnica	126
4.2	Kočione pločice	132
4.3	Čeljusti kočnica	136
4.4	Doboši kočnica	137
4.5	Kočione obloge	138
4.6	Šteleri kočnica	140
4.7	Glavčine točka, ležajevi i semerinzi	142
4.8	Vijci i navrtke	147

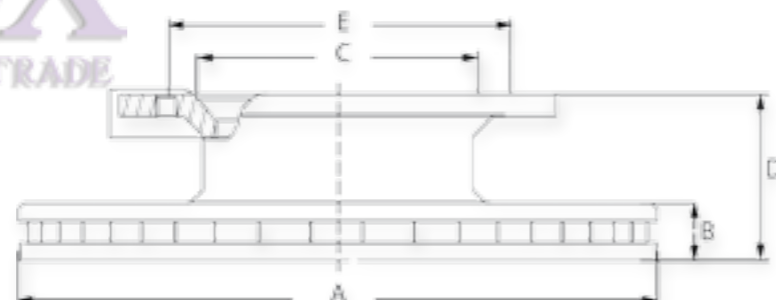

DISK KOČNICA								
	Poz.	Model	OE broj			RAPIDEX broj		
	1.	Vito 96-03	638 421 01 12			KOCN0732		
A (mm)	Bmin (mm)	Bmax (mm)	C (mm)	D (mm)	E (mm)	Rupe	Pozicija	
276	19	22	67	60	112	5 x Ø15 mm 1 x Ø9 mm	Zd	

	Poz.	Model	OE broj			RAPIDEX broj		
	2.	Vario 89-409, 508-711	669 421 06 12			KOCN1094		
A (mm)	Bmin (mm)	Bmax (mm)	C (mm)	D (mm)	E (mm)	Rupe	Pozicija	
304	26	30	118	91	140	6 x M12 x 1,5 mm	Zd	

	Poz.	Model	OE broj			RAPIDEX broj		
	3.	Vario 96-810-813	668 423 05 12			KOCN2226		
A (mm)	Bmin (mm)	Bmax (mm)	C (mm)	D (mm)	E (mm)	Rupe	Pozicija	
324	27	30	120	121	192	6 x M12 x 1,5 mm	Zd	

DISK KOČNICA								
	Poz.	Model	OE broj			RAPIDEX broj		
	4.	Sprinter 95-06 208-216	901 423 06 12			KOCN0876		
A (mm)	Bmin (mm)	Bmax (mm)	C (mm)	D (mm)	E (mm)	Rupe	Pozicija	
258	10	12	85	97	130	5 x Ø15 mm	Zd	

	Poz.	Model	OE broj			RAPIDEX broj		
	5.	Sprinter 00-06 308-316	902 423 01 12			KOCN0754		
A (mm)	Bmin (mm)	Bmax (mm)	C (mm)	D (mm)	E (mm)	Rupe	Pozicija	
272	14	16	85	97	130	5 x Ø15 mm	Zd	

	Poz.	Model	OE broj			RAPIDEX broj		
	6.	Sprinter 00-06 208-216, 308-316, 408-416	902 421 06 12			KOCN1089		
A (mm)	Bmin (mm)	Bmax (mm)	C (mm)	D (mm)	E (mm)	Rupe	Pozicija	
276	19	22	85	77	130	5 x Ø15 mm	Zd	

	Poz.	Model	OE broj			RAPIDEX broj		
	7.	Sprinter 99- Vito	638 423 01 12			KOCN0755		
A (mm)	Bmin (mm)	Bmax (mm)	C (mm)	D (mm)	E (mm)	Rupe	Pozicija	
280	8	10	67	63	112	5 x Ø15 mm 1 x Ø9 mm	Zd	

DISK KOČNICA								
	Poz.	Model	OE broj			RAPIDEX broj		
	8.	Sprinter 99-06 411-416	904 423 02 12			KOCN1958		
A (mm)	Bmin (mm)	Bmax (mm)	C (mm)	D (mm)	E (mm)	Rupe	Pozicija	
285	19	22	122	93	146	6 x Ø15 mm	Zd/Pr	
	Poz.	Model	OE broj			RAPIDEX broj		
	9.	Sprinter 06- 211-219, 310-319, 410-418	906 423 00 12			KOCN3232		
A (mm)	Bmin (mm)	Bmax (mm)	C (mm)	D (mm)	E (mm)	Rupe	Pozicija	
298	14	16	85	71	130	6 x Ø15 mm 1 x Ø9,2 mm	Zd	
	Poz.	Model	OE broj			RAPIDEX broj		
	10.	Sprinter 06- 211-219, 310-319, 410-418	906 421 00 12			KOCN3231		
A (mm)	Bmin (mm)	Bmax (mm)	C (mm)	D (mm)	E (mm)	Rupe	Pozicija	
300	25	25	85	65,5	130	6 x Ø15 mm 1 x Ø9,2 mm	Pr	
	Poz.	Model	OE broj			RAPIDEX broj		
	11.	Atego 98- 917-925, 1017-1023	970 423 02 12			KOCN1378		
A (mm)	Bmin (mm)	Bmax (mm)	C (mm)	D (mm)	E (mm)	Rupe	Pozicija	
330	30	34	145	130	177	8 x M12 x 1,5 mm	Zd	

DISK KOČNICA								
	Poz.	Model	OE broj			RAPIDEX broj		
	12.	Atego 98- 712-717, 812-824, 914-924, 1017-1023	970 423 05 12			KOCN0528		
A (mm)	Bmin (mm)	Bmax (mm)	C (mm)	D (mm)	E (mm)	Rupe	Pozicija	
335	28	34	152	111	177	10 x M12 x 1,75 mm	Zd	
	Poz.	Model	OE broj			RAPIDEX broj		
	13.	Atego 98- 812-824, 916-924, 1017-1024	970 421 06 12			KOCN0529		
A (mm)	Bmin (mm)	Bmax (mm)	C (mm)	D (mm)	E (mm)	Rupe	Pozicija	
335	28	34	92	102	120	10 x Ø14,5 mm	Pr	
	Poz.	Model	OE broj			RAPIDEX broj		
	14.	Atego 98- 812-824, 915-924, 1017-1024	970 423 06 12			KOCN0526		
A (mm)	Bmin (mm)	Bmax (mm)	C (mm)	D (mm)	E (mm)	Rupe	Pozicija	
335	28	34	145	111	117	8 x M12 x 1,5 mm	Zd	
	Poz.	Model	OE broj			RAPIDEX broj		
	15.	Atego 98- 914-923, 1015-1024, 1226-1229, 1318-1529	975 421 01 12			KOCN0810		
A (mm)	Bmin (mm)	Bmax (mm)	C (mm)	D (mm)	E (mm)	Rupe	Pozicija	
377	37	45	106	134	138	14 x Ø14,5 mm	Pr	

DISK KOČNICA								
	Poz.	Model	OE broj			RAPIDEX broj		
	16.	Atego 98-1214-1225, 1317-1528	975 423 06 12			KOCN0134		
A (mm)	Bmin (mm)	Bmax (mm)	C (mm)	D (mm)	E (mm)	Rupe	Pozicija	
377	37	45	176	138	201	8 x M14 x 1,5 mm	Zd	

	Poz.	Model	OE broj			RAPIDEX broj		
	17.	Actros MP I, MP II, MP III, Axor	942 421 11 12			KOCN0940		
A (mm)	Bmin (mm)	Bmax (mm)	C (mm)	D (mm)	E (mm)	Rupe	Pozicija	
430	37	45	211	133	238	10 x M14 x 1,5 mm	Pr/Zd	











	Poz.	Model	OE broj			RAPIDEX broj		
	18.	Actros MP II 03-Axor 04-	943 421 03 12			KOCN0056		
A (mm)	Bmin (mm)	Bmax (mm)	C (mm)	D (mm)	E (mm)	Rupe	Pozicija	
430	37	45	199	143	168	10 x Ø21 mm 2 x M12 x 1,5 mm	Pr/Zd	











	Poz.	Model	OE broj			RAPIDEX broj		
	19.	Tourismo, O404	356 421 10 12			KOCN0906		
A (mm)	Bmin (mm)	Bmax (mm)	C (mm)	D (mm)	E (mm)	Rupe	Pozicija	
438	41	45	195	135	235	10 x M14 x 1,5 mm	Pr/Zd	

DISK KOČNICA								
	Poz.	Model	OE broj			RAPIDEX broj		
	20.	Unimog	440 421 01 12			KOCN2130		
A (mm)	Bmin (mm)	Bmax (mm)	C (mm)	D (mm)	E (mm)	Rupe	Pozicija	
421	17	22	145	62	180	8 x Ø15 mm	Pr/Zd	

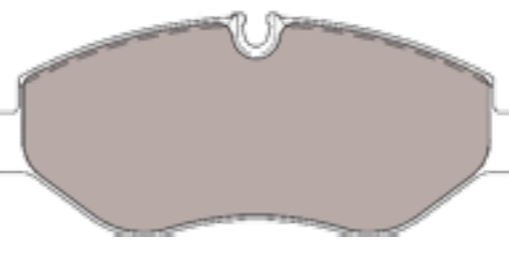
DISK KOČNICA - OSOVINA								
	Poz.	Model	OE broj			RAPIDEX broj		
	21.	MB osovina prikolica	675 421 00 12			KOCN0057		
A (mm)	Bmin (mm)	Bmax (mm)	C (mm)	D (mm)	E (mm)	Rupe	Pozicija	
377	37	45	211	132	238	10 x M14 x 1,5 mm	-	



KOČIONE PLOČICE						
	WVA broj		Dimenzije (mm)			RAPIDEX broj
		23021	Teves	125,8	61,9	18,9
	Poz.	Model			OE broj	
	1.	SPRINTER 308-317, 408-416			000 420 97 20	
	WVA broj		Dimenzije (mm)			RAPIDEX broj
	23901	Teves	156,3	55,4	18,8	KOCN1448
	Poz.	Model			OE broj	
	2.	SPRINTER 208-214, 308-316, 408-416			004 420 61 20	
	WVA broj		Dimenzije (mm)			RAPIDEX broj
	23990	Teves	156,5	64,8	20,7	KOCN2160
	Poz.	Model			OE broj	
	3.	SPRINTER 208-216, 308-316, VITO 108-114			004 420 55 20	
	WVA broj		Dimenzije (mm)			RAPIDEX broj
	29148	Knorr	185	84	34	KOCN1035
	Poz.	Model			OE broj	
	4.	ATEGO 712-718, 812-817, 914-923, 1014-1224			004 420 61 20	
	WVA broj		Dimenzije (mm)			RAPIDEX broj
	29153	Perrot	164,7	73	20	KOCN3177
	Poz.	Model			OE broj	
	5.	SPRINTER 408-416			004 420 24 20	

KOČIONE PLOČICE						
	WVA broj		Dimenzije (mm)			RAPIDEX broj
		29165 29095	Knorr	210,8	92,5	30
	Poz.	Model			OE broj	
	6.	ATEGO 715-718-1015-1224			000 421 50 10	
	WVA broj		Dimenzije (mm)			RAPIDEX broj
	29190	Bosch	137	63	19	KOCN0394
	Poz.	Model			OE broj	
	7.	SPRINTER 209-224, 309-324 413-424, 509-524			004 420 69 20	
	WVA broj		Dimenzije (mm)			RAPIDEX broj
	29192	Brembo	163,3	67,1	20,9	KOCN2016
	Poz.	Model			OE broj	
	8.	SPRINTER 209-218, 309-319, VITO 109-126			005 420 52 20	
	WVA broj		Dimenzije (mm)			RAPIDEX broj
	29200	Brembo	169,3	73,5	20,9	KOCN2901
	Poz.	Model			OE broj	
	9.	SPRINTER 413-419, 509-519			005 420 53 20	
	WVA broj		Dimenzije (mm)			RAPIDEX broj
	29202	Knorr	247,3	109,5	30	KOCN0875
	Poz.	Model			OE broj	
	10.	ATEGO, AXOR, ACTROS			004 420 60 20	

KOČIONE PLOČICE						
WVA broj		Dimenzije (mm)			RAPIDEX broj	
		29217	Bosch	165		79
Poz.	Model			OE broj		
11.	SPRINTER 413-424, 509-524			004 420 81 20		
WVA broj		Dimenzije (mm)			RAPIDEX broj	
29244	Knorr	207,6	113,7	35	KOCN3193	
Poz.	Model			OE broj		
12.	ACTROS MP IV 07/11-			006 420 15 20		
WVA broj		Dimenzije (mm)			RAPIDEX broj	
29246	Knorr	244,6	113,7	35	KOCN3192	
Poz.	Model			OE broj		
13.	ACTROS MP IV 07/11-			006 421 42 00		
WVA broj		Dimenzije (mm)			RAPIDEX broj	
29835	Teves	175	85	22	KOCN0554	
Poz.	Model			OE broj		
14.	VARIO			003 420 77 20		

SENZORI ISTROŠENOSTI PLOČICA					
Slika	Poz.	Model	Dimenzije	OE broj	RAPIDEX broj
	1.	SPRINTER 06-, 208-217, 309-318, 412-418, 512-524	189 mm	901 540 02 17	KOCN2633
	2.	SPRINTER 06-, 208-217, 309-318, 412-418, 512-524	103 mm	906 540 14 17	KOCN2635
	3.	SPRINTER 00-06 208-216, 308-316	210 mm	901 540 00 17	KOCN0842
	4.	SPRINTER 06- 309-319, 413-424, 509-524	95 mm	639 540 14 17	KOCN2634
	5.	SPRINTER, VARIO 96- 618-625	214 mm	669 540 04 17	KOCN0841
	6.	SPRINTER 618, VARIO 618	214 mm	669 540 05 17	KOCN1198
	7.	SPRINTER 616, VARIO	185 mm	669 540 07 17	KOCN0840



ČELJUSTI

Poz.	Model	Tip čeljusti	Proizvođač	KBP	OE broj	RAPIDEX broj
1.	SPRINTER	244 V-O	WABCO	40 244 010	904 420 09 01	KOCN2081
2.	SPRINTER	244 V-O	WABCO	40 244 009	904 420 08 01	KOCN2080
3.	VARIO	16	MERITOR	LRG624	001 420 34 01	KOCN0262
4.	VARIO	16	MERITOR	LRG625	001 420 35 01	KOCN0263
5.	ATEGO	17,5	KNORR	SN5016/SB5013	970 420 21 01	KOCN0737
6.	ATEGO	17,5	KNORR	SB5003/K004572	970 420 05 01	KOCN0637
7.	ATEGO	19,5	KNORR	SN6567RC/K003792	002 240 44 01	KOCN1401
8.	ATEGO	19,5	KNORR	SN6867/K003794	002 240 43 01	KOCN3403
9.	ACTROS	22,5	KNORR	SN7201/K00799	942 420 42 01	KOCN0898
10.	ACTROS	22,5	KNORR	SN7211/K003800	942 420 16 01	KOCN1404
11.	UNIMOG	1300 V-G	WABCO	40 130 007	-	KOCN1985
12.	UNIMOG	1300 V-G	WABCO	40 130 008	-	KOCN1986

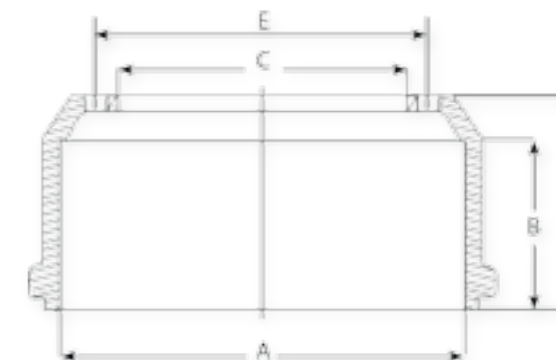

DOBOŠI KOČNICA

Poz.	Model	A (mm)	B (mm)	C (mm)	D (mm)	E (mm)	Rupe	Pozicija	OE broj	RAPIDEX broj
1.	Atego 817, 914-917, 1120, 1314-1317	360	142	238	198	275	8 x Ø23 mm	Pr	677 421 04 01	KOCN0966
2.	Atego 1114-1120, 1314-1320	364	171	238	210	275	8 x Ø23 mm 3 x M12	Pr	677 421 05 01	KOCN1266
3.	NG 3028-3544, Atego 1418-1419,	410	175	238	298	335	10 x Ø23 mm	Pr/Zd	301 423 01 01	KOCN0931
4.	MK 1613-1644, SK 1922-2644, Actros MP I, MP II	410	193	298	280	335	10 x Ø23 mm	Zd	346 423 01 01	KOCN1359
5.	SK 1613-1644, 1717-1748, Actros MP I	410	238	298	306	335	10 x Ø23 mm, 5 x Ø24 mm 3 x M12 x 1,5 mm	Zd	305 423 03 01 305 423 04 01	KOCN1135
6.	MK 1613-1644, 1717-1748, SK 1820-1853, 199-194	410	191	298	236	335	10 x Ø23 mm 3 x M12 x 1,5 mm	Pr	685 421 00 01 624 421 02 01	KOCN3162
7.	MK, SK 1613-1644, 1717-1748, 1820-1853, 1922-1948, BUS O303, O307, O405	410	238	298	306	335	10 x Ø23 mm 3 x M12 x 1,5 mm	Zd	301 423 08 01 387 421 00 21	KOCN1092
8.	SK 1924, 2026-2626	410	172	298	270	335	10 x Ø23 mm	Zd	346 423 06 01	KOCN0424
9.	MK 1613-1644, 2717-1748, 1820-1853, 1922-1948	410	166	298	213	335	10 x Ø23 mm 3 x M12 x 1,5 mm	Pr/Zd	305 421 01 01	KOCN3100
10.	MK 1419-1621, SK 2632	410	172	298	280	335	10 x Ø23 mm	Zd	381 423 00 01	KOCN2794
11.	MK 1613-1619, BUS O303	410	172	298	228	335	10 x Ø23 mm	Pr	305 421 00 01	KOCN3218



MK, ATEGO

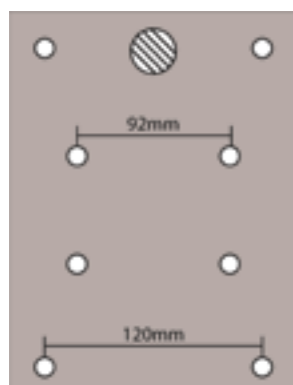

WVA broj					OE broj	RAPIDEX broj
19494	410	163	178	8	617 423 18 30	
19494 170008						KOCN0390
19494 183008						KOCN0391
19494 191008						KOCN0392
Model						
MK 1222-1831, ATEGO 1017-1528, ATEGO 2						

MK, ATEGO, ACTROS

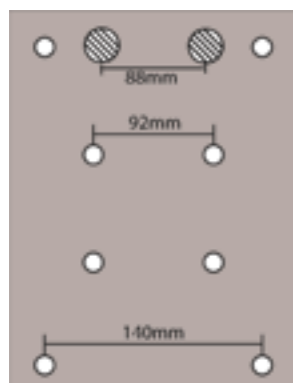

WVA broj					OE broj	RAPIDEX broj
19495	410	183	178	8	659 423 40 10	
19495 170008						KOCN0356
19495 183008						KOCN0357
19495 191008						KOCN0358
Model						
MK, SK 1838-3544, ATEGO 1017-1823, ACTROS MP I, MP II						

SK, ATEGO, AXOR, ACTROS

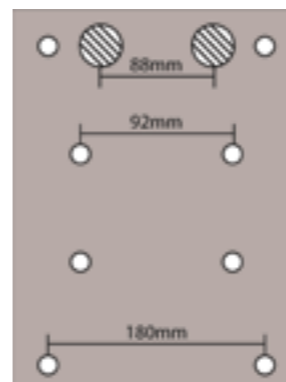

WVA broj					OE broj	RAPIDEX broj
19496	410	223	178	8	659 423 36 10	
19496 170008						KOCN1176
19496 183008						KOCN0355
19496 191008						KOCN0224
Model						
SK 1823, ATEGO 1823, ACTROS MP I, MP II, AXOR						

SK 1823, ATEGO 1823, ACTROS MP I, MP II, AXOR

BUS CONECTO

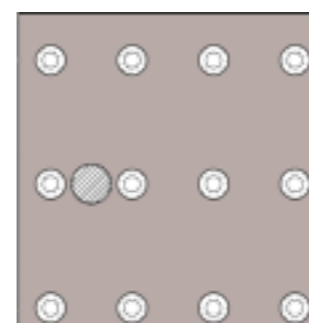









WVA broj					OE broj	RAPIDEX broj
19699	410	220	174,3	8	000 421 01 03	
19699 175505						KOCN3124
19699 185505						KOCN3272
Model						
BUS CONECTO						

NITNE ZA OBLOGE



Model	Dimenzije	Set	KBP	RAPIDEX broj
SVI MODELI	Ø8 x 18 mm	100 kom	96000 0045	KOCN0388

ŠTELERI KOČNICA							
Slika	Poz.	Model	Broj zuba	Oso rastojanje (mm)	Haldex broj	OE broj	RAPIDEX broj
	1.	NG, SK, BUS O303	26	145	79203C	307 420 02 38	KOCN0716
	2.	NG, SK, BUS O303	26	145	79204C	307 420 01 38	KOCN0715
	3.	MK, SK, BUS	20	145	79637C	000 352 08 40	KOCN3164
	4.	MK, SK, BUS	20	145	79638C	000 352 09 40	KOCN3163
	5.	MK, NG, ATEGO, AXOR, ACTROS	26	145	80000C	942 420 02 38	KOCN1478

ŠTELERI KOČNICA							
Slika	Poz.	Model	Broj zuba	Oso rastojanje (mm)	Haldex broj	OE broj	RAPIDEX broj
	6.	MK, NG, ATEGO, AXOR, ACTROS	26	145	80001C	942 420 03 38	KOCN1411
	7.	MK, NG, ATEGO, AXOR, ACTROS	26	145	80008C	942 420 09 38	KOCN1078
	8.	MK, NG, ATEGO, AXOR, ACTROS	26	145	80009C	942 420 08 38	KOCN1477



GLAVČINE TOČKA

Poz.	Model	OE broj	RAPIDEX broj
1.	ATEGO 713-718	972 330 03 25	OSOV0412
2.	ATEGO 713-718	972 334 02 01	OSOV0965
3.	ATEGO 1013-1024	972 356 02 01	VESA0020
4.	ATEGO 1013-1024	976 356 11 01	OSOV0967
5.	ATEGO 814-817	975 330 04 25	OSOV0640
6.	AXOR, ACTROS MP I	943 330 11 25	OSOV0968
7.	AXOR, ACTROS MP I, MP II/MP III	942 334 12 01	OSOV0277
8.	ACTROS MP I, AXOR	385 356 14 01	OSOV0048
9.	ATEGO I, II, AXOR, ACTROS MP I, MP II/MP III	946 356 02 01	OSOV0969

LEŽAJEVI

Poz.	Model	Dimenzije (mm)			KBP	OE broj	RAPIDEX broj
1.	SPRINTER 208-216, 308-316, 408-416, 95-06	73,4	41,27	20	VKHB2153	001 980 62 02	OSOV0097
2.	SPRINTER 208-216, 308-316, 408-416, 95-06	73,5	41	19,5	VKBA6686 SET	901 330 10 25	OSOV0628
3.	SPRINTER 208-216, 308-316, 408-416, 95-06	52	25	19,5	VKBA3434	611 330 08 25	OSOV0055
4.	ATEGO I 98-04	72	30	28,75	32306A VKHB2007	000 981 95 05	OSOV0234
5.	ATEGO I, II, 04-	130	78	90	803194 VKBA5415	013 981 98 05	OSOV0072
6.	ATEGO I, II, 04-	140	82	115	VKBA5412	016 981 28 05	OSOV0095
7.	ATEGO I, II, 04 -	140	90	32	32018 VKHB2170	004 981 17 05	OSTA0081
8.	ATEGO I, II, BUS O303-O404	150	100	39	33020 VKHB2124	006 981 01 05	OSTA1025
9.	ATEGO I, II, 98- ACTROS	108	60	75	201050	015 981 19 05	OSOV0874
10.	ATEGO I, AXOR, ACTROS MP I	130	80	37	33116 VKHB2177	012 981 40 50	OSOV0182

LEŽAJEVI

Poz.	Model	Dimenzije (mm)			KBP	OE broj	RAPIDEX broj
11.	ATEGO I, AXOR, ACTROS MP I	160	105	43	33021 VKHB2162	005 981 49 05	OSOV0415
12.	ATEGO I, ACTROS MP I	110	50	42,25	32310 VKHB2070	001 981 76 05	OSOV0219
13.	ATEGO I, AXOR, ACTROS MP I	120	65	41	33213 VKHB2007	003 981 37 05	OSOV0234
14.	AXOR II 04- ACTROS MP I, MP II/MP III -	150	70	64	VKHB2280 BT1-0084/Q	013 981 42 05	OSOV0208
15.	AXOR II 04- ACTROS MP I, MP II/MP III, BUS CITARO	130	60	48,5	VKHB2003	011 981 68 05	OSOV0209
16.	AXOR II, 04- ACTROS MP I, MP II/MP III	170	110	47	VKHB2163	008 981 35 05	OSOV0423
17.	AXOR II, 04- ACTROS MP I, MP II/MP III, BUS TRAVEGO	157	100	43,5	VKHB2329	011 981 23 05	OSOV0427
18.	AXOR II, 04- ACTROS MP I, MP II/MP III	140	82	115	805003A.H195	014 981 99 05	OSOV0745
19.	AXOR II, 04- ACTROS MP I, MP II/MP III	160	100	44	805312	015 981 48 05	OSOV0519
20.	AXOR II, 04- ACTROS MP I, MP II/MP III	150	70	64	201069	013 981 42 05	OSOV0429
21.	AXOR II, 04- ACTROS MP I, MP II/MP III	120	55	45,5	32311 VKHB2002	006 981 08 05	OSOV0196
22.	ACTROS MP II/MP III	160	106	35	528595 VKBA2172	001 980 25 02	OSOV0424
23.	AXOR II, ACTROS MP II/MP III	150	100	32	30020X VKBA2306	001 981 64 05	OSOV0428
24.	BUS O303	140	80	35,25	32216 VKHB2033	000 981 03 05	OSOV0771
25.	BUS O303, O404	90	50	32	33210	003 981 83 05	OSOV0043

SEMERINZI

Poz.	Model	Dimenzije (mm)			OE broj	RAPIDEX broj
1.	ATEGO 98-	125	150	14	022 997 52 47	OSOV0714
2.	ATEGO 1225-1525	86	105	5/6	012 997 08 46	OSOV0748
3.	ATEGO 1, 2	78	135	12/21,5	015 997 47 47	MENJ0087
4.	ATEGO 98-	115	140	13	010 997 78 47	OSOV0502
5.	ATEGO 98- ACTROS	120	150	14,3/20	021 997 69 47	OSOV0552
6.	NK, SK, ACTROS MP I	85	145	12/37	015 997 47 47	OSOV0455
7.	NG, SK, ACTROS MP I	145	175	14	016 997 56 47	OSTA0300
8.	ATEGO, ACTROS MP I, ACTROS MP II/MP III	145	175	15	013 997 35 46	MENJ0710
9.	ATEGO, AXOR, ACTROS MP I, ACTROS MP II	145	175	17/21	020 997 39 47	OSTA0237
10.	SK, MK, NG, ACTROS	145	175/205	18/20	020 997 05 47	OSOV0705

SEMERINZI						
Poz.	Model	Dimenzije (mm)			OE broj	RAPIDEX broj
11.	MK, SK, ACTROS MP I, ACTROS MP II/MP III	110	145	32	355 356 12 15	OSOV0135
12.	AXOR 2, ACTROS MP I, ACTROS MP II	145	175	13	013 997 94 47	OSTA0307
13.	AXOR 2, ACTROS MP I, ACTROS MP II/MP III	145	175/205	9	015 997 49 47	OSOV0672
14.	ACTROS MP II/MP III	145	175	16	013 997 22 40	OSOV0706
15.	ACTROS MP I, ACTROS MP II/MP III	145	175	8	014 997 05 46	MENJ0709
16.	ACTROS MP I, ACTROS MP II/MP III	115	145	32	942 356 04 15	MOTO0330
17.	ACTROS MP I, ACTROS MP II/MP III	119	145	26	946 356 00 15	OSTA0294
18.	ACTROS MP I, ACTROS MP II/MP III	SET			940 350 08 35	OSOV0710
19.	ACTROS MP I, ACTROS MP II/MP III	SET			940 350 06 35	OSOV0954
20.	ACTROS MP I, ACTROS MP II/MP III	SET			624 356 00 80	OSOV0709
21.	ACTROS MP II/MP III	SET			940 350 00 35	MENJ0249
22.	ACTROS MP II, TOURISMO O403	SET			942 350 39 35	OSOV0195



VIJCI I NAVRTKE								
Poz.	Model	Naziv	Dimenzije (mm)			Navoj (mm)	OE broj	RAPIDEX broj
1.	SPRINTER	VIJAK	64	57	26	M14 x 1,5	309 420 02 71	VESA1675
		NAVRTKA				M14 x 1,5	074361014202	VESA1676
2.	SPRINTER	VIJAK	62	55	34	M14 x 1,5	601 401 02 70	OSOV0858
		NAVRTKA				M14 X 1,5	074361014202	VESA1676
3.	ATEGO	VIJAK	73	65	30,5	M18 x 1,5	318 402 00 71	OSOV0843
		NAVRTKA				M18 x 1,5	074361018205	OSOV0223
4.	ATEGO	VIJAK	92	84	35	M20 x 1,5	302 402 00 71	OSOV0836
		NAVRTKA				M20 x 1,5	074361018205	OSOV0223
5.	ACTROS	VIJAK	108,5	98	38	M22 x 1,5	381 401 05 71	OSOV0345
		NAVRTKA				M22 x 1,5	385 400 01 24	OSOV0225
6.	ACTROS	VIJAK	115,5	105	39	M22 x 1,5	355 401 00 71	OSOV0346
		NAVRTKA				M22 x 1,5	385 400 01 24	OSOV0225
7.	ACTROS	VIJAK	87,5	77	38	M22 x 1,5	381 401 01 71	OSTA0251
		NAVRTKA				M22 x 1,5	385 400 01 24	OSOV0225
8.	ACTROS	VIJAK	120,5	110	75	M22 x 1,5	381 401 07 01	OSOV0829
		NAVRTKA				M22 x 1,5	385 400 01 24	OSOV0225
9.	ACTROS	VIJAK	78,5	68	38	M22 x 1,5	942 401 03 71	OSOV0834
		NAVRTKA				M22 x 1,5	385 400 01 24	OSOV0225
10.	ACTROS	VIJAK	99,5	88	37	M22 x 1,5	381 401 03 71	OSOV0841
		NAVRTKA				M22 x 1,5	385 400 01 24	OSOV0225
11.	ACTROS	VIJAK	91	80,5	39	M22 x 1,5	389 401 00 71	OSOV0844
		NAVRTKA				M22 x 1,5	385 400 01 24	OSOV0225
12.	ACTROS	VIJAK	120,5	110	38	M22 x 1,5	346 401 01 71	OSOV0829
		NAVRTKA				M22 x 1,5	385 400 01 24	OSOV0225

5.0 ELEMENTI OGIBLJENJA I UPRAVLJANJA

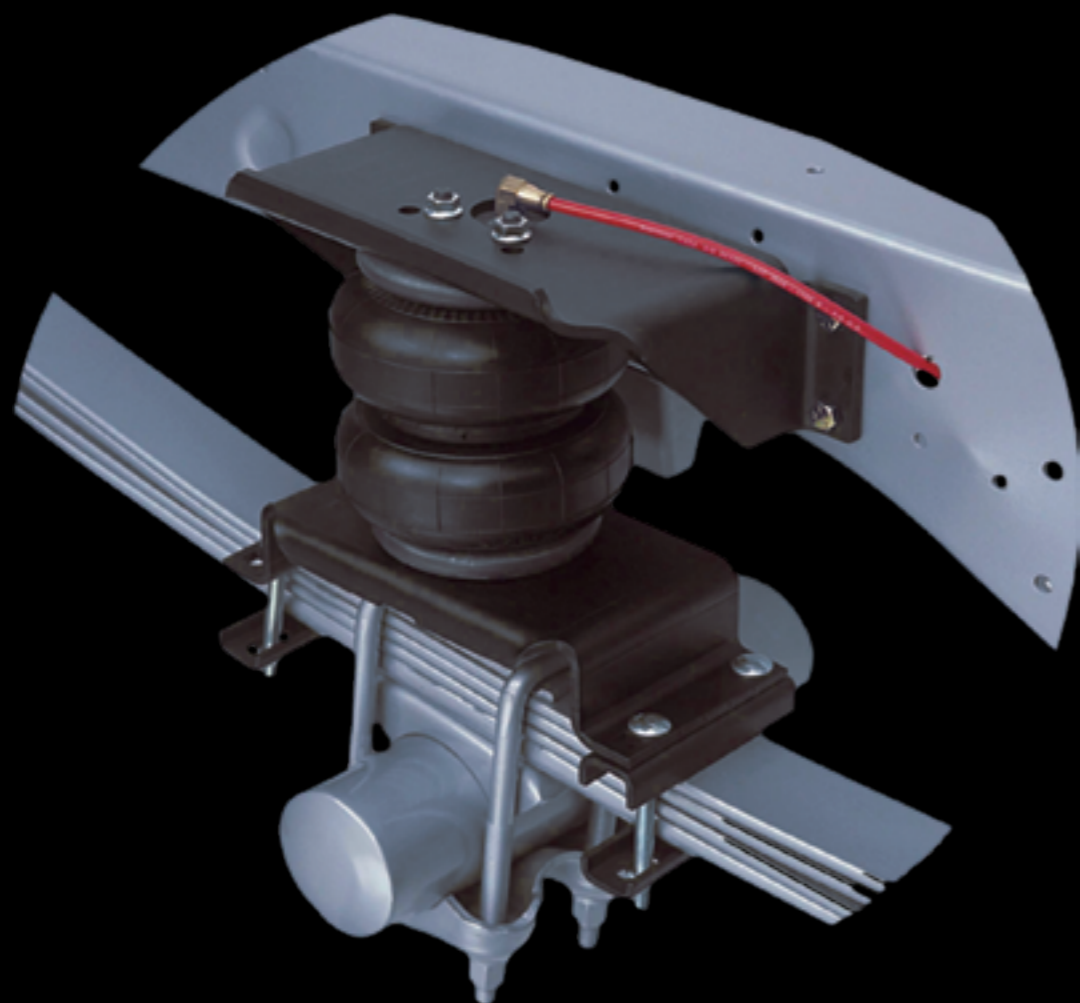

5.0 ELEMENTI OGIBLJENJA I UPRAVLJANJA

5.1	Amortizeri	150
5.2	Vazdušni jastuci	157
5.3	Gibnjevi	166
5.4	Delovi stabilizatora	174
5.5	Delovi rukavca	177
5.6	Spone i delovi spona	179
5.7	Uporne spone	184
5.8	V spone	185

AMORTIZERI - TIPOVI VEZA

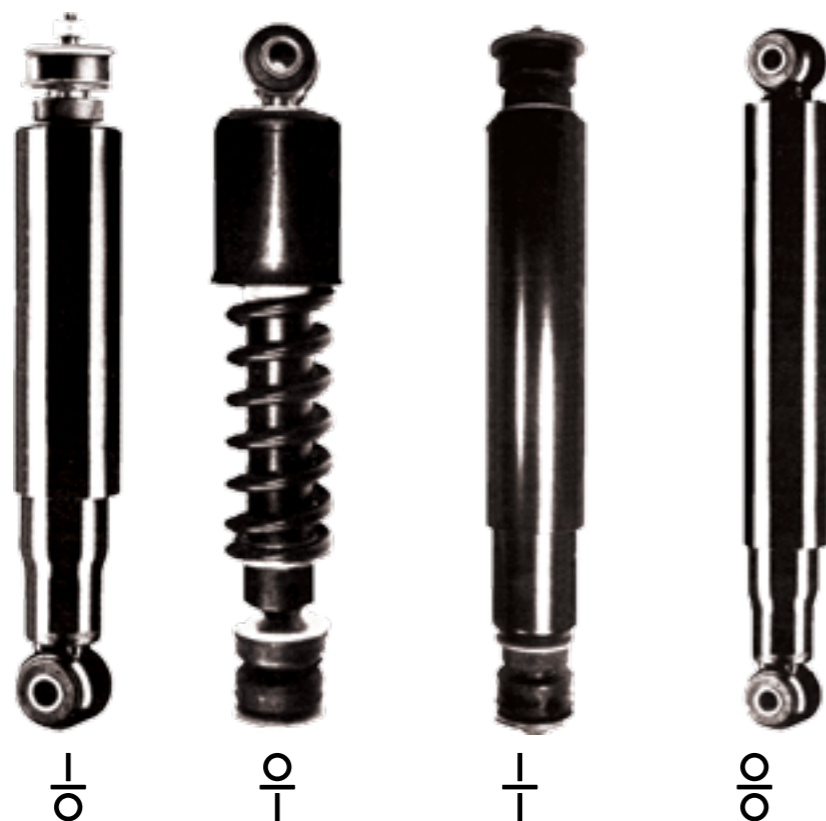

LEGENDA:

SIMBOL	ZNAČENJE	SIMBOL	ZNAČENJE
	VEZA OKO - OKO		AMORTIZER PREDNJE OSOVINE
	VEZA OKO - VIJAK		AMORTIZER ZADNJE OSOVINE
	VEZA VIJAK - OKO		PREDNJA I ZADNJA OSOVINA
	VEZA VIJAK - VIJAK		AMORTIZER KABINE - PREDNJI
	VEZA OKO - VILJUŠKA		AMORTIZER KABINE - ZADNJI
	AMORTIZER VOLANA		AMORTIZER KABINE



AMORTIZERI

Poz.	Model	Osovina	Tip veze	OE broj	Sachs broj	RAPIDEX broj
1.	709, 809, 814, 914K, 914KO			005 326 29 00	106 832	AMOR0234
2.	812, 813, 815, 609, 709DK, 711D, 809D, 811, 814			004 326 13 00	310 775	AMOR0231
3.	709, 711, 809, 814, 817, 914, 917			006 323 28 00	310 771	AMOR0209
4.	512, 812, 507, 508, 510, 609, 709, 711, 809, 811, 814			004 323 88 00	112 370	AMOR0214
5.	814, MK, SK, 16-30 t			006 323 09 00	310 789	AMOR0501
6.	MK, SK, 12-30 t			002 323 86 00	112 027	AMOR0068
7.	MK, SK, 16-25 t			002 326 88 00	310 801	AMOR0097
8.	SPRINTER 309, 311, 313, 315, 316			906 320 62 30	-	AMOR0460
9.	SPRINTER 208, 210, 212, 308, 310, 311, 314, 316, 408, 413, 416			904 320 13 30	115 901	AMOR0495
10.	SPRINTER 408, 411, 413, 414, 416			904 320 02 31	124 654	AMOR0548
11.	SPRINTER 208, 210, 212, 308, 310, 311, 314, 316			901 320 06 31	290 377	AMOR0494
12.	SPRINTER 616			905 320 00 30	310 768	VESA1162
13.	SPRINTER 616, Vario 812			905 320 02 31	106 993	VESA1161
14.	VITO 108, 114			638 320 07 13	310 016	AMOR0394
15.	VITO 109, 115, 122, 126			639 320 1513	311 645	AMOR0519
16.	VITO 109, 115, 122, 126			639 326 03 00	311 646	AMOR0520
17.	Atego, Atego 2			970 323 07 00	313 766	VESA0111

AMORTIZERI

Poz.	Model	Osovina	Tip veze	OE broj	Sachs broj	RAPIDEX broj
18.	Atego, Atego 2			970 326 00 00	311 186	VESA1232
19.	Atego 712-717			970 326 01 00	131 739	AMOR0111
20.	Atego 1215-1528			970 326 04 00	125 912	VESA1066
21.	Atego 1215-, 1317-, 1517-, 1529-			974 323 00 00	125 909	AMOR0502
22.	Atego			005 326 46 00	106 776	AMOR0516
23.	Actros			005 323 95 00	310 777	AMOR0091
24.	Actros, 1831-, 2031-, Atego 1823-, Axor			005 326 01 00	131 623	AMOR0005
25.	Actros 1831-, 2031-, Atego 1823-1828			005 326 33 00	125 908	AMOR0006
26.	Actros 1831-, 2031-, 3231-, 4140-, Atego 1823, 2628			005 323 97 00	125 898	AMOR0092
27.	Actros 1831-, 2031-, Atego 1215, Axor			006 323 51 00	131 056	AMOR0093
28.	Actros 1831-1860			006 323 84 00	290 007	AMOR0174
29.	Actros 1831-, 2531-, Atego 1823-, 2523-			006 323 33 00	124 639	AMOR0227
30.	Actros 1831-, 2531-, Atego 1823-, 2523-			005 326 12 00	124 360	AMOR0107
31.	Actros 1831-, 2031-, 2631-			005 326 25 00	124 361	AMOR0325
32.	Actros 1831-, 2031-			006 323 54 00	131 622	AMOR0459
33.	Actros 1831-, 2031-, Atego 1823-, 2523-, Axor			005 323 99 00	310 807	AMOR0422

AMORTIZERI

Poz.	Model	Osovina	Tip veze	OE broj	Sachs broj	RAPIDEX broj
34.	Actros 1831-, 2531-, 3231-, 4140-, Atego 2628			005 326 09 00	124 567	AMOR0331
35.	Axor 2, Actros MP I, MP II			006 323 34 00	310 769	AMOR0128
36.	Actros, Actros MP II			006 323 95 00	310 163	AMOR0431
37.	Atego, Axor, Axor 2, Actros MP II, Actros MP III			006 326 03 00	311 644	AMOR0451
38.	Atego, Axor, Axor 2, Actros MP II, Actros MP III			006 326 04 00	311 669	AMOR0478
39.	Econic, Actros			006 326 02 00	300 021	AMOR0489
40.	Actros 1831-1853, 2031-2653, 3331-3357			005 323 91 00	310 804	AMOR0491
41.	Actros , Actros MP II, MP III			006 326 68 00	124 638	AMOR0526



AMORTIZERI - KABINE

Poz.	Model	Mesto ugradnje	Tip veze	Sachs broj	OE broj	RAPIDEX broj
1.	LK, NG 1013-2636			101 329	387 890 16 19	AMOR0367
2.	NG, SK Serija			101 456	000 891 18 05	AMOR0080
3.	Atego 1823-1828, 2523-2528 Axor 1823-3238			135 066	940 890 08 19	AMOR0048
4.	Atego 1215, 1215L, 1517, 1517L			131 676	970 317 17 03	AMOR0264
5.	Atego 1215, 1215L, 1517, 1517L			131 726	970 317 18 03	AMOR0265
6.	Atego, Atego 2			135 180	970 317 50 03	AMOR0508
7.	Atego 1823-1828, 2523-2628, Axor 1823-3238			313 949	940 890 38 19	AMOR0424
8.	Atego 1823-1828, 2523-2628, Axor 1823-3238			290 995	940 890 39 19	AMOR0398
9.	Atego, Axor 2			290 996	940 890 46 19	AMOR0397
10.	Actros 1831-, 2031-, 2531-, 3231-, 4140-			290 997	942 890 02 19	AMOR0083
11.	Actros 1831-4148 96/06→, Atego 1823-2628			313 941	942 890 05 19	AMOR0416
12.	Actros 1831S, LS- 1853S, LS			313 676	942 890 29 19	AMOR0082
13.	Actros 1831S, LS- 1853S, LS			131 850	942 890 28 19	AMOR0109
14.	Actros 1831-, 2031-, 2531-, 3231-, 4140-			290 257	942 890 38 19	AMOR0130
15.	Actros 1831-, 2031-, 2531-, 3231-, 4140-			313 948	942 890 54 19	AMOR0203
16.	Actros 1831-, 2031-, 2531-, 3231-, 4140-			313 943	942 890 11 19	AMOR0425

AMORTIZERI - KABINE

Poz.	Model	Mesto ugradnje	Tip veze	Sachs broj	OE broj	RAPIDEX broj
17.	ACTROS 1831-, 2031-, 2531-, 3231-, 4140-			313 947	942 890 56 19	AMOR0412
18.	ACTROS 1831-, 2031-, 2531-, 3231-, 4140-			313 951	942 890 50 19	AMOR0450
19.	ACTROS 1831-, 2031-, 2531-, 3231-, 4140-			105 423	942 890 23 19	AMOR0086
20.	ACTROS 1831-, 2031-, 2531-, 3231-, 4140-			311 663	943 890 38 19	AMOR0114
21.	ACTROS MP II, MP III			311 664	942 890 61 19	AMOR0477
22.	ACTROS 1831-, 2031-, 2531-, 3231-, 4140-			313 942	942 890 04 19	AMOR0432
23.	ACTROS 1831-, 2031-, 2531-, 3231-, 4140-			313 945	942 890 36 19	AMOR0456
24.	ACTROS 1831-, 2031-, 2531-, 3231-			131 275	942 890 47 19	AMOR0085
25.	ACTROS 1831-2535			-	942 890 69 19	AMOR0116
26.	ACTROS 1831-2535			-	942 890 70 19	AMOR0117
27.	Axor 2, ACTROS MP I, MP II			312 649	943 890 50 19	AMOR0120
28.	ACTROS, ACTROS MP II, MP III			313 946	942 890 55 19	AMOR0496
29.	ACTROS MP II, MP III			313 952	943 890 30 19	AMOR0498

GASNI AMORTIZERI

Poz.	Model	Dužina L (mm)	Sila F (N)	SE-M broj	OE broj	RAPIDEX broj
1.	MK, SK	750	220	8381	000 980 90 64	AMOR0143
						
2.	AXOR	610	360	8382	001 980 84 64	AMOR0144
						



644N

	Broj proizvođača dela	OE broj	Primena / Opis	RAPIDEX broj
	Contitech 644N	307 328 00 01	EVO Bus, O404, O405, O407, O408	VESA1614
	Fabio 34644			

661N

	Broj proizvođača dela	OE broj	Primena / Opis	RAPIDEX broj
	Contitech 661N	100112250	EVO Bus, Neoplan, Kässbohrer	VESA1615
	Fabio 34661			

673N

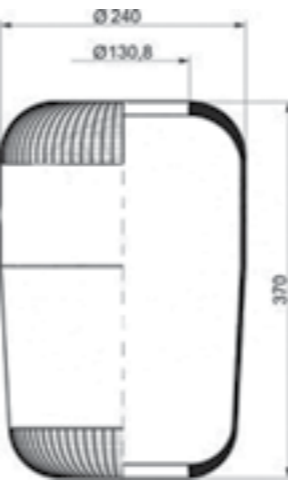
	Broj proizvođača dela	OE broj	Primena / Opis	RAPIDEX broj
	Contitech 673N	621 328 00 01	SK, različiti tipovi	VESA1731
	Fabio 34673			

757N				
	Broj proizvođača dela	OE broj	Primena / Opis	RAPIDEX broj
	Contitech 757N	363 328 02 01	MK, SK, prednja osovina	VESA1838
	Fabio 34757			

4183N1				
	Broj proizvođača dela	OE broj	Primena / Opis	RAPIDEX broj
	Contitech 4183N1	942 320 23 21	Actros MP II (jedan priključak za vazduh Voss 232)	VESA1865
	Fabio 344183-2S			

4183NP23				
	Broj proizvođača dela	OE broj	Primena / Opis	RAPIDEX broj
	Contitech 4183NP23	942 320 22 21	Actros MP II (jedan priključak za vazduh)	VESA1836
	Fabio 344183-C			

4183NP24				
	Broj proizvođača dela	OE broj	Primena / Opis	RAPIDEX broj
	Contitech 4183NP24	942 320 23 21	Actros MP II (jedan priključak za vazduh Voss 232)	VESA1790
	Fabio 344183-2C			

4185NP21				
	Broj proizvođača dela	OE broj	Primena / Opis	RAPIDEX broj
	Contitech 4185NP21	942 320 30 21	Atego (jedan priključak za vazduh Voss 232)	VESA1971
	Fabio 344185-10C			

4186NP23				
	Broj proizvođača dela	OE broj	Primena / Opis	RAPIDEX broj
	Contitech 4186NP23	942 320 24 21	Actros MP II, Actros MP III (Voss 232)	VESA1920
	Fabio 344186-3S			

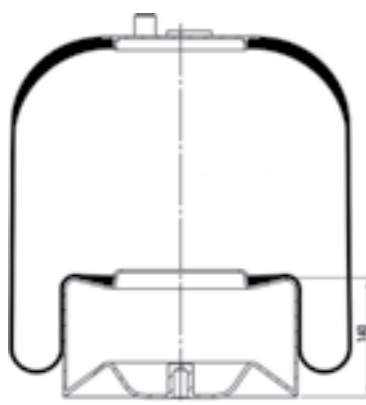
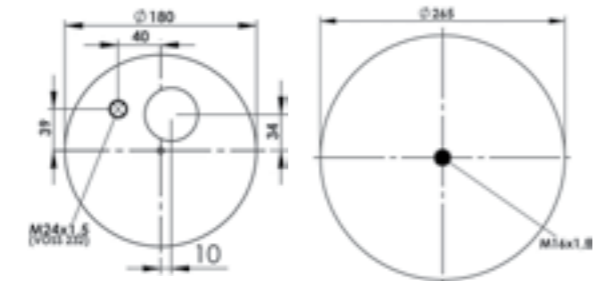
4186NP23 KPL				
	Broj proizvođača dela	OE broj	Primena / Opis	RAPIDEX broj
		Contitech 4186NP23 KPL Fabio 344186-3C	942 320 24 21	Actros MP II, Actros MP III (Voss 232)
				

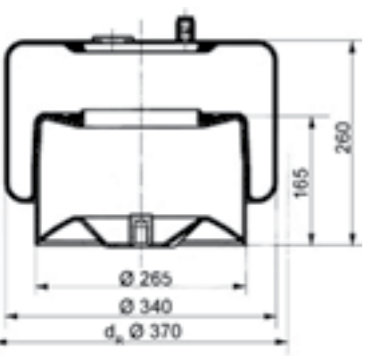
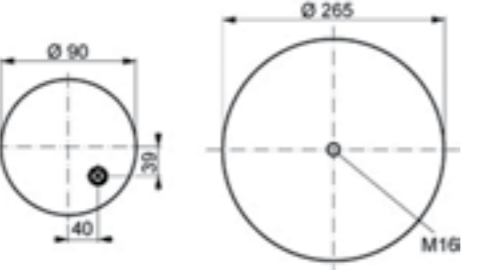
4187NP21				
	Broj proizvođača dela	OE broj	Primena / Opis	RAPIDEX broj
		Contitech 4187NP21 Fabio 344187-1C	942 320 26 21	Actros MP II (jedan priključak za vazduh Voss 232)
				

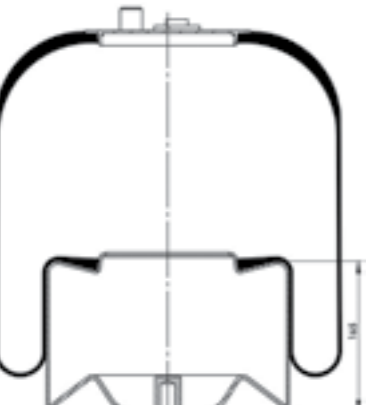
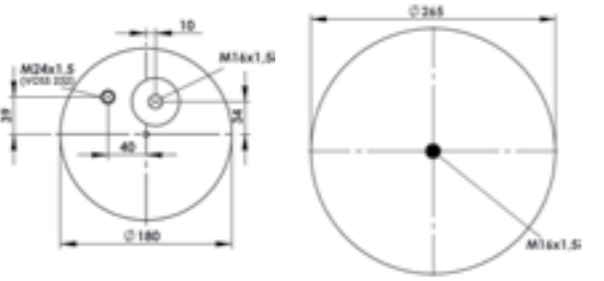
4187NP22				
	Broj proizvođača dela	OE broj	Primena / Opis	RAPIDEX broj
		Contitech 4187NP22 Fabio 344187-2C	942 320 27 21	Actros MP II (jedan priključak za vazduh)
				

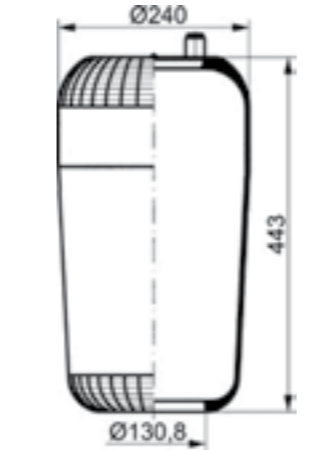
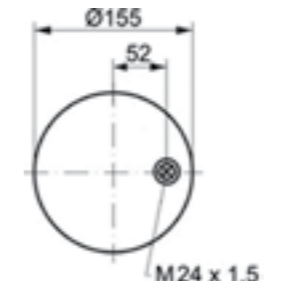
4390N1				
	Broj proizvođača dela	OE broj	Primena / Opis	RAPIDEX broj
		Contitech 4390N1 Fabio 344390-1S	942 328 00 01	Actros (jedan priključak za vazduh)
				

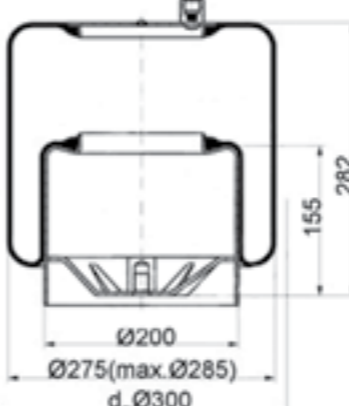
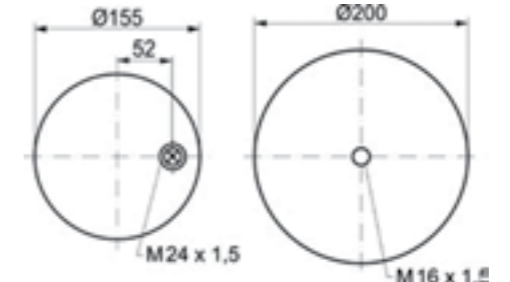
4390NP01				
	Broj proizvođača dela	OE broj	Primena / Opis	RAPIDEX broj
		Contitech 4390NP01 Fabio 344390-1C	942 320 01 21	Actros, zadnja osovina
				

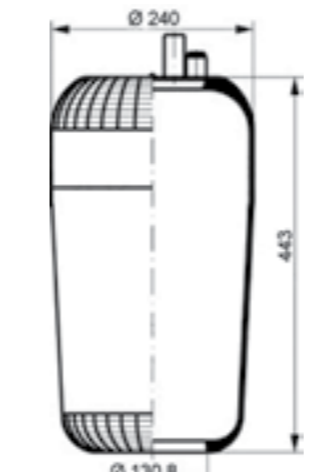
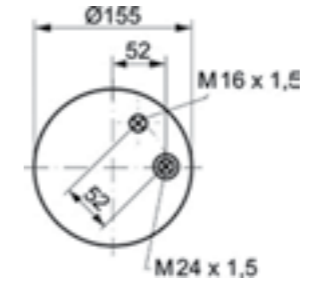
4390N2				
	Broj proizvođača dela	OE broj	Primena / Opis	RAPIDEX broj
		Contitech 4390N2 Fabio 344390-2S	942 328 01 01	Actros (dva priključka za vazduh)
				

4390NP02				
	Broj proizvođača dela	OE broj	Primena / Opis	RAPIDEX broj
		Contitech 4390NP02 Fabio 344390-2C	942 320 02 21	Atego, Actros

4391NP22				
	Broj proizvođača dela	OE broj	Primena / Opis	RAPIDEX broj
		Contitech 4391NP22 Fabio 344391-2C	942 320 06 21	Actros (dva priključka za vazduh Voss 230)

4644NP02				
	Broj proizvođača dela	OE broj	Primena / Opis	RAPIDEX broj
		Contitech 4644NP02 Fabio 344644-C	629 320 00 25	EVO-bus

4757N1				
	Broj proizvođača dela	OE broj	Primena / Opis	RAPIDEX broj
		Contitech 4757N1 Fabio 344757-1S	942 327 00 01	Atego, Actros

4757N2				
	Broj proizvođača dela	OE broj	Primena / Opis	RAPIDEX broj
		Contitech 4757N2 Fabio 344757-2S	974 328 00 01	Atego, Actros

4757NP01				
	Broj proizvođača dela	OE broj	Primena / Opis	RAPIDEX broj
		Contitech 4757NP01 Fabio 344757-1C	942 320 01 17	Atego, Actros, Eonic Prednja osovina

4757NP09				
	Broj proizvođača dela	OE broj	Primena / Opis	RAPIDEX broj
		Contitech 4757NP09 Fabio 344757-9C	974 320 04 17	Atego, prednja i zadnja osovina

4759NP01				
	Broj proizvođača dela	OE broj	Primena / Opis	RAPIDEX broj
		Contitech 4759NP01 Fabio 344759-C	942 320 02 17	Actros

4838NP01				
	Broj proizvođača dela	OE broj	Primena / Opis	RAPIDEX broj
		Contitech 4838NP01 Fabio 344838-1C	946 320 04 21	Actros

SZ 51-5				
	Broj proizvođača dela	OE broj	Primena / Opis	RAPIDEX broj
		Contitech SZ 51-5	-	Vazdušni jastuk sedišta C.O.B.O.

SA 51-10				
	Broj proizvođača dela	OE broj	Primena / Opis	RAPIDEX broj
		Contitech SA 51-10	-	Vazdušni jastuk sedišta Möve



SPRINTER BM 903 (zadna osovina)							
Poz.	Model	Opterećenje (t)	Širina (mm)	Broj listova x debljina lista (mm)	Dužina Lx/Ly (mm)	OE broj	RAPIDEX broj
1.	308, 310, 312, 314, 308CDI, 311CDI-316CDI 02/95-04/00	3,5	70	1 x 25	740/753	903 320 04 06	VESA0346
2.	314, 308CDI, 311CDI, 313CDI, 316CDI 04/00-05/06	-	70	1 x 19 1 x 20	740/753	903 320 19 06	VESA0347

SPRINTER BM 904 (zadna osovina)							
Poz.	Model	Opterećenje (t)	Širina (mm)	Broj listova x debljina lista (mm)	Dužina Lx/Ly (mm)	OE broj	RAPIDEX broj
3.	408CDI, 411CDI, 413CDI, 414CDI, 416CDI	-	70	1 x 12 1 x 15 1 x 28	740/750	904 320 16 06	VESA2031



SPRINTER BM 906 (zadna osovina)							
Poz.	Model	Opterećenje (t)	Širina (mm)	Broj listova x debljina lista (mm)	Dužina Lx/Ly (mm)	OE broj	RAPIDEX broj
4.	309CDI, 311CDI, 315CDI, 318CDI	2,2	70	1 x 25	740/753	906 320 18 06	VESA2040
5.	509CDI, 511CDI, 515CDI, 518CDI	3,5	70	1 x 15 1 x 17 1 x 28	740/753	906 320 02 06	VESA1515

ATEGO (prednja osovina)							
Poz.	Model	Opterećenje (t)	Širina (mm)	Broj listova x debljina lista (mm)	Dužina Lx/Ly (mm)	OE broj	RAPIDEX broj
6.	714, 717, 812, 814, 815, 817, 822	3,2	80	1 x 29	860/940	970 320 14 02	VESA0348
7.	714, 717, 812, 814, 815, 817, 823	3,4	80	1 x 30	860/940	970 320 07 02	VESA0349

ATEGO (prednja osovina)							
Poz.	Model	Opterećenje (t)	Širina (mm)	Broj listova x debljina lista (mm)	Dužina Lx/Ly (mm)	OE broj	RAPIDEX broj
8.	916-924, 1016-1024,1217-1229	4,4	80	1 x 24 1 x 26	860/940	974 320 20 02	VESA1367

ACTROS, ATEGO, AXOR (zadnja osovina)							
Poz.	Model	Opterećenje (t)	Širina (mm)	Broj listova x debljina lista (mm)	Dužina Lx/Ly (mm)	OE broj	RAPIDEX broj
9.	714, 717, 812, 814, 815, 817, 822 1517-1529	4,6	80	1 x 25 1 x 34	800/800	970 320 03 06	VESA0350
10.	714, 717, 812, 814, 815, 817, 823 1225, 1226	5,0	80	1 x 25 1 x 36	800/800	970 320 05 06	VESA0351



ACTROS, ATEGO, AXOR (prednja osovina)							
Poz.	Model	Opterećenje (t)	Širina (mm)	Broj listova x debljina lista (mm)	Dužina Lx/Ly (mm)	OE broj	RAPIDEX broj
11.	712-822, 1517-1529, 223-2229	6,3	80	1 x 23 2 x 24	860/940	974 320 46 02	VESA2041
12.	1823-1853, 2528-2536, 2628-2657 04/96-10/02	7,1	90	1 x 22 2 x 23	900/900	943 320 02 02	VESA0352
13.	1831-1857, 2531-2553, 2631-2657 04/96-10/02	7,1	90	2 x 27	900/900	943 320 09 02	VESA0353
14.	1823-1853, 2031-2051, 2528-2536, 2628-2633 04/96-10/02	7,5	90	1 x 22 2 x 24	900/900	943 320 04 02	VESA0354
15.	1831-1855, 2531-2555, 2631-2655	7,1	90	2 x 27	900/900	000 320 01 02	VESA0274

ACTROS, ATEGO, AXOR (prednja osovina)

Poz.	Model	Opterećenje (t)	Širina (mm)	Broj listova x debljina lista (mm)	Dužina Lx/Ly (mm)	OE broj	RAPIDEX broj
16.	1831-1855, 2531-2555, 2631-2655	7,5	90	2 x 28	900/900	000 320 02 02	VESA0169
17.	1831-2031, 2635-2643, 3231-3343 04/96-10/02	8,0	90	1 x 22 2 x 25	900/900	943 320 03 02	VESA0277
18.	1828-1833, 2532-2555, 2628-2651, 3331-4144 04/96-10/02	8,0	90	1 x 24 2 x 25	900/900	943 320 05 02	VESA0355
19.	1831-1853, 2531-2648, 3240-3243, 4140-4148 09/96-10/02	7,5	90	1 x 23 2 x 25	780/800	949 320 03 02	VESA0356
20.	1831-1853, 2531-2648, 3240-3243, 4140-4148 09/96-10/02	9,0	90	1 x 25 2 x 26	900/900	944 320 02 02	VESA1201

ACTROS, ATEGO, AXOR (zadnja osovina)

Poz.	Model	Opterećenje (t)	Širina (mm)	Broj listova x debljina lista (mm)	Dužina Lx/Ly (mm)	OE broj	RAPIDEX broj
21.	1831-1853, 2031-2640, 3240-3331 04/96-10/02	11,5	100	1 x 28 1 x 30 1 x 35	900/885	943 320 01 08	VESA0357
22.	1831-1853, 2031-2040	13,0	100	1 x 23 2 x 28 1 x 46	900/885	943 320 03 08	VESA1395



ACTROS, ATEGO, AXOR (zadnja osovina)							
Poz.	Model	Opterećenje (t)	Širina (mm)	Broj listova x debljina lista (mm)	Dužina Lx/Ly (mm)	OE broj	RAPIDEX broj
23.	1831-2031, 2531-2631, 3240-4140 04/96-10/02	9,5	100	2 x 37 1 x 49	780/780	948 320 15 05	VESA0275
24.	2631-2658, 3231-3248 04/96-10/02	9,5	100	2 x 37 1 x 48	780/780	948 320 17 05	VESA0276
25.	1831-2031, 2531-2631, 3235-3340, 4140 04/96-10/02	15,0	100	4 x 37	780/780	948 320 10 05	VESA0358
26.	3331-3360, 4140-4151 04/96-10/02	16,0	100	5 x 37	780/780	948 320 11 05	VESA0359

ACTROS, ATEGO, AXOR (zadnja osovina)							
Poz.	Model	Opterećenje (t)	Širina (mm)	Broj listova x debljina lista (mm)	Dužina Lx/Ly (mm)	OE broj	RAPIDEX broj
27.	1831-1855 04/96-10/02	13	100	1 x 23 4 x 25	900/750	944 320 02 08	VESA0273

ČAURE						
Slika	Poz.	Model	Dimenzije d / D / h (mm)	SE-M broj	OE broj	RAPIDEX broj
	1.	809K, 811K, 817, 914, 917, 1114, 1117 03/94-12/98	16 / 46 / 96	7589	673 320 00 50	VESA0470
	2.	Sprinter 308, 310, 312, 314, 308CDI, 311CDI-316CDI 02/95-04/00	12 / 49 / 80	7821	901 324 03 50	VESA1032
	3.	Atego 714, 717, 812, 814, 815, 817, 822	16 / 50 / 96	7896	970 320 00 44	VESA1033
	4.	Atego 714, 717, 812, 814, 815, 817, 822, 1517-1529	18 / 50 / 96	7897	970 320 01 44	VESA1034
	5.	Actros 1823-1853, 2528-2536, 2628-2657 04/96-10/02	24 / 62 / 96	1006	000 322 32 85	VESA1421
	6.	Actros 1831-1855 04/96-10/02, Atego 1823-2628	24 / 62 / 106	1007	000 325 07 85	VESA1036
	7.	1831-2031, 2531-2631, 3235-3340, 4140 04/96-10/02	A-232, B-165, h-152	8030	000 325 07 96	VESA0461

DELOVI STABILIZATORA							
Slika	Pozicija	Model	Mesto ugradnje	Dimenzije d x D x h (mm)	SE-M broj	OE broj	RAPIDEX broj
	1.	SPRINTER 208, 308, 310, 312, 316, 408, 412	PO	24 x 31	8075	904 323 00 85	VESA1340
	2.	LK 01/84-12/98, VARIO 512-815 09/96→, ATEGO 01/98-10/04, ATEGO 2 10/04→	ZO	17 x 38 x 38	8241	318 320 00 73	VESA0506
	3.	ACTROS 04/96-10/02, AXOR 2 10/04→, ATEGO 05/98-09/04, ACTROS MP II	ZO	58 x 82 x 56	7931	000 326 44 81	VESA0191
	4.	ACTROS 04/96-10/02, AXOR 2 10/04→, ATEGO 05/98-09/04, ACTROS MP II, AXOR 01/02-10/04, MK, SK 09/89-09/96	PO	38.5 x 61 x 56	7729	000 326 24 81	VESA0467
	5.	ACTROS 04/96-10/02, AXOR 2 10/04→, ATEGO 05/98-09/04	PO/ ZO	40 x 65 x 45	8040	941 326 03 50	VESA0735
	6.	ACTROS 04/96-10/02, AXOR 2 10/04→, ATEGO 05/98-09/04, ACTROS MP II, AXOR 01/02-10/04, ECONIC 01/98→	ZO	40 x 70 x 36.5/46	7862	000 323 79 85	VESA0103
	7.	ACTROS 04/96-10/02, AXOR 2 10/04→, ATEGO 05/98-09/04, ACTROS MP II, AXOR 01/02-10/04, ECONIC 01/98→	ZO	40 x 80 x 46	7965	000 323 81 85	VESA0245

DELOVI STABILIZATORA							
Slika	Pozicija	Model	Mesto ugradnje	Dimenzije d x D x h (mm)	SE-M broj	OE broj	RAPIDEX broj
	8.	ACTROS 04/96-10/02, AXOR 2 10/04→, ATEGO 05/98-09/04, ACTROS MP II, AXOR 01/02-10/04, ECONIC 01/98→	ZO	82 x 110 x 65	7861	941 326 00 50	VESA0464
	9.	ATEGO, ATEGO II	PO	12 x 30 x 30	8237	309 320 00 73	VESA0456
	10.	ATEGO, ATEGO II	PO	25 x 47 x 62	8784	970 323 12 85	VESA1499
	11.	ATEGO, ATEGO II	PO/ ZO	33 x 47 x 62	8772	970 323 15 85	VESA0257
	12.	ACTROS, ACTROS MP II, AXOR, AXOR II	PO	70 x 98 x 67	7963	941 323 01 50	VESA1941
	13.	EGO, ACTROS, AXOR, AXOR II	ZO	20,5 x 88 x 130	7860	942 326 00 50	VESA0465
	14.	ACTROS, ACTROS MP II, AXOR,	ZO	19 x 73 x 100	7964	941 323 00 50	VESA1942





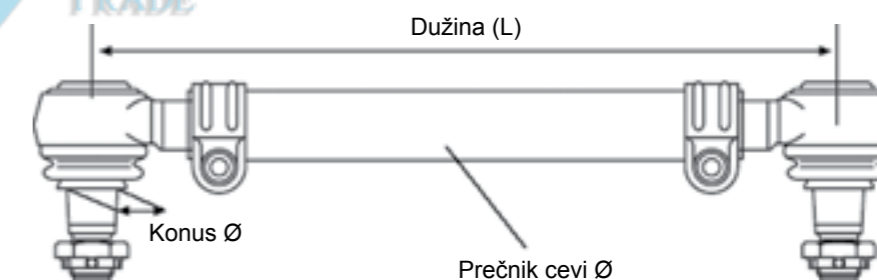

SET STABILIZATORA				
Slika	Poz.	Model / Opis	SE-M / OE broj	RAPIDEX broj
	1.	ACTROS 04/96-10/02, AXOR 2 10/04→, ATEGO 05/98-09/04, ACTROS MP II, AXOR 01/02-10/04, ECONIC 01/98→ Prednja i zadnja osovina	8000 000 3237985S-1	VESA0631
	2.	ACTROS 04/96-10/02, AXOR 2 10/04→, ATEGO 05/98-09/04, ACTROS MP II, AXOR 01/02-10/04, ECONIC 01/98→ Prednja i zadnja osovina	7999 000 3237985S-2	VESA0632
	3.	ACTROS 04/96-10/02, AXOR 2 10/04→, ATEGO 05/98-09/04, ACTROS MP II, AXOR 01/02-10/04, ECONIC 01/98→ Prednja i zadnja osovina	7998 000 3237985S-3	VESA0462







DELOVI RUKAVACA				
Slika	Poz.	Model	OE broj	RAPIDEX broj
	1.	ACTROS, ACTROS MP II, AXOR 2, ATEGO	942 330 05 19	OSOV0266
	2.	NG, SK, MK, AXOR, ACTROS, ACTROS MP II, ATEGO	625 330 01 19	VESA0432
	3.	NG, SK, MK, ACTROS, ACTROS MP II, ATEGO, AXOR	346 330 00 19	VESA0583
	4.	NG, SK	625 330 02 19	VESA0013
	5.	ACTROS, ACTROS MP II, ATEGO, NG, MK	346 330 01 19	VESA0616

DELOVI RUKAVACA				
Slika	Poz.	Model	OE broj	RAPIDEX broj
	6.	LK, LN	670 330 02 19	VESA0484
	7.	ACTROS, ATEGO, AXOR, MK, SK	326 330 02 19	VESA0754
	8.	ACTROS, ATEGO, AXOR 2, CITARO	655 330 04 19	VESA0751
	9.	MK, NG, SK	391 330 00 19	VESA0688
	10.	NK, SK, 0303, 0405, 0407, 0408	300 330 00 19	VESA0425



SPONE				
Poz.	Model	Opis	OE broj	RAPIDEX broj
1.	ATEGO 1998-2004, ATEGO 2 2004→	Dužina: 846 (mm) Ø Cevi: 42 (mm) Ø Konusa: 26 (mm)	970 460 07 05 970 460 09 05	VESA2010
2.	ATEGO 1998-2004, ATEGO 2 2004→	Dužina: 837 (mm) Ø Cevi: 40 (mm) Ø Konusa: 26 (mm)	972 460 14 05 972 460 16 05	VESA2011
3.	ATEGO 1998-2004, ATEGO 2 2004→	Dužina: 894 (mm) Ø Cevi: 50 (mm) Ø Konusa: 30/26 (mm)	972 460 20 05 972 460 18 05	VESA0296
4.	ATEGO 1998-2004, ATEGO 2 2004→	Dužina: 894 (mm) Ø Cevi: 50 (mm) Ø Konusa: 30 (mm)	974 460 12 05 974 460 10 05	VESA2038

SPONE				
Poz.	Model	Opis	OE broj	RAPIDEX broj
5.	ATEGO, AXOR 2, ACTROS 1997-2002, ACTROS MP II 2003→	Dužina: 879 (mm) Ø Cevi: 36 (mm) Ø Konusa: 28,6 (mm)	002 460 44 05 002 460 43 05	VESA0757
				
6.	MK, NG, SK, ATEGO, AXOR, AXOR 2, ACTROS 1997-2002, ACTROS MP II 2003→	Dužina: 876 (mm) Ø Cevi: 40 (mm) Ø Konusa: 28,6 (mm)	002 460 48 05 002 460 47 05	VESA2009
				
7.	ATEGO 1998-2004, AXOR 2002-2004, AXOR 2 2004→	Dužina: 895 (mm) Ø Cevi: 40 (mm) Ø Konusa: 28,6 (mm)	002 460 49 05 002 460 50 05	VESA0038
				
8.	ATEGO, AXOR, AXOR 2, ACTROS 1997-2002, ACTROS MP II 2003→	Dužina: 895 (mm) Ø Cevi: 36 (mm) Ø Konusa: 28,6 (mm)	002 460 46 05 002 460 45 05	VESA2012
				
9.	ACTROS 1996-2002, ACTROS MP II 2003→	Dužina: 858 (mm) Ø Cevi: 40 (mm) Ø Konusa: 28,6 (mm)	002 460 97 05 002 460 96 05	VESA2008
				
10.	ATEGO 1998-2004, ATEGO 2 2004→	Dužina: 1640 (mm) Ø Cevi: 40 (mm) Ø Konusa: 26 (mm)	970 330 02 03 970 330 00 03 970 330 01 03 970 330 04 03	VESA2013
				

SPONE				
Poz.	Model	Opis	OE broj	RAPIDEX broj
11.	ATEGO 1998-2004, ATEGO 2 2004→	Dužina: 1605 (mm) Ø Cevi: 40 (mm) Ø Konusa: 30 (mm)	975 330 02 03 975 330 03 03 975 330 08 03 975 330 17 03	VESA2014
				
12.	ATEGO, AXOR, AXOR 2, ACTROS 1996-2002, ACTROS MP II, 2003→	Dužina: 1735 (mm) Ø Cevi: 52 (mm) Ø Konusa: 32 (mm)	942 330 00 03, 942 330 01 03, 942 330 02 03, 942 330 07 03, 942 330 11 03	VESA2015
				
13.	ATEGO, AXOR 2, ACTROS 1996-2002, ACTROS MP II, 2003→	Dužina: 1735 (mm) Ø Cevi: 62 (mm) Ø Konusa: 32 (mm)	945 330 00 03 945 330 01 03 945 330 04 03 945 330 06 03	VESA0190
				
14.	ATEGO, AXOR, ACTROS 1996-2002	Dužina: 1565 (mm) Ø Cevi: 50 (mm) Ø Konusa: 32 (mm)	942 330 09 03 942 330 05 03 942 330 06 03	VESA0744
				
15.	ATEGO, AXOR, ACTROS 1996-2002, ACTROS MP II, 2003→	Dužina: 1735 (mm) Ø Cevi: 50 (mm) Ø Konusa: 32 (mm)	941 330 02 03 941 330 00 03 941 330 01 03 941 330 03 03	VESA0127
				
16.	ATEGO, AXOR, ACTROS 1996-2002, ACTROS MP II 2003→	Dužina: 1664 (mm) Ø Cevi: 50 (mm) Ø Konusa: 32 (mm)	942 330 03 03 942 330 04 03 942 330 16 03	VESA0037
				

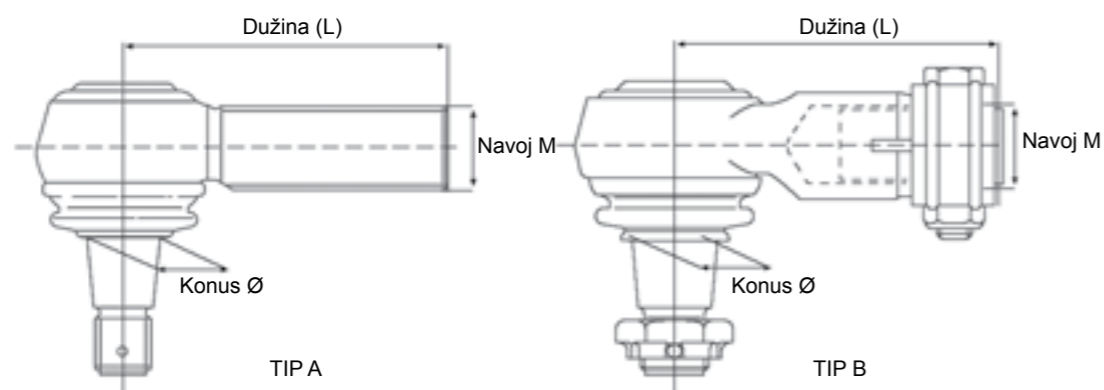

DELOVI SPONA							
Poz.	Model	Dužina L (mm)	Konus Ø (mm)	Navoj M (mm)	Tip A/B	OE broj	RAPIDEX broj
1.	SPRINTER 901, 902, 903, 904	76	18	M16 x 1.5 ∩	B	901 460 01 48	VESA0114
2.	LK, LP, NG	95	20	M24 x 1.5 ∩	A	000 330 85 35	VESA0182
3.	LK, LP, NG	95	20	M24 x 1.5 ∩	A	000 330 86 35	VESA0183
4.	ATEGO, ATEGO 2, AXOR, ACTROS, ACTROS MP II/MP III	95	30	M26 x 1.5 ∩	B	000 460 49 48	VESA0845
5.	LP	105	22	M24 x 1.5 ∩	A	000 330 12 35	VESA0098
6.	LP	105	22	M24 x 1.5 ∩	A	000 330 13 35	VESA0099
7.	LK, NG	105	22	M28 x 1.5 ∩	A	000 330 14 35	VESA0096

DELOVI SPONA							
Poz.	Model	Dužina L (mm)	Konus Ø (mm)	Navoj M (mm)	Tip A/B	OE broj	RAPIDEX broj
8.	LK, NG	105	22	M28 x 1.5 ∩	A	000 330 15 35	VESA0097
9.	LK	115	22	M30 x 1.5 ∩	A	000 330 31 35	VESA0100
10.	LK, MK, NG	115	26	M30 x 1.5 ∩	A	000 330 01 48	VESA0018
11.	LK, MK, NG	115	26	M30 x 1.5 ∩	A	000 330 02 48	VESA0846
12.	O403, O404, TOURISIMO	120	30	M24 x 1.5 ∩	A	001 460 21 48	VESA0050
13.	O403, O404, TOURISIMO	120	30	M24 x 1.5 ∩	A	001 460 20 48	VESA0051
14.	LK, NG	120	26	M30 x 1.5 ∩	A	000 460 01 48	VESA0847
15.	MK, NG, SK, ATEGO, ATEGO 2, AXOR, AXOR 2, ACTROS, ACTROS MP II/MP III	120	30	M30 x 1.5 ∩	A	000 340 11 70	VESA2023
16.	MK, NG, SK, ATEGO, ATEGO 2, AXOR, AXOR 2, ACTROS, ACTROS MP II/MP III	120	30	M30 x 1.5 ∩	A	000 340 61 69	VESA2022
17.	ACTROS, ACTROS MP II/MP III	120	32	M30 x 1.5 ∩	A	000 460 58 48	VESA0742
18.	ACTROS, ACTROS MP II/MP III	120	32	M30 x 1.5 ∩	A	000 460 57 48	VESA0848
19.	O303, O305, O307, O405, O407	150	26	M35 x 1.5 ∩	B	000 330 40 35	VESA0853
20.	O303, O305, O307, O405, O407	150	26	M35 x 1.5 ∩	B	000 330 19 35	VESA0854

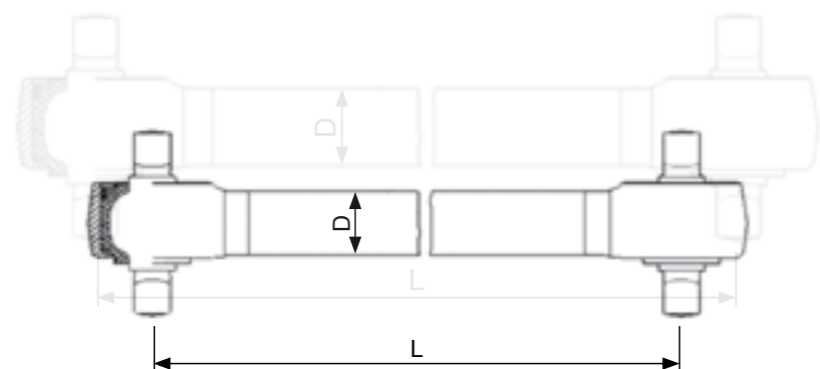

UPORNE SPONE							
Poz.	Model	L (mm)	D (mm)	Reparatur set	Lemförder broj	OE broj	RAPIDEX broj
1.	ACTROS MP II 2536-2555LS 04/03→	850	62	000 330 14 11	22055 01	945 330 00 07	VESA0629
2.	ACTROS MP II 2551LS 04/03→	845	60	000 330 14 11	22092 01	941 330 00 07	VESA0983
3.	ACTROS 2535-4148 04/97-10/02→, ACTROS MP II 3331-4151 04/03→	565	50	000 350 27 05	29461 01	948 350 06 05	VESA0984
4.	O340 Tourismo	585	56	-	11413 01	317 350 06 06	VESA0562

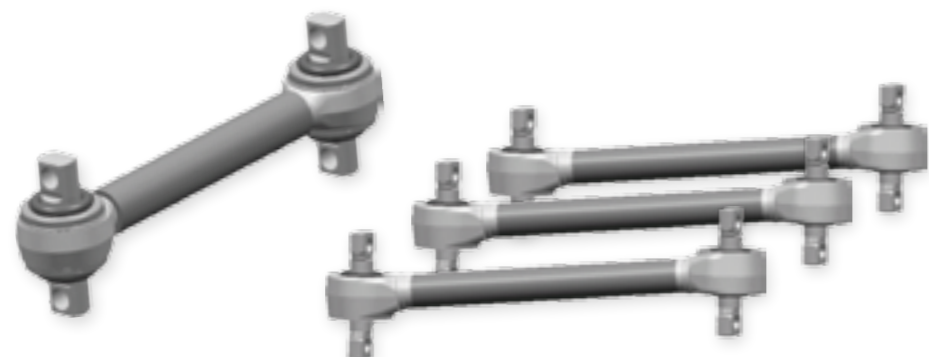

V SPONE							
Poz.	Model	L (mm)	D (mm)	Reparatur set	Lemförder broj	OE broj	RAPIDEX broj
1.	NG, Econic, ACTROS 2031, 2540, ACTROS MP II, Atego 2528, Axor 2 2528 prateća osovina	622	46	000 350 4605 (1x) 000 350 4705 (2x)	23065 01	942 350 11 05	VESA0449
2.	Econic, ACTROS 1831- 3343, ACTROS MP II, Axor 2 1823-3240, Atego 1823-2628,	622	48	000 350 2305 (1x) 000 350 2205 (2x)	21168 01	942 350 10 05	VESA0429
3.	ACTROS 2535-4148 04/97-10/02, ACTROS MP II 04/03→, Atego 2628, Axor 2 2628-3243 10/04→	622	46	000 350 3505 (1x) 000 350 3405 (2x)	23069 02	948 350 30 05	VESA0626
4.	ACTROS 1831-1857 04/96-10/02, ACTROS MP II 04/03→, Atego 1823-28, Axor 2535 01/02-10/04, Axor 2 10/04→	622	46	000 350 5105 (1x) 000 350 4805 (2x)	31887 01	942 350 12 05	VESA0627
5.	ACTROS 3331-4140 04/97→10/02, ACTROS MP II 04/03→	622	60	000 350 3605 (1x) 000 350 3705 (2x)	26031 01	948 350 22 05	VESA0250
6.	ACTROS 3331-3357 04/97-10/02, ACTROS 4140-4148, ACTROS MP II	667	60	000 350 3605 (1x) 000 350 3705 (2x)	25314 01	948 350 23 05	VESA0253

6.0 KABINA I DELOVI KABINE



6.0 KABINA I DELOVI KABINE

6.1	Delovi kabine	188
6.2	Ogledala i delovi ogledala	229
6.3	Cilindri i pumpe za dizanje kabine	234
6.4	Elementi za oslanjanje kabine	237
6.5	Uređaji za pranje vetrobranskog stakla	239
6.6	Mehanizam vrata	240



KARO0469



KARO0468



KARO0453

KARO0452

KARO0454



KARO0455

KARO0456



KARO0478



KARO0479



KARO0480



KARO0481





KARO0469



KARO0468

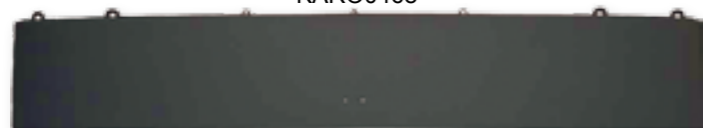

KARO0458



KARO0457



KARO0482



KARO0483



KARO0484



KARO0485



KARO0459



KARO0460



KARO0461



KARO0462

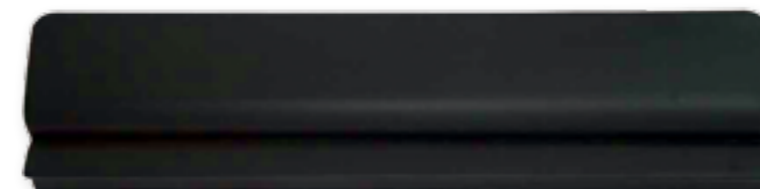

KARO0463

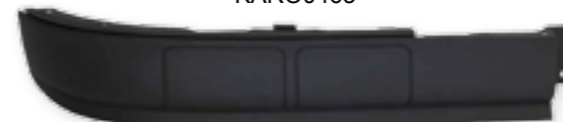

KARO0464

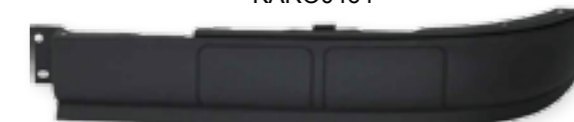



KARO0465



KARO0466



KARO0467



KARO0470



KARO0471



KARO0474



KARO0475



KARO0476



KARO0477



KARO0486



KARO0472



KARO0473



KARO0487



KARO0507



KARO0508



KARO0509



KARO0510





KARO0487



KARO0436

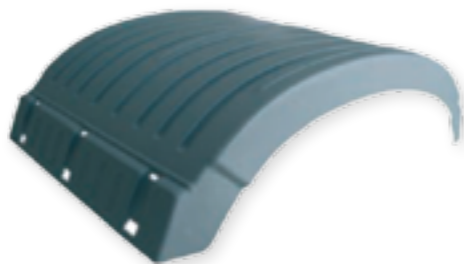

KARO0926



KARO0925



KARO0432



KARO0449



KARO1263



KARO0506



KARO1028



KARO978





KARO1263



KARO0506



KARO0517



KARO0518



KARO0521



KARO0522



KARO0519



KARO0520



KARO0491



KARO0495



KARO0492



KARO0493



KARO0494



KARO1402



KARO1403



KARO1404



KARO1405



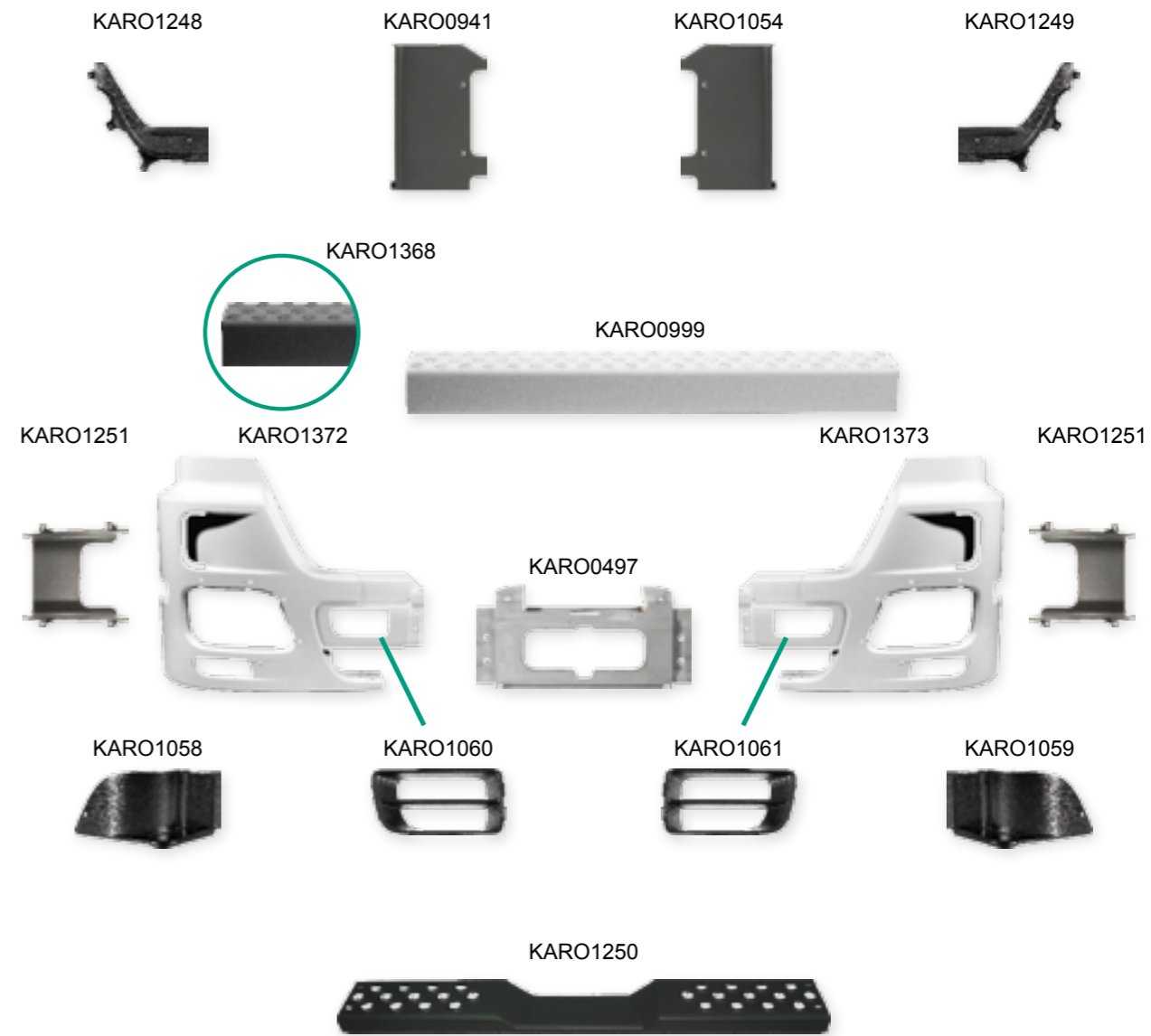



KARO1464



KARO0505



KARO1253



KARO0489



KARO1044



KARO1369



KARO0490



KARO1167



KARO1101



KARO0997



KARO1020



KARO1041



KARO0482



KARO0483



KARO1042



KARO1256



KARO1370



KARO0484



KARO0485



KARO0209

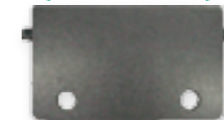

KARO1254



KARO1257



KARO1258



KARO1255





KARO1374



KARO1055



KARO1260



KARO1372



KARO0498



KARO1407



KARO1406



KARO1262



KARO1056



KARO1375



KARO1373



KARO1259



KARO1409



KARO0499



KARO1261



KARO1408





KARO1227

SPOLJAŠNJI



KARO1228

SPOLJAŠNJI



KARO1230

UNUTRAŠNJI



KARO1229

UNUTRAŠNJI



KARO0486



KARO0448



KARO1197



KARO1008



KARO1007





KARO1245



KARO1410



KARO1247



KARO0935



KARO1366



KARO1367



KARO1227



KARO1228



KARO1230



KARO1229



KARO1207



KARO1208



KARO1364



KARO1365





KARO1200



KARO1201



KARO1206



KARO1202



KARO1203



KARO1198



KARO1199



KARO1234



KARO1233



KARO1231



KARO1232



KARO1204



KARO1235



KARO1205



KARO1093



KARO1242



KARO1241



KARO1238



KARO1237



KARO1095



KARO1236



KARO1239



KARO1235



KARO1240





KARO1245



KARO1246



KARO1243



KARO1244



KARO1194



KARO1195



KARO0486



KARO0448



KARO1197



KARO1008



KARO1007





KARO0549



KARO0550



KARO0551



KARO0552



KARO0553



KARO0554



KARO0555



KARO0556



KARO0561

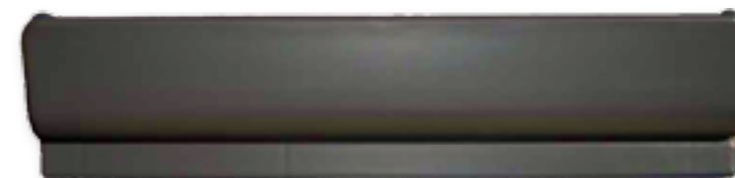

KARO0557



KARO0558



KARO0562



KARO0563

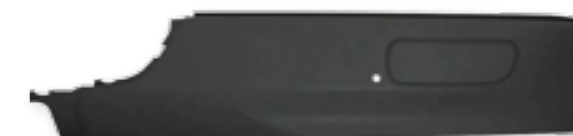

KARO0560



KARO0559





KARO0534



KARO0535



KARO0536



KARO0538



KARO0537

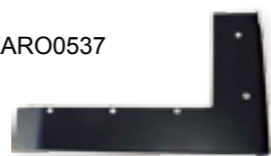

KARO0539



KARO0540

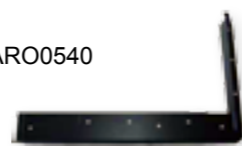

KARO0542



KARO0541



KARO0543



KARO0545



KARO0544



KARO0546



KARO0548



KARO0547





KARO0525



KARO0526



KARO0527



KARO0528



KARO0529

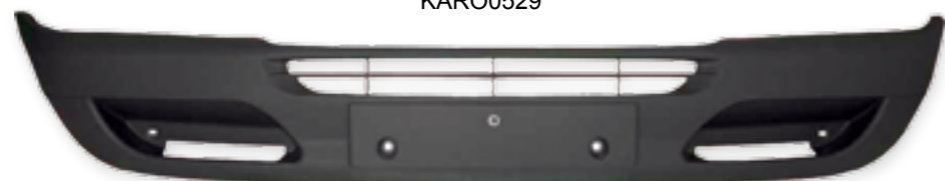

KARO0530



KARO0531



KARO0532



KARO0533





KABI1337

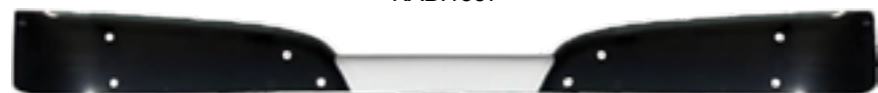

KABI1338

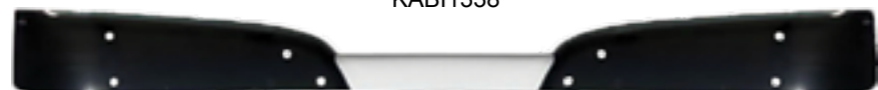

ACTROS MP III

Poz.	Naziv	OE broj	RAPIDEX broj
1.	SUNCOBRAN	943 810 04 10	KABI1337
2.	SUNCOBRAN	943 811 08 10	KABI1338



KABI1339



KABI1340

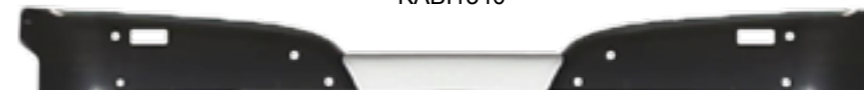

ACTROS MP III

Poz.	Naziv	OE broj	RAPIDEX broj
1.	SUNCOBRAN	943 810 06 10	KABI1339
2.	SUNCOBRAN	943 811 10 10	KABI1340





KABI1318



KABI1321

ACTROS MP II			
Poz.	Naziv	OE broj	RAPIDEX broj
1.	SUNCOBRAN	943 811 00 10	KABI1318
2.	SET ZA MONTAŽU	943 810 08 14	KABI1321



KABI1322



KABI1323

ACTROS MP II			
Poz.	Naziv	OE broj	RAPIDEX broj
1.	SUNCOBRAN	943 811 02 10	KABI1322
2.	SET ZA MONTAŽU	943 810 13 14	KABI1323



KABI1315



KABI1324



KABI1320

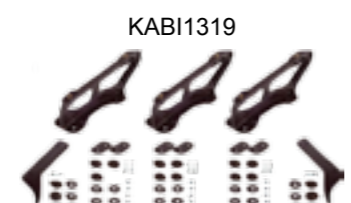

KABI1319

ACTROS MP I			
Poz.	Naziv	OE broj	RAPIDEX broj
1.	SUNCOBRAN	941 810 10 10	KABI1315
2.	SUNCOBRAN	941 810 00 10	KABI1320
3.	SET ZA MONTAŽU	941 810 07 14	KABI1324
4.	SET ZA MONTAŽU	941 810 11 14	KABI1319



KABI1317

ACTROS MP I			
Poz.	Naziv	OE broj	RAPIDEX broj
1.	SUNCOBRAN	941 811 08 10	KABI1317





KABI0765



KABI1342

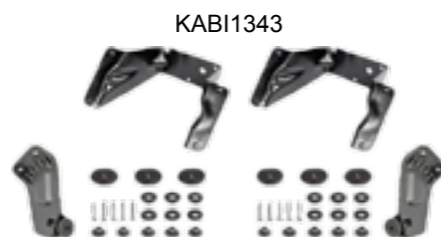

KABI1343

AXOR II			
Poz.	Naziv	OE broj	RAPIDEX broj
1.	SUNCOBRAN	973 811 05 10	KABI0765
2.	SUNCOBRAN	973 811 08 10	KABI1342
3.	SET ZA MONTAŽU	002 810 05 14	KABI1343



KABI1344



KABI1345

AXOR I			
Poz.	Naziv	OE broj	RAPIDEX broj
1.	SUNCOBRAN	973 811 03 10	KABI1344
2.	SET ZA MONTAŽU	973 810 00 14	KABI1345



KABI1316



KABI1325

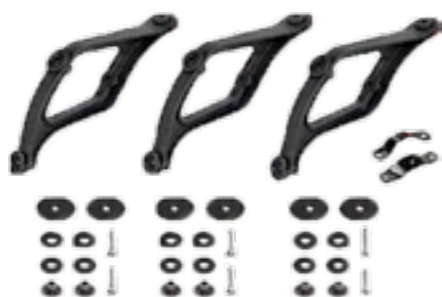

AXOR I			
Poz.	Naziv	OE broj	RAPIDEX broj
1.	SUNCOBRAN	973 811 04 10	KABI1316
2.	SET ZA MONTAŽU	973 810 15 14	KABI1325



KABI1347



KABI1348



KABI1349



ATEGO II, III			
Poz.	Naziv	OE broj	RAPIDEX broj
1.	SUNCOBRAN	973 811 07 10	KABI1347
2.	SUNCOBRAN	973 810 10 10	KABI1348
3.	SET ZA MONTAŽU	002 810 06 14	KABI1349



KABI1316



KABI1325



ATEGO I

Poz.	Naziv	OE broj	RAPIDEX broj
1.	SUNCOBRAN	973 811 04 10	KABI1316
2.	SET ZA MONTAŽU	973 810 15 14	KABI1325

1013 - 2644, O303, 404, 405, 407



OE broj	MEKRA broj	Opis	Položaj	Grejač	Dimenzije (mm)	RAPIDEX broj
381 810 25 16	51.2530.120H		◀ ▶		370 x 182 x 64	KABI0524
381 810 73 16	51.2530.140H		◀ ▶		370 x 182 x 64	KABI0525
000 811 33 33	40.2530.222H				356 x 170 x 3	KABI0526
	40.2530.422H				356 x 170 x 3	KABI0527

SK, NG (1991 - 1996)



OE broj	MEKRA broj	Opis	Položaj	Grejač	Dimenzije (mm)	RAPIDEX broj
641 810 42 16	51.3680.147H				440 x 182 x 132	KABI0528
	40.3680.422H				427 x 169 x 3	KABI0529

SK, NG (1991 - 1996)



OE broj	MEKRA broj	Opis	Položaj	Grejač	Dimenzije (mm)	RAPIDEX broj
641 810 46 16	56.3670.147H		◀ ▶		225 x 185 x 129	KABI0395
	40.3670.404H				209 x 169 x 3	KABI0530

ACTROS (1996 - ...), ECONIC (1998 - ...)



OE broj	MEKRA broj	Opis	Položaj	Grejač	Dimenzije (mm)	RAPIDEX broj
	61.3780.147H		◀ ▶		433 x 188 x 85	KABI0240
000 810 91 16	61.3783.167H		◀ ▶		433 x 188 x 85	KABI0416
001 811 20 33	15.3784.470H				433 x 188 x 15	KABI0417
000 810 95 16	61.3782.147H		◀ ▶		433 x 188 x 68	KABI0854
000 810 94 16	61.3782.167H		◀ ▶		433 x 188 x 68	KABI0293

ACTROS (1996 - ...), ATEGO (1998 - 2004), ECONIC (1998 - ...)



OE broj	MEKRA broj	Opis	Položaj	Grejač	Dimenzije (mm)	RAPIDEX broj
001 810 92 16	61.3770.147H		◀ ▶		200 x 200	KABI1243
001 811 21 33	15.3774.410H		◀ ▶		200 x 200 x 15	KABI0461
001 811 60 33	15.3771.174H		◀ ▶		200 x 200 x 15	KABI0862
000 810 96 16	61.3772.147H		◀ ▶		200 x 200 x 68	KABI0855

ACTROS (1996 - ...), ECONIC (1998)



OE broj	MEKRA broj	Opis	Položaj	Grejač	Dimenzije (mm)	RAPIDEX broj
941 810 10 16	59.3792.127H		◀ ▶		310 x 170 x 83	KABI0857
001 811 22 33	15.3794.410H				310 x 170 x 15	KABI0404

ATEGO (1998 - 2004), AXOR (2001 - 2004)



OE broj	MEKRA broj	Opis	Položaj	Grejač	Dimenzije (mm)	RAPIDEX broj
000 810 02 79	61.3752.147H		◀ ▶		380 x 170 x 68	KABI0388
001 811 34 33	15.3752.470H				380 x 170 x 15	KABI0415

ATEGO II, AXOR II (2004 - ...)



OE broj	MEKRA broj	Opis	Položaj	Grejač	Dimenzije (mm)	RAPIDEX broj
000 810 18 79	61.5751.167		◀		435 x 215 x 129	KABI0858
000 810 15 79	51.5750.002		▶		435 x 215 x 129	OPRE0075
001 811 99 33	15.5750.840H		◀ ▶		431 x 186 x 15	KABI0374
002 811 46 33	19.5750.011		◀ ▶		435 x 196 x 39	KABI1125
000 820 27 13	09.5750.001		◀ ▶		KABEL	OPRE0693

ATEGO II, AXOR II (2004)



OE broj	MEKRA broj	Opis	Položaj	Grejač	Dimenzije (mm)	RAPIDEX broj
002 810 08 16	56.1014.001H				300 x 163	KABI1244

ATEGO II, AXOR II (2004)



OE broj	MEKRA broj	Opis	Položaj	Grejač	Dimenzije (mm)	RAPIDEX broj
000 810 16 79	61.5770.147H		◀ ▶		215 x 199 x 129	KABI0859
002 811 00 33	15.5770.870H		◀ ▶		192 x 186 x 15	KABI0531

ACTROS (1996 - ...), ECONIC (1998 - ...)



RAPIDEX broj
KABI0373



RAPIDEX broj
KABI0419



RAPIDEX broj
KABI0292



RAPIDEX broj
KABI0308

NOSAČ OGLEDALA - ACTROS MP I

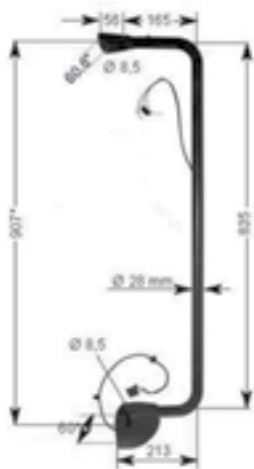

OE broj	MEKRA broj	Opis	Položaj	Grejač	Dimenzije (mm)	RAPIDEX broj
001 810 45 14	58.3781.200H		►		983 x 197 x Ø28	KABI0273
001 810 44 14	58.3781.100H		◄		983 x 197 x Ø28	KABI1044

NOSAČ OGLEDALA - ACTROS MP II

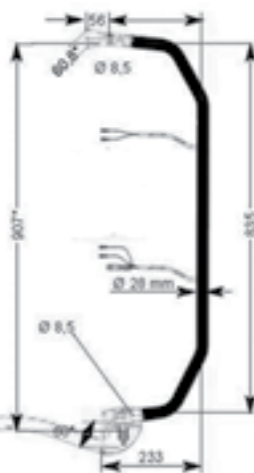

OE broj	MEKRA broj	Opis	Položaj	Grejač	Dimenzije (mm)	RAPIDEX broj
002 810 08 14	58.3783.300H		◄		983 x 227 x Ø28	KABI1045
002 810 09 14	58.3783.200H		►		983 x 227 x Ø28	KABI1046

ACTROS MP I, MP II - OGLEDALO ISPRED KABINE



OE broj	MEKRA broj	Opis	Položaj	Grejač	Dimenzije (mm)	RAPIDEX broj
943 810 47 16	59.3965.210H		►		1219 x 303	KABI1047
001 811 69 33	15.3961.174H		◄►		250 x 45	KABI1024

ACTROS MP III



OE broj	MEKRA broj	Opis	Položaj	Grejač	Dimenzije (mm)	RAPIDEX broj
	KOMPLET		►			KABI1368
	KOMPLET		◄			KABI1369
002 811 33 33	19.1012.002.099		◄		401 x 200	KABI1201
002 811 34 33	19.1012.003.099		►		401 x 200	KABI1202
002 811 37 33	19.1012.000.099		◄		191 x 193	KABI0461
002 811 38 33	19.1012.001.099		►		191 x 193	KABI1200
002 810 26 16			◄			KABI1413
002 810 27 16			►			KABI1418
002 810 32 14		NOSAČ	◄			KABI1420
002 810 33 14		NOSAČ	►			KABI1421
943 811 03 07		POKLOPAC	◄			KABI1442
943 811 04 07		POKLOPAC	►			KABI1443
002 810 24 16		NOSAČ POKLOPCA	◄			KABI1424
002 810 25 16		NOSAČ POKLOPCA	►			KABI1425
006 820 92 42		MOTOR	◄►			KABI1419

LEGENDA:



MANUELNO
PODEŠAVANJE



ELEKTRIČNO
PODEŠAVANJE



STAKLO



PLOKLOPAC
KUĆIŠTE



GREJAČ



UNIVERZALAN
POLOŽAJ

◄ LEVI POLOŽAJ

► DESNI POLOŽAJ

CILINDRI ZA DIZANJE KABINE			
Poz.	Model	OE broj	RAPIDEX broj
1.	SK	001 553 09 05	KABI0557
			
2.	SK	001 553 17 05	KABI0558
			
3.	SK	001 553 96 05	KABI0559
			
4.	SK	001 553 10 05	KABI0560
			
5.	ATEGO	973 553 00 05	KABI0265
			
6.	AXOR	002 553 44 05	KABI0561
			
7.	AXOR	002 553 82 05	KABI0263
			

CILINDRI ZA DIZANJE KABINE			
Poz.	Model	OE broj	RAPIDEX broj
8.	AXOR	002 553 85 05	KABI0264
			
9.	ACTROS	002 553 10 05	KABI0072
			
10.	ACTROS	002 553 91 05	KABI0334
			
11.	ACTROS	002 553 92 05	KABI0333
			
12.	ACTROS	002 553 54 05	KABI0331
			

PUMPE ZA DIZANJE KABINE				
Poz.	Slika	Model	OE broj	RAPIDEX broj
1.		SK, LK	000 553 79 01	HIDR0076
2.		SK, ACTROS	001 553 59 01	HIDR0077
3.		ACTROS	001 553 34 01	HIDR0125
4.		ACTROS	001 553 35 01	KABI0565
5.		ACTROS	001 553 36 01	HIDR0046
6.		ACTROS	001 553 37 01	HIDR0051
7.		ACTROS	001 553 38 01	KABI0566

ELEMENTI ZA OSLANJANJE KABINE			
Poz.	Slika	Model / OE broj	RAPIDEX broj
		NG, SK	
1.		387 310 00 77	KABI0452

ELEMENTI ZA OSLANJANJE KABINE					
Poz.	Slika	Model	Dimenzije (mm)	OE broj	RAPIDEX broj
1.		SK	M10 x 22	371 492 70 87	VESA0815
2.		SK, LK	20 x 8 x 100	385 268 14 74	KABI0588
3.		SK, LK	42 x 20	000 981 39 31	KABI0589
4.		ACTROS		942 500 00 50	KABI0440
5.		ACTROS		942 317 22 12	AMOR0223
6.		ACTROS MP II		942 317 18 12	KABI0338

ELEMENTI ZA OSLANJANJE KABINE					
Poz.	Slika	Model	Dimenzije (mm)	OE broj	RAPIDEX broj
7.		ACTROS MP II	65 x 16 x 64	942 317 23 12	KABI0337
8.		ACTROS, ACTROS MP II	69 x 16 x 64	000 992 16 03	KABI0080
9.		ATEGO II, AXOR, ACTROS		940 317 10 12	KABI0450
10.		ATEGO II, AXOR, ACTROS		940 317 11 12	KABI0449
11.		ATEGO II, AXOR, ACTROS		942 317 20 12	KABI0448
12.		ATEGO II, AXOR, ACTROS		942 317 21 12	KABI0447
13.		ACTROS		942 310 02 83	KABI0368
14.		ACTROS		942 310 03 83	KABI0367

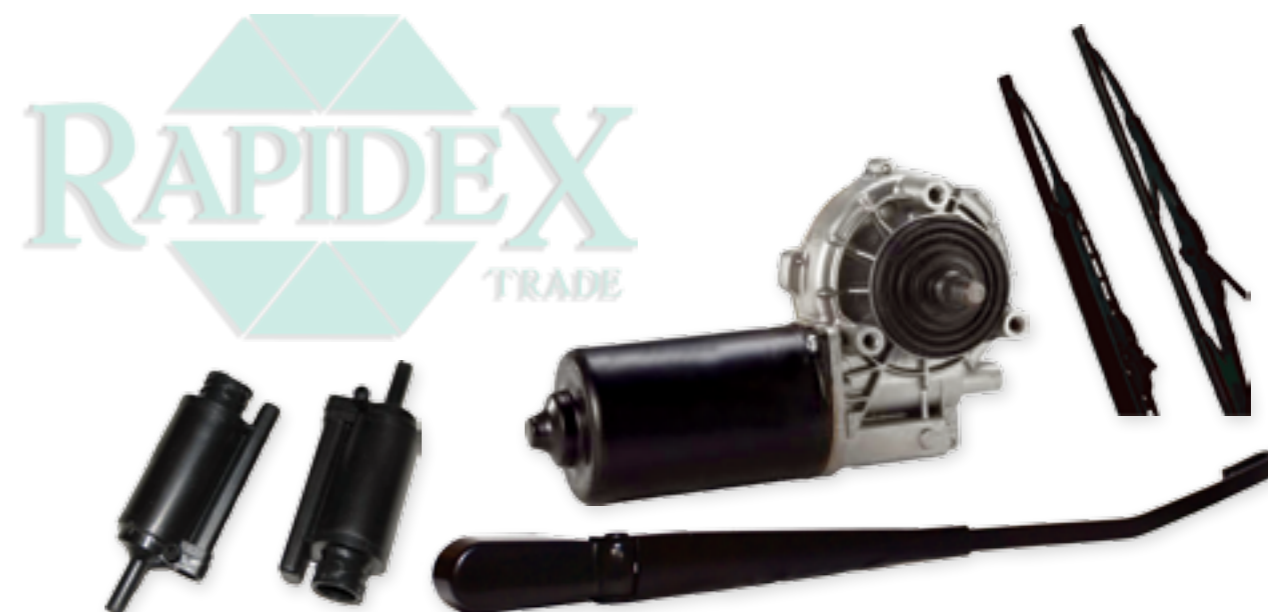

UREĐAJI ZA PRANJE VETROBRANSKOG STAKLA				
Poz.	Model	Opis	OE broj	RAPIDEX broj
1.	ACTROS	MEHANIZAM BRISAČA	941 820 02 41	KABI0647
2.	ACTROS	MEHANIZAM BRISAČA	941 820 04 41	KABI0623
3.	SPRINTER	SET METLICA BRISAČA 650/600	-	KABI1077
4.	ATEGO	METLICA BRISAČA 650 mm	001 820 11 45	KABI0426
5.	ACTROS, SK	METLICA BRISAČA 700 mm	001 820 12 45	KABI0349
6.	ACTROS	METLICA BRISAČA 700 mm VISIOFLEX	-	KABI0789
7.	SK	MOTOR BRISAČA	004 820 67 42	ELEK0168
8.	ACTROS	MOTOR BRISAČA	005 820 21 42	KABI0460
9.	ACTROS	RUČICA BRISAČA	941 820 07 44	KABI0076
10.	ACTROS	RUČICA BRISAČA	941 820 09 44	KABI0037
11.	AXOR	RUČICA BRISAČA	001 820 37 44	KABI0640
12.	ACTROS	PUMPICA BRISAČA	000 869 40 21	OPRE0017
13.	SK	PUMPICA BRISAČA	000 860 32 26	KABI0634

MEHANIZAM VRATA

Poz.	Model	Opis	Položaj	OE broj	RAPIDEX broj
1.	ACTROS KABINA 943	BRAVA VRATA	◀	943 720 06 35	KABI0662
2.	ACTROS KABINA 943	BRAVA VRATA	▶	943 720 07 35	KABI0663
3.	ACTROS KABINA 944	BRAVA VRATA	◀	973 720 07 35	KABI0664
4.	ACTROS KABINA 944	BRAVA VRATA	▶	973 720 08 35	KABI0665
5.	ACTROS	KVAKA VRATA	◀	941 760 04 59	KABI0070
6.	ACTROS	KVAKA VRATA	▶	941 760 05 59	KABI0071
7.	ATEGO, ACTROS	CILINDAR KVAKE	◀▶	670 760 02 05	KABI0315
8.	ACTROS	MOTOR PODIZAČA	◀	005 820 90 42	KABI0309
9.	ACTROS	MOTOR PODIZAČA	▶	005 820 91 42	KABI0310
10.	ACTROS MP II	MOTOR PODIZAČA	◀	000 820 28 08	ELEK0911

MEHANIZAM VRATA

Poz.	Model	Opis	Položaj	OE broj	RAPIDEX broj
11.	ACTROS MP II	MOTOR PODIZAČA	▶	000 820 29 08	ELEK0986
12.	ACTROS KABINA 944	PODIZAČ PROZORA	◀	973 720 01 46	KABI0678
13.	ACTROS KABINA 944	PODIZAČ PROZORA	▶	973 720 02 46	KABI0679
14.	ACTROS KABINA 943	PODIZAČ PROZORA	◀	973 720 03 46	KABI0680
15.	ACTROS KABINA 943	PODIZAČ PROZORA	▶	973 720 04 46	KABI0046
16.	ACTROS KABINA 942/943	PODIZAČ PROZORA	◀	941 720 04 46	KABI0435
17.	ACTROS KABINA 942/943	PODIZAČ PROZORA	▶	941 720 05 46	KABI0072
18.	ACTROS KABINA 942/943	PODIZAČ PROZORA	◀	000 725 00 02	KABI0073
19.	ACTROS KABINA 942/943	PODIZAČ PROZORA	▶	000 725 01 02	KABI0681
20.	ACTROS KABINA 930/931/932/933	RUČICA VRATA	◀	941 890 04 72	KABI0700
21.	ACTROS KABINA 930/931/932/933	RUČICA VRATA	▶	941 890 05 72	KABI0701
22.	ACTROS KABINA 942	RUČICA VRATA	◀	941 720 00 66	KABI0074
23.	ACTROS KABINA 942	RUČICA VRATA	▶	941 720 01 66	KABI0075
24.	ATEGO, ACTROS	GRANIČNIK VRATA	◀	973 720 14 16	KABI0188
25.	ATEGO, ACTROS	GRANIČNIK VRATA	▶	973 720 15 16	KABI0189
26.	AXOR, ACTROS	GRANIČNIK VRATA	◀▶	941 720 01 16	KABI0187
27..	AXOR, ACTROS	GRANIČNIK VRATA	◀▶	941 720 01 16	KABI0187

7.0 ELEKTRIČNE INSTALACIJE



7.0 ELEKTRIČNE INSTALACIJE

7.1	Farovi	244
7.2	Pokazivači pravca	251
7.3	Stop i gabaritna svetla	253
7.4	Rotacione lampe	258
7.5	Sijalice, osigurači i tahograf listići	261
7.6	Kablovi električne instalacije	266
7.7	Kombinovani prekidači pod volanom	269
7.8	Akumulatori i pribor	270
7.9	Anlaseri i alternatori	274

SPRINTER (1995 - 2000)

OE broj	OPIS	RAPIDEX broj
901 820 06 61	▶	RASV0409
901 820 05 61	◀	RASV0408
901 820 02 61	▶	RASV0637
901 820 01 61	◀	RASV0638
000 820 17 66	▶ STAKLO	RASV0639
000 820 16 66	◀ STAKLO	RASV0640

SPRINTER (2000 - 2002)

OE broj	OPIS	RAPIDEX broj
901 820 15 61	▶	RASV0641
901 820 14 61	◀	RASV0642
901 820 11 61	▶	RASV0254
901 820 10 61	◀	RASV0523

SPRINTER (2002 - 2004)

OE broj	OPIS	RAPIDEX broj
901 820 27 61	▶	RASV0328
901 820 26 61	◀	RASV0327
901 820 25 61	▶	RASV0643
901 820 24 61	◀	RASV0644

SPRINTER (2005 - ...)

OE broj	OPIS	RAPIDEX broj
906 820 02 61	▶	RASV0645
906 820 01 61	◀	RASV0646

SPRINTER (2005 - ...)

OE broj	OPIS	RAPIDEX broj
211 820 06 56	▶	RASV0647
211 820 05 56	◀	RASV0648

VARIO (1996 - ...)



OE broj	OPIS	RAPIDEX broj
670 820 06 61	▶	RASV0649
670 820 05 61	◀	RASV0650

ATEGO I (1998 - 2004)

OE broj	OPIS	RAPIDEX broj
973 820 02 61	▶	RASV0653
973 820 01 61	◀	RASV0654
973 820 06 61	▶	RASV0330
973 820 05 61	◀	RASV0329
004 826 12 90	▶ STAKLO	RASV0016
004 826 13 90	◀ STAKLO	RASV0655

ATEGO II (2004 - ...)

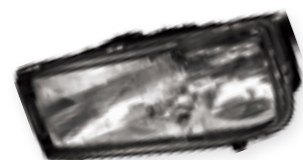
OE broj	OPIS	RAPIDEX broj
973 820 23 61	▶	RASV0656
973 820 22 61	◀	RASV0657
973 820 25 61	▶	RASV0658
973 820 24 61	◀	RASV0659
000 826 45 10	▶ STAKLO	RASV0660
000 826 44 10	◀ STAKLO	RASV0661

**AXOR I (2001 - 2004)
ACTROS (1996 - 2003)**

OE broj	OPIS	RAPIDEX broj
941 820 58 61	▶ H4	RASV0665
941 820 57 61	◀ H4	RASV0666
941 820 52 61	▶ H4 H1	RASV1018
941 820 51 61	◀ H4 H1	RASV1017
941 820 60 61	▶ H4 H1	RASV0667
941 820 59 61	◀ H4 H1	RASV0668



941 820 54 61	▶ H4	RASV1022
941 820 53 61	◀ H4	RASV1021
941 820 56 61	▶ H4	RASV0669
941 820 55 61	◀ H4	RASV0670

004 826 07 90	▶ STAKLO	RASV0470
004 826 06 90	◀ STAKLO	RASV0342



002 820 59 56	▶ H3	RASV0671
002 820 58 56	◀ H3	RASV0672
002 820 52 56	▶ H3	RASV0673
002 820 45 56	◀ H3	RASV0674



002 820 7756	▶ H3	RASV0285
002 820 7656	◀ H3	RASV0284
002 820 85 56	▶ H3	RASV0179
002 820 84 56	◀ H3	RASV0176
000 826 18 59	▶	RASV0174
000 826 17 59	◀	RASV0210

AXOR II (2004 - ...)

OE broj	OPIS	RAPIDEX broj
940 820 02 61	▶ H7 H1	RASV0662
940 820 01 61	◀ H7 H1	RASV0663
940 820 04 61	▶ H7 H1	RASV1243
940 820 03 61	◀ H7 H1	RASV1244
000 826 43 10	▶ STAKLO	RASV0341
000 826 42 10	◀ STAKLO	RASV0664

AXOR II (2004 - ...)

OE broj	OPIS	RAPIDEX broj
940 820 01 56	▶ H3	RASV1248
940 820 00 56	◀ H3	RASV1247

ACTROS (2003 - ...)

OE broj	OPIS	RAPIDEX broj
943 820 02 61	▶ H7 H1	RASV1024
943 820 01 61	◀ H7 H1	RASV1023
943 820 04 61	▶ H7 H1	RASV0676
943 820 03 61	◀ H7 H1	RASV0677
-	▶ STAKLO	RASV1122
-	◀ STAKLO	ELEK1468



943 820 01 56	▶ H3	RASV1026
943 820 00 56	◀ H3	RASV1025

ACTROS (2008 - ...)

OE broj	OPIS	RAPIDEX broj
943 820 17 61	▶ H7 H1	RASV0678
943 820 16 61	◀ H7 H1	RASV0679
943 820 23 61	▶ XENON D1S H1	RASV0680
943 820 22 61	◀ XENON D1S H1	RASV0681
000 826 47 10	▶ STAKLO	RASV1181
000 826 46 10	◀ STAKLO	RASV1182

ACTROS (2011 - ...)

OE broj	OPIS	RAPIDEX broj
960 820 11 39	▶ H7 H1	RASV1322
960 820 10 39	◀ H7 H1	RASV1323
960 820 13 39	▶ H7 H1	RASV1324
960 820 12 39	◀ H7 H1	RASV1325
960 820 15 39	▶ XENON D1S H1	RASV1338
960 820 14 39	◀ XENON D1S H1	RASV1339
960 820 17 39	▶ XENON D1S H21W H1	RASV1340
960 820 16 39	◀ XENON D1S H21W H1	RASV1341

UNIVERZALNI FAR

KBP	OPIS	RAPIDEX broj
1G3 005 760-021	▶ H3 ◀ H3 Ø152 mm	RASV0718

UNIVERZALNI FAR

KBP	OPIS	RAPIDEX broj
1GA 005 060-001	▶ H3 ◀ H3 153 x 93 mm	RASV0230



UNIVERZALNI FAR

KBP	OPIS	RAPIDEX broj
1GA 006 991-021	▶ H3 ◀ H3 158 x 105 mm	RASV0719

UNIVERZALNI FAR

KBP	OPIS	RAPIDEX broj
1GA 006 991-081 44.120.000	▶ H3 ◀ H3 112 x 102mm	RASV0168

UNIVERZALNI FAR

KBP	OPIS	RAPIDEX broj
44.040.500	  170 x 100 mm	RASV0167



LED UNIVERZALNI FAR



KBP	OPIS	RAPIDEX broj
91017420	 LED 9-30 V, 1200 LUMEN 105 x 124	RASV0546



LED UNIVERZALNI FAR

KBP	OPIS	RAPIDEX broj
098174090	 LED 9-30 V, 1200 LUMEN 140 x 114	RASV1342

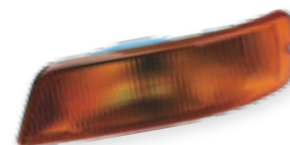

SPRINTER (1995 - 2000)



OE broj	OPIS	RAPIDEX broj
901 820 02 21		RASV0089
901 820 01 21		RASV0088



ATEGO I (1998 - 2004)

OE broj	OPIS	RAPIDEX broj
973 820 02 21		RASV0015
973 820 01 21		RASV0033

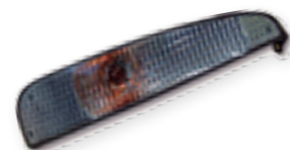
ATEGO II (2004 - ...)

OE broj	OPIS	RAPIDEX broj
973 820 06 21		RASV0122
973 820 05 21		RASV0121

AXOR II (2004 - ...)

OE broj	OPIS	RAPIDEX broj
940 820 04 21		RASV0735
940 820 03 21		RASV0736

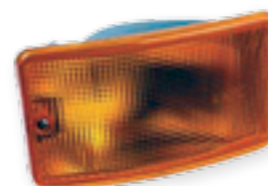
**ACTROS (1996 - 2003)
AXOR I (2001 - 2004)**

OE broj	OPIS	RAPIDEX broj
941 820 07 21		RASV0737

MK, SK (1988 - ...)



OE broj	OPIS	RAPIDEX broj
001 820 44 21	▶	RASV0370
001 820 43 21	◀	RASV0745

ATEGO I 1998 - 2004



OE broj	OPIS	RAPIDEX broj
973 820 04 21	▶	KABI0106
973 820 03 21	◀	KABI0770



941 820 10 21	▶	RASV0746
	◀	

AXOR (2002 - ...)

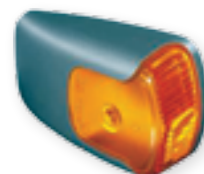

OE broj	OPIS	RAPIDEX broj
940 820 02 21	▶	RASV0178
	◀	

ACTROS (1996 - 2003)



OE broj	OPIS	RAPIDEX broj
941 820 09 21	▶	RASV0354
941 820 05 21	◀	RASV0353



942 820 09 21	▶	RASV0115
941 820 05 21	◀	RASV0376

208D - 410D, 507D - 814D

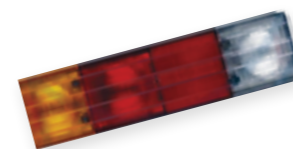

OE broj	OPIS	RAPIDEX broj
002 544 08 03	▶	RASV0124
002 544 09 03	◀ 425 x 110 mm	RASV0754

SPRINTER (1995 - ...)

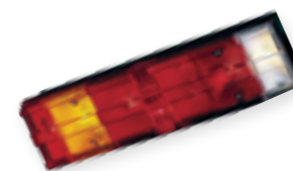

OE broj	OPIS	RAPIDEX broj
002 544 54 03	▶	RASV0243
002 544 55 03	◀ 465 x 134 mm	RASV0242
002 544 47 90	▶ STAKLO	RASV0239
	◀ STAKLO	

SPRINTER 1995-2006



OE broj	OPIS	RAPIDEX broj
000 826 08 56	▶	RASV1362
000 826 07 56	◀	RASV1185

SPRINTER 2002-2005







OE broj	OPIS	RAPIDEX broj
000 826 16 56	▶	RASV1363
000 826 15 56	◀	RASV1364

SPRINTER (2005 - ...)







OE broj	OPIS	RAPIDEX broj
906 820 02 64	▶	RASV1014
906 820 01 64	◀	RASV1013





SPRINTER (2006 - ...)

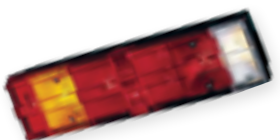

OE broj	OPIS	RAPIDEX broj
906 820 17 64	▶  400 x 160 mm	RASV0298
906 820 04 64	◀  400 x 160 mm	RASV0755
906 826 21 56	▶ STAKLO 	RASV0305
906 826 20 56	◀ STAKLO 	RASV0297





MK, SK (1988 - ...)

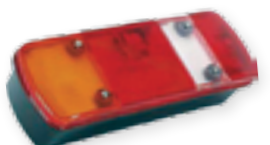

OE broj	OPIS	RAPIDEX broj
001 540 20 70	▶  525 x 139 mm	RASV0397
001 540 17 70	◀  525 x 139 mm	RASV0225
002 544 07 90	▶ STAKLO 	RASV0028
002 544 06 90	◀ STAKLO 	RASV0029



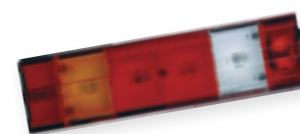

ATEGO I (1998 - 2004)

OE broj	OPIS	RAPIDEX broj
003 544 54 03	▶  465 x 134 mm	RASV0241
003 544 53 03	◀  465 x 134 mm	RASV0240
002 544 47 90	▶ STAKLO 	RASV0239
	◀ STAKLO 	





ATEGO II (2005 - ...)

OE broj	OPIS	RAPIDEX broj
002 544 71 03	▶  340 x 130 mm	RASV0756
002 544 70 03	◀  340 x 130 mm	RASV0757
002 544 61 90	▶ STAKLO 	RASV0758
	◀ STAKLO 	

ACTROS (1996 - ...), AXOR (2001 - ...)

OE broj	OPIS	RAPIDEX broj
001 540 58 70	▶  525 x 139 mm	RASV0977
001 540 57 70	◀  525 x 139 mm	RASV0976
002 544 07 90	▶ STAKLO 	RASV0028
002 544 06 90	◀ STAKLO 	RASV0029

ACTROS (2011 - ...)

OE broj	OPIS	RAPIDEX broj
003 544 08 03	▶  525 x 139 mm	RASV1346
003 544 10 03	▶  + RIKVERC ALARM	RASV1350
003 544 19 03	▶ LED	RASV1348
003 544 21 03	▶ LED + RIKVERC ALARM	RASV1351
003 544 17 03	◀	RASV1347
003 544 20 03	◀ LED	RASV1349
002 544 73 90	▶ STAKLO 	RASV1352
	◀ STAKLO 	

RIKVERC ALARMI

Poz.	Slika	Naziv / Opis	RAPIDEX broj
1.		RIKVERC ALARM 12/24 V, 97 dB	OSTA0370
2.		RIKVERC ALARM 12/24 V, 97 dB	OSTA0247

MK, NG, SK, ACTROS MP I, II

OE broj	OPIS	RAPIDEX broj
000 820 00 56	▶  12/24V	RASV0412
	◀ 5WSV8,5	

ACTROS MP I, II, III

OE broj	OPIS	RAPIDEX broj
943 820 06 56	▶  24V	RASV1199
	◀ LED	



ATEGO I (1998 - 2004), ATEGO II (2004 - ...)

OE broj	OPIS	RAPIDEX broj
002 820 69 56	▶  24V	RASV0838
002 820 68 56	◀ 10W Ba 15s	RASV0839



OE broj	OPIS	RAPIDEX broj
002 820 51 56	▶  24V	RASV0840
002 820 50 56	◀ 10W Ba 15s	RASV0841

ATEGO, AXOR, ACTROS MP I, II, III

OE broj	OPIS	RAPIDEX broj
000 544 54 11	▶  24V	RASV0026
	◀ W3W-W2,1X9,5D	



OE broj	OPIS	RAPIDEX broj
000 544 58 11	▶  LED	RASV0842

SVETLA REGISTRAR TABLICE

KBP	OPIS	RAPIDEX broj
2KA 003 389-061	▶ 12/24V	RASV0396
	◀ R10W-Ba15s	



KBP	OPIS	RAPIDEX broj
26-3010-004	▶ 12/24V	RASV0075
	◀ C5W-SV8,5	



KBP	OPIS	RAPIDEX broj
26-3000-004	▶ 12/24V	RASV0105
	◀ C5W-SV8,5	



KBP	OPIS	RAPIDEX broj
39.280.000	▶ LED	RASV0860
	◀	

KATADIOPTERI

KBP	OPIS	RAPIDEX broj
8RA 002 014-041	BELI	Ø 60 mm
8RA 002 014-051	ŽUTI	
8RA 002 014-031	CRVENI	



KBP	OPIS	RAPIDEX broj
8RA 003 326-021	BELI	94 x 44 mm
8RA 003 326-011	ŽUTI	
8RA 003 326-001	CRVENI	



KBP	OPIS	RAPIDEX broj
01.090.7520.05		RASV0222



KL 7000 F

KBP	OPIS		RAPIDEX broj
2RL 008 061-101	12V		RASV0862
2RL 008 061-111	24V		RASV0863
9EL 862 141-001	ŽUTO STAKLO		RASV0864
9EL 862 140-001	PLAVO STAKLO		RASV0865

KL 7000 M

KBP	OPIS		RAPIDEX broj
2RL 008 062-101	12/24V		RASV0866
2RL 008 062-111	24/12V		RASV0867
9EL 862 141-001	ŽUTO STAKLO		RASV0864
9EL 862 140-001	PLAVO STAKLO		RASV0865

KL 7000 M

KBP	OPIS		RAPIDEX broj
2RL 008 062-001	12/24V		RASV0868
2RL 008 062-011	24/12V		RASV0869
9EL 862 141-001	ŽUTO STAKLO		RASV0864
9EL 862 140-001	PLAVO STAKLO		RASV0865

KL 7000 R

KBP	OPIS		RAPIDEX broj
2RL 008 060-101	12/24V		RASV0870
2RL 008 060-111	24/12V		RASV0871
9EL 862 141-001	ŽUTO STAKLO		RASV0864
9EL 862 140-001	PLAVO STAKLO		RASV0865

JUNIOR PLUS F

KBP	OPIS		RAPIDEX broj
2RL 008 965-001	12V		RASV0467
2RL 008 965-011	24V		RASV0872
9EL 863 100-001	ŽUTO STAKLO		RASV0873

JUNIOR F

KBP	OPIS		RAPIDEX broj
2RL 007 550-001	12V		RASV0533
2RL 007 550-011	24V		RASV0558
9EL 860 627-001	ŽUTO STAKLO		RASV0505
9EL 860 628-021	PLAVO STAKLO		RASV0874

JUNIOR M

KBP	OPIS	RAPIDEX broj
2RL 007 552-001	12V	H1 RASV0560
2RL 007 552-011	24V	

9EL 860 627-001	ŽUTO STAKLO	RASV0505
9EL 860 628-021	PLAVO STAKLO	RASV0874

JUNIOR R

KBP	OPIS	RAPIDEX broj
2RL 007 551-001	12V	H1 RASV0055
2RL 007 551-011	24V	

9EL 860 627-001	ŽUTO STAKLO	RASV0505
9EL 860 628-021	PLAVO STAKLO	RASV0874

H1 - P14,5s

OPIS	RAPIDEX broj
12V H1-55W	RASV1089
24V H1-70W	RASV1088

H2 - H511

OPIS	RAPIDEX broj
12V H2-55W	RASV0880
24V H2-70W	RASV0881

H3 - PK22s

OPIS	RAPIDEX broj
12V H3-55W	RASV1105
24V H3-70W	ELEK0294

H4 - P43t

OPIS	RAPIDEX broj
12V H4-60/55W	RASV1085
24V H4-75/70W	ELEK0295

H7 - Px26d

OPIS	RAPIDEX broj
12V H7-55W	RASV1084
24V H7-70W	RASV1078

H8 - PGJ19-1

OPIS	RAPIDEX broj
12V H8-35W	RASV0882

H9 - PGJ19-5

OPIS	RAPIDEX broj
12V H9-55W	RASV0877

H10 - PY20d

OPIS	RAPIDEX broj
12V H10-42W	RASV0883

H11 - PGJ19-2

OPIS	RAPIDEX broj
12V H11-55W	RASV0878
24V H11-70W	RASV0879

H21W - BAY9s

OPIS	RAPIDEX broj
12V H21W	RASV0884
24V H21W	RASV1079

D2R - P32d3

OPIS	RAPIDEX broj
D2R-35W	RASV0885

D2S - P32d2

OPIS	RAPIDEX broj
D2S-35W	RASV0886

R2 - P45t

OPIS	RAPIDEX broj
12V R2-45/40W	RASV0550
24V R2-55/50W	RASV0571

P21W - BA15s

OPIS	RAPIDEX broj
12V P21W	RASV1083
24V P21W	ELEK0293

PY21W - BAU15s

OPIS	RAPIDEX broj
12V PY21W	RASV0562
24V PY21W	RASV0499

P21/5W - BAY15d

OPIS	RAPIDEX broj
12V P21/5W	RASV0535
24V P21/5W	RASV1076

R5W - BA15s

OPIS	RAPIDEX broj
12V R5W	RASV1082
24V R5W	RASV1072

R10W - BA15s

OPIS	RAPIDEX broj
12V R10W	RASV0490
24V R10W	RASV1075

C5W - SV8,5

OPIS	RAPIDEX broj
12V C5W	RASV0887
24V C5W	RASV1074

C10W - SV8,5

OPIS	RAPIDEX broj
12V C10W	RASV0888
24V C10W	RASV0315

T3W - BA9s

OPIS	RAPIDEX broj
12V T3W	RASV0502
24V T3W	RASV0501

T4W - BA9s

OPIS	RAPIDEX broj
12V T4W	ELEK0291
24V T4W	RASV1071

W3W - W2,1x9,5d

OPIS	RAPIDEX broj
12V W3W	RASV0564
24V W3W	RASV0569

W5W - W2,1x9,5d

OPIS	RAPIDEX broj
12V W5W	RASV0484
24V W5W	RASV1073

W1,2W - W2x4,6d

OPIS	RAPIDEX broj
12V W1,2W	RASV0563
24V W1,2W	RASV1069

W1,2W - B8,3d

OPIS	RAPIDEX broj
12V W1,2W	RASV0893
24V W1,2W	RASV1070

GARNITURA SIJALICA H7

OPIS	RAPIDEX broj
12V H7	RASV1180
24V H7	RASV1081

GARNITURA SIJALICA H4

OPIS	RAPIDEX broj
12V H4	RASV1086
24V H4	RASV1080

GARNITURA SIJALICA H7

OPIS	RAPIDEX broj
2 x 24V H7	RASV0892

GARNITURA SIJALICA H4

OPIS	RAPIDEX broj
2 x 24V H4	RASV0895

OSIGURAČI UBODNI

Slika	Poz.	Opis	KBP	RAPIDEX broj
	1.	5A OKER	8JS 711 684-002	ELEK0684
	2.	7,5A BRAON	8JS 711 685-002	ELEK0258
	3.	10A CRVENI	8JS 711 686-002	RASV0568
	4.	15A PLAVI	8JS 711 687-002	RASV0567
	5.	20A ŽUTI	8JS 711 688-002	ELEK0257
	6.	25A BELI	8JS 711 689-002	ELEK0575
	7.	30A ZELENI	8JS 711 690-002	RASV0539
	8.	40A NARANDŽASTI	8JS 711 683-031	ELEK0769

OSIGURAČI UBODNI - MINI

Slika	Poz.	Opis	KBP	RAPIDEX broj
	1.	5A	8JS 728 596-131	RASV0183
	2.	7,5A	8JS 728 596-111	RASV0184
	3.	10A	8JS 728 596-141	RASV0185
	4.	15A	8JS 728 596-151	RASV0186
	5.	20A	8JS 728 596-161	RASV0187
	6.	25A	8JS 728 596-091	RASV0188
	7.	30A	8JS 728 596-171	RASV0189

OSIGURAČI UBODNI - MAXI

Slika	Poz.	Opis	KBP	RAPIDEX broj
	1.	20A	8JS 728 595-051	RASV0920
	2.	30A	8JS 728 595-141	RASV0921
	3.	40A	8JS 728 595-151	RASV0922
	4.	50A	8JS 728 595-161	RASV0923
	5.	60A	8JS 728 595-171	RASV0924
	6.	70A	8JS 728 595-101	RASV0925
	7.	80A	8JS 728 595-111	RASV0927

OSIGURAČI - MIDI

Slika	Poz.	Opis	KBP	RAPIDEX broj
	1.	30A	8JS 742 901-061	RASV0928
	2.	50A	8JS 742 901-011	RASV0929
	3.	150A	8JS 742 901-081	RASV0052

OSIGURAČI - MEGA

Slika	Poz.	Opis	KBP	RAPIDEX broj
	1.	125A	8JS 742 902-011	RASV0930
	2.	150A	8JS 742 902-021	RASV0931
	3.	200A	8JS 742 902-041	RASV0932
	4.	250A	8JS 742 902-051	RASV0933
	5.	300A	8JS 742 902-071	RASV0934

TAHOGRAF LISTIĆI

Slika	Poz.	Opis	RAPIDEX broj
	1.	100-24 EC4K	OPRE0210
	2.	100-3300-24 EC4	OPRE0220
	3.	125-24 EC4K	OPRE0224
	4.	125-3300-24 EC4KA	OPRE0122
	5.	140-24 EC4K	OPRE0216
	6.	SERTIFIKAT-VIKEND	OPRE0105
	7.	ROLNICA ZA DIGITALNI TAHOGRAF	ELEK1112



SPIRALNI KABLOVI				
Slika	Poz.	Opis	KBP	RAPIDEX broj
	1.	7 - ŽILNI	611 110	ELEK0609
	2.	ISO 1724 7 - lni	8KA 004 797-021	ELEK0770
	3.	ISO 1185 7 - lni	8KA 004 797-041	ELEK0287
	4.	ISO 3731 7 - lni	8KA 004 797-051	ELEK0370
	5.	ISO 7638 ABS/EBS	446 008 700 0	ELEK1368
	6.	ISO 12098 15 - lni	446 008 710 0	ELEK1122
	7.	15/2 x 7 - lni	8JA 005 952-041	ELEK0450

ADAPTER				
Slika	Poz.	Opis	KBP	RAPIDEX broj
	1.	15/2 x 7 - lin	8JA 005 952-061	ELEK0247

UTIKAČI				
Slika	Poz.	Opis	KBP	RAPIDEX broj
	1.	ISO 1724 7 - lni 12V	8JA 001 930-003	ELEK0607
	2.	ISO 1185 7 - lni	8JA 008 831-001	RASV0541
	3.	ISO 3731 7 - lni	8JA 008 832-011	ELEK0491
	4.	ISO 7638 ABS/EBS	8JB 007 645-031	ELEK0470
	5.	ISO 12098 15 - lni	8JA 007 241-031	ELEK0250

UTIČNICE				
Slika	Poz.	Opis	KBP	RAPIDEX broj
	1.	ISO 1724 7 - Ini 12V	8JB 001 943-003	ELEK0606
	2.	ISO 1185 7 - Ini	8JB 003 833-001	RASV0513
	3.	ISO 3731 7 - Ini	8JB 003 834-001	RASV0452
	4.	ISO 7638 ABS/EBS	8JB 007 645-031	ELEK0402
	5.	ISO 12098 15 - Ini	8JB 007 242-011	ELEK0249

KOMBINOVANI PREKIDAČI POD VOLANOM				
Poz.	Slika	Model	OE broj	RAPIDEX broj
1.		NG, O303, O404	005 545 51 24	ELEK0658
2.		NG, SK, O404	620 540 00 45	ELEK0666
3.		SK, MK	655 540 00 45	ELEK0254
4.		ACTROS, ATEGO, AXOR	008 545 01 24	ELEK0001
5.		CITARO, NEOPLAN, EVOBUS	002 540 62 44	ELEK0108
6.		O405, O407, O408	357 540 00 45	ELEK0793
7.		O405, O407, O408	357 540 95 45	ELEK0007

VARTA

BY JOHNSON CONTROLS



Skraćenica	Volt	Ah	Dužina (mm)	Širina (mm)	Visina (mm)	A	Spoj	Polovi	Podna prirubnica	RAPIDEX broj
12w	12	110	514	175	210	760	3	1	B03	ELEK1161
J2w	12	125	345	172	290	720	1	1	B00	OPRE0246
K8	12	140	513	189	223	800	3	1	B03	ELEK0837
K4w	12	143	514	218	210	950	3	1	B03	OPRE0250
M8	12	170	513	223	223	1000	3	1	B00	OPRE0233
M18	12	180	513	223	223	1000	3	1	B00	OPRE0251
N9	12	225	518	276	242	1150	3	1	B00	OPRE0529

TEHNIČKO OBJAŠNJENJE:

Položaji polova

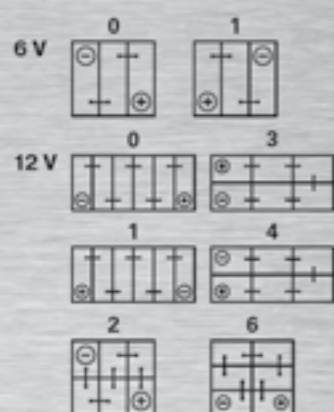

Podna prirubnica

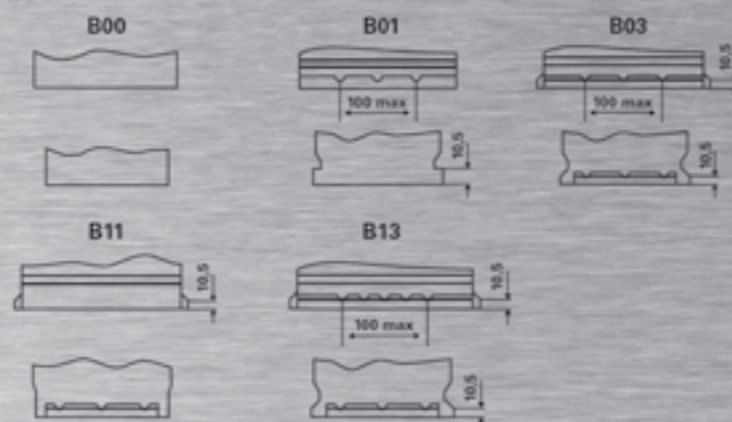

PRIBORI

Slika	Opis	RAPIDEX broj
	Kablovi za startovanje 25 mm ² x 3,5 m	ELEK0554
	Kablovi za startovanje 35 mm ² x 4,5 m	ELEK0703
	Kablovi za startovanje 50 mm ² x 7 m	ELEK0704
	Kontakt klešta 25 - 50 mm ²	ELEK0705
	Klemna +	ELEK0640
	Klemna -	ELEK0600
	Merač kiseline	ELEK0706

ProAtomic akumulatori

Snaga atoma.



- Optimalno prilagođena snaga za starija i novija vozila.
- Bez dodatnog održavanja.
- Izuzetno prihvatljiva cena.
- Paleta putničkih i teretnih akumulatora.
- 30 meseci garancije.

ProAtomic
BY JOHNSON CONTROLS

AKUMULATORI

Oznaka ETN	Skraćenica	Kapacitet	Struja pri hladnom stanju	Dužina (mm)	Širina (mm)	Visina (mm)	Sistem vezivanja	Priključni polovi	Podna prirubnica	RAPIDEX broj
535119030	L35	35	300	187	127	227	1	3	B00	OPRE0252
540406034	D40	40	340	175	175	190	0	1	B13	OPRE0253
545412040	D45	45	400	207	175	190	0	1	B13	OPRE0254
545413040	L45	45	400	207	175	190	1	1	B13	OPRE0091
556400048	D56	56	480	242	175	190	0	1	B13	OPRE0255
556401048	L56	56	480	242	175	190	1	1	B13	OPRE0237
560408054	D60	60	540	242	175	190	0	1	B13	OPRE0256
560127054	L60	60	540	242	175	190	1	1	B13	OPRE0257
574012068	D74	74	680	278	175	190	0	1	B13	OPRE0258
583400072	D83	83	720	353	175	175	0	1	B13	OPRE0259
595402080	D95	95	800	353	175	190	0	1	B01	OPRE0201
610013076	L110	110	760	514	175	210	3	1	B00	OPRE0159
640135076	L140	140	950	513	189	223	3	1	B00	OPRE0187
670043100	L170	170	1000	513	223	223	3	1	B00	OPRE0156
720025145	L220	225	1450	518	291	242	3	1	B01	OPRE0235

Sistem vezivanja

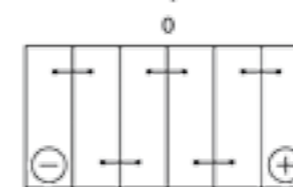

1

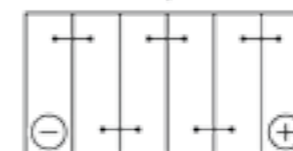

Priključni polovi



Podna prirubnica

B00

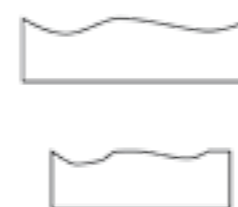

B01

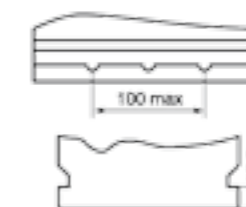

B13

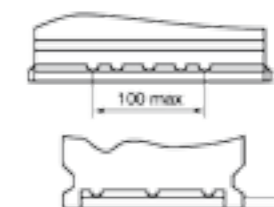

SPRINTER

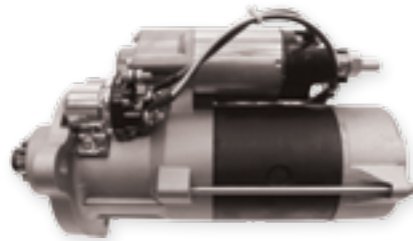
Slika	Opis	KBP	OE broj	RAPIDEX broj
	12 V 1,7kW 12 Z	0 986 021 360	006 151 25 01	ELEK01925

ATEGO, AXOR

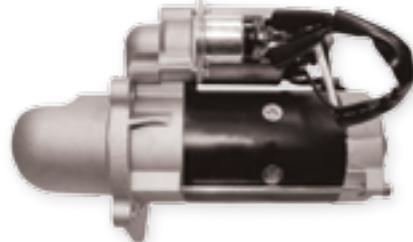
Slika	Opis	KBP	OE broj	RAPIDEX broj
	24 V 4 kW 9 Z	0 001 231 033	004 151 84 01	ELEK0730

MK, SK

Slika	Opis	KBP	OE broj	RAPIDEX broj
	24 V 5,4 kW 9 Z	0 001 416 079	003 151 45 01	ELEK0392

MK, SK

Slika	Opis	KBP	OE broj	RAPIDEX broj
	24 V 6,6 kW 9 Z	0 001 417 001	003 151 46 01	ELEK0782

ACTROS MP I, MP II, MP III

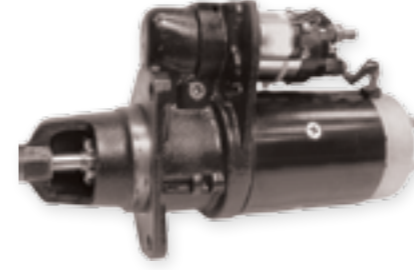
Slika	Opis	KBP	OE broj	RAPIDEX broj
	24 V 6,2 kW 11 Z	0 001 372 001	004 151 94 01	ELEK0775

ACTROS MP I, MP II, MP III

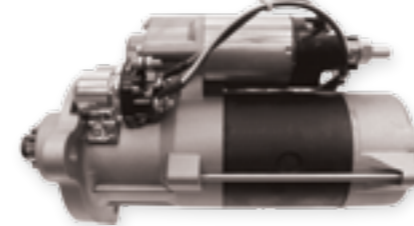
Slika	Opis	KBP	OE broj	RAPIDEX broj
	24 V 7,5 kW 12 Z	M9T80473	005 151 64 01	ELEK1602



ATEGO				
Slika	Opis	KBP	OE broj	RAPIDEX broj
	28V 80A PK8 FI 72 mm	0 120 469 115	009 154 98 02	ELEK0707

ATEGO				
Slika	Opis	KBP	OE broj	RAPIDEX broj
	28V 80A PK8 FI 72 mm 	0 124 555 002	012 154 10 02	ELEK0715

ACTROS				
Slika	Opis	KBP	OE broj	RAPIDEX broj
	28V 80A PK9 FI 77 mm	0 120 469 116	009 154 98 02	ELEK0279

ACTROS				
Slika	Opis	KBP	OE broj	RAPIDEX broj
	28V 80A 	0 124 555 065	012 154 68 02	ELEK1659

ACTROS				
Slika	Opis	KBP	OE broj	RAPIDEX broj
	28V 80A PK9 FI 77 mm 	0 124 555 001	012 154 68 02	ELEK0251
	28V 80A PK11 FI 77 mm 	0 124 555 004	012 154 04 02	ELEK0714

ACTROS				
Slika	Opis	KBP	OE broj	RAPIDEX broj
	28V 100A 	0 124 655 023	013 154 79 02	ELEK1570

8.0 PRIBORI



8.0 PRIBORI

8.1	Obeležavajuće table i pribori A.D.R.	280
8.2	Oprema	295
8.3	Pribor za osiguravanje tereta	298
8.4	Lanci za sneg	300
8.5	Vučne kuke	302
8.6	Grejanje kabine	305

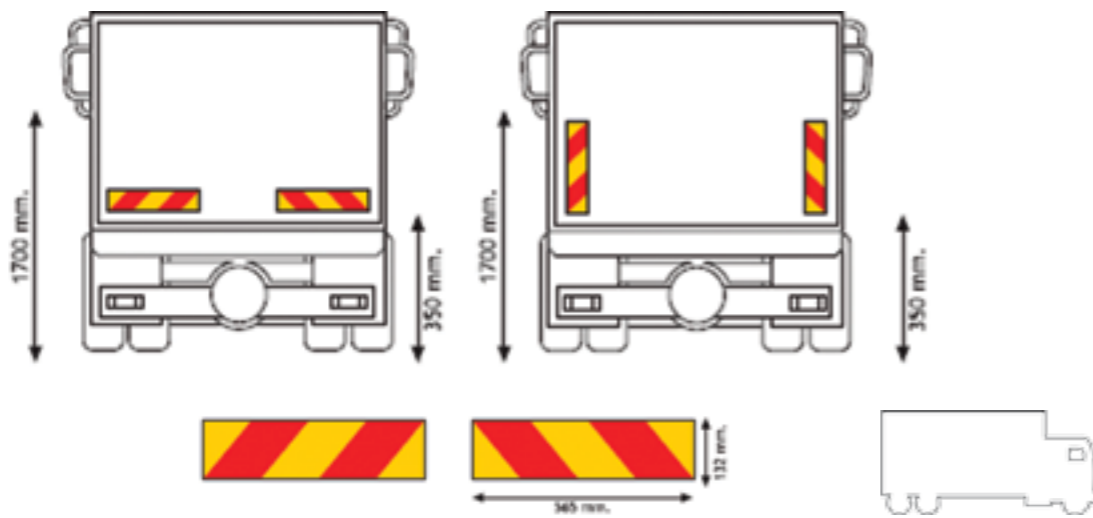
**REFLEKTUJUĆE I FLUOROSCENTNE TABLE ZA KAMIONE
SAGLASNO REGULATIVI ECE 70**

Poz.	Dimenzije (mm)	Opis	Jedinica mere	RAPIDEX broj
1.	565 x 132	Aluminijum	PAR	OPRE097

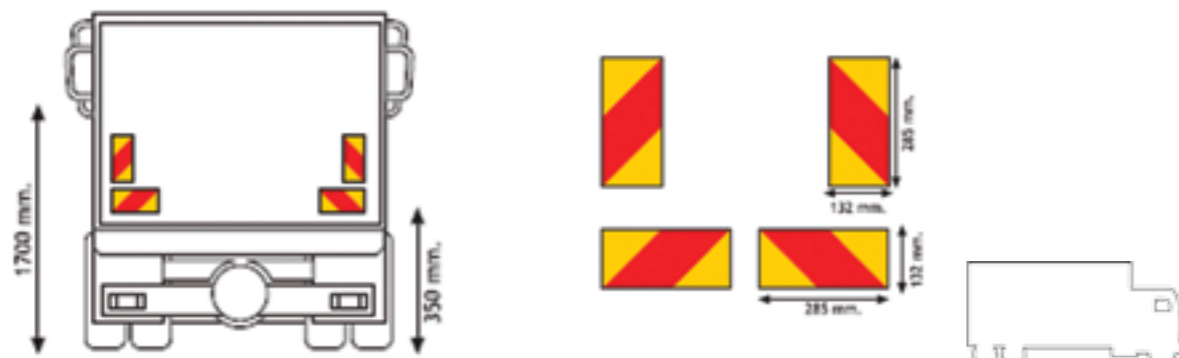

Poz.	Dimenzije (mm)	Opis	Jedinica mere	RAPIDEX broj
2.	285 x 132	Aluminijum	PAR	OPRE0260

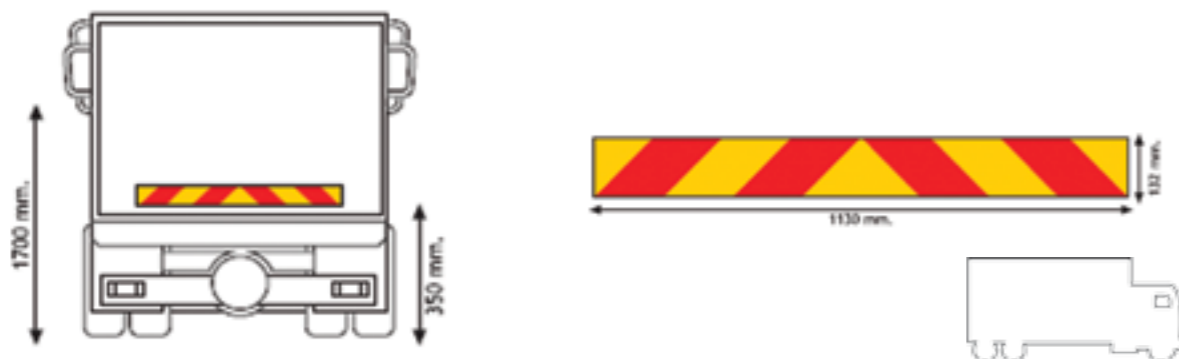

Poz.	Dimenzije (mm)	Opis	Jedinica mere	RAPIDEX broj
3.	1130 x 132	Aluminijum	KOM	OPRE0261

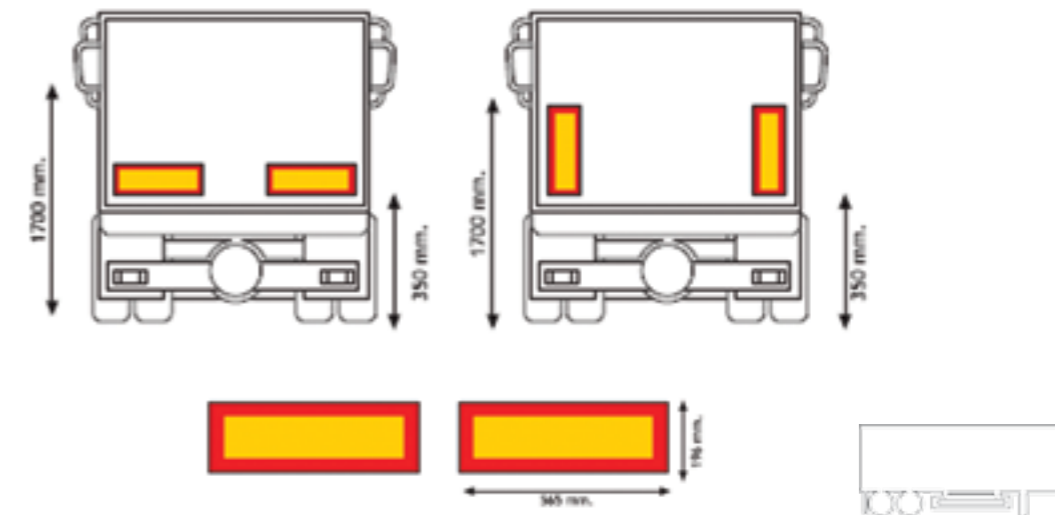
**REFLEKTUJUĆE I FLUOROSCENTNE TABLE ZA KAMIONE
SAGLASNO REGULATIVI ECE 70**

Poz.	Dimenzije (mm)	Opis	Jedinica mere	RAPIDEX broj
1.	565 x 196	Aluminijum	PAR	OPRE0157

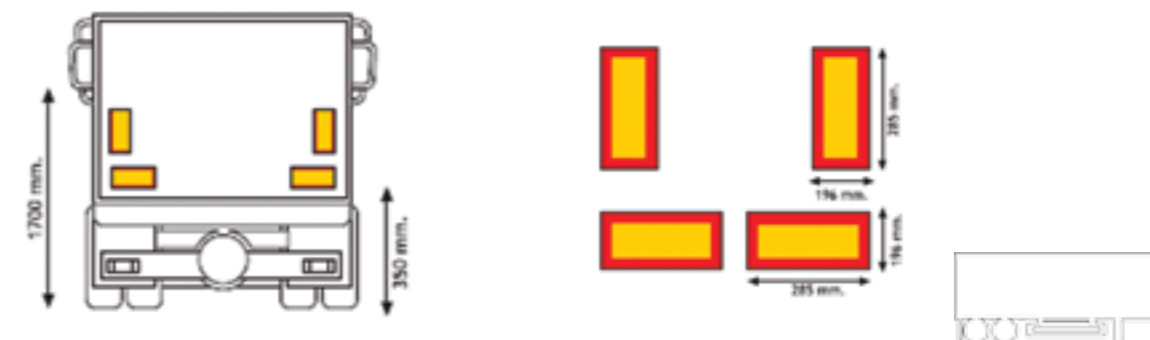

Poz.	Dimenzije (mm)	Materijal	Jedinica mere	RAPIDEX broj
2.	285 x 196	Aluminijum	PAR	OPRE0262

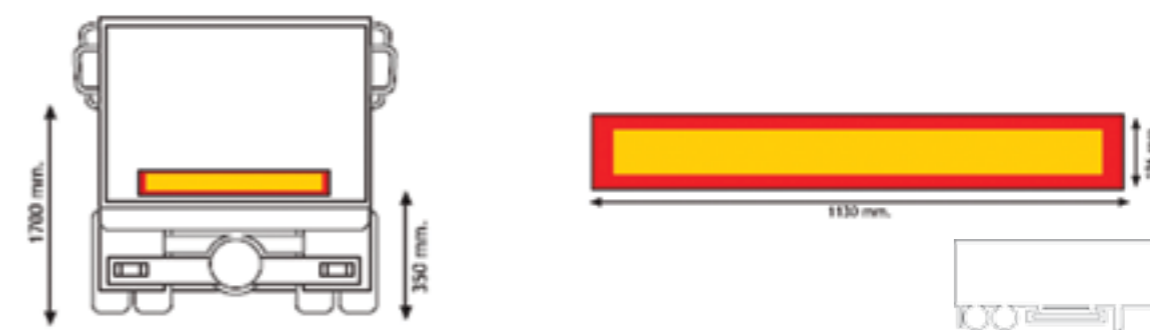

Poz.	Dimenzije (mm)	Opis	Jedinica mere	RAPIDEX broj
3.	1130 x 196	Aluminijum	KOM	OPRE0090

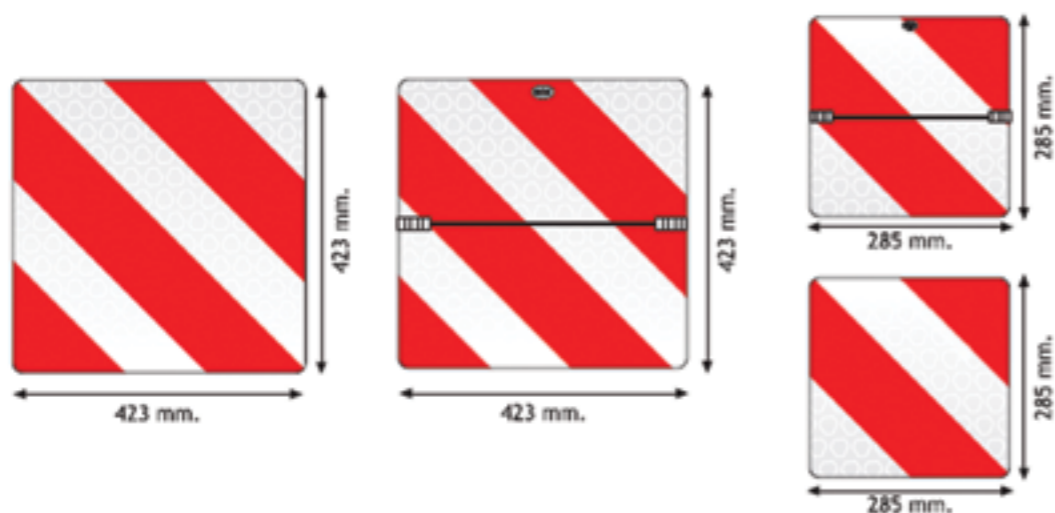
**REFLEKTUJUĆE TABLE ZA PREVOZ TERETA
VAN DOZVOLJENIH GABARITA**

Poz.	Dimenzije (mm)	Opis	Jedinica mere	RAPIDEX broj
1.	423 x 423	Aluminijum / Panel	kom	OPRE0142
2.	423 x 423	Aluminijum / Preklopiva	kom	OPRE0263
3.	285 x 285	Aluminijum / Preklopiva	kom	OPRE0265
4.	285 x 285	Aluminijum / Panel	kom	OPRE0264

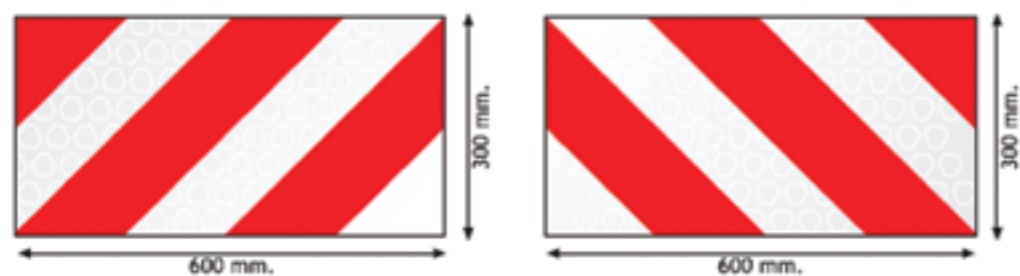

Poz.	Dimenzije (mm)	Opis	Jedinica mere	RAPIDEX broj
5.	600 x 300	Aluminijum / Panel	set	OPRE0266

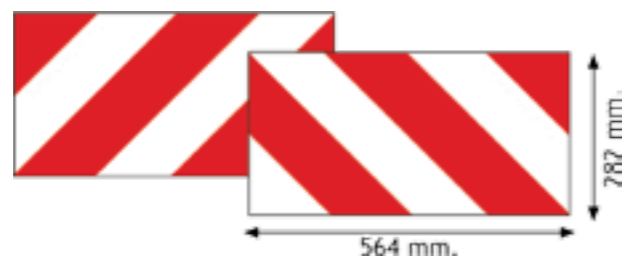

Poz.	Dimenzije (mm)	Opis	Jedinica mere	RAPIDEX broj
6.	564 x 282	Aluminijum / Panel	set	OPRE0267

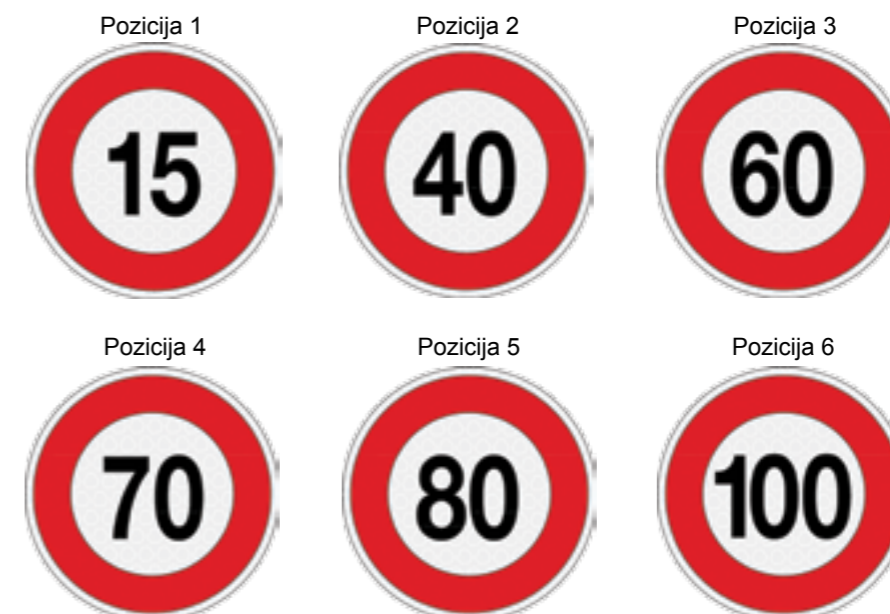
REFLEKTUJUĆE TABLE OGRANIČENJA BRZINE

Poz.	Dimenzije (mm)	Opis	RAPIDEX broj
1.	Ø 200	Nalepnica	OPRE0268
		Aluminijum	OPRE0269
2.	Ø 200	Nalepnica	OPRE0270
		Aluminijum	OPRE0271
3.	Ø 200	Nalepnica	OPRE0272
		Aluminijum	OPRE0273
4.	Ø 200	Nalepnica	OPRE0274
		Aluminijum	OPRE0275
5.	Ø 200	Nalepnica	OPRE0276
		Aluminijum	OPRE0277
6.	Ø 200	Nalepnica	OPRE0278
		Aluminijum	OPRE0279

OZNAČAVAJUĆE TABLE ZA PREVOZ DECE

Poz.	Dimenzije (mm)	Opis	RAPIDEX broj
1.	400 x 400	Aluminijum	OPRE0280
2.	400 x 400	Aluminijum / Preklopiva - Horizontalno	OPRE0089
3.	400 x 400	Nalepnica	OPRE0282

IDENTIFIKACIONE OZNAKE VOZILA

Poz.	Dimenzije (mm)	Opis	RAPIDEX broj
1.	Ø 200	Aluminijum	OPRE0283
2.	Ø 200	Aluminijum	OPRE0284
3.	Ø 200	Aluminijum	OPRE0285
4.	Ø 200	Aluminijum	OPRE0286
5.	Ø 200	Aluminijum	OPRE0055
6.	Ø 200	Aluminijum	OPRE0056
7.	Ø 200	Aluminijum	OPRE0057



Poz.	Dimenzije (mm)	Opis	RAPIDEX broj
1.	Ø 200	Aluminijum	OPRE0287
2.	Ø 200	Aluminijum	OPRE0288
3.	Ø 200	Aluminijum	OPRE0289



Poz.	Dimenzije (mm)	Opis	RAPIDEX broj
1.	400 x 250	Aluminijum	OPRE0290
2.	400 x 250	Aluminijum / Preklopiva - Horizontalno	OPRE0154
3.	400 x 250	Aluminijum / Preklopiva - Vertikalno	OPRE0291

UPOZORAVAJUĆE TABLE HIDRAULIČNIH ZADNJIH VRATA

Poz.	Opis	RAPIDEX broj
1.	Aluminijumska tabla / desna strana	OPRE0292
2.	Aluminijumska tabla / leva strana	OPRE0293
3.	Aluminijumska tabla sa nosačem / desna strana	OPRE0294
4.	Aluminijumska tabla sa nosačem / leva strana	OPRE0295
5.	Aluminijumske table sa nosačima / desna i leva strana - set	OPRE0296

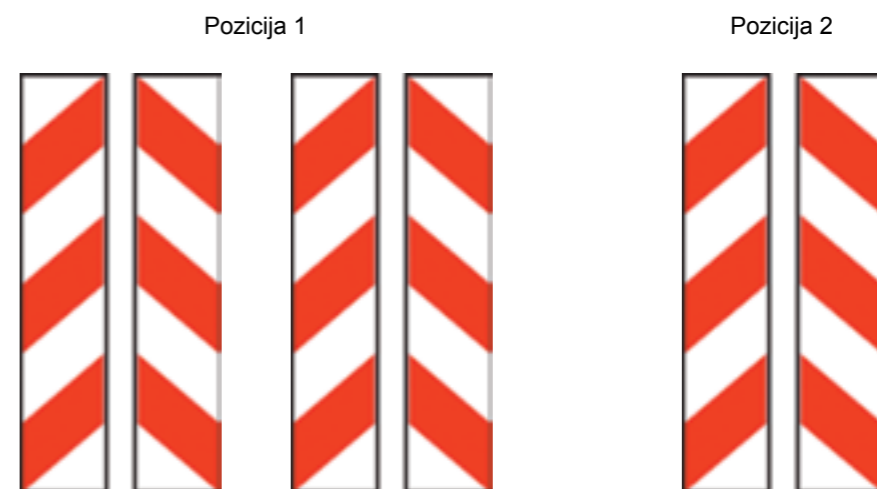
**IDENTIFIKACIONE TABLE ZA VOZILA I KONTEJNERE
SAGLASNO REGULATIVI DIN 67520**

Poz.	Dimenzije (mm)	Opis	RAPIDEX broj
1.	141 x 705	Aluminijum / SET (4 desne + 4 leve table)	OPRE0297
2.	141 x 705	Aluminijum / SET (1 desne + 1 leve table)	OPRE0298

REFLEKTUJUĆE TRAKE ZA VOZILA
SAGLASNO REGULATIVI EEC U.N.104

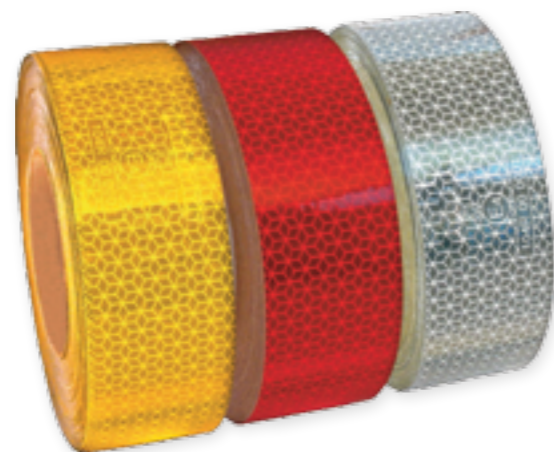

Poz.	Opis	RAPIDEX broj
1.	Reflektujuća traka žute boje 50 mm x 50 m	OPRE0299
2.	Reflektujuća traka crvene boje 50 mm x 50 m	OPRE0300
3.	Reflektujuća traka bele boje 50 mm x 50 m	OPRE0301



Poz.	Opis	RAPIDEX broj
1.	Reflektujuća traka žute boje 50 mm x 50 m	OPRE0815
2.	Reflektujuća traka crvene boje 50 mm x 50 m	OPRE0817
3.	Reflektujuća traka bele boje 50 mm x 50 m	OPRE0816

REFLEKTUJUĆE TRAKE ZA VOZILA
SAGLASNO REGULATIVI EEC U.N.104

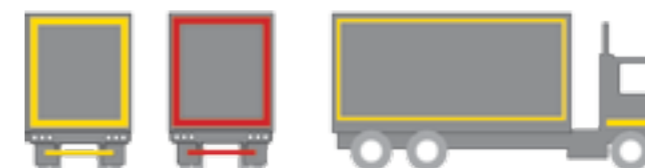
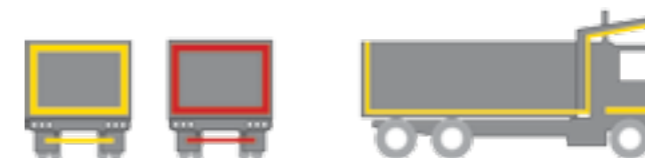
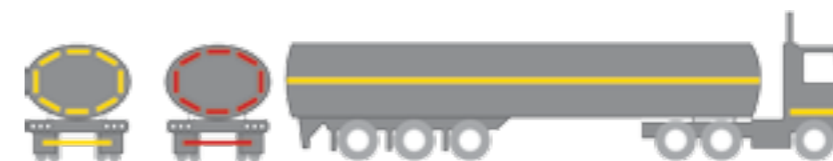

TABLE A.D.R.

Pozicija 1



Pozicija 2



Pozicija 3



Poz.	Dimenzije (mm)	Opis	RAPIDEX broj
1.	400 x 300	Aluminijum	OPRE0153
2.	400 x 300	Aluminijum / Preklopiva - Vertikalno	OPRE0152
3.	400 x 300	Aluminijum / Preklopiva - Horizontalno	OPRE0302

Pozicija 1 + 15



Pozicija 16 + 17



Pozicija 18 + 19



Poz.	Dimenzije (mm)	Opis	RAPIDEX broj
1.	400 x 300	30 - 1202 - Dizel	OPRE0035
2.	400 x 300	33 - 1203 - Benzin	OPRE0036
3.	400 x 300	30 - 1223 - Kerozin	OPRE0037
4.	400 x 300	23 - 1965 - LPG	OPRE0038
5.	400 x 300	23 - 1978 - Propan	OPRE0039
6.	400 x 300	23 - 1971 - Prirodni gas	OPRE0040
7.	400 x 300	23 - 1951 - Tečni argon	OPRE0041
8.	400 x 300	22 - 1977 - Tečni azot	OPRE0042
9.	400 x 300	22 - 2187 - Tečni CO ₂	OPRE0043
10.	400 x 300	223 - 1966 - Tečni vodonik	OPRE0044
11.	400 x 300	225 - 1073 - Tečni kiseonik	OPRE0045
12.	400 x 300	263 - 1040 - Etilenoksid	OPRE0046
13.	400 x 300	23 - 1011 - Butan	OPRE0047
14.	400 x 300	223 - 1038 - Tečni etilen	OPRE0048
15.	400 x 300	223 - 1972 - Tečni prirodni gas	OPRE0049
16.	400 x 300	30 - 1202 - Dizel / Preklopiva - Horizontalno	OPRE0052
17.	400 x 300	33 - 1203 - Benzin / Preklopiva - Horizontalno	OPRE0053
18.	400 x 300	30 - 1202 - Dizel / Preklopiva - Vertikalno	OPRE0303
19.	400 x 300	33 - 1203 - Benzin / Preklopiva - Vertikalno	OPRE0304

TABLE A.D.R.

Pozicija 1



Pozicija 2



Poz.	Dimenzije (mm)	Opis	RAPIDEX broj
1.	400 x 300	Izmenljiva tabla za dizel i benzin	OPRE0305
2.	400 x 300	Izmenljiva tabla sa ručicom za dizel i benzin	OPRE0054

Pozicija 3

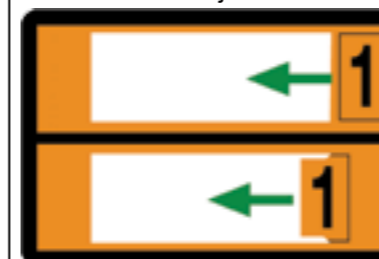

Pozicija 4 - 17



Poz.	Dimenzije (mm)	Opis	RAPIDEX broj
3.	400 x 300	Tabla(nosač) A.D.R. za različite trasporte	OPRE0034
4.	70 x 118	Set od 10 simbola za tablu A.D.R.: 0 - 2 kom.; 1 - 1 kom.; 2 - 2 kom.; 3 - 3 kom.; Prazno polje - 2 kom.	OPRE0050
5.	70 x 118	Set od 12 simbola za tablu A.D.R.: 1 - 1 kom.; 2 - 1 kom.; 3 - 2 kom.; 5 - 1 kom.; 6 - 3 kom.; 7 - 1 kom.; 8 - 1 kom.; Prazno polje - 2 komada	OPRE0051
6.	70 x 118	Set od 33 simbola za tablu A.D.R.: 0 - 3 kom.; 1 - 3 kom.; 2 - 3 kom.; 3 - 4 kom.; 4 - 2 kom.; 5 - 3 kom.; 6 - 5 kom.; 7 - 2 kom.; 8 - 3 kom.; X - 2 kom.; Prazno polje - 3 komada	OPRE0306
7.	70 x 118	Broj 1 za tablu A.D.R.	OPRE0307
8.	70 x 118	Broj 2 za tablu A.D.R.	OPRE0308
9.	70 x 118	Broj 3 za tablu A.D.R.	OPRE0309
10.	70 x 118	Broj 4 za tablu A.D.R.	OPRE0310
11.	70 x 118	Broj 5 za tablu A.D.R.	OPRE0311
12.	70 x 118	Broj 6 za tablu A.D.R.	OPRE0312
13.	70 x 118	Broj 7 za tablu A.D.R.	OPRE0313
14.	70 x 118	Broj 8 za tablu A.D.R.	OPRE0314
15.	70 x 118	Broj 0 za tablu A.D.R.	OPRE0315
16.	70 x 118	Simbol X za tablu A.D.R.	OPRE0316
17.	70 x 118	Prazno polje za tablu A.D.R.	OPRE0317

TABLE ZA OZNAČAVANJE OPASNIH MATERIJIA 300 x 300 mm

	Klasa 1.1, 1.2, 1.3 RAPIDEX broj: OPRE0318		Klasa 1.4 RAPIDEX broj: OPRE0320		Klasa 1.5 RAPIDEX broj: OPRE0319
	Klasa 1.6 RAPIDEX broj: OPRE0321		Klasa 2 RAPIDEX broj: OPRE0322		Klasa 2 RAPIDEX broj: OPRE0323
	Klasa 2 RAPIDEX broj: OPRE0324		Klasa 3 RAPIDEX broj: OPRE0340		Klasa 4.1 RAPIDEX broj: OPRE0325
	Klasa 4.2 RAPIDEX broj: OPRE0326		Klasa 4.3 RAPIDEX broj: OPRE0327		Klasa 5 RAPIDEX broj: OPRE0328
	Klasa 5.1 RAPIDEX broj: OPRE0329		Klasa 5.2 RAPIDEX broj: OPRE0330		Klasa 6.1 RAPIDEX broj: OPRE0331
	Klasa 6.2 RAPIDEX broj: OPRE0332		Klasa 7/A RAPIDEX broj: OPRE0333		Klasa 7/B RAPIDEX broj: OPRE0334
	Klasa 7/C RAPIDEX broj: OPRE0335		Klasa 7 RAPIDEX broj: OPRE0336		Klasa 8 RAPIDEX broj: OPRE0337
	Klasa 9 RAPIDEX broj: OPRE0338		Klasa 9 RAPIDEX broj: OPRE0339		

TABLE ZA OZNAČAVANJE OPASNIH MATERIJIA

KLASA	OPASNE MATERIJIE
1	Eksplozivne materije i predmeti punjeni eksplozivnim materijama
2	Zbijeni gasovi, gasovi pretvoreni u tečnost i gasovi rastvoreni pod pritiskom
3	Zapaljive tečnosti
4.1	Zapaljive čvrste materije
4.2	Materije sklone samopaljenju
4.3	Materije koje u dodiru sa vodom razvijaju zapaljive gasove
5.1	Oksidirajuće materije
5.2	Organski peroksidi
6.1	Otrovi
6.2	Gadne i zarazne materije
7	Radioaktivne materije
8	Korozivne (nagrizajuće) materije
9	Ostale opasne materije.

KUTIJA ZA PROTIVPOŽARNI APARAT



RAPIDEX broj:
OPRE0886

TEHNIČKE KARAKTERISTIKE:



Spoljašnje mere: 277 x 277 x 635 mm

Unutrašnje mere: 140 ÷ 185 mm

Kapacitet: 6 kg

Ostale karakteristike: vatrootporna, vodootporna i otporna na vibracije

PRIBORI A.D.R.

Slika	Opis	RAPIDEX broj
	Torba A.D.R. Sadrži: PVC rukavice, sredstvo za ispiranje očiju, zaštitne naočare, kompletnu masku, filter zaštitne maske i kecelju	OPRE00315
	Torba A.D.R. Sadrži: PVC rukavice, sredstvo za ispiranje očiju, zaštitne naočare, polumasku, filter zaštitne maske i kecelju	OPRE0070

PRIBORI A.D.R.

Slika	Opis	RAPIDEX broj
	Poklopac za kanalizacioni otvor 1000 x 1000 mm	OPRE0341
	Poklopac za kanalizacioni otvor 2000 x 3000 mm	OPRE0342
	Absorbujući granulat	OPRE0343
	Zaštitno odelo	OPRE0344
	Zaštitna šlem	OPRE0345
	Cipele	OPRE0346

PRIBORI A.D.R.		
Slika	Opis	RAPIDEX broj
	Reflektujući prsluk	OPRE0147
	Trougao upozorenja	OPRE0930
	Čunj	OPRE0347
	Čunj - reflektujući	OPRE0348
	Upozoravajuća lampa	OPRE0349
	Baterijska lampa	OPRE0350
	Preklapajuća lopata	OPRE0128

OPREMA		
Slika	Opis	RAPIDEX broj
	GUMENE ZAVESE 450 x 300 mm	OPRE0549
	GUMENE ZAVESE 650 x 400 mm	OPRE0548
	GUMENE ZAVESE 2400 x 400 mm	OPRE0541
	KLOCNA TOČKA metalna 160 mm	OPRE0359
	KLOCNA TOČKA metalna 200 mm	OPRE0183
	KLOCNA TOČKA plastična 160 mm	OPRE0225
	KLOCNA TOČKA plastična 200 mm	OPRE0912
	NOSAČ ZA KLOCNU 160 mm	OPRE0941
	NOSAČ ZA KLOCNU 200 mm	OPRE0947
	KUTIJA ZA ALAT 600 x 450 x 470 mm 700 x 450 x 650 mm 800 x 450 x 470 mm 1000 x 500 x 470 mm	OPRE0813 OPRE0950 OPRE0949 OPRE0948
	DIZALICA 8 t 12 t 16 t 20 t 30 t	OPRE0360 OPRE0361 OPRE0362 OPRE0208 OPRE0364
	RUDA ZA VUČU	OPRE0194
	PRIBOR ZA ČIŠĆENJE KABINE VOZAČA	OPRE0029

ZAŠTITA REZERVOARA OD KRAĐE GORIVA - KOCKON 105

RAPIDEX broj:	OPRE0814	RAPIDEX broj:	OPRE0803

ZAŠTITA REZERVOARA OD KRAĐE GORIVA - KOCKON 105 I ČEP

RAPIDEX broj:	OPRE0804	RAPIDEX broj:	OPRE0830

ČEP ZIPPER 105

RAPIDEX broj:	OPRE0808

ZAŠTITA REZERVOARA OD KRAĐE GORIVA - TERMOKING

RAPIDEX broj:	OPRE0819	RAPIDEX broj:	OPRE0820



PRIBOR ZA OSIGURAVANJE TERETA

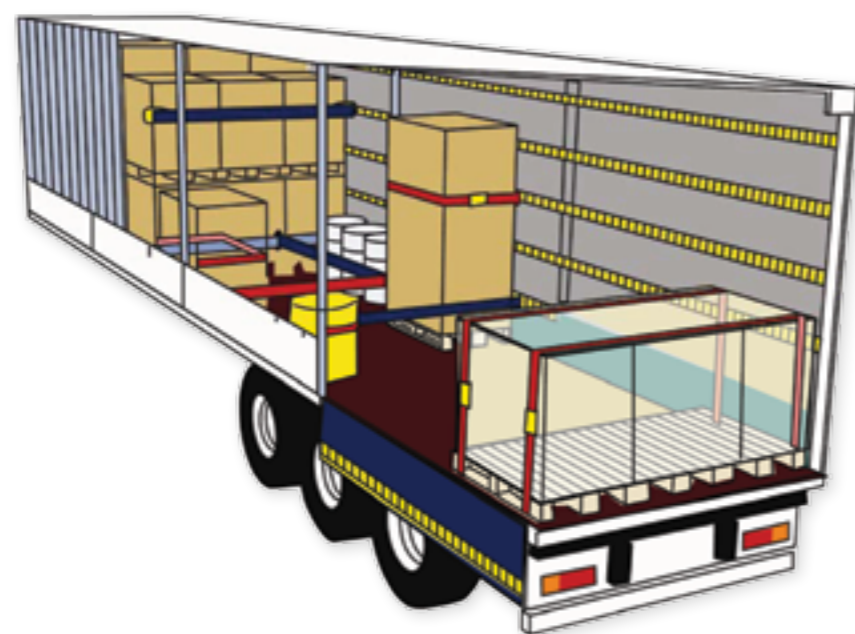
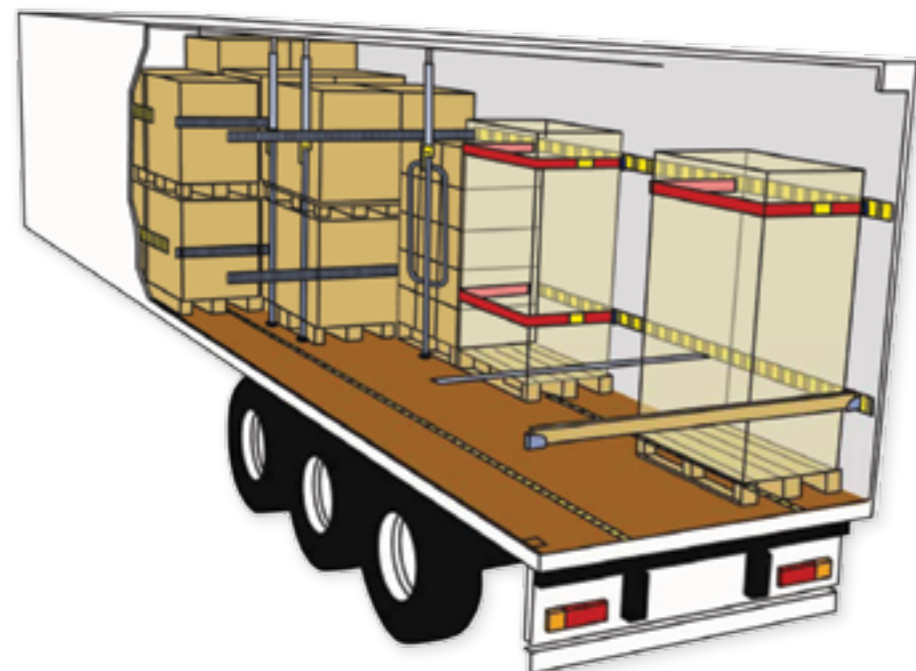

PRIBOR ZA OSIGURAVANJE TERETA



Poz.	Naziv	Dimenzije	Nosivost (daN)		RAPIDEX broj
1.	Traka za vezivanje tereta KPL	8 m x 50 mm	2500	5000	OPRE0185
2.	Traka za vezivanje tereta KPL	10 m x 50 mm	2500	5000	OPRE0184
3.	Traka za vezivanje tereta KPL	12 m x 50 mm	2500	5000	OPRE0170
4.	Traka za vezivanje tereta KPL Duga ručka	8 m x 50 mm	2500	5000	OPRE0780
5.	Traka za vezivanje tereta KPL Duga ručka	10 m x 50 mm	2500	5000	OPRE0779
6.	Traka za vezivanje tereta	10 m x 50 mm	2500	5000	OPRE001
7.	Štitnik robe	180 x 140 x 150 mm			OPRE0939



Poz.	Naziv	Dimenzije		RAPIDEX broj
1.	Letva ADR - aluminijum	21 - 36 mm	2400 - 2700 mm	OPRE0132



Poz.	Naziv	Dimenzije		RAPIDEX broj
1.	Držač - aluminijum	Ø42 mm	2100 - 2470 mm	OPRE0353
2.	Držač - aluminijum	Ø38 mm	2260 - 2630 mm	OPRE0133
3.	Držač - aluminijum	Ø42 mm	2350 - 2720 mm	OPRE0134
4.	Držač - aluminijum	Ø42 mm	2575 - 2965 mm	OPRE0700

8.4 LANCI ZA SNEG

JEDNODELNI LANCI ZA SNEG

Poz.	Primena	RAPIDEX broj
1.	295/60 R22,5	OPRE0954
2.	315/60 R22,5	OPRE0953
3.	315/70 R22,5	OPRE0952
4.	315/80 R22,5	OSTA0198

TRODELNI LANCI ZA SNEG

Poz.	Primena				RAPIDEX broj
1.	205/75 R17,5 215/75 R17,5 225/75 R17,5 235/75 R17,5 7,00 R17,5 8,00 R17,5 8,50 R17,5 9,00 R17,5	7,00 R19,5 8,00 R19,5	6,50 R20		OPRE0357
2.	8,25 R17	245/70 R19,5 265/70 R19,5 275/70 R19,5 285/70 R19,5 9,00 R19,5 9,50 R19,5	7,50 R20 8,25 R20	225/70 R22,5 8,00 R22,5 9,00 R22,5	OPRE0112
3.	305/70 R19,5	9,00 R20	275/70 R22,5 295/70 R22,5 295/60 R22,5 305/60 R22,5 10,00 R22,5	9,50 R24	OPRE0358
4.	10,00 R20 11,00 R20 12,00 R20 12,5 R20 12/80 R20 13/80 R20	11,00 R22	11,00 R22,50 12,00 R22,5 13,00 R22,5 12/80 R22,5 275/80 R22,5 295/80 R22,5 315/80 R22,5 315/75 R22,5 305/70 R22,5 315/70 R22,5 -315/60 R22,5	11.2 R24 305/75 R24,5 315/75 R24,5	OPRE0108

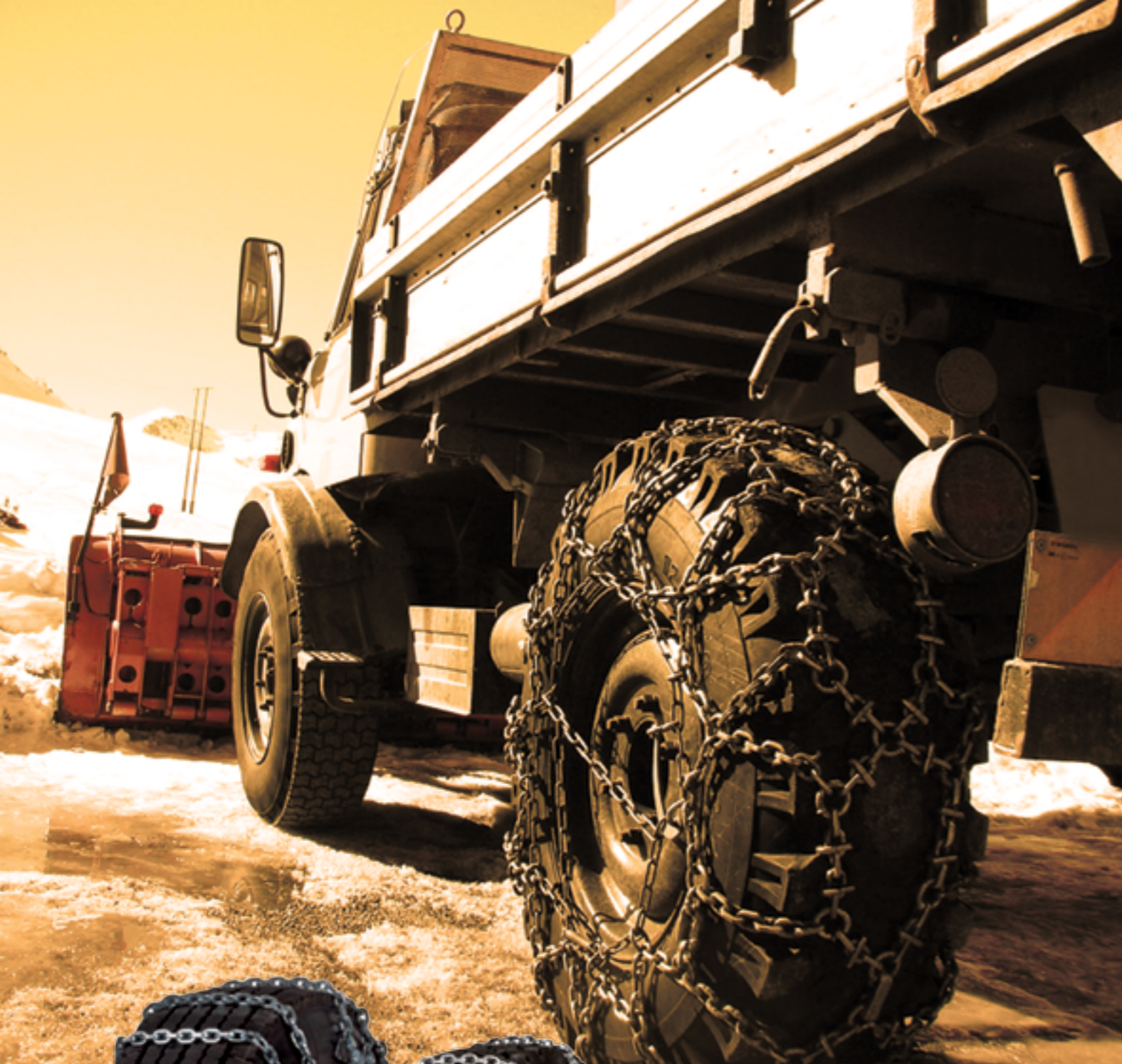

VUČNA KUKA AUTOMATSKA TIP 5055 A, DIN 74053, ISO 1102. D-50

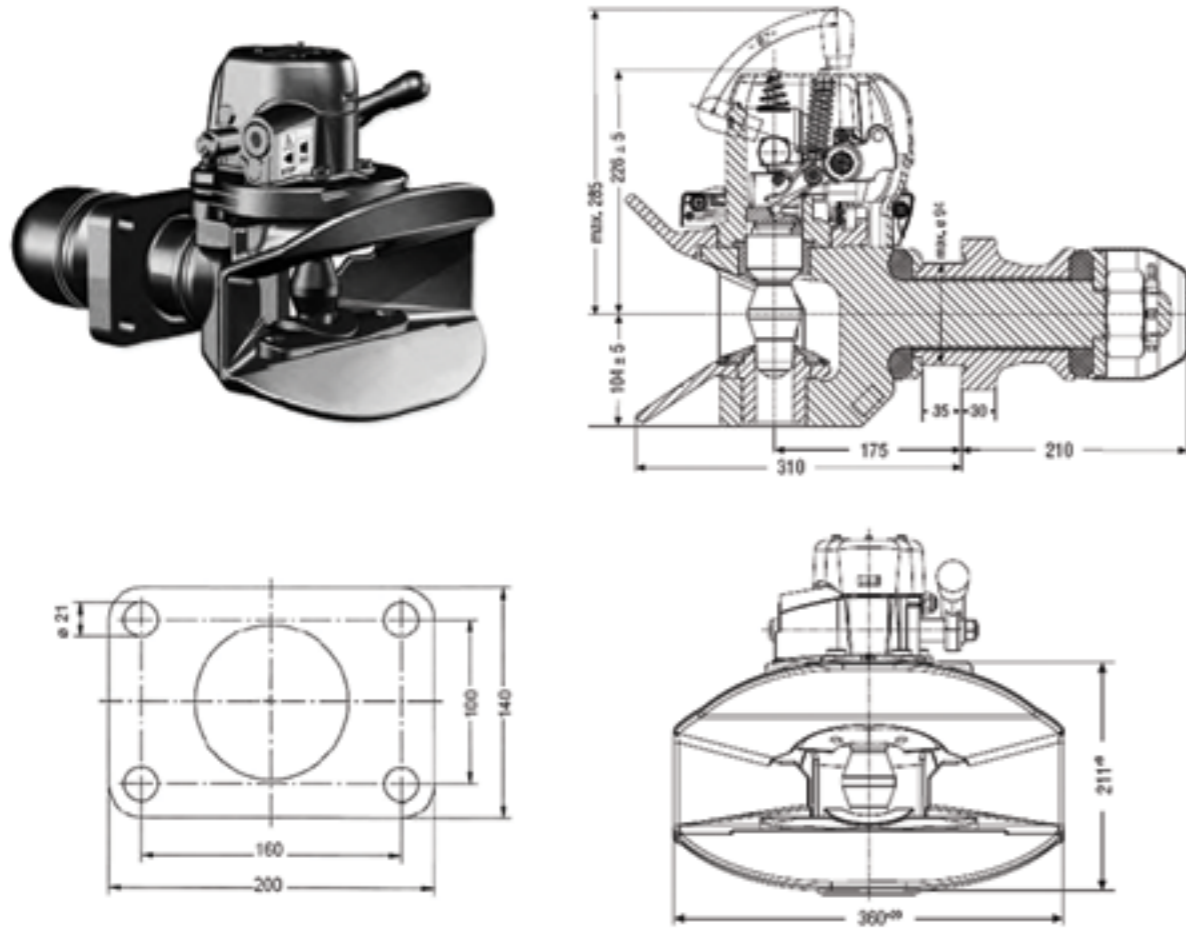

Tehničke karakteristike	Naziv	KBP	RAPIDEX broj
D = 200 kN DC = 135 kN V = 75/63 kN m = 50 kg	VUČNA KUKA	14 996 305	KARO0586
	GORNJA ČAURA	14 995 463	OPRE0237
	DONJA ČAURA	14 991 239	OPRE0236
	STOŽER	14 991 279	OPRE0238
	ZAŠTITNI LIM	14 991 255	OPRE0245

VUČNA KUKA AUTOMATSKA TIP 2045 G/145 G/150, DIN 74054, ISO 8755

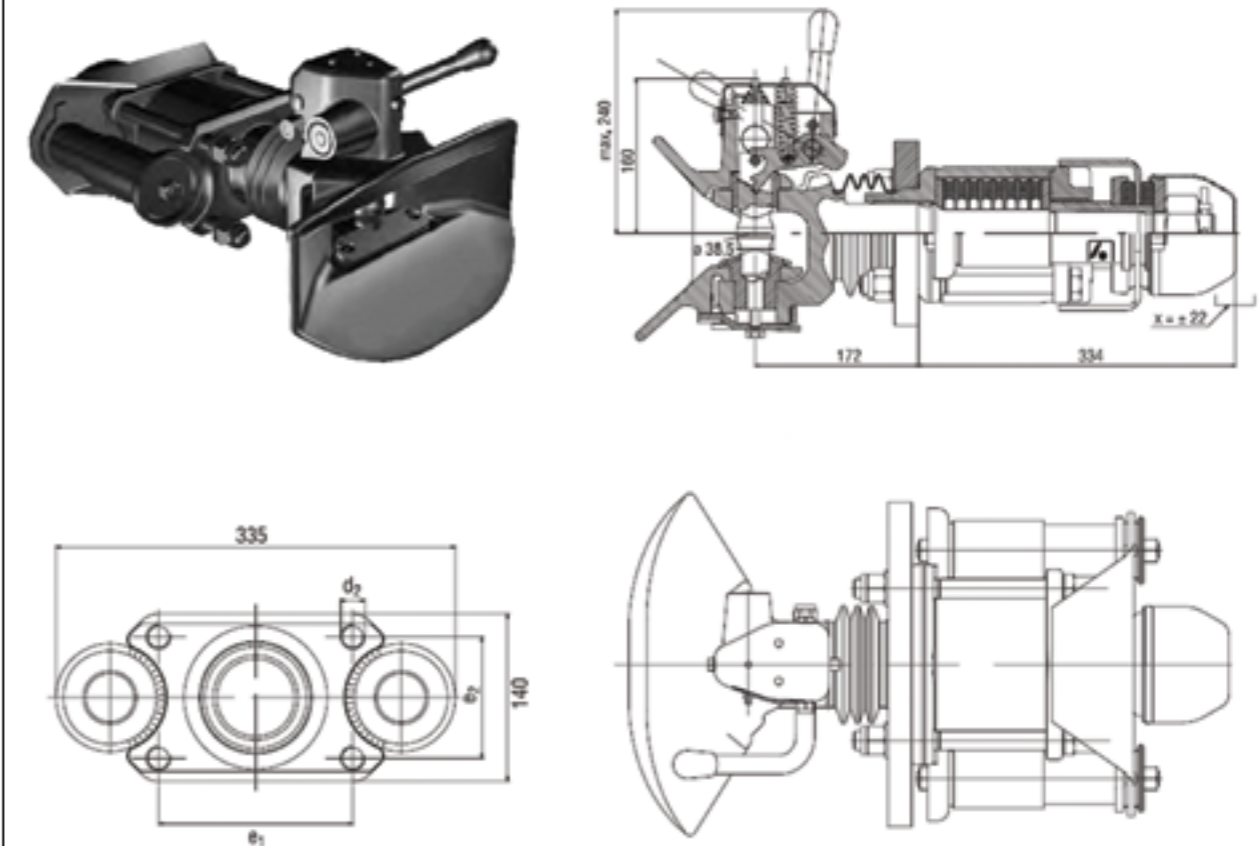

Tehničke karakteristike	Naziv	KBP	RAPIDEX broj
D = 100 kN G/145 D = 136 kN G/136 E1-G/145-140, G/150-160 E2-G/145-80, G/150-100	VUČNA KUKA	G/145 14 995 435	KARO0587
		G/150 14 995 447	KARO0651
	GORNJA ČAURA	6 997 899	OPRE0241
	DONJA ČAURA	6 997 880	OPRE0243
	STOŽER	12 991 452	OPRE0239

VUČNA KUKA AUTOMATSKA TIP 92/CX, DIN 74053, ISO 1102 D 50

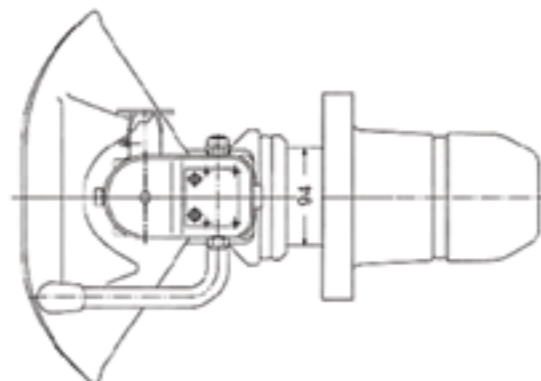
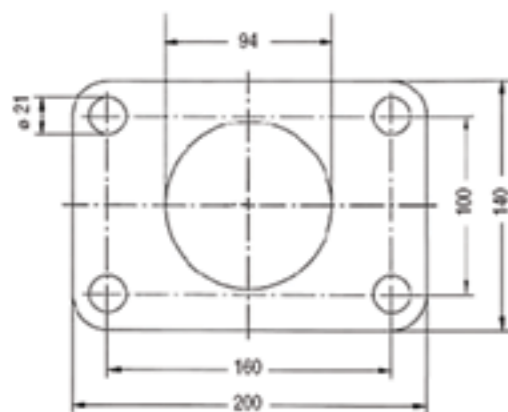
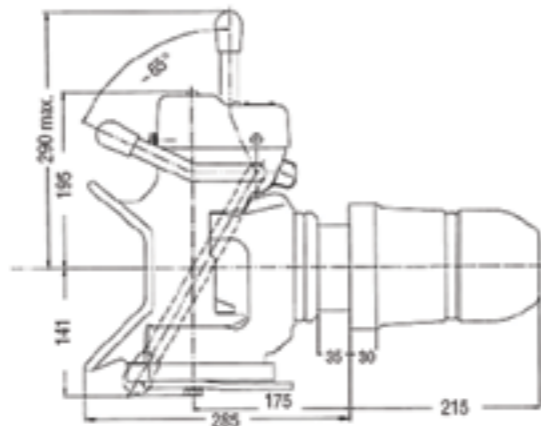

Tehničke karakteristike	Naziv	KBP	RAPIDEX broj
D = 190 kN DC = 130 kN V = 75 kN m = 50 kg	VUČNA KUKA	13 997 020	KARO0588
	GORNJA ČAURA	7 998 210	OPRE0242
	DONJA ČAURA	7 998 252	OPRE0244
	STOŽER	13 991 460	OPRE0240

AIR TOP 2000 ST



RAPIDEX broj:
HLAĐ0182

Napon (V)	Snaga (KW)	Potrošnja goriva (l/h)	Potrošnja energije (W)	Dimenzije (mm)	Težina uređaja (kg)
24	0,9 - 2,0	0,12 - 0,24	14 - 29	311 x 120 x 121	2,6

REZERVNI DELOVI - AIR TOP 2000 / 2000S / 2000ST

Poz.	Slika	Naziv / Opis	KBP	RAPIDEX broj
1.		GORIONIK AT 2000	65786A	HLAĐ0146
2.		MOTOR GREJČA AT 2000 / S	70678A	KABI0004
3.		SVEĆICA-GREJAČ AT 2000 / S	82307A	KABI0003
4.		SENZOR PLAMENA AT 2000	82306C	HLAĐ0178
5.		ZAPTIVKA AT 2000 / S / ST	1303517A	HLAĐ0751

REZERVNI DELOVI - AIR TOP 2000 / 2000S / 2000ST				
Poz.	Slika	Naziv / Opis	KBP	RAPIDEX broj
6.		PUMPA GORIVA AT 2000	65210A	ELEK0505
7.		ELEKTRONIKA AT 2000	87453B	KABI1458
8.		GORIONIK AT 2000 ST	1302799	HLAĐ0656
9.		MOTOR GREJAČA AT 2000 ST N.TIP	1302788	HLAĐ0752
10.		MOTOR GREJAČA AT 2000 ST S.TIP	1303848A	ELEK1716
11.		SVEĆICA-GREJAČ AT 2000 ST	9005087A	HLAĐ0753

AIR TOP 3500 ST					
					RAPIDEX broj: HLAĐ0861
Napon (V)	Snaga (KW)	Potrošnja goriva (l/h)	Potrošnja energije (W)	Dimenzije (mm)	Težina uređaja (kg)
24	1,5 - 3,5	0,18 - 0,42	15 - 33	428x 148 x 162	5,9

REZERVNI DELOVI - AIR TOP 3500 ST				
Poz.	Slika	Naziv / Opis	KBP	RAPIDEX broj
1.		GORIONIK AT 3500 ST	9004220A	KABI1451
2.		MOTOR GREJAČA AT 3500 ST	9005916A	HLAĐ0754
3.		SVEĆICA-GREJAČ AT 3500 ST	9004215	HLAĐ0755

AIRTRONIC D2



RAPIDEX broj:
HLAD0185

Kapacitet grejanja	W	2200	1800	1200	850
Protok toplog vazduha	kg/h	105	90	60	40
Potrošnja energije	W	34	22	12	8
Potrošnja goriva	l/h	0,28	0,23	0,15	0,1
Dimenzije uređaja	mm	310 x 115 x 122			
Težina uređaja	kg	2,7			

REZERVNI DELOVI - AIRTRONIC D2

Poz.	Slika	Naziv / Opis	KBP	RAPIDEX broj
1.		GORIONIK	252069100100	KABI1459
2.		ZAPTIVKA GORIONIKA	252069060001	KABI1465
3.		MOTOR GREJAČA	252070992000	KABI1460
4.		ZAPTIVKA MOTORA GREJAČA	252069010003	KABI1456

REZERVNI DELOVI - AIRTRONIC D2

Poz.	Slika	Naziv / Opis	KBP	RAPIDEX broj
5.		GREJAČ-SVEČICA	252070010300	KABI1464
6.		SITO SVEČICE KPL	252069100102	KABI1452
7.		SITO SVEČICE	252069100102	KABI1467
8.		PUMPA GORIVA	224518010000	KABI1461

AIRTRONIC D4



RAPIDEX broj:
HLAD0186

Kapacitet grejanja	W	4000	3000	2000	900
Protok toplog vazduha	kg/h	185	140	100	55
Potrošnja energije	W	55	30	16	7
Potrošnja goriva	l/h	0,51	0,38	0,25	0,11
Dimenzije uređaja	mm	376 x 140 x 150			
Težina uređaja	kg	4,5			

REZERVNI DELOVI - AIRTRONIC D4				
Poz.	Slika	Naziv / Opis	KBP	RAPIDEX broj
1.		GORIONIK	252113100100	KABI1462
2.		MOTOR GREJAČA	252114992000	KABI1450
3.		ZAPTIVKA MOTORA GREJAČA	252113010003	KABI1463
4.		GREJAČ-SVEĆICA	252070010300	KABI1464
5.		SITO SVEĆICE KPL	252069100102	KABI1452
6.		SITO SVEĆICE	252069100102	KABI1467
7.		PUMPA GORIVA	224518010000	KABI1461

Komercijalna Vozila



Uvod

Zaštita vašeg motora i ušteda goriva je uvek bila važna uloga Q8 motornih ulja. Zahvaljujući inovacijama, emisija od 25 kamiona danas je jednaka 1 kamionu od pre 30 godina. Da bi se produžio vek ovih motora i vek sistema za prečišćavanje izduvnih gasova, razvili smo novu liniju Q8 Oils maziva za teške dizel motore.

Trendovi

U skladu sa strogim propisima EU o emisiji gasova, svaki moderno dizajnirani kamion sadrži komponente kao što su katalizator, EGR i filtere protiv čađi. Kompanija Q8 Oils razvila je liniju maziva koja ovim komponentama dugoročno obezbeđuje da budu čisti. Time se ujedno smanjuju troškovi održavanja kao i veliki troškovi zamene zagađenih delova; na primer, naknadna ugradnja SCR sistema u proseku košta 7.000,00 EUR.

Naša tehnologija koja je ugrađena u proizvodima Q8 T 904, Q8 T 905, Q8 T 910 i Q8 T 760 obezbeđuje smanjenje vaših troškova održavanja.

Maziva koja obezbeđuju smanjenu potrošnju goriva postala su još privlačnija zato što u najnovijim EURO VI motorima za sve vrste kamiona odobreno je korišćenje ulja sa niskim nivoom gustine, što ujedno predstavlja i za vas priliku da sačuvate novac i garanciju. Maziva koja preporučujemo za smanjenu potrošnju goriva su sledeća: Q8 T 910 5W-30, Q8 T 904 FE 10W-30, Q8 T 760 10W-30 and Q8 SuperTruck FE 5W-30.



Motorna ulja za transportna vozila

Za dugi servisni interval potrebna su ulja visokog kvaliteta, kao što su Q8 T 904 FE ili Q8 T 910.

Rešenje koje pruža kompanija Q8 Oils

U niže navedenoj tabeli prikazani su proizvodi Q8 motorna ulja koja se preporučuju prema vrsti kamiona. SAPS kateorija (Sulphated Ash Phosphorous Sulphur) namenjena za sisteme pročišćavanja izduvnih gasova je specificirana od strane proizvođača kamiona. Izborom Q8 maziva, možete da preferirate između uštede ulja ili periode zamene ulja.

			Ekonomična potrošnja	Osobine pri paljenju hladnog motor	Period zamene ulja						
					DAF	MAN	Mercedes	Volvo	Renault	Iveco	Scania
NISKA VREDNOST PEPELA	Q8 T 904	10W-40	**	**	Long Drain	Long Drain	Long Drain	Medium Drain	Medium Drain	Long Drain (*)	-
	Q8 T 905	10W-40	**	***	Long Drain	Long Drain	Long Drain	Medium Drain	Medium Drain	Long Drain (*)	Medium Drain (**)
	Q8 T 904 FE	10W-30	***	***	Long Drain	Long Drain	Long Drain	Medium Drain	Medium Drain	Long Drain (*)	-
	Q8 T 910	5W-30	****	****	Long Drain	Long Drain	Long Drain	Medium Drain	Medium Drain	Long Drain (*)	-
SREDNJA VREDNOST PEPELA	Q8 T 760	15W-40	*	**	Medium Drain	Medium Drain	Medium Drain	Long Drain	Long Drain	-	Short Drain (***)
	Q8 T 760	10W-30	***	***	Medium Drain	Medium Drain	Medium Drain	Long Drain	Long Drain	-	Short Drain (***)
VISOKA VREDNOST PEPELA	Q8 T 860 S	10W-40	**	***	Long Drain	Long Drain	Long Drain	Long Drain	Long Drain	Long Drain	Long Drain (***)
	Q8 Super Truck FE	5W-30	****	****	Long Drain	Long Drain	Long Drain	Long Drain	Long Drain	Long Drain	Long Drain

(*) od Iveco generacije EURO VI
 (**) EURO VI Scania motori
 (***) Scania motori sa DPF filterom

NISKA VREDNOST PEPELA	Q8 T 910	5W-30	FUEL saver	Dizajnirano za uštedu goriva, mazivo niskog viskoziteta sa odličnim osobinama pri paljenju hladnih motora za skoro sve vrste Euro IV, V i VI dizel motora. Ovo sintetičko ulje sa odličnim performansama i SAPS tehnologijom niske vrednosti razvijeno je specijalno za komercijalna vozila sa dizel filterom za čišćenje čestica (DPF).
	Specifikacije:	ACEA E6/E7; API CI-4		
	Odobrenja:	MAN 3477; MB 228.51; VOLVO VDS-3; RENAULT RLD-2; MACK EO-N		
Q8 Oils preporuke:		DEUTZ DQC IV-10 LA; MACK EO-M PLUS; MTU TYP-3.1; RENAULT VI RGD/RXD; VOLVO CNG		
NISKA VREDNOST PEPELA	Q8 T 905	10W-40		Sintetičko motorno ulje visokih performansi za teške uslove rada sa niskom vrednošću SAPS-a. Dizajniran je za podmazivanje velikog broja Euro IV, V i VI dizel motora opremljenih sa filterom za čišćenje čestica (DPF) ili katalizatorom (kao SCR) i radi na dizel gorivu sa malo sumpora i pod teškim uslovima. Takođe odgovara i Euro III motorima. Q8 T 905 ima odlična svojstva pri paljenju hladnih motora.
	Specifikacije:	ACEA E6/E7/E9; API CI-4;		
	Odobrenja:	DEUTZ DQC III-10 LA; MACK EO-N; MAN 3477; MB 228.51; MTU TYP-3; RENAULT VI RLD-2; SCANIA Low Ash; VOLVO VDS-3		
Q8 Oils preporuke:		CUMMINS CES 20076/77; DAF; MACK EO-M PLUS; MB 226.9; MTU TYP 3.1; RENAULT VI RGD, RXD; VOLVO CNG; MAN 3271-1; CATERPILLAR ECF-1a		
NISKA VREDNOST PEPELA	Q8 T 904 FE	10W-30	FUEL saver	Dizajniran za štednju goriva, mazivo niskog viskoziteta za skoro sve Euro IV, V i VI dizel motore. Sintetičko motorno ulje visokih performansi za teške uslove rada sa niskom vrednošću SAPS-a.
	Specifikacije:	ACEA E6,E7; API CI-4		
	Odobrenja:	MAN M3477; MB 228.51; VOLVO VDS-3; RENAULT VI RLD-2; MACK EO-N		
Q8 Oils preporuke:		DAF; CUMMINS CES 20076/77; DEUTZ DQC III-10 LA		
NISKA VREDNOST PEPELA	Q8 T 904	10W-40		Sintetičko motorno ulje visokih performansi za teške uslove rada sa niskom vrednošću SAPS-a dizajniran je za podmazivanje skoro svih Euro IV, V i VI dizel motora.
	Specifikacije:	ACEA E6 /E7; API CI-4		
	Odobrenja:	MAN M3477; MB 228.51; MTU Type 3.1; RENAULT VI RLD-2; VOLVO VDS-3; MACK EO-N; DEUTZ DQC III-10 LA		
Q8 Oils preporuke:		DAF; CUMMINS CES 20076/77		
SREDNJA VREDNOST PEPELA	Q8 T 760	15W-40 10W-30	FUEL saver	SHPD (Super High Performance Diesel) dizel motorno ulje sa niskom vrednošću sulfatnog pepela i ograničenom vrednošću fosfora i sumpora, namenjeno za motore koji su u skladu sa Euro V standardom i Američkim EPA 2007 zahtevima za izduvne gasove. Pogodno je za duge intervale zamene ulja i za vozila opremljena sa filterima za čišćenje čestica i katalizatorima (npr. SCR). Q8 T 760 SAE 15W-40 takođe može da se koristi i za Euro II i III dizel motore. Q8 T 760 SAE 10W-30 je ulje koje šteti gorivo, niskog viskoziteta i nije pogodan za starije motore.
	Specifikacije:	ACEA E9; API CJ-4/API SN; CATERPILLAR ECF-1a/ECF-2/ECF-3		
	Odobrenja:	MACK EO-O PREMIUM PLUS; MAN 3575; MB228.31; RENAULT VI RLD-3; VOLVO VDS-4		
Q8 Oils preporuke:		CUMMINS CES 20081; DDC 93K218; DEUTZ DQC III-10; MAN 3275; MTU TYPE 2.1		
VISOKA VREDNOST PEPELA	Q8 T 860 S	10W-40		Dizel motorno ulje sa izuzetno visokim performansama koje se sastoji od sintetičkih baznih ulja. Razvijeno je motore kompanije Scania koja dozvoljava zamenu ulja na 120.000 km. Na tržištu je dostupno od marta 2013.
	Specifikacije:	ACEA E4/E7; API CF		
	Odobrenja:	SCANIA LDF-3		
Q8 Oils preporuke:		VOLVO VDS-3; MB 228.5; MAN 3277; RENAULT RLD-2		
VISOKA VREDNOST PEPELA	Q8 SuperTruck FE	5W-30	FUEL saver	Dizajnirano za uštedu goriva, mazivo niskog viskoziteta sa odličnim osobinama pri paljenju hladnih motora za skoro sve vrste Euro III i neke vrste Euro IV i V dizel motora. Ovo je UHPD (Ultra High Performance Diesel) sintetičko dizel motorno ulje sa izuzetno visokim performansama koje omogućava produženi interval zamene ulja.
	Specifikacije:	ACEA E4/E7		
	Odobrenja:	MAN 3277; MB 228.5;		
Q8 Oils preporuke:		IVECO; CUMMINS CES 20071/72/76/77; MACK EO-M PLUS; MB 235.28; MTU TYPE-3; SCANIA LDF; VOLVO VDS-3		

VISOKA VREDNOST PEPELA	Q8 T 860	10W-40	UHPD dizel motorno ulje sa izuzetno visokim performansama na sintetičkoj bazi namenjeno je za skoro sve Euro III i pojedine Euro IV i V dizel motore. ACEA E4 specifikacija garantuje visok nivo čišćenja čadi u motoru.
	Specifikacije:	ACEA E4/E7; API CI-4	
	Odobrenja:	CUMMINS CES 20077/78; DEUTZ DQC III-05; MACK EO-M PLUS; MAN 3277; MB 228.5; MTU TYPE-3; SCANIA LDF-2; TEDOM 258-3; VOLVO VDS-3	
	Q8 Oils preporuke:	DAF; JASO DH-1; RENAULT VI RXD/RLD-2; VOITH RETARDER KLASSE A	
VISOKA VREDNOST PEPELA	Q8 T 800	10W-40	Polu-sintetičko dizel motorno ulje visokih performansi namenjeno je za Euro III i Euro IV motore sa niskom emisijom izduvnih gasova, koje omogućava i smanjenje potrošnje goriva. Takođe je pogodno za dizel motore putničkih automobila i manje motore sa direktnim ubrizgavanjem.
	Specifikacije:	ACEA E7/B4/A3; API CI-4/SL	
	Odobrenja:	MACK EO-N; MAN 3275; RENAULT VI RLD-2; TEDOM 258-3; VOLVO VDS-3, DEUTZ DQC III -10; MTU TYP-2	
	Q8 Oils preporuke:	CUMMINS CES 20071/72/76/77/78; MACK EO-M PLUS; MB 228.3; MB 229.1; GLOBAL DHD-1; CATERPILLAR ECF-1/ECF-2	
VISOKA VREDNOST PEPELA	Q8 T 750	15W-40	Q8 T 750 može da se koristi za sve četvorotaktne dizel motore sa gorivom koje ima malu vrednost sumora (<0.05 %) i za motore kamiona, kao i za motore poljoprivrednih i industrijskih radilica koje rade pod teškim uslovima. Takođe može da se koristi kod benzinskih i dizel motora putničkih automobila.
	Specifikacije:	ACEA E7/B4/A3; API CI-4/SL;	
	Odobrenja:	DEUTZ III-10; MACK EO-N PLUS; MAN 3275; VOLVO VDS-3; MB 228.3; MTU TYPE-2; RENAULT VI RLD, RLD-2; ZF TE-ML 04C/07C; CUMMINS 20071/72/76/77	
	Q8 Oils preporuke:	MB 229.1; GLOBAL DHD-1; CATERPILLAR ECF-1/ECF-2	



Ulja za menjače i osovine kod komercijalnih vozila

Kod savremenih menjača i osovina, od suštinskog značaja su dobra zaštita od trenja i termička stabilnost, da bi se postigao što duži servisni interval. Ulja za menjače imaju i veliki uticaj na potrošnju goriva. Kao na primer Q8 T 60Ntech u menjaču i Q8 T 66 u zadnjoj osovini.

	GL-4	GL-5	mil-prf 2104e	Synth. Base Oil Components	Long Drain	Fuel Economy	Drive Line = Gear Box + Rear Axle	Intarder Suited	DAF	Iveco	MAN	Mercedes	Renault	Scania	Volvo
MENJAC	Q8 Gear Oil XG	✓	✓	-	*	*	✓	-	-	-	✓	-	-	✓	-
	Q8 T60Ntech	-	-	-	**	**	-	✓	✓	✓	✓	-	✓	-	-
	Q8 Supergear S	GL-3	-	-	***	**	**	-	-	-	-	-	-	-	✓
	Q8 T 36	✓	-	-	***	***	*	-	-	-	-	✓	-	-	-
ZADNJA OSOVINA	Q8 Axle Oil XG	✓	✓	✓	-	*	*	✓	-	✓	-	-	-	✓	-
	Q8 Trans XGS	✓	✓	✓	***	***	**	✓	✓	✓	✓	✓	-	-	-
	Q8 T 65	-	✓	-	***	***	**	-	-	-	-	-	-	-	✓
	Q8 Unigear GL-5	-	✓	-	***	**	**	-	-	-	-	-	-	-	✓
	Q8 T 66	✓	✓	✓	***	***	***	-	✓	✓	✓	✓	-	✓	✓

MENJAC	Q8 Gear Oil XG	80W-90	Q8 Gear Oil XG je automotivno univerzalno menjačko ulje za sinhronizovane i nesinhronizovane manuelne menjače, osovine i sve komponente koje prenose snagu (od motora do zadnje osovine) i koje zahtevaju API GL-4/GL-5 nivo performansi. Odobreno je od strane kompanije Scania za servisni interval do 180.000 km.
	Specifikacije: Odobrenja:	API GL-4; API GL-5 SCANIA STO 1:0; SAE J 2360 (PRI GL 0208); MAN 341 E2/Z2, 342 M2; ZF TE-ML 02B/05A/12E	
MENJAC	Q8 T 60 Ntech	75W-80	Q8 T 60 Ntech je ulje na sintetičkoj bazi za manuelne menjače sa visokim performansama koji zahtevaju specijalne osobine tečnosti na niskim i visokim temperaturama, što rezultuje da se lakše menjaju brzine.
	Odobrenja: Q8 Oils preporuke:	ZF TE ML 02L MAN 341 Z3/E3/Z4; VOLVO 97305; ZF TE-ML 01L	
MENJAC	Q8 SuperGear S	75W-80	Q8 SuperGear S je sintetičko ulje sa najnovijom tehnologijom aditiva za manuelne menjače. Može se koristiti kao višenamensko ulje za manuelne menjače kod kamiona, autobusa i putničkih automobila.
	Specifikacije: Q8 Oils preporuke:	API GL-3; VOLVO 97305 JOHN DEERE JDM J11C; VOLVO 97307	
MENJAC	Q8 SuperGear V	75W-80	Q8 SuperGear V je sintetičko ulje razvijeno za Volvo manuelne menjače. Može se koristiti kao ulje za manuelne menjače u kamionima i autobusima.
	Specifikacije: Odobrenja: Q8 Oils preporuke:	API GL-4 VOLVO 97307 MAN 341 ZE-VR (former MAN 341 SL); VOITH RETARDER OIL CLASS C; EATON S SERIES TRANSMISSIONS	
MENJAC	Q8 T 36	75W-90	Q8 T 36 je potpuno sintetičko ulje za "switch gear" menjače sa najvišim performansama koji zahtevaju posebna svojstva tečnosti na visokim i niskim temperaturama i time poboljšavaju prenose. Proizvod je razvijen specijano za komercijalna vozila marke Mercedes.
	Specifikacije: Odobrenja:	API GL-4 MAN 342 TYP MB; MB 235.11	
ZADNJA OSOVINA	Q8 Axle Oil XG	80W-140	Automotivno ulje koje je namenjeno za osovine i diferencijale. Odobreno je od strane kompanije Scania za servisni interval do 180.000 km.
	Specifikacije: Odobrenja: Q8 Oils preporuke:	API GL-4/GL-5; MIL-PRF-2105 E SCANIA STO 1:0; ZF TE-ML 05A/12E/16D/21A ZF TE-ML 02B	
ZADNJA OSOVINA	Q8 Trans XGS	75W-90	Sintetičko automotivno ulje za zadnje osovine, diferencijale i pojedine manuelne menjače koji rade pod teškim uslovima i koji zahtevaju posebne osobine tečnosti pri niskim temperaturama da bi se dobila niža potrošnja goriva i lakša promena brzina.
	Specifikacije: Odobrenja: Q8 Oils preporuke:	API GL-4/GL-5; MIL-PRF-2105-E MAN 341 E3/Z2, 342 M3; SCANIA STO 1:0; ZF TE-ML 02B/5A/12B MAN 342 S1	
ZADNJA OSOVINA	Q8 T 65	75W-90	Sintetičko ulje za menjače koje pruža kombinaciju dobrih osobina tečnosti na niskim i visokim temperaturama. Time se smanjuje trenje i samim tim smanjuje se i buka prenosa i potrošnja goriva.
	Specifikacije: Odobrenja: Q8 Oils preporuke:	API GL-5 VOLVO 97312; ZF TE-ML 17B/19B ZF TE-ML 05A	
ZADNJA OSOVINA	Q8 Unigear GL-5	75W-90	Automotivno ulje na sintetičkoj bazi namenjeno je za manuelne menjače i osovine u putničkim i komercijalnim vozilima.
	Specifikacije: Q8 Oils preporuke:	API GL-5; MIL-L-2105D ZF TE-ML 05A	
ZADNJA OSOVINA	Q8 T 66	75W-110	Razvijen u cilju postizanja značajne uštede goriva za osovine u kamionima koji rade pod velikim opterećenjem. Relativno novi viskozitet SAE 110 se koristi radi postizanja optimalnog podmazivanja. Ovo sintetičko ulje je za podmazivanje visoko opterećenih komponentata, kao što su zadnje osovine, diferencijali i pojedini menjači. Potvrđeno je da Q8 T 66 smanjuje potrošnju goriva do 4,7 %.
	Specifikacije: Q8 Oils preporuke:	API GL-4/GL-5; API MT-1; MIL-PRF-2105E; SAE J 2360 ZF TE-ML-05B/12B; MACK GO-J; MB 235.8; MAN 341 S1; SCANIA STO 1:0	



Ulja za automatske menjače u komercijalnim vozilima



Q8 Auto 14	Ulje za automatske menjače koje takođe odgovara za servo volane i kao hidraulično ulje.
Q8 Oils preporuke:	MB 236.7; VME; ZF TE-ML 14A; VOITH 55.6335.3X
Q8 Auto 15 ED	Q8 Auto 15 ED je ulje na sintetičkoj bazi za automatske menjače koje takođe odgovara za servo volane i kao hidraulično ulje.
Q8 Oils preporuke:	VOITH DIWA H55.6336.3X; ZF TE-ML 14B

Hidraulična ulja za komercijalna vozila



Q8 Haydn	10, 15, 22, 32, 46, 68, 100, 150	Univerzalno hidraulično ulje za višenamensku upotrebu sa indeksom viskoziteta vrednosti 100. Bazno ulje ima dobar prirodni otpor starenju (oskidaciji) i ujedno veoma svetlu boju. Ovo se lako filtrira.
Važeći za sledeće primene:		AFNOR 48-603, CATEGORY HM; MAG IAS P-68/P-69/P-70; DENISON HF-0/HF-1/HF-2; DIN 51524 PART 2, CATEGORY HLP; ISO 11158, CATEGORY HM; SS 155434, CATEGORY AM
Q8 Heller	15, 22, 32, 46, 68, 100	Q8 Heller je mineralno hidraulično ulje tipa HVLP sa izuzetno visokim indeksom viskoziteta, vrednosti 150. Q8 Heller je idealno za upotrebu u hidrauličnim sistemima koje rade u uslovima velikih temperaturnih promena. Optimalni viskozitet pri pokretanju u hladnim uslovima obezbeđuje neometani rad hidrauličnih sistema. Koristi se za kopačice i ostale mašine koje rade u spoljnim uslovima. Q8 Heller odgovara zahtevima većine proizvođača džipova.
Važeći za sledeće primene:		AFNOR 48-603, CATEGORY HV; DIN 51524 PART 3, CATEGORY HVLP; ISO 11158, CATEGORY HV

Masti za komercijalna vozila



Q8 Rembrandt EP 2	NLGI 2	Višenamenska litijumska mast unapređena sa aditivima koji poboljšavaju osobine otpornosti pri visokom pritisku i oksidaciji; takođe sadrži i inhibitor rđanja.
Veličina pakovanja:		50kg KEG, 12.5kg, 180kg, 12 x 400g (CART)
Q8 Rembrandt Moly	NLGI 2	Visoko kvalitetna višenamenska litijumska mast koja sadrži molibdenski disulfid koji obezbeđuje dodatnu zaštitu od trenja. Sadrži inhibitor rđanja i additive protiv oksidiranja.
Veličina pakovanja:		50kg KEG, 12.5kg, 180kg, 12 x 400g (CART)
Q8 Rembrandt EP 00 WV	NLGI 00	Litijumska mast za centralne sisteme podmazivanja marke Willy Vogel preporučuje se za upotrebu kada se zahtevaju specifikacije MB 264 i MAN 283. Specijalno za automotivne aplikacije gde je potrebno lako pumapanje pri niskim temperaturama.
Veličina pakovanja:		12.5kg, 50kg KEG, 12.5kg
Q8 Rubens WB Blau	NLGI 2	Višenamenska litijumska kompleksna mast za ležajeve u kamionima i prikolicama gde je potrebno lako pumapanje u centralnim sistemima za podmazivanje a zahteva se NLGI 2 mast.
Veličina pakovanja:		50kg KEG, 12.5kg, 12 x 400g (CART)

Ostali proizvodi



Q8 Brake Fluid DOT 4		Nepetrolejska kočiona tečnost sa osobinom stvaranja niskog parnog pritiska. Pogodna je za korišćenje u hidrauličnim sistemima kočnica i kvačila u svim putničkim automobilima, kamionima, autobusima i prikolicama gde se traže proizvodi visokih performansi. Ovaj proizvod se posebno preporučuje za funkcionisanje pri visokim temperaturama koje se stvara od kočionih diskova ili kada postoji dodatno opterećenje na kočionom sistemu.
Q8 Oils preporuke:		FMVSS 116 DOT 3; FMVSS 116 DOT 4; SAE J1703
Veličina pakovanja:		50kg KEG, 12.5kg, 180kg, 12 x 400g (CART)
Q8 Antifreeze Long Life		Univerzalni koncentrat antifrizna visokih performansi koji daje zaštitu tokom cele godine kao rashladna tečnost leti i antifriz zimi. Baziran je na etilen glikolu, hemijski stabilan i ne podleže koroziji.
Q8 Oils preporuke:		BS 6580, 5177; SAE J 1034; ASTM D 3306; FVV Heft R 443; MAN 324 TYPE SNF
Veličina pakovanja:		1L, 5L, 25L, 205L
Q8 Degreasing Fluid HFB		Višenamenski odmašivač koji se ispira vodom.
Veličina pakovanja:		25L, 208L

Q8 Oils

MOTORNO ULJE	Q8 T 905	208 litara	RAPIDEX BROJ - ULJA0171
	Q8 T 905	60 litara	RAPIDEX BROJ - ULJA0129
	Q8 T 905	20 litara	RAPIDEX BROJ - ULJA0130

MOTORNO ULJE	Q8 T 860	208 litara	RAPIDEX BROJ - ULJA0135
	Q8 T 860	60 litara	RAPIDEX BROJ - ULJA0128
	Q8 T 860	20 litara	RAPIDEX BROJ - ULJA0127
	Q8 T 860	5 litara	RAPIDEX BROJ - ULJA0157

MOTORNO ULJE	Q8 T 800	1000 litara	RAPIDEX BROJ - ULJA0185
	Q8 T 800	208 litara	RAPIDEX BROJ - ULJA0158
	Q8 T 800	60 litara	RAPIDEX BROJ - ULJA0193
	Q8 T 800	20 litara	RAPIDEX BROJ - ULJA0159
	Q8 T 800	5 litara	RAPIDEX BROJ - ULJA0160

MOTORNO ULJE	Q8 T 760	208 litara	RAPIDEX BROJ - ULJA0171
	Q8 T 760	20 litara	RAPIDEX BROJ - ULJA0129
	-	-	-

MOTORNO ULJE	Q8 T 750	208 litara	RAPIDEX BROJ - ULJA0136
	Q8 T 750	60 litara	RAPIDEX BROJ - ULJA0146
	Q8 T 750	20 litara	RAPIDEX BROJ - ULJA0145
	Q8 T 750	5 litara	RAPIDEX BROJ - ULJA0194

MOTORNO ULJE	Q8 T 520	208 litara	RAPIDEX BROJ - ULJA0161
	Q8 T 520	20 litara	RAPIDEX BROJ - ULJA0162
	-	-	-

ANTIFRIZ	G12 + KONCENTRAT	208 litara	RAPIDEX BROJ - HLA00648
	G12 + KONCENTRAT	20 litara	RAPIDEX BROJ - HLA00647
	-	-	-

MAST	Q8 REMBRANT EP2	192 kilograma	RAPIDEX BROJ - ULJA0246
	Q8 REMBRANT EP2	18 kilograma	RAPIDEX BROJ - ULJA0203
	Q8 REMBRANT EP2	5 kilograma	RAPIDEX BROJ - ULJA0183
	Q8 REMBRANT EP2	0,4 kilograma	RAPIDEX BROJ - ULJA0167
	Q8 RUBENS 00	18 kilograma	RAPIDEX BROJ - ULJA0184
	Q8 RUBENS WB/b	0,4 kilograma	RAPIDEX BROJ - ULJA0166

ULJE ZA KOČNICE I AUTOMATSKJE MENJAČE	Q8 BRAKE FLUID DOT4	0,25 litara	RAPIDEX BROJ - ULJA0163
	Q8 AUTO 15 ATF	20 litara	RAPIDEX BROJ - ULJA0182
	Q8 AUTO 15 ATF	1 litra	RAPIDEX BROJ - ULJA0165
	Q8 LHM MINERALNO ULJE	1 litra	RAPIDEX BROJ - ULJA0164
	-	-	-

HIDROL	Q8 HAYDN 10	208 litara	RAPIDEX BROJ - ULJA0240
	Q8 HAYDN 32	208 litara	RAPIDEX BROJ - ULJA0218
	Q8 HAYDN 46	208 litara	RAPIDEX BROJ - ULJA0212
	Q8 HAYDN 46	20 litara	RAPIDEX BROJ - ULJA0215
	Q8 HAYDN 68	208 litara	RAPIDEX BROJ - ULJA0213
	Q8 HAYDN 68	20 litara	RAPIDEX BROJ - ULJA0216
	Q8 HELLER 46	208 litara	RAPIDEX BROJ - ULJA0214
	Q8 HELLER 68	208 litara	RAPIDEX BROJ - ULJA0191
	-	-	-

ULJE ZA MENJAČ I DIFERENCJAL	Q8 T 60	75W-80	60 litara	RAPIDEX BROJ - ULJA0238
	Q8 T 60	75W-80	20 litara	RAPIDEX BROJ - ULJA0241
	Q8 T 36	75W-90	208 litara	RAPIDEX BROJ - ULJA0237
	Q8 T 65	75W-90	60 litara	RAPIDEX BROJ - ULJA0180
	Q8 T 65	75W-90	20 litara	RAPIDEX BROJ - ULJA0178
	Q8 T 35	80W	20 litara	RAPIDEX BROJ - ULJA0143
	Q8 T 55	80W-90	208 litara	RAPIDEX BROJ - ULJA0200
	Q8 T 55	80W-90	60 litara	RAPIDEX BROJ - ULJA0199
	Q8 T 55	80W-90	20 litara	RAPIDEX BROJ - ULJA0139
	Q8 T 55	80W-90	1 litra	RAPIDEX BROJ - ULJA0188
	Q8 T 55	85W-140	20 litara	RAPIDEX BROJ - ULJA0181
	-	-	-	-



office@rapidex.co.rs
www.rapidex.co.rs



NOVI SAD

Novosadski put 160
21000 Novi Sad
Srbija

Tel./Fax.

021 651 0521
021 651 0522
021 651 0523
021 651 1228
021 651 2254
060 824 8801

BEOGRAD ISTOK

Milošev kladenac BB

Tel/fax.

011 406 59 48
011 406 67 82
011 406 67 83
060 824 8804

BEOGRAD ZAPAD

Tel.

060 824 8817

PARAĆIN

Carice Milice 54

Tel/fax

035 8 567 611
035 8 567 671
060 824 8833

ČAČAK

Konjevići bb

Tel.

060 824 8821

LOZNICA

Bulevar Dositeja Obradovića 70

Tel.

015 877 883
015 877 884
060 824 8810

VRANJE

Ivana Meštrovića 27

Tel.

017 410 088
060 824 8835

NOVI PAZAR

Save Kovačevića br.300

Tel.

020 315 156,
060 824 8824

SOMBOR

XII Vojvođanske udarne
brigade 130

Tel.

025 461 481
060 824 8850



