KATALOG REZERVNIH DELOVA ZA KOMERCIJALNA VOZILA



DAF
2016



ISO 9001:2008
VÁLTI UNIK
04.09.2016.
www.daf.com
© 2016 DAF

KATALOG REZERVNIH DELOVA ZA KOMERCIJALNA VOZILA



www.rapidex.co.rs

DAF

2016





NOVI SAD

Novosadski put 160
21000 Novi Sad
Srbija

Tel./Fax.

021 651 0521
021 651 0522
021 651 0523
021 651 1228
021 651 2254
060 824 8801

e-mail: office@rapidex.co.rs



BEOGRAD

Milošev kladenac BB

Tel./Fax.

011 406 59 48
011 406 67 82
011 406 67 83
060 824 8804





PARAĆIN

Carice Milice 54

Tel./Fax.
035 8 567 611
035 8 567 671
060 824 8833



ČAČAK

Konjevići bb

Tel./Fax.
032 559 0037
060 824 8821





LOZNICA

Bulevar Dositeja Obradovića 70

Tel.

015 877 883
015 877 884
060 824 8810



SUBOTICA

Beogradski put 21

Tel.

024 556 246
060 824 8862



NOVI PAZAR

Save Kovačevića 300

Tel.

020 315 156
060 824 8824



VRBAS

Ivana Milutinovića 11

Tel.

021 700 087
060 824 8806



VRANJE

Ivana Meštrovića 27

Tel.

017 410 088
060 824 8835



NIŠ

Bulevar 12. Februar 152

Tel./Fax.

018 585 824
060 824 8874



SOMBOR

XII Vojvodanske udarne brigade 130

Tel.

025 461 481
060 824 8850



BIJELJINA RAPIDEX DOO

Pantelinska 1

Tel./Fax.

+387 55 247 687



VAŽNA NAPOMENA: OVAJ KATALOG JE IZRAĐEN ZA SOPSTVENE POTREBE I NEĆE SE KORISTITI ZA JAVNO PUBLIKOVANJE U CELINI ILI U POJEDINAČNIM SEGMENTIMA. KORIŠTENI MATERIJAL SLUŽI ISKLJUČIVO U SVRHU IDENTIFIKOVANJA POJEDINIH REZERVNIH DELOVA KOJI SE NALAZE U ASORTIMANU ROBA RAPIDEX TRADE I U DRUGE SVRHE SE NE SME KORISTITI. ORIGINALNI BROJEVI PROIZVOĐAČA VOZILA I REZERVNIH DELOVA KORISTE SE ZA SVRHU POREĐENJA I NE SMEJU BITI POMENUTI NA RAČUNIMA KUPCA.

SADRŽAJ:

1.0 MOTOR

1.1	Delovi motora	16
1.2	Pumpe vode	18
1.3	Termostati	19
1.4	Španeri motora i prenosni kaiševi	20
1.5	Turbo kompresori	23
1.6	Hlađenje motora (Visko ventilatori, hladnjaci, interkuleri, hladnjaci ulja i ekspanzione posude)	24
1.7	Hlađenje i grejanje kabine (Hladnjaci klime, kompresori klime i izmenjivači toplote).....	26
1.8	Creva vode i interkulera	27
1.9	Filteri	30
1.10	Napajanje gorivom	34
1.11	Davači i senzori	36
1.12	Izduvni sistemi	37

2.0 KVAČILO I TRANSMISIJA

2.1	Setovi kvačila i elementi	44
2.2	Centralni ležajevi kardana	46
2.3	Cilindri menjača	47

3.0 KOČIONA PNEUMATIKA I HIDRAULIKA

3.1	Kompresori i delovi	50
3.2	Isušivači vazduha i filteri	52
3.3	Ventili kočionog sistema	54
3.4	Ventili nivelacije kabine	59
3.5	Cilindri tristop i membranski	60
3.6	Ventili ABS, EBS i ECAS	62
3.7	Elektronika ABS i ECAS	65
3.8	Senzori	66
3.9	Cilindri kvačila	68
3.10	Pribor kočionog sistema	70
3.11	WABCO i WABCOWÜRTH dijagnostika	79

4.0 KOMPONENTE KOČIONOG SISTEMA

4.1	Disk kočnica	88
4.2	Kočione pločice	90
4.3	Čeljusti kočnica	91
4.4	Doboši kočnica	92
4.5	Kočione obloge	93
4.6	Šteleri kočnica	94
4.7	Glavčine točka, ležajevi i semerinzi	96
4.8	Vijci i navrtke	99

5.0 ELEMENTI OGIBLJENJA I UPRAVLJANJA

5.1	Amortizeri	102
5.2	Vazdušni jastuci	105
5.3	Gibnjevi	108
5.4	Delovi stabilizatora	109
5.5	Delovi rukavca	110
5.6	Spone i delovi spona	111
5.7	Uporne spone	114
5.8	V spone	115

6.0 KABINA I DELOVI KABINE

6.1	Delovi kabine	118
6.2	Ogledala i delovi ogledala	138
6.3	Cilindri i pumpe za dizanje kabine	140
6.4	Elementi za oslanjanje kabine	141
6.5	Uređaji za pranje vetrobranskog stakla	144
6.6	Mehanizam vrata	145

7.0 ELEKTRIČNE INSTALACIJE

7.1	Farovi	148
7.2	Pokazivači pravca	152
7.3	Stop i gabaritna svetla	153
7.4	Rotacione lampe	157
7.5	Sijalice, osigurači i tahograf listići	160
7.6	Kablovi električne instalacije	165
7.7	Kombinovani prekidači pod volanom	168
7.8	Pribori	169
7.9	Anlaseri i alternatori	170

8.0 PRIBORI

8.1	Obeležavajuće table i pribori A.D.R.	174
8.2	Oprema	189
8.3	Pribor za osiguravanje tereta	192
8.4	Lanci za sneg	194
8.5	Vučne kuke	196
8.6	Grejanje kabine	199

9.0 ULJA I MAZIVA

9.1	Ulja i maziva	207
-----	---------------------	-----

1.0 MOTOR



1.0 MOTOR





1.1	Delovi motora	16
1.2	Pumpe vode	18
1.3	Termostati	19
1.4	Španeri motora i prenosni kaiševi	20
1.5	Turbo kompresori	23
1.6	Hlađenje motora (Visko ventilatori, hladnjaci, interkuleri, hladnjaci ulja i ekspanzione posude)	24
1.7	Hlađenje i grejanje kabine (Hladnjaci klime, kompresori klime i izmenjivači toplote)	26
1.8	Creva vode i interkulera	27
1.9	Filteri	30
1.10	Napajanje gorivom	34
1.11	Davači i senzori	36
1.12	Izduvni sistemi	37

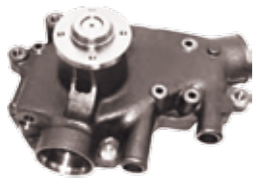

DELOVI MOTORA								
Poz.	Naziv	Federal Mogul broj	Mahle / Miba broj	KS broj	Dimenzije (mm)	Tip motora	OE broj	RAPIDEX broj
1.	Klip KPL	87-743400-30	21 30 900	94 556 600	130	XF250, 280, 315, 355	1620368	MOTO1807
2.	Košuljica	14-021410-00	213 WT 03	88 640 110	130	XF250, 280, 315, 355	1699329	MOTO1806
3.	Karike	08-743400-00	213 62 N0	800005010	130	XF250, 280, 315, 355	683192	MOTO1851
4.	Ležajevi radilice - leteći	71-3866/6	-	77 880 600	88 x 92,5 x 39	XF250, 280, 315, 355	1290488	MOTO1852
5.	Ležajevi radilice - leteći	71-4785	-	-	88 x 92,5 x 39	XF250, 280, 315, 355	1621000	MOTO2223
6.	Ležajevi radilice - leteći	H005/7	-	77 182 600	98 x 103 x 39,15	XF250, 280, 315, 355	681294	MOTO1853
7.	Aksijalni ležaj radilice	A142/4	-	-	108 x 125 x 23,62	XF250, 280, 315, 355	682132	MOTO1813
8.	Čaura klipnjače	55-3950	-	77 887 690	52 x 56 x 45,90	XF250, 280, 315, 355	1326711	MOTO1817
9.	Čaure bregaste osovine	N194/4	-	-	76 x 80 x 22	XF250, 280, 315, 355	1307213	MOTO2224

DELOVI MOTORA								
Poz.	Naziv	Federal Mogul broj	Reinz broj	Elring broj	Dimenzije (mm)	Tip motora	OE broj	RAPIDEX broj
10.	Set zaptivača glave	-	02-27205-03	851.341	130	XF250, 280, 315, 355	683337	MOTO2225
11.	Set zaptivača glave	-	02-27205-04	181.861	130	XF250, 280, 315, 355	683373	MOTO1636
12.	Set zaptivača glave	-	02-27205-05	181.861	130	XF250, 280, 315, 355	683532	MOTO1446
13.	Set zaptivača glave	-	02-35540-01	-	130	MX265, 300, 340, 375	683657	MOTO1700
14.	Set zaptivača glave	-	02-36175-01	497.940	130	XE250, 280, 315, 355, 390	683494	MOTO1616
15.	Zaptivač glave	-	61-27205-10	760.082	130	XF250, 280, 315, 355	1366063	MOTO1447
16.	Zaptivač glave	-	61-36175-00	497.350	130	XE250, 280, 315, 355, 390	1699517	MOTO1665
17.	Zaptivač glave	-	61-35540-00	905.990	130	MX265, 300, 340, 375	1690107	MOTO1791
18.	Semering radilice	-	81-29052-00	493.330	100 x 124 x 12	XE250, 280, 315, 355, 390	1340321	MOTO1638
19.	Semering radilice	-	81-28539-00	175.990	154 x 180 x 12	XE250, 280, 315, 355, 390	1370127	MOTO1639
20.	Semering radilice	-	81-37174-00	-	134 x 161 x 16	MX265, 300, 340, 375	1684105	MOTO1640
21.	Semering radilice	-	81-37173-00	-	166 x 191 x 16	MX265, 300, 340, 375	1684106	MOTO1641



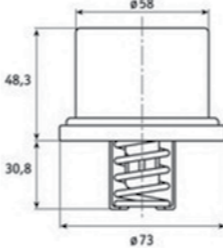
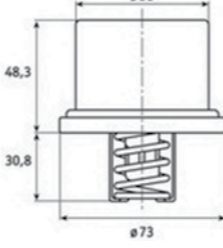
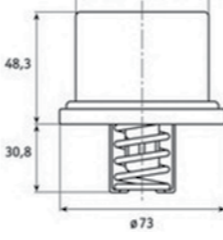

DELOVI MOTORA						
Poz.	Naziv	Tip motora	OE broj	Dimenzije (mm)	Ugao i kraj stabla	RAPIDEX broj
22.	Ventil usisni	XF250, XF280	1342220	45,5 x 9 x 163,8	70° I žleb	MOTO2235
23.	Ventil izduvni	XF250, XF280	1362696	42,5 x 9 x 158,8	45° I žleb	MOTO2236
24.	Ventil usisni	XE390, XF315, 355	1603846	45,5 x 9 x 163,8	70° I žleb	MOTO2237
25.	Ventil izduvni	XE390, XF315, 355	1362696	42,5 x 9 x 158,8	45° I žleb	MOTO2236
26.	Vodica usisnog/izduvnog ventila	XE390, XF315, 355, XF250	1313683	9 x 15,04 x 76,50	-	MOTO2238

PUMPE VODE						
Slika	Poz.	Model vozila	Tip motora	Frimatec broj	OE broj	RAPIDEX broj
	1.	95XF	XF280	220953	1609871	MOTO0071
	2.	85CF, 95XF, CF85, XF95	XE 250 C XE 280 C XE 315 C XE 355 C XE 390 C	2201080	1609853	MOTO2091
	3.	XF105, 95XF, CF85, XF95	1260 VS	2201092	1653974	MOTO1793
	4.	LF55, 65, 75, 85, 95	NS 133 M RS 200 WS 295 M WS 268	2201150	1426628	MOTO3323
	5.	LF45, LF55	BE 123 C FR 136 S1	220884	1399689	HLAØ0923

TERMOSTATI						
Slika	Poz.	Model vozila	T [°C]	KBP	OE broj	RAPIDEX broj
	1.	CF85, 95XF	76°C	THCT16958	222730	MOTO2175
	2.	CF85, XF95,	83°C	THCT19099.83	1303061	MOTO2174
	3.	XF95, XF105	87°C	THCT19099.87	1661375	MOTO2173



ŠPANERI

Poz.	Slika	Model vozila	OE broj	KBP	RAPIDEX broj
1.		LF45, LF55, CF65	1399691	VKM CV52006	MOTO1115
2.		CF85, XF95	1614978	VKM CV57002	MOTO0153
3.		95XF, CF85, XF95	1628148	APV2473	MOTO1743
4.		CF85, XF105	1690115	APV2814 T38665	MOTO3042
5.		CF85, XF105	1695242	APV2813 T38664	MOTO2986

ROLERI

Poz.	Model vozila	OE broj	KBP	RAPIDEX broj
1.	CF75, CF 85, XF95	1356457	APV2624	MOTO2338
2.	XF95, XF105	1699240	APV2812 T36528	MOTO2992
3.	XF105	271646	271646	MOTO1492
4.	XF105	271647	271647	MOTO1474

SETOVI (ŠPANER, ROLER, KAIŠ)

Poz.	Model vozila	OE broj	KBP	RAPIDEX broj
1.	CF, XF105, XF105 EEV	1695242 1699240 1638698	<u>K017PK1753ES</u> T38664 T36528 7PK1753	MOTO3046
2.	CF	1690115 1661954	<u>K019PK1425ESXS</u> T38665 9PK1425	MOTO3047
3.	XF105	1690115 1661948	<u>K019PK1380ESXS</u> T38665 9PK1380	MOTO3048
4.	XF105 EEV	1690115 1833079	<u>K019PK1360ESXS</u> T38665 9PK1360	MOTO3049



KLINASTI I PK KAIŠEVI

Poz.	Dimenzija (mm)	Model vozila	RAPIDEX broj
1.	13 x 1000	95XF, XF95	REME0216
2.	13 x 1025	95XF	REME0217
3.	13 x 1225	95XF	REME0067
4.	13 x 1275	95XF, XF95	REME0219
5.	13 x 1300	CF75, CF85	VESA0541
6.	13 x 1600	95XF, XF95	REME0223
7.	7PK 1753	CF, XF105	MOTO3046
8.	7PK 1755	XF105	REME0108
9.	8PK 1215	LF45	REME0012
10.	8PK 1225	65CF, CF65	REME0116
11.	8PK 1520	65CF, CF65	REME0128
12.	8PK 1716	95XF, XF95,	VESA0945
13.	8PK 1720	CF85, XF95	REME0139
14.	8PK 2050	CF85	REME0156
15.	8PK 2380	75CF, CF75	REME0159
16.	9PK 1360	XF105 EEV	REME0670
17.	9PK 1380	XF105	MOTO3174
18.	9PK 1425	CF	REME0669

TURBO KOMPRESORI

Poz.	Model vozila	OE broj	RAPIDEX broj
1.	85XF, 95XF	1319283	MOTO0950
2.	85CF, 95XF, CF85	1377426	MOTO0951
3.	95XF	1319282	MOTO0952
4.	XF95	1642316	MOTO2922





VISKO VENTILATORI

Poz.	Model vozila	Dimenzija (mm)	OE broj	RAPIDEX broj
1.	LF45, 75CF, 85CF, 95XF	Ø 200 mm	1349834	MOTO2859
2.	95XF	Ø 203 mm	1436105	MOTO1605
3.	XF105	Ø 256/275 mm	1916598	MOTO2605

HLADNJACI

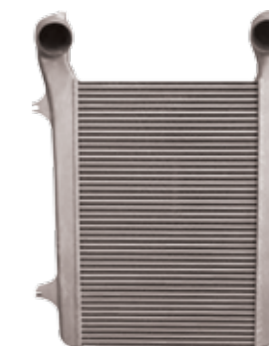
Poz.	Model vozila	Dimenzija (mm)	OE broj	RAPIDEX broj
1.	LF45	523 x 529 x 58	1407721	HLAĐ0637
2.	95XF	1067 x 748 x 42	1326966	HLAĐ0272
3.	XF95	1067 x 748 x 42	1617341	HLAĐ0275
4.	XF105	1065 x 739 x 40	1739550	HLAĐ0487
5.	XF105	1065 x 739 x 40 bez rama	1739550	HLAĐ0864

INTERKULERI

Poz.	Model vozila	Dimenzija (mm)	OE broj	RAPIDEX broj
1.	95	608 x 852 x 52	1287157	HLAĐ0269
2.	95XF	554 x 852 x 52	1327673	HLAĐ0273

HLADNJACI ULJA

Poz.	Model	OE broj	RAPIDEX broj
1.	95XF	1667565	MOTO2302
2.	CF85, XF95, BOVA	1667576	MOTO2310
3.	CF85, XF95, XF105	1780140	MOTO3218

EKSPANZIONE POSUDE

Poz.	Model vozila	Dimenzija (mm)	OE broj	RAPIDEX broj
1.	65CF, 75CF, 85CF, CF75, CF85	594 x 381 x 293	1371329	HLAĐ0741
2.	95XF, XF95	547 x 337 x 104	1295910	HLAĐ0400
3.	XF105	555 x 345 x 105	1626237	HLAĐ0493

HLADNJACI KLIME

Poz.	Model vozila	Dimenzija (mm)	OE broj	RAPIDEX broj
1.	CF75, CF85	455 x 432 x 16	1371355	HLAĐ0956

KOMPRESORI KLIME

Poz.	Model vozila	Opis	OE broj	RAPIDEX broj
1.	65CF, 75CF, 85CF, 95XF, XF95	-	1638737	HLAĐ0873
2.	CF85, XF105	-	1685170	HLAĐ0874

IZMENJIVAČI TOPLOTE

Poz.	Model vozila	Dimenzija (mm)	OE broj	RAPIDEX broj
1.	95XF	370 x 189 x 42	1335401	HLAĐA0248

CREVA VODE					
Slika	Poz.	Model vozila	Dimenzije (mm)	OE broj	RAPIDEX broj
	1.	CF85	25 x 34 x 460	1355106	HLAĐ0193
	2.	CF85	60 x 60 x 345	1372303	HLAĐ0192
	3.	CF85	60 x 60 x 1250	1371353	HLAĐ0191
	4.	95XF	22 x 26 x 410	1293808	HLAĐ0190
	5.	95XF	31 x 42 x 440	1290141	HLAĐ0189
	6.	95XF	60 x 60 x 620	1297739	HLAĐ0188
	7.	95XF	60 x 60 x 440	1338931	HLAĐ0187
	8.	95XF	60 x 70 x 400	1293809	HLAĐ0088
	9.	XF95	60 x 60 x 400	1353922	HLAĐ0087
	10.	XF95	30 x 30 x 530	1347468	HLAĐ0086

CREVA VODE					
Slika	Poz.	Model vozila	Dimenzije (mm)	OE broj	RAPIDEX broj
	11.	XF95	60 x 60 x 530	1440636	HLAĐ0194
	12.	XF95	20 x 26 x 450	1399816	HLAĐ0724
	13.	XF95, XF105	59 x 60 x 560	1683774	HLAĐ0720
	14.	XF95, XF105	50 x 60 x 580	1670856	HLAĐ0721
	15.	XF95, XF105	30 x 30 - 26 x 490	1645506	HLAĐ1001
	16.	XF95, XF105	20 x 26 x 300	1638928	HLAĐ1002
	17.	XF95, XF105	-	1689073	HLAĐ0698
	18.	XF95, XF105	-	1689072	HLAĐ0999
	19.	XF95, XF105	-	1643771	HLAĐ1004
	20.	XF95, XF105	-	1340132	HLAĐ1000

CREVA VODE					
Slika	Poz.	Model vozila	Dimenzije (mm)	OE broj	RAPIDEX broj
	21.	XF95, XF105	-	1786291	HLAĐ1005
	22.	XF95, XF105	-	1786292	HLAĐ1006
	23.	XF95, XF105	-	1638927	HLAĐ1003
	24.	XF95, XF105	-	1658084	HLAĐ1071

CREVA INTERKULERA					
Slika	Poz.	Model vozila	Dimenzija (mm)	OE broj	RAPIDEX broj
	1.	F85, F95, CF75	100 x 130	1286075	HLAĐ0329
	2.	CF75, CF85, XF95	50 x 55 x 110	1650940	HLAĐ0332
	3.	95XF, XF95	101 x 117	1204236	HLAĐ0330
	4.	CF85, XF95, XF105	50 x 60 x 30 x 120	1149578	HLAĐ0333
	5.	95XF, XF95	100 x 425	1378391	HLAĐ0727
	6.	XF105	97 x 175	1600366	HLAĐ0728

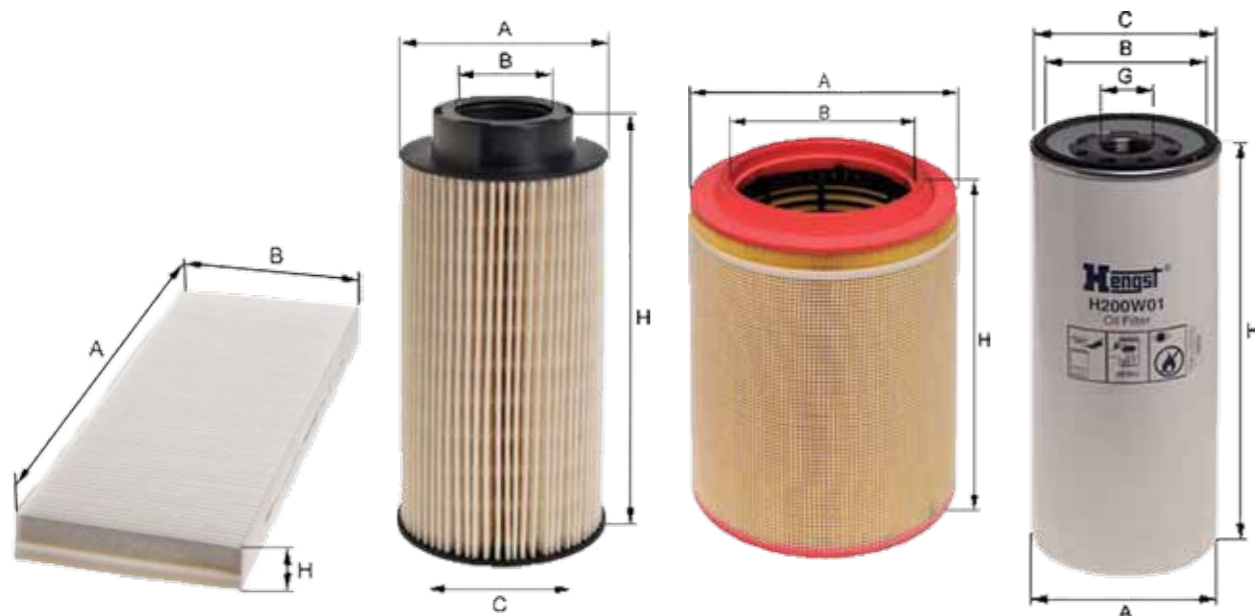
FILTERI ULJA

Poz.	Hengst broj	A (mm)	B (mm)	C (mm)	G (mm)	H (mm)	Model vozila	OE broj	RAPIDEX broj
1.	H19W10	93,50	62,00	70,00	M27 x 2	174,00	LF45, LF55, CF65 2001-	1399494	FILT0354
2.	H300W01	136,00	100,00	111,00	1 1/2-16-U	308,00	85, 95, F2900, F3200	267714	FILT0140
3.	H300W02	136,00	101,00	111,00	M42 x 2	308,00	85CF 1998-2000, 95XF 1997-2002	1310901	FILT0311
4.	H300W03	118,50	101,50	117,80	2 1/4-12-U	289,50	95XF 530, 1997-2002	1288430	FILT0203
5.	E34HD151	110,50	56,50	56,50	-	149,00	CF75, CF85 2001-, XF95 2002-2006	1397764	FILT0702
6.	E43HD213	109,00	69,00	69,00	-	220,00	CF75, CF85 2001-, XF95 2002-2006	1397765	FILT0846
7.	E89HD213	110,50	56,50	56,50	-	220,00	CF85 2006-, XF105 2005	1629393	FILT0710

FILTERI GORIVA

Poz.	Hengst broj	A (mm)	B (mm)	C (mm)	G (mm)	H (mm)	Model vozila	OE broj	RAPIDEX broj
1.	H18WK05	93,00	62,00	72,00	M20 x 1,5	209,00	LF45, LF55, CF65 2001-	1399760	FILT0196
2.	H18WK04	93,50	62,00	72,00	M16 x 1,5	210,00	75, 85 1992-1998 95 1987-1998	0247138	FILT0613
3.	H17WK03	95,00	62,00	72,00	M16 x 1,5	143,00	65, 75, 85 1992-2000 95 1987-1998	1318695	FILT0520
4.	H18WDK03	93,00	62,00	71,00	M22 x 1,5	144,00	95XF 1997-2002	1345335	FILT0259
5.	E66KPD36	105,00	46,00	14,00	-	202,00	CF75, CF85 2001-, XF95 2002-2006	1784782	FILT0274
6.	E70KPD98	89,00	46,00	18,00	-	247,60	CF75, CF85 2001-, XF95 2002-2006	1450184	FILT0271
7.	E82KPD36	104,00	46,00	20,00	-	249,50	CF75, CF85 2001-, XF105 2005-	1699168	FILT0211
8.	-	-	-	-	-	-	XF106	1852005	FILT1321

SEPARATOR GORIVA

Poz.	Hengst broj	A (mm)	B (mm)	C (mm)	G (mm)	H (mm)	Model vozila	OE broj	RAPIDEX broj
1.	H296WK	93,50	62,50	70,00	M20 x 1,5	182,00	LF45, LF55 2001-	1618993	FILT0161
2.	H190WK	93,5	62,50	70,00	M20 x 1,5	183,00	LF45, LF55, CF65 2001-	1437070	FILT0569
3.	H7090WK30	108,00	91,00	-	1-14 UNS	157,00	CF65, CF75, CF85 2001-, XF95 2002-2006, XF105 2005-	1296851	FILT0210
4.	H710WK	108,00	93,00	103,00	1-14 UNS	231,50	CF65, CF75, CF85, 95XF 2001-, XF95 2002-2006 XF105 2005-	1433649	FILT0306

FILTERI VAZDUHA									
Poz.	Hengst broj	A (mm)	B (mm)	C (mm)	G (mm)	H (mm)	Model vozila	OE broj	RAPIDEX broj
1.	E498L	214,00	124,00	-	-	339,00	LF45, LF55 2001-	1433690	FILT0152
2.	E765L	247,00	160,00	-	-	389,00	LF45, LF55 2001-	1679397	FILT0775
3.	E115L	198,00	103,00	9,00	-	376,00	F1700-3600, F95, N2800	265045	FILT0075
4.	E116L	228,00	116,00	10,50	-	381,00	F2100-2500, SB3000	112294	FILT0224
5.	E117L	243,00	132,00	10,50	-	496,00	F2100-2800, SB3000	607179	FILT0324
6.	E118L	302,00	191,00	10,50	-	473,00	80.330 ATI	694218	FILT0323
7.	E218L	302,00	191,00	10,50	-	381,00	F2900-F3200, F85, F95	667078	FILT0058
8.	E214L	243,00	132,00	10,50	-	376,00	SB220	393561	FILT0300
9.	E542L	265,00	170,00	-	-	414,00	CF65, CF75 2001-	1363023	FILT0813
10.	E541L	265,00	170,00	-	-	481,00	CF85 2001-	1363024	FILT0688
11.	E313L	281,50	147,50	-	-	525,00	95XF 1997-2002	129509	FILT0239
12.	E702L	281,50	147,50	-	-	507,00	CF75, CF85 2001- 95XF 1997-2002 XF95 2002-2005	1664524	FILT0213
13.	E794L	281,50	147,00	-	-	510,00	XF105 2005-	1638054	FILT0464
14.	E1084L	281,50	147,00	-	-	507,00	XF105 2013-	1854407	FILT1011

FILTERI KABINE									
Poz.	Hengst broj	A (mm)	B (mm)	C (mm)	G (mm)	H (mm)	Model vozila	OE broj	RAPIDEX broj
1.	E2927LI	227,00	107,00	-	-	20,00	LF45, LF55	1600428	FILT0197
2.	E969LI	260,00	164,00	-	-	38,00	CF65, CF75, CF85	1362124	FILT0264
3.	E944LI	324,00	238,00	-	-	23,50	95XF, XF95, XF105	1658991	FILT0221

OSTALI FILTERI									
Poz.	Hengst broj	A (mm)	B (mm)	C (mm)	G (mm)	H (mm)	Model vozila	OE broj	RAPIDEX broj
1.	E10H02	58,00	18,50	18,50	-	100,00	SVI MODELI Filter hidraulike volana	0229348	FILT0214
2.	Z13D94	97,80	12,50	10,00	-	119,00	CF75, PE183/228/265C	1376481	FILT0202
3.	Z12D64	97,80	14,50	14,50	-	119,00	85CF, 95XF, CF85, XF95	1310891	FILT0247
4.	Z16D183	103,50	10,90	-	-	144,50	XF105 2005-	1643072	FILT0436
5.	H100WL	76,50	63,00	72,00	M16 x 1,5	119,50	LF45, LF55 CF65, CF75, CF85 XF105	1686587	FILT0136
6.	E101UD178 Ad blue	69,00	25,00	-	-	75,00	LF45, LF55 CF65, CF75, CF85 XF105	1649425	FILT0015

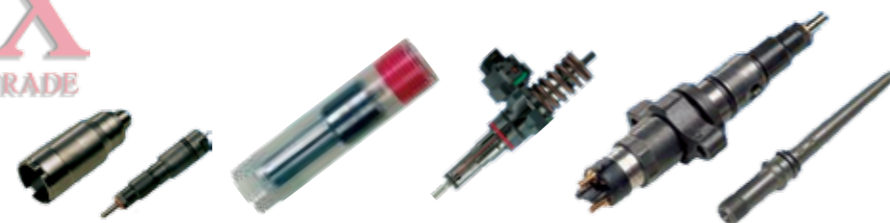

BRIZGALJKE I ULOŠCI BRIZGALJKI

Poz.	Model vozila	Tip motora	KBP	OE broj	RAPIDEX broj
1.	F95	WS222-315G	DLLA145S1160	1207731	NAP.0089
2.	F85, F95	WS222-315G	DLLA152S1277	1284294	NAP.0090
3.	85CF, 95XF	XF250/XE250C- XF355MC	DLLA155P657	1315101	NAP.0091
4.	95XF. 310 ATI	WS225	DLLA140S1117	066130	NAP.0092
5.	95XF.300, 330, 360	WS222G, WS242, WS268G	DLLA145S1161	1207730	NAP.0093
6.	95XF.350, 380	WS259, WS282	DLLA140S1116	066131	NAP.0094
7.	95XF.430	WS315M	DLLA152S1280	1285073	NAP.0095
8.	95XF	-	DLLA153P810	1350083	NAP.0016

AC PUMPE







Poz.	Model vozila	OE broj	RAPIDEX broj
1.	F85, 95, 85CF, 95XF	1339048	NAP.0169
2.	75, 85CF, 95XF, XF95	1332609	NAP.0170
3.	XF95 EURO III	1339200	NAP.0372



REZERVOARI GORIVA

Poz.	Model vozila	Dimenzija (mm)	Zapremina (l)	RAPIDEX broj
1.	UNIVERZALNI	2300 x 670 x 620	870	NAP.0184
2.	F85, F85C, F95, F95XF	1460 x 720 x 720	700	NAP.0185

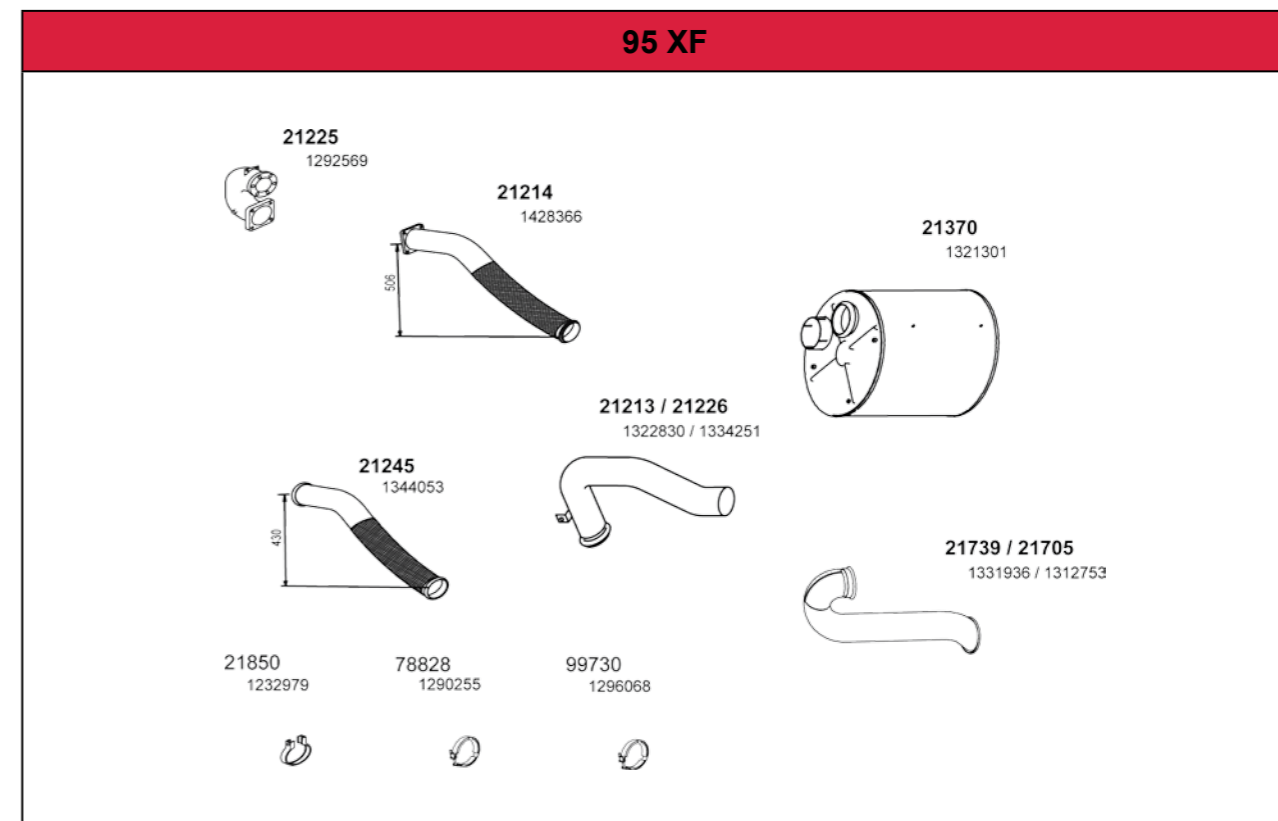

POKLOPCI

Poz.	Naziv	Model vozila	OE broj	RAPIDEX broj
1.	POKLOPAC REZERVOARA Ø60 mm	F75, F85, F95	109996	OPRE0455
2.	POKLOPAC REZERVOARA Ø80 mm	85CF, 95XF, CF85, XF95	1697734	OPRE0456
3.	POKLOPAC ULJA	F75, F85, F95	1277092	OPRE0457
4.	POKLOPAC EKSPANZIONE POSUDE	XF95, XF105	1685352	OPRE0458

DAVAČI I SENZORI						
Slika	Poz.	Model vozila	Tip motora	Dimenzije (mm)	OE broj	RAPIDEX broj
	1.	CF85, 95XF, XF95	-	M10 x 1	1661431	MOTO2324
	2.	F85, F95, 75CF, 85CF, 95XF, XF95	-	M18 x 1,5 120° max	1252439	ELEK0740
	3.	CF85, XF105	-	-	1607435	ELEK1509
	4.	XF105	-	-	1850746	HLAD1062
	5.	XF95	-	M14 x 1,5	1827058	ELEK2292
	6.	CF85, 95XF	-	-	1365738	MOTO3124

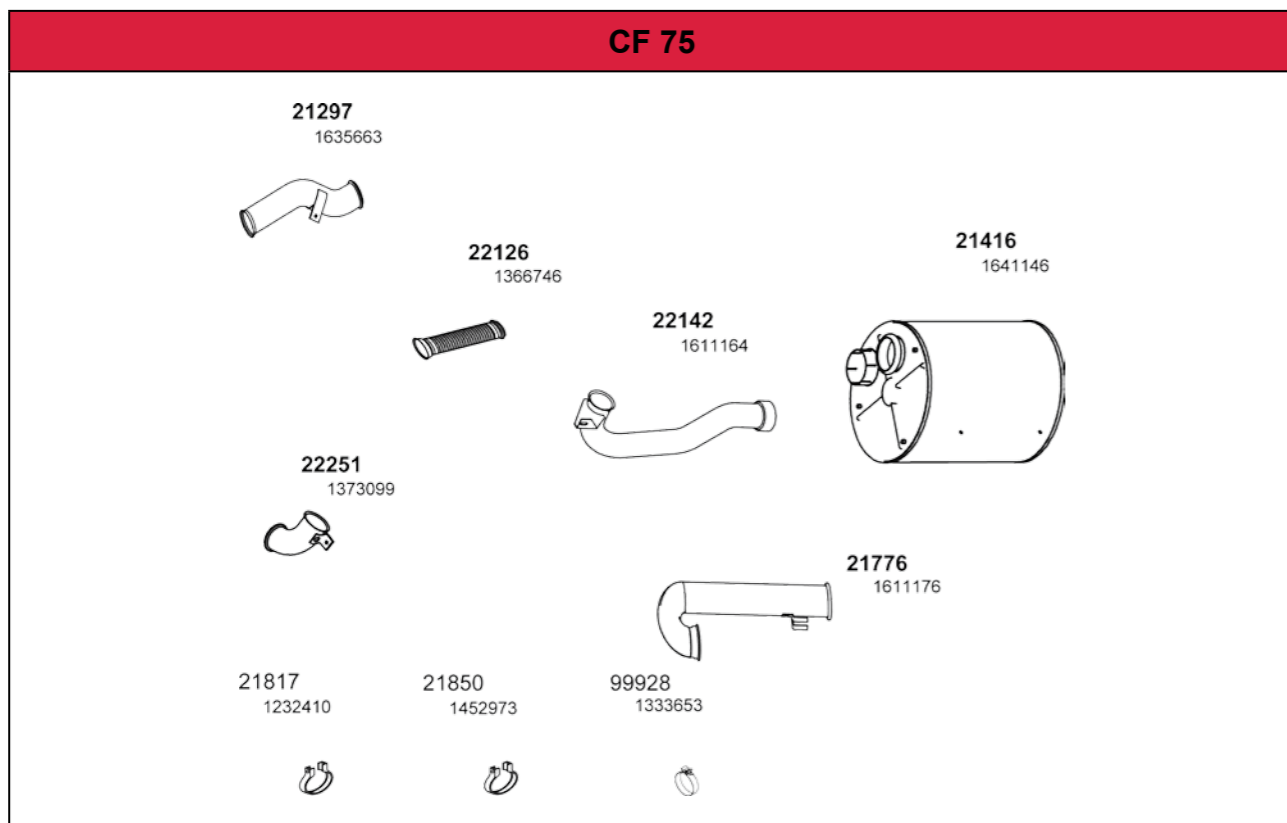

ELEMENTI IZDUVNOG SISTEMA - 95 XF				
Poz.	Naziv	Dinex broj	OE broj	RAPIDEX broj
1.	LONAC	21370	1321301	IZDU0036
2.	CEV IZDUVNA	21739	1331936	IZDU0476
3.	CEV	21213	1322830	IZDU0111
4.	CEV	21214	1428366	IZDU0113
5.	CEV	21245	1344053	IZDU0444
6.	CEV	21225	1292569	IZDU0114
7.	ŠELNA	21850	1232979	IZDU0425
8.	ŠELNA	78828	1290255	IZDU0472
9.	ŠELNA	99730	1296068	IZDU0328

ELEMENTI IZDUVNOG SISTEMA - CF 75

Poz.	Naziv	Dinex broj	OE broj	RAPIDEX broj
1.	LONAC	21416	1641146	IZDU0231
2.	CEV	21776	1611176	IZDU0419
3.	CEV	22142	1611164	IZDU0477
4.	CEV GIBLJIVA	22126	1366746	IZDU0478
5.	CEV	21297	1635663	IZDU0479
6.	CEV	22251	1373099	IZDU0480
7.	ŠELNA	21817	1232410	IZDU0481
8.	ŠELNA	21850	1452973	IZDU0425
9.	ŠELNA	99928	1333653	IZDU0482

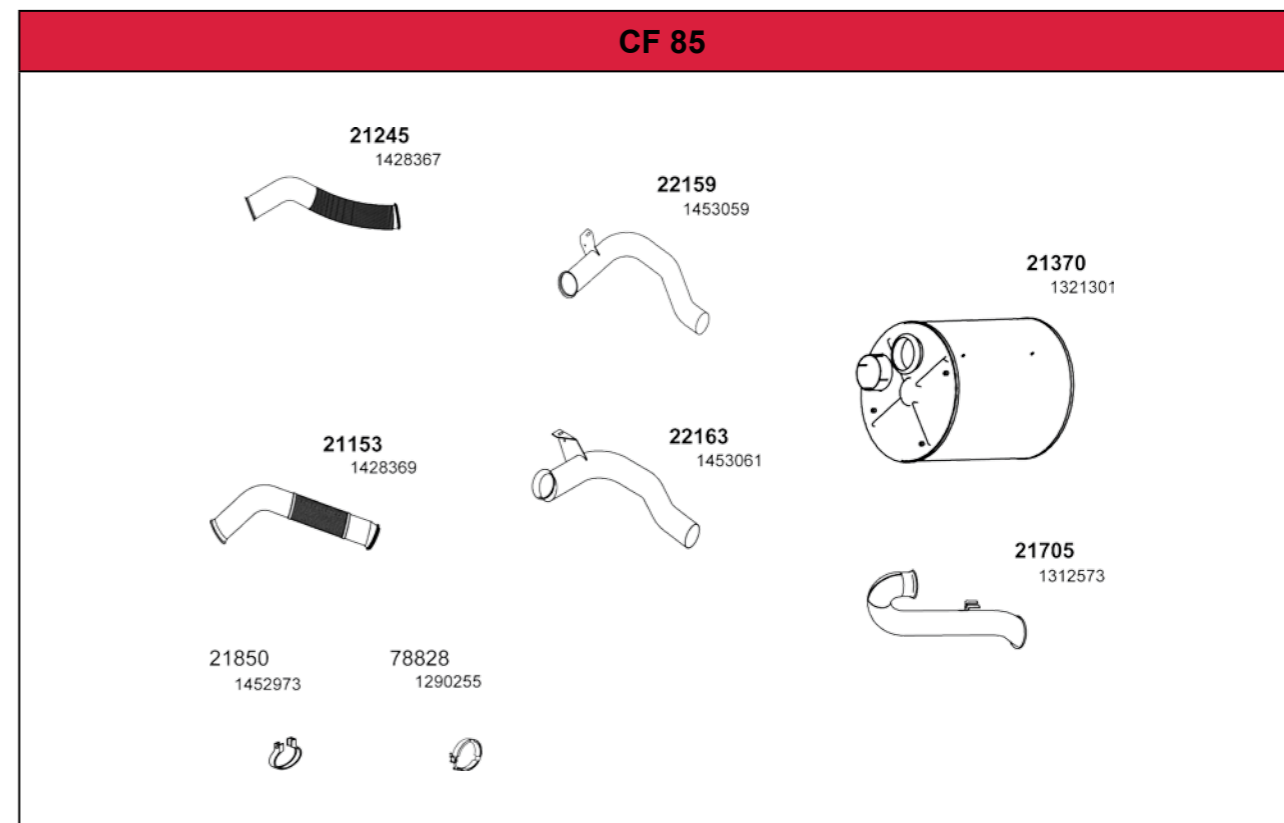
ELEMENTI IZDUVNOG SISTEMA - CF 85

Poz.	Naziv	Dinex broj	OE broj	RAPIDEX broj
1.	LONAC	21370	1321301	IZDU0036
2.	CEV IZDUVNA	21705	1312573	IZDU0109
3.	CEV IZDUVNA	22159	1453059	IZDU0483
4.	CEV	22163	1453061	IZDU0484
5.	CEV	21245	1428367	IZDU0444
6.	CEV	21153	1428369	IZDU0485
7.	ŠELNA	21850	1452973	IZDU0425
8.	ŠELNA	78828	1290255	IZDU0472

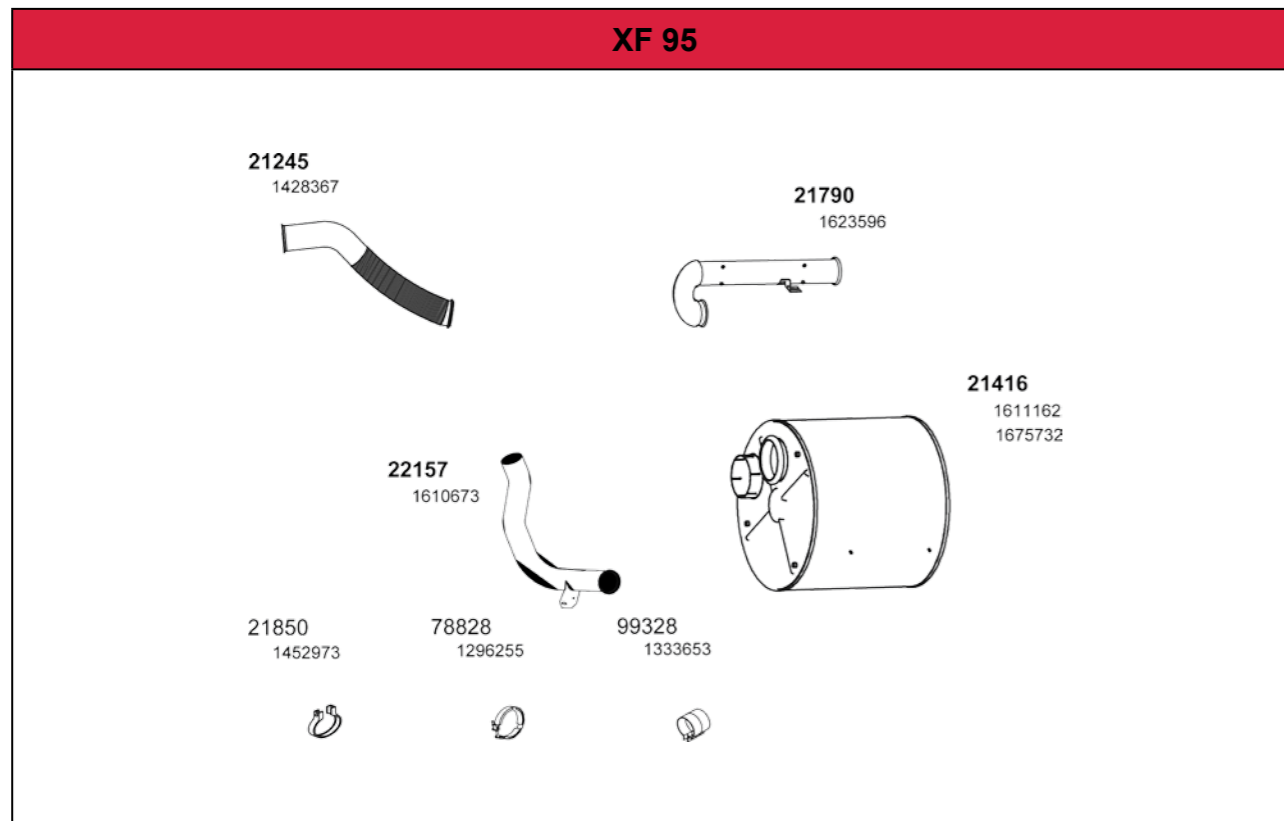

ELEMENTI IZDUVNOG SISTEMA - XF 95

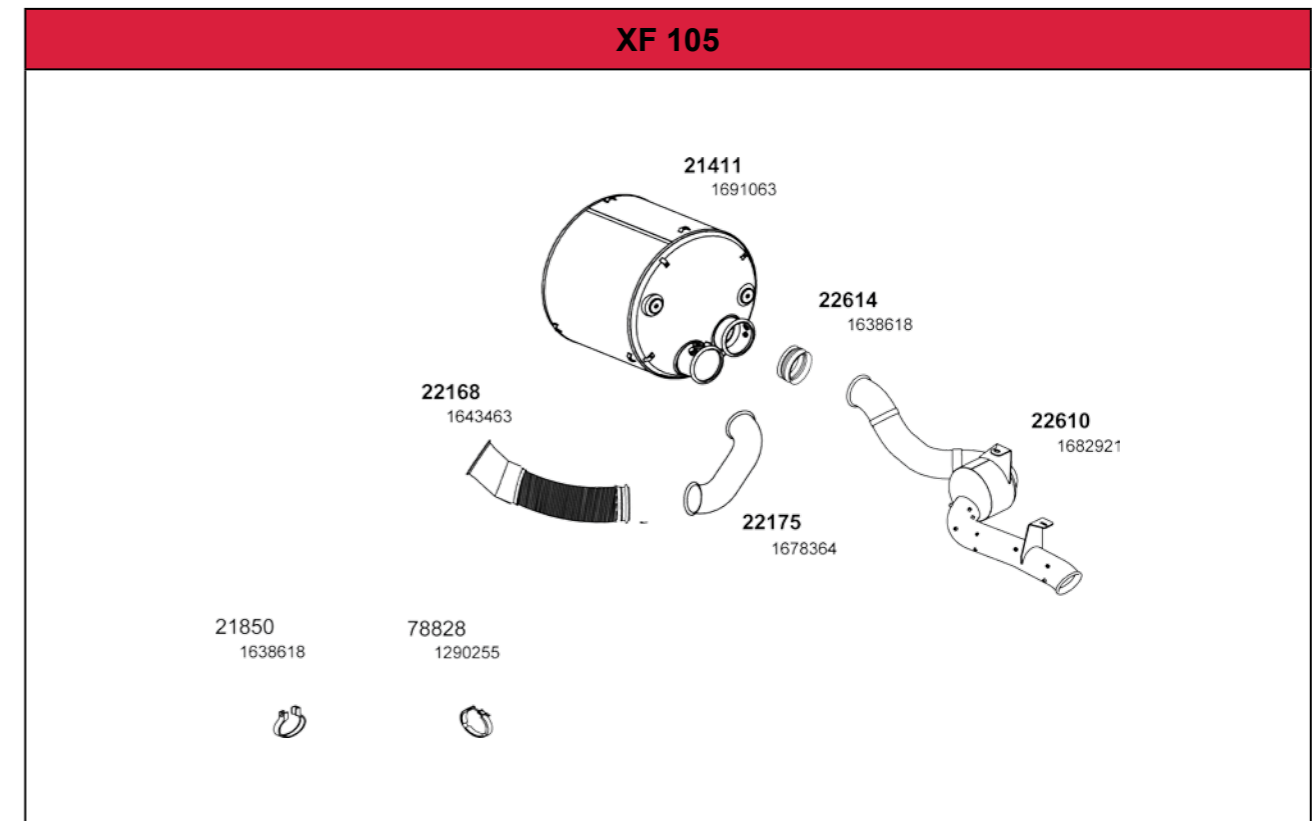
Poz.	Naziv	Dinex broj	OE broj	RAPIDEX broj
1.	LONAC	21416	1611162	IZDU0231
2.	CEV	21790	1623596	IZDU0473
3.	CEV	22157	1610673	IZDU0474
4.	CEV	21245	1428367	IZDU0444
5.	ŠELNA	21850	1452973	IZDU0425
6.	ŠELNA	78828	1296255	IZDU0472
7.	ŠELNA	99328	1333653	IZDU0396

ELEMENTI IZDUVNOG SISTEMA - XF 105

Poz.	Naziv	Dinex broj	OE broj	RAPIDEX broj
1.	LONAC	21411	1691063	IZDU0467
2.	CEV	22610	1682921	IZDU0468
3.	CEV	22175	1678364	IZDU0469
4.	CEV	22168	1643463	IZDU0470
5.	KLIZAC	22614	1638618	IZDU0471
6.	ŠELNA	21850	1638618	IZDU0425
7.	ŠELNA	78828	1290255	IZDU0472

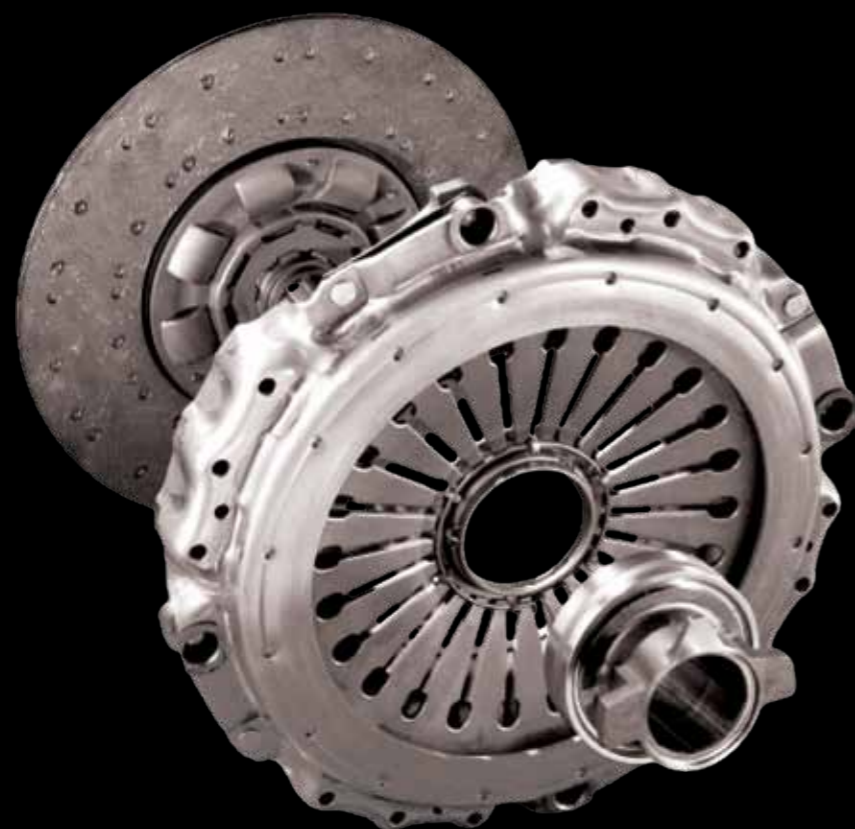
2.0 KVAČILO I TRANSMISIJA



2.0 KVAČILO I TRANSMISIJA

2.1 Setovi kvačila i elementi	44
2.2 Centralni ležajevi kardana	46
2.3 Cilindri menjača	47



SETOVI KVAČILA

Poz.	Model vozila	Prečnik	Broj zuba	KBP	OE broj	RAPIDEX broj
1.	LF45	Ø362 mm	10	3400 700 307	1740017	MENJ0733
2.	CF85, 95XF, XF95	Ø430 mm	10	3400 122 101	1625962R	MENJ0200
3.	CF85, 95XF, XF95	Ø430 mm	10	3400 700 504	1625971	MENJ0798
4.	CF85, XF105	Ø430 mm	10	3400 700 368	1816436R	MENJ0725
5.	CF85, XF105	Ø430 mm	10	3400 700 361	1814035R	MENJ0456
6.	XF95	Ø430 mm	10	3400 700 489	1820662R	MENJ1091

POTISNI LEŽAJEVI

Poz.	Slika	Model vozila	KBP	OE broj	RAPIDEX broj
1.		85CF, 95XF	3151 182 233	1287806	KVAC0094
2.		CF85, XF95, XF105	3151 000 493	1686642	KVAC0289
3.		75CF, 85CF, 95XF, CF75, CF85, XF95, XF105	3151 000 034	1780332	MENJ0282

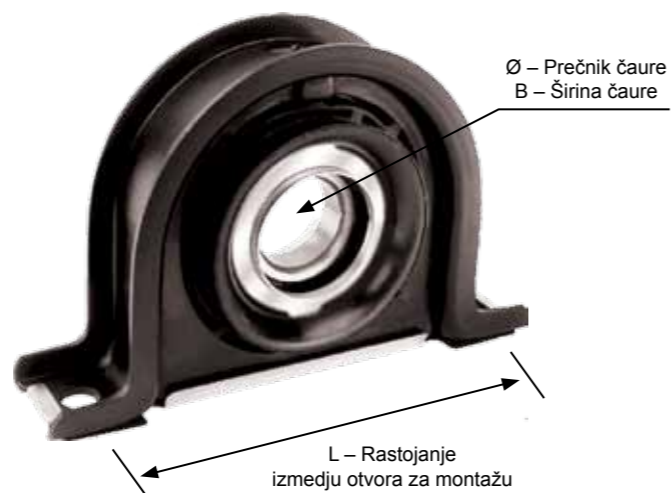



CENTRALNI LEŽAJEVI KARDANA							
Poz.	Slika	Model vozila	Ø (mm)	B (mm)	L (mm)	OE broj	RAPIDEX broj
1.		65, 75, 85, 95, 95XF	55	18	190	1298157	MENJ0309
2.		85CF, 95XF, 95XF 530, F85/95	70	20	220	1235569	MENJ0310

CILINDRI MENJAČA						
Poz.	Slika	Model vozila	Naziv	KBP	OE broj	RAPIDEX broj
1.		XF95	BIRAČ BRZINA	626260AM	1321160	MENJ0075
2.		XF95	CILINDAR KVAČILA	625942AM	1306841	MENJ0076





3.0 KOČIONA PNEUMATIKA I HIDRAULIKA



3.0 KOČIONA PNEUMATIKA I HIDRAULIKA

3.1	Kompresori i delovi	50
3.2	Isušivači vazduha i filteri	52
3.3	Ventili kočionog sistema	54
3.4	Ventili nivelacije kabine	59
3.5	Cilindri tristop i membranski	60
3.6	Ventili ABS, EBS i ECAS	62
3.7	Elektronika ABS i ECAS	65
3.8	Senzori	66
3.9	Cilindri kvačila	68
3.10	Pribor kočionog sistema	70
3.11	WABCO i WABCOWÜRTH dijagnostika	79

KOMPRESORI					
Poz.	Slika	KBP	Model	OE broj	RAPIDEX broj
1.		911 504 060 0	XF95	1298052	KOCN1066
2.		911 504 506 0	XF95	1736785	KOCN0606

GLAVE KOMPRESORA					
Poz.	Slika	KBP	Model	OE broj	RAPIDEX broj
1.		911 504 650 2	95ATI	513821	KOCN0740
2.		911 504 803 2	95XF	1458906	KOCN1866

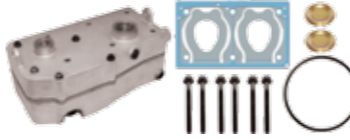
GLAVE KOMPRESORA					
Poz.	Slika	KBP	Model	OE broj	RAPIDEX broj
3.		911 504 922 2	XF95	1743267	KOCN2208
4.		912 518 920 2	XF105	1673247	KOCN2207

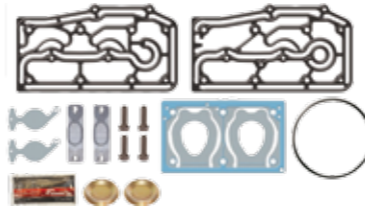
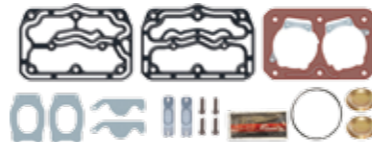
ZAPTIVAČI KOMPRESORA					
Poz.	Slika	KBP	Model	OE broj	RAPIDEX broj
1.		1600 120 100	105 XF	-	MOTO2919
2.		1600 060 100	XF 95	-	MOTO1855

ISUŠIVAČI VAZDUHA					
Poz.	Slika	KBP	Model / Opis	OE broj	RAPIDEX broj
1.		LA8130	CF75, CF85, 95XF, XF95, XF105/ 10,0 bar	1607424	KOCN1912
2.		ZB4578	CF75, CF85, 95XF, XF95, XF105/ 10,0 bar, APU jedinica	1374293	KOCN1926

FILTERI ISUŠIVAČA VAZDUHA					
Poz.	Slika	KBP	Opis	OE broj	RAPIDEX broj
1.		432 410 222 0	M39 x 1,5 mm	1518683	KOCN0894
2.		432 901 223 2	NOVI TIP M39 x 1,5 mm	1506635	KOCN0923



FILTERI ISUŠIVAČA VAZDUHA					
Poz.	Slika	KBP	Opis	OE broj	RAPIDEX broj
3.		432 901 246 2	PROTECTOR M41 x 1,5 mm	1821580	FILT0574
4.		T200W	M41 x 1,5 mm	1391510	FILT0305
5.		-	M39 x 1,5 mm	1925363	FILT1524



ČETVOROKRUŽNI / ŠESTOKRUŽNI ZAŠTITNI VENTILI

Poz.	Slika	KBP	Model / Opis	OE broj	RAPIDEX broj
1.		AE 4528	95XF	1607416	KOCN0139

VENTILI RELEJNI

Poz.	Slika	KBP	Model / Opis	OE broj	RAPIDEX broj
1.		973 011 000 0	95FA, 95FT, 95FTG	1082666	KOCN1754
2.		973 011 205 0	65CF, 75CF, 85CF, 95XF, CF75, CF85	1302103	KOCN1755



VENTILI OGRANIČENJA PRITISKA

Poz.	Slika	KBP	Model / Opis	OE broj	RAPIDEX broj
1.		475 010 400 0	SVI MODELI 8 – 10 bar	1305138	KOCN0846

VENTILI BRZOG ISPUSTA

Poz.	Slika	KBP	Model	Opis	OE broj	RAPIDEX broj
1.		973 500 000 0	-	M22 x 1,5 mm	-	KOCN1273
2.		973 500 028 0	-	M22 x 1,5 mm 23M16 VOSS	-	KOCN1141
3.		973 500 038 0	-	M 22 x 1,5 mm M16	-	KOCN0501
4.		973 500 042 0	-	M 22 x 1,5 mm VOSS	-	KOCN0702
5.		973 500 051 0	-	INTERGISAN DUPLI	-	KOCN0997

DVOSMERNI VENTILI

Poz.	Slika	KBP	Model	OE broj	RAPIDEX broj
1.		434 202 000 0	UNIVERZALNI	-	KOCN1280
2.		434 208 000 0	UNIVERZALNI	-	KOCN0590
3.		434 208 029 0	UNIVERZALNI	-	KOCN0888



PRELIVNI VENTILI



Poz.	Slika	KBP	Model	OE broj	RAPIDEX broj
1.		434 100 125 0	UNIVERZALNI	1504934	KOCN0766
2.		434 100 130 0	UNIVERZALNI	-	KOCN2472
3.		434 100 228 0	UNIVERZALNI	-	KOCN2631



VENTIL RAZVODNIK

Poz.	Slika	KBP	Model	OE broj	RAPIDEX broj
1.		463 036 000 0	UNIVERZALNI	-	KOCN1674
2.		463 036 001 0	UNIVERZALNI	-	KOCN1086



ELEKTROMAGNETNI VENTIL

Poz.	Slika	KBP	Model	OE broj	RAPIDEX broj
1.		472 172 626 0	SVI MODELI	1330025	KOCN0991
2.		472 172 606 0	SVI MODELI	1315507	KOCN0532
3.		472 172 604 0	95XF	1285545	KOCN0992

VENTILI PEDALE KOČNICE					
Poz.	Slika	KBP	Model	OE broj	RAPIDEX broj
1.		461 317 000 0	95ATI, BOVA	1506089	KOCN1752
2.		461 318 604 0	95ATI, BOVA	1524016	KOCN0948

VENTILI RUČNE PARKIRNE KOČNICE					
Poz.	Slika	KBP	Model	OE broj	RAPIDEX broj
1.		961 723 010 0	95ATI, BOVA	1518231	KOCN1733
2.		961 723 203 0	95ATI, BOVA	1518238	KOCN2187





VENTILI UPRAVLJANJA PRIKOLICE					
Poz.	Slika	KBP	Model	OE broj	RAPIDEX broj
1.		973 002 022 0	95XF	1519319	KOCN0739

VENTILI RETARDERA					
Poz.	Slika	KBP	Model	OE broj	RAPIDEX broj
1.		472 260 005 0	XF95	-	KOCN0847
2.		472 260 011 0	XF95	-	MENJ0330

AUTOMATSKI REGULATORI SILE KOČENJA					
Poz.	Slika	KBP	Model	OE broj	RAPIDEX broj
1.		475 711 126 0	CF75, CF85, 95XF	1302096	KOCN0867

VENTILI NIVELACIJE KABINE					
Poz.	Slika	KBP	Model	OE broj	RAPIDEX broj
1.		464 007 003 0	95XF	1518094	VESA0047



TRISTOP CILINDRI



Poz.	SLIKA	KBP	Model / Opis	OE broj	RAPIDEX broj
1.		925 494 041 0	85CF, 95XF 16/24	1524590	KOCN0563
2.		925 460 027 0	95XF 20/24	1522314	KOCN0304
3.		925 491 143 0	95XF 24/30	1519444	KOCN0866
4.		925 481 150 0	XF105 24/24	1686001	KOCN3460



MEMBRANE TRISTOP CILINDRA

Poz.	KBP	Tip	Prečnik x Visina	RAPIDEX broj
1.	897 120 495 4	TIP 9	Ø128 x 31 mm	KOCN1555
2.	897 120 505 4	TIP 12 P	Ø139 x 31 mm	KOCN1259
3.	897 120 510 4	TIP 16 P	Ø156 x 35 mm	OSTA3129
4.	897 120 516 4	TIP 16 D	Ø158 x 43 mm	KOCN3541
5.	897 120 520 4	TIP 20 P	Ø128 x 31 mm	KOCN0447
6.	897 120 526 4	TIP 20 D	Ø168 x 38 mm	KOCN1033
7.	897 120 530 4	TIP 24 P	Ø179 x 33 mm	OSTA3130
8.	897 120 535 4	TIP 24 S	Ø179 x 40 mm	KOCN1224
9.	897 120 536 4	TIP 24 D	Ø179 x 45 mm	KOCN3487
10.	897 120 540 4	TIP 30 P	Ø199 x 35 mm	KOCN3684
11.	897 120 546 4	TIP 30 D	Ø200 x 44 mm	KOCN3822
12.	897 121 610 4	TIP 14 P	Ø139 x 28 mm	KOCN4139
13.	897 121 923 4	TIP 12 D	Ø162 x 43 mm	KOCN0926

ABS RELEJNI VENTILI					
Poz.	Slika	KBP	Model	OE broj	RAPIDEX broj
1.		472 195 016 0	UNIVERZALNI	1505210	KOCN0551
2.		472 195 018 0	UNIVERZALNI	1504901	KOCN1164

ADAPTER KABEL ABS VENTILA					
Poz.	Slika	KBP	Model	OE broj	RAPIDEX broj
1.		894 601 132 2	UNIVERZALNI	-	KOCN1154
2.		894 601 133 2	UNIVERZALNI	-	KOCN1156
3.		894 601 134 2	UNIVERZALNI	-	KOCN0251

EBS VENTILI					
Poz.	Slika	KBP	Model / Opis	OE broj	RAPIDEX broj
1.		480 001 500 0	CF75, CF85, XF95, XF105	1395722	KOCN1632
2.		480 202 005 0	CF75, CF85, XF95, XF105	1448019	KOCN0402

EBS VENTIL - OSOVINSKI MODULATOR					
Poz.	Slika	KBP	Model / Opis	OE broj	RAPIDEX broj
1.		480 103 043 0	CF85, XF95, XF105 4x2, 6x2	1340390	KOCN0641
2.		480 103 042 0	CF85, XF95, XF105 6x2, 6x4	1315705	KOCN1719

ECAS ELEKTROMAGNETNI VENTIL					
Poz.	Slika	KBP	Model	OE broj	RAPIDEX broj
1.		472 900 012 0	95ATI	1505292	VESA0514
2.		472 900 053 0	CF75, CF85, XF95, XF105	1302682	VESA1050
3.		472 900 055 0	LF45, CF75, CF85, XF95, XF105	1304587	VESA0426
4.		472 905 111 0	LF45, CF75, CF85, XF95, XF105	1305452	VESA0612



ELEKTRONIKA ABS					
Poz.	KBP	Model	Opis	OE broj	RAPIDEX broj
1.	446 004 064 0	75ATI, 85ATI	-	1240844	KOCN2172
2.	446 004 412 0	95XF	-	1315684	KOCN2173

ELEKTRONIKA ECAS - CENTRALA					
Poz.	KBP	Model	Opis	OE broj	RAPIDEX broj
1.	446 170 219 0	XF105	6 x 2	-	VESA0200

SENZORI ABS

Poz.	KBP	Model	Opis	OE broj	RAPIDEX broj
1.	441 032 921 2	UNIVERZALNI	400 mm, SET pod uglom	1238548	KOCN1147
2.	441 032 922 2	UNIVERZALNI	1000 mm, SET pod uglom	-	KOCN1322
3.	441 032 963 2	UNIVERZALNI	350 mm, SET, ravan	1506007	KOCN0916
4.	441 032 905 0	UNIVERZALNI	350 mm, ravan	-	KOCN1652
5.	441 032 808 0	UNIVERZALNI	400 mm, pod uglom	1504951	KOCN1216

PRODUŽNI KABEL SENZORA

Poz.	KBP	Opis	RAPIDEX broj
1.	449 712 008 0	DUŽINA 800 mm	KOCN1655
2.	449 712 018 0	DUŽINA 1800 mm	KOCN0891
3.	449 712 030 0	DUŽINA 3000 mm	KOCN1107
4.	449 712 051 0	DUŽINA 5100 mm	KOCN0719
5.	449 712 060 0	DUŽINA 6000 mm	KOCN0886
6.	449 712 120 0	DUŽINA 12000 mm	KOCN0973

PREKIDAČI PRITISKA

Poz.	Slika	KBP	Opis	OE broj	RAPIDEX broj
1.		441 009 101 0	UNIVERZALNI	-	VESA0642
2.		441 014 006 0	UNIVERZALNI	-	KOCN1658
3.		441 014 010 0	UNIVERZALNI	-	VESA0488
4.		441 014 017 0	UNIVERZALNI	-	KOCN1659
5.		441 014 025 0	UNIVERZALNI	-	VESA0674



SENZOR PRITISKA

Poz.	Slika	KBP	Model / Opis	OE broj	RAPIDEX broj
1.		441 044 107 0	UNIVERZALNI 10 bar	1506009	KOCN0752



SENZORI ECAS-a

Poz.	Slika	KBP	Model	OE broj	RAPIDEX broj
1.		441 050 100 0	LF, CF, XF	1365935	KOCN0843

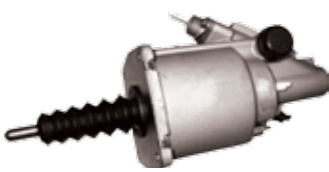

SERVO CILINDRI KVAČILA

Poz.	Slika	KBP	Model	OE broj	RAPIDEX broj
1.		970 051 126 0	95ATI	1505138	KVAC0139
2.		970 051 424 0	95ATI	1506467	KVAC0136
3.		970 051 809 0	CF85, XF95	1395608	MENJ0530
4.		628036AM	XF95, BOVA	1438606	MENJ0930

SERVO CILINDRI KVAČILA

Poz.	Slika	KBP	Model	OE broj	RAPIDEX broj
5.		629134AM	XF105	1617399	MENJ0989
6.		0 483 005 005	XF105	1447248	MENJ0760

PRIMARNI CILINDRI KVAČILA

Poz.	Slika	KBP	Model	Opis / Odlivak	OE broj	RAPIDEX broj
1.		CF75	KG 250001.0.2	Ø25,4 mm S 5171	395161	KVAC0193
2.		XF95	5.53032	Ø22,2 mm -	1348735	KVAC0061

CREVA VAZDUHA

Poz.	KBP	Opis	Dužina	Boja	RAPIDEX broj
1.	40194	SPIRALNO M16 x 1,5 mm	4,5 m	crveno	KOCN4427
2.	40195	SPIRALNO M16 x 1,5 mm	4,5 m	žuto	KOCN4428

SPOJNE GLAVE

Poz.	Slika	KBP	Opis	RAPIDEX broj
1.		452 802 007 0	DUOMATIC - BRZA, M16 x 1,5 mm	KOCN0743
2.		452 802 009 0	DUOMATIC - BRZA sa ABE, M16 x 1,5 mm	KOCN1044

SPOJNE GLAVE

Poz.	Slika	KBP	Opis	RAPIDEX broj
3.		452 803 005 0	DUOMATIC - BRZA, PRIKLJUČAK ABE, M16 x 1,5 mm	KOCN0521
4.		452 804 012 0	DUOMATIC - BRZA, VUČNO VOZILO, M16 x 1,5 mm	KOCN1043
5.		452 805 004 0	DUOMATIC - BRZA, M16 x 1,5 mm	KOCN0520
6.		952 200 021 0	M16 mm, CRVENA, PRIKOLICA	KOCN1345
7.		952 200 022 0	M16 mm, ŽUTA, PRIKOLICA	KOCN1346
8.		952 200 221 0	M16 mm, CRVENA, KAMION	KOCN1347

SPOJNE GLAVE				
Poz.	Slika	KBP	Opis	RAPIDEX broj
9.		952 200 222 0	M16 mm, ŽUTA, KAMION	KOCN1357
10.		952 201 001 0	SA FILTEROM, M16 mm, ŽUTA, max 8,5 bar	KOCN0827
11.		952 201 002 0	SA FILTEROM, M16 mm, CRVENA, max 8,5 bar	KOCN0826
12.		06550	GUMICA SPOJNE GLAVE	KOCN3532



CREVA VAZDUŠNE INSTALACIJE				
Poz.	Opis	Dužina	KBP	RAPIDEX broj
1.	4 x 1,0 mm	25 m	02506	KOCN3581
2.	5 x 1,0 mm	25 m	T 7300.27	KOCN0885
3.	6 x 1,0 mm	25 m	07722	KOCN3631
4.	8 x 1,0 mm	25 m	07723	KOCN3542
5.	9 x 1,5 mm	25 m	02507	OSTA3475
6.	10 x 1,0 mm	25 m	07725	KOCN4093
7.	12 x 1,5 mm	25 m	07726	KOCN3802
8.	15 x 1,5 mm	25 m	07727	KOCN4179
9.	18 x 2,0 mm	25 m	T 7300.20	KOCN1069
10.	NW 11 x 3,5 mm	40 m	01144	KOCN3777
11.	NW 13 x 6,0 mm	40 m	01145	KOCN3740
12.	NW 15 x 5,0 mm	40 m	T 7299.96	KOCN0902



SPOJNICE CREVA			
Poz.	KBP	Opis	RAPIDEX broj
1.	893 129 401 2	CREVO 11 x 3,5 mm, M16 x 1,5 mm	OSTA0257
2.	893 129 402 2	CREVO 11 x 3,5 mm, M22 x 1,5 mm	OSTA0256
3.	893 129 403 2	CREVO 13 x 6 mm, M16 x 1,5 mm	OSTA0255
4.	893 129 404 2	CREVO 13 x 6 mm, M22 x 1,5 mm	OSTA0254
5.	893 226 682 2	UTIČNICA VOSS NG8 WABCO	OPRE0209
6.	893 226 689 2	ADAPTER M16 VOSS SA 232 NA 230	OPRE0021
7.	893 226 690 2	ADAPTER M22 VOSS SA 232 NA 230	OPRE0022
8.	893 800 005 2	CREVO 8 x 1 mm, M22 x 1,5 R mm	OSTA0176
9.	893 800 009 2	CREVO 10 x 1 mm, M16 x 1,5 mm	OSTA2213
10.	893 803 890 0	CREVO10 x 1 mm, M22 x 1,5 mm	OSTA1249
11.	893 800 002 2	CREVO 12 x 1,5 mm, M16 x 1,5 mm	OSTA0476
12.	893 800 008 2	CREVO 12 x 1,5 mm, M22 x 1,5 mm	OSTA0485
13.	893 800 004 2	CREVO 15 x 1,5 mm, M22 x 1,5 mm	OSTA1087
14.	893 800 007 2	CREVO 8 x 1 mm, M12 x 1,5 mm	OSTA0483
15.	893 800 001 2	CREVO 8 x 1 mm, M16 x 1,5 mm	OSTA0482

SPOJNICE CREVA			
Poz.	KBP	Opis	RAPIDEX broj
16.	893 803 022 0	CREVO 6 x 1 mm, M12 x 1,5 mm	OSTA1170
17.	893 800 003 2	CREVO 16 x 2 mm, M22 x 1,5 mm	OSTA0484
18.	893 803 035 0	CREVO 6 x 2 mm, M10 x 1,5 mm	OSTA1171
19.	893 803 780 0	CREVO 15 x 2 mm, M22 x 1,5 mm	OSTA0262
20.	893 831 223 0	CREVO 6 x 1 mm, M12 x 1,5 mm, pod uglom	OSTA0477
21.	893 831 291 0	CREVO 8 x 1 mm, M12 x 1,5 mm, pod uglom	OSTA1570
22.	893 831 293 0	CREVO 8 x 1 mm, M16 x 1,5 mm, pod uglom	OSTA1136
23.	893 831 292 0	CREVO 8 x 1 mm, M22 x 1,5 mm, pod uglom	OSTA0480
24.	893 831 295 0	CREVO 12 x 1,5 mm, M16 x 1,5 mm, pod uglom	OSTA1764
25.	893 831 215 0	CREVO 15 x 1,5 mm, M16 x 1,5 mm, pod uglom	OSTA1901



KUTIJA SA SPOJNICAMA	
KBP	RAPIDEX broj
893 000 200 0	OSTA1115



SPOJNICE CREVA				
Slika	Poz.	Opis	KBP	RAPIDEX broj
	1.	4 mm	T 7820.00	KOCN1102
	2.	5 mm	T 7820.01	KOCN1101
	3.	6 mm	T 7820.02	KOCN1100
	4.	8 mm	T 7820.03	KOCN1099
	5.	10 mm	T 7820.04	KOCN1098
	6.	12 mm	T 7820.05	KOCN1097
	7.	15 mm	T 7820.06	KOCN1096
	8.	22 mm	T 7820.08	KOCN1095
	9.	4 mm	T 7830.00	KOCN1029
	10.	5 mm	T 7830.01	KOCN1710
	11.	6 mm	T 7830.02	KOCN1028
	12.	8 mm	T 7830.03	KOCN1027
	13.	10 mm	T 7830.04	KOCN1026
	14.	12 mm	T 7830.05	KOCN1025
	15.	15 mm	T 7830.06	KOCN1709
	16.	4 mm	T 7840.00	KOCN1022
	17.	5 mm	T 7840.01	KOCN1713
	18.	6 mm	T 7840.02	KOCN1021
	19.	8 mm	T 7840.03	KOCN1020
	20.	10 mm	T 7840.04	KOCN1019
	21.	12 mm	T 7840.05	KOCN1018
	22.	15 mm	T 7840.06	KOCN1714

ALAT ZA BRZE SPOJNICE					
Poz.	Slika	KBP	Opis	OE broj	RAPIDEX broj
1.		899 700 001 4	8 x 1,5 mm	-	OSTA0716
2.		899 700 002 4	12 x 1,5 mm	-	OSTA0717
3.		899 700 003 4	15 x 1,5 / 16 x 2	-	OSTA0718

PRIGUŠIVAČI ZVUKA					
Poz.	Slika	KBP	Opis	OE broj	RAPIDEX broj
1.		432 407 012 0	Ø87 x 62 mm	UNIVERZALNI	KOCN0746
2.		432 407 060 0	Ø69 x 56,5 mm	UNIVERZALNI	KOCN0858
3.		432 407 070 0	Ø69 x 53 mm	UNIVERZALNI	KOCN0859

RAPIDEX

TRADE



3

TEČNOST PROTIV SMRZAVANJA INSTALACIJA

Poz.	KBP	Opis	RAPIDEX broj
1.	830 702 087 4	WABCOTIL 1/1	ULJA0042
2.	830 702 090 4	WABCOTIL 200/1	ULJA0043

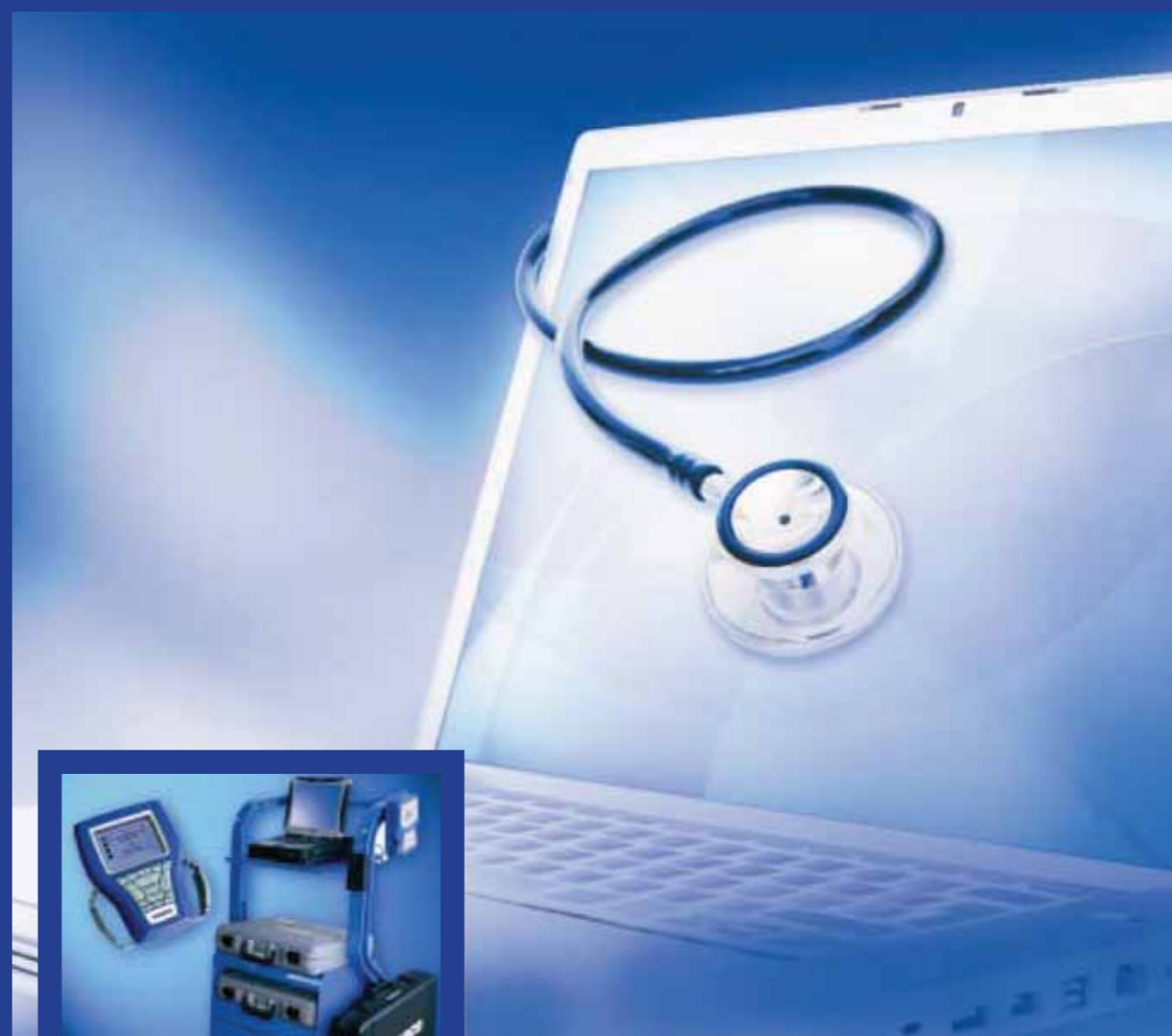

DIJAGNOSTIKA
Hardver & Softver

WABCO

Dok je ranijih godina za dijagnostiku svakog sistema na komercijalnim vozilima bio potreban poseban dijagnostički uređaj, danas je dovoljno posedovati JEDAN da bi se uspešno rešavali problemi kako različitih SITEMA tako i različitih proizvođača VOZILA

WABCO u svojoj ponudi raspolaže sa DVA RAZLIČITA dijagnostička sistema:

- WABCO SD sistem - WABCO SISTEMSKA DIJAGNOSTIKA
- WABCO & WÜRTH sistem.

Za svaku od ovih sistema nudimo neophodnu OPREMU, PROGRAME i što je velika retkost OBUKU.



WABCO & WÜRTH - DIJAGNOSTIČKI SISTEM

Ovaj DIJAGNOSTIČKI UREĐAJ predstavlja najsavremeniju UNIVERZALNU DIJAGNOSTIČKU ALATKU na tržištu sa nebrojeno mnogo funkcija i mogućnosti kako za rad, tako i za PERSONALIZACIJU - prema potrebama samog korisnika.

Sam sistem se može dobiti u dve osnovne varijante:

- SA SD WABCO DIJAGNOSTIKOM
- BEZ SD WABCO DIJAGNOSTIKE

Dalje je moguća podela po delokrugu rada na:

- KOMPLETAN PAKET (SISTEMI KAMIONA, PRIKOLICE I BUS-a, LAKI TERETNI PROGRAM)
- KAMIONSKI PAKET
- PRIKOLIČNI PAKET
- BUS PAKET



WABCO & WÜRTH - DIJAGNOSTIČKI SISTEM

Sistemi na vozilima koji se mogu kontrolisati sa ovim uređajima su:

- KOČIONI SISTEM
- MENJAČ
- MOTOR
- ELEKTRIČNE INSTALACIJE
- GREJANJE I HLAĐENJE
- UPRAVLJANJE I VEŠANJE



Zbog stalnog usavršavanja i dopunjavanja teško je definisati krajnje mogućnosti rada ovog uređaja te zbog toga  omogućava proveru mogućnosti uređaja - PREZENTACIJU SVAKOM ZAINTERESOVANOM KLIJENTU kod njega na vozilima koja klijent odabere.

SVI ZAINTERESOVANI MOGU ZAKAZATI BESPLATNU PREZENTACIJU PREKO FIRME „RAPIDEX TRADE“ TE ĆE STRUČNI LJUDI  UBRZO STUPITI U KONTAKT SA ZAINTERESOVANIMA.

Više informacija se može dobiti na: <http://www.wabcowuerth.com>



WABCO **SD - SISTEMSKA DIJAGNOSTIKA**

Za SD dijagnostiku WABCO sistema koristi se sledeća oprema:

- KOFER ZA PROVERU PNEUMATSKE KOČIONE INSTALACIJE
- KOFERI SA DIJAGNOSTIČKOM OPREMOM
- PAKETI DIJAGNOSTIČKIH PROGRAMA

WABCO SD - OPREMA

• **Kofer za dijagnostiku pneumatske kočione instalacije**



W: 435 002 007 0
R: KOCN1763

• **Kofer za dijagnostiku prikoličnih sistema** **W: 446 301 023 0** **R: KOCN0837**

Sadržaj kofera za dijagnostiku sistema na prikolicama i poluprikolicama:

- Diagnostic Interface
- Trailer Standardkabel
- CAN Adapter
- CAN Adapterkabel
- VCS I
- VCS II
- TEBS C / D



• **Kofer za dijagnostiku sistema na kamionima** **W: 446 301 025 0** **R: KOCN1764**

Sadržaj kofera za dijagnostiku sistema na kamionima:

- Adapter 35-pol EPS
- Kabel MB Actros/Citaro
- Kabel EBS Euro Neoplan
- Kabel MAN-TGA
- Kabel EBS IVECO Stralis
- Kabel ABS-D
- Kabel EBS DAF
- Kabel Actros MPII (OBD II)
- Kabel ECAS
- Kabel 15-pol. DAF, Scania, MAN (OBD II)
- Kabel ABS D/E ISO 9141



• **Kofer za dijagnostiku sistema na autobusima** **W: 446 301 026 0** **R: KOCN1765**

Sadržaj kofera za dijagnostiku sistema na autobusima:

- Diagnostic Interface
- Kabel MB Actros/Citaro
- Kabel EBS Euro Neoplan
- Kabel MAN-TGA
- Kabel Setra NF 315 MTS
- Kabel Actros MPII (OBD II)
- Kabel 15-pol. DAF, Scania, MAN (OBD II)



• **Paketi dijagnostičkih programa:**

- PAKET FULL (KAMIONI, AUTOBUSI, PRIKOLICE) **W: 246 301 900 0**
R: OPRE0098
- PAKET PRIKOLICA - POLUPRIKOLICA **W: 246 301 901 0**
R: OPRE0524
- PAKET AUTOBUSI **W: 246 301 902 0**
R: OPRE0525
- PAKET KAMIONI **W: 246 301 904 0**
R: OPRE0526



RAPIDEX TRADE svake godine u saradnji sa WABCO-m organizuje **OBUKU - TRENING** za servisere WABCO sistema.

Obuka se odvija u **EDUKATIVNOM CENTRU** u Novom Sadu, Novosadski put 160.

Do sada je obuku uspešno završilo nekoliko generacija polaznika, koje se uspešno nose sa svakodnevnim problemima kvarova na vozilima širom Srbije i zemalja u okruženju.

Predavač WABCO TRENER gospodin Berislav Babić



Detalji sa obuke u edukativnom centru



- **PROIZVODI i REŠENJA** za komercijalna vozila
- **PRIMENA** za proizvodnju vozila
- **ORIGINALNI KVALITET** za Popravku

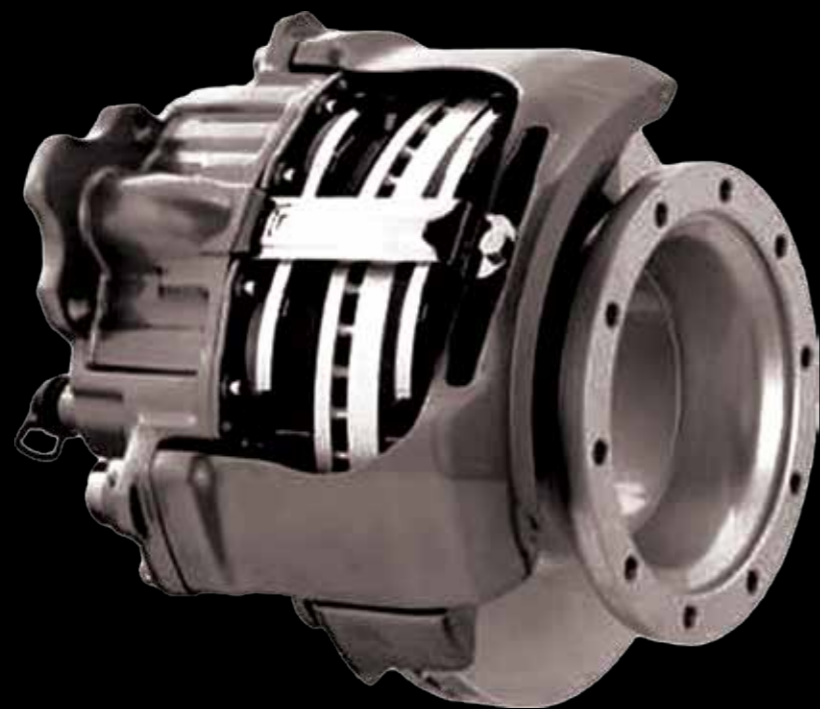

4.0 KOMPONENTE KOČIONOG SISTEMA



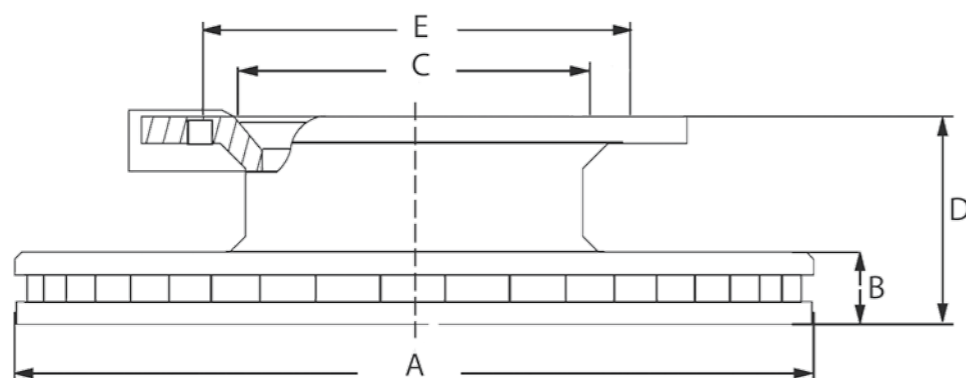

4.0 KOMPONENTE KOČIONOG SISTEMA

4.1	Disk kočnica	88
4.2	Kočione pločice	90
4.3	Čeljusti kočnica	91
4.4	Doboši kočnica	92
4.5	Kočione obloge	93
4.6	Šteleri kočnica	94
4.7	Glavčine točka, ležajevi i semerinzi	96
4.8	Vijci i navrtke	99

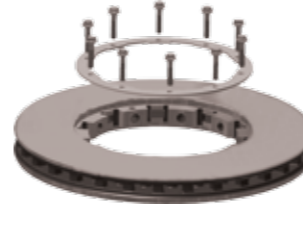

DISK KOČNICA								
	Poz.	Model vozila	OE broj		RAPIDEX broj			
	1.	LF 45/55	1400163		KOCN2269			
	A (mm)	Bmin (mm)	Bmax (mm)	C (mm)	D (mm)	E (mm)	Rupe	Pozicija
329	31	34	117	123	138	12 x M12 x 1,75 mm	Pr	
	Poz.	Model vozila	OE broj		RAPIDEX broj			
	2.	LF 45/55	1400273		KOCN2085			
	A (mm)	Bmin (mm)	Bmax (mm)	C (mm)	D (mm)	E (mm)	Rupe	Pozicija
330	31	34	150	119	175	12 x M12 x 1,75 mm	Zd	

DISK KOČNICA								
	Poz.	Model vozila	OE broj		RAPIDEX broj			
	3.	CF 55-85, XF 95, XF105, Berkohof	1640561		OSOV0026			
	A (mm)	Bmin (mm)	Bmax (mm)	C (mm)	D (mm)	E (mm)	Rupe	Pozicija
432	37	45	258	45	-	-	Pr/Zd	
	Poz.	Model vozila	OE broj		RAPIDEX broj			
	4.	BUS	1142086		KOCN1435			
	A (mm)	Bmin (mm)	Bmax (mm)	C (mm)	D (mm)	E (mm)	Rupe	Pozicija
377	37	45	117	112	144	10	Pr	
	Poz.	Model vozila	OE broj		RAPIDEX broj			
	5.	BUS	1142132		KOCN3576			
	A (mm)	Bmin (mm)	Bmax (mm)	C (mm)	D (mm)	E (mm)	Rupe	Pozicija
377	38	45	169	138,5	196	8	Zd	

KOČIONE PLOČICE						
	WVA broj		Dimenzije (mm)			RAPIDEX broj
	29088	Wabco	175,6	82,5	26	KOCN0909
	Poz.	Model vozila		OE broj		
1.	LF45/55		1436901			
	WVA broj		Dimenzije (mm)			RAPIDEX broj
	29159	Wabco	210,5	92,3	29,8	KOCN1456
	Poz.	Model vozila		OE broj		
1.	LF 45/55		1628064			
	WVA broj		Dimenzije (mm)			RAPIDEX broj
	29202	Knorr	247,3	109,5	30	KOCN0875
	Poz.	Model vozila		OE broj		
1.	XF95, XF105, CF 75, 85		1640561			

SENZORI ISTROŠENOSTI PLOČICA					
Slika	Poz.	Model vozila	Dimenzije	OE broj	RAPIDEX broj
	1.	CF65, CF75, CF85	290 mm	1335421	KOCN0327



ČELJUSTI						
Poz.	Model vozila	Tip čeljusti	Proizvođač	KBP	OE broj	RAPIDEX broj
1.	LF45-55	PAN 17	WABCO	40 175 072	1440500	KOCN1382
2.	LF 45-55	PAN 17	WABCO	40 175 073	1440501	KOCN1381
3.	CF55-85, XF95	PAN 19-1 PLUS	WABCO	40 195 038	877931	KOCN1320
4.	CF55-85, XF95	PAN 19-1 PLUS	WABCO	40 195 037	877930	KOCN1119
5.	CF85, XF95	22,5	KNORR	SN7168/K003806	1627246	KOCN1397
6.	CF85, XF 95	22,5	KNORR	SN7178/K003805	1627247	KOCN1396
7.	XF95	PAN 22-1	WABCO	40 225 015	877933	KOCN0779
8.	XF 95	PAN 22-1	WABCO	40 225 016	877934	KOCN0778
9.	XF95, 105	22,5	KNORR	SN7167/K003808	1658010	KOCN1398
10.	XF95. 105	22,5	KNORR	SN7177/K00307	1658011	KOCN3404

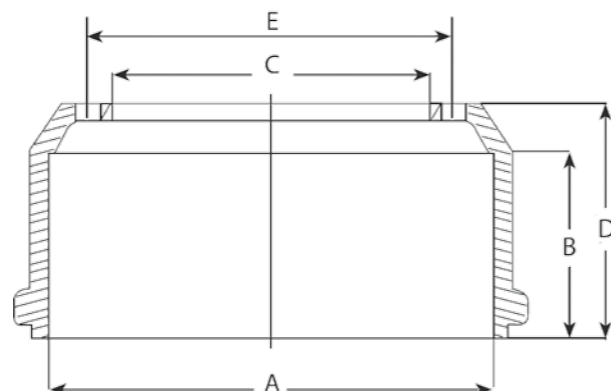

DOBOŠI KOČNICA

Poz.	Model	A (mm)	B (mm)	C (mm)	D (mm)	E (mm)	Rupe	Pozicija	OE broj	RAPIDEX broj
1.	ATI 95, XF95 310-400, serija 65, 75, 95 87- CF75, CF85 96-	420	216	285	268	335	10 x Ø24 mm, 2 x Ø14 mm, 2 x M12 x 1,75 mm	Zd	186829 754397	KOCN1412
2.	ATI95, XF95 310-400 serija 65-85, CF65-85	420	168	285	228	335	10 x Ø24 mm, 2 x Ø14 mm, Ø30mm & 2 x M12 x 1,75 mm	Pr/Zd	1233462	KOCN1221
3.	ATI95 310-400, serija 65-95 89-	420	214	285	286	335	10 x Ø24mm, 2 x Ø14mm, Ø30mm & 2 x M12 x 1,75 mm	Zd	1365579	KOCN0427

CF65, CF75, CF85, XF95

WVA broj	Ø mm				OE broj	RAPIDEX broj
19010	420	150	181	8	683274	
19010 2080						KOCN1549
19010 2180						KOCN1550
Model vozila						
CF65, CF75, CF85, XF95						

CF65, CF75, CF85, ATI95, XF95





WVA broj	Ø mm				OE broj	RAPIDEX broj
19063	420	200	180	16	356501	
19063 2070						KOCN1577
19063 2170						KOCN1578
Model vozila						
CF65, CF75, CF85, ATI95, XF95						



CF65, CF75, CF85, ATI95, XF95

WVA broj	Ø mm				OE broj	RAPIDEX broj
19900	420	150	177	8	682845	
19900 1910						KOCN1582
19900 2010						KOCN1583
Model vozila						
CF65, CF75, CF85, ATI95, XF95						

NITNE ZA OBLOGE

Model vozila	Dimenzije	Set	KBP	RAPIDEX broj
SVI MODELI	Ø6,53 x 17,65 mm	100 kom	96000 0071	KOCN2447

ŠTELERI KOČNICA							
Slika	Poz.	Model vozila	Broj zuba	Oso rastojanje (mm)	Haldex broj	OE broj	RAPIDEX broj
	1.	CF65, CF75, CF85, 95XF	10	140	72523C	278350	KOCN1457
	2.	CF65, CF75, CF85, 95XF	10	140	72524C	278351	KOCN1458
	3.	CF75, CF85, 95XF	10	165	72538C	361544	KOCN1459
	4.	CF75, CF85, 95XF	10	165	72539C	361543	KOCN1460
	5.	CF65, CF75, CF85, 95XF	10	165	72542C	361541	KOCN1461

ŠTELERI KOČNICA							
Slika	Poz.	Model vozila	Broj zuba	Oso rastojanje (mm)	Haldex broj	OE broj	RAPIDEX broj
	6.	CF65, CF75, CF85, 95XF	10	165	72543C	361542	KOCN1462
	7.	XF95	26	145	79205C	-	KOCN0516
	8.	XF95	26	145	79206C	-	KOCN3410



GLAVČINE TOČKA

Poz.	Model vozila	OE broj	RAPIDEX broj
1.	CF85, XF95, BUS BERKHOF	1391617	KOCN0098
2.	CF85, XF95, BUS BERKHOF	1391615	OSOV0267
3.	CF75,CF85, 95XF, BUS	1348432	OSOV0266
4.	XF95	0538444 1355063	OSOV0269
5.	XF95	0224363 1245169	OSOV0268

LEŽAJEVI

Poz.	Model vozila	Dimenzije (mm)			KBP	OE broj	RAPIDEX broj
1.	LF 45/55	95	55	29	20108	1400081	OSOV0972
2.	LF45/55	110	66,68	22	201079	1404691	OSOV0973
3.	CF75, CF85, XF95	160	105	43	33021 VKHB2162	266488	OSOV0415
4.	CF75, CF85. BUS	100	45	38,25	32309 VKHB2004	283686	OSOV0416
5.	CF 75, CF85, XF95	140	80	46	33216	556290	OSOV0417
6.	CF65, CF85, XF95	130	70	58	528983B	260204	OSOV0418
7.	CF75, CF85, 95XF	110	50	42,25	32310A VKHB2070	626875	OSOV0219
8.	CF75, CF85, XF95	120	55	45,5	32311A	272828	OSOV0420
9.	CF75, CF85, XF95	145	95	39	33019 VKHB2082	676987	OSOV0717
10.	XF105	148	93,8	135	VKBA5423	1075408	OSOV0604
11.	CF85. XF95, XF105	124,7	70	110,03	566834.H195	1801595	OSOV0697
12.	XF95, XF105	148	100	135	566283.H195	1801594	OSOV0870



SEMERINZI

Poz.	Model vozila	Dimenzije (mm)			OE broj	RAPIDEX broj
1.	LF45/55	82	105	12	1400080	OSOV0882
2.	LF45/55	90	130	17	1404690	OSOV0974
3.	CF65, CF85, XF95	125	160	15,5/20	292766	OSOV0808
4.	CF65, CF75, CF85, 95XF, 95XF	100	140/166	16/22	1334961	OSOV0441
5.	CF65, CF75, CF85, 95XF, XF95	100	140	15,5/20	1278420	OSOV0442
6.	CF75, CF85, 95XF	100	140	15/20,5	1238034	OSOV0439
7.	CF85, XF95	85	140	13/17	1287102	OSOV0704
8.	CF65, CF78, CF85 XF95, XF105	125	160/190	18/20	1335063	OSOV0889
9.	CF85, XF95, XF105	105	130	12/9,5	734319551	MENJ0281
10.	CF85, XF95, XF105	105	125	12	734319459	MENJ0596

VIJCI I NAVRTKE

Poz.	Model vozila	Naziv	Dimenzije (mm)			Navoj (mm)	OE broj	RAPIDEX broj
1.	CF, XF95	VIJAK	95	85	42	M22 x 1,5	620647	OSOV0330
		NAVRTKA				M22 x 1,5	0652575	OSOV0334
2.	CF85, XF95	VIJAK	83	72	47	M22 x 1,5	1337020	OSOV0330
		NAVRTKA				M22 x 1,5	0652575	OSOV0334
3.	CF85, CF95	VIJAK	104	94	45	M22 x 1,5	1356736	OSOV0222
		NAVRTKA				M22 x 1,5	0652575	OSOV0334

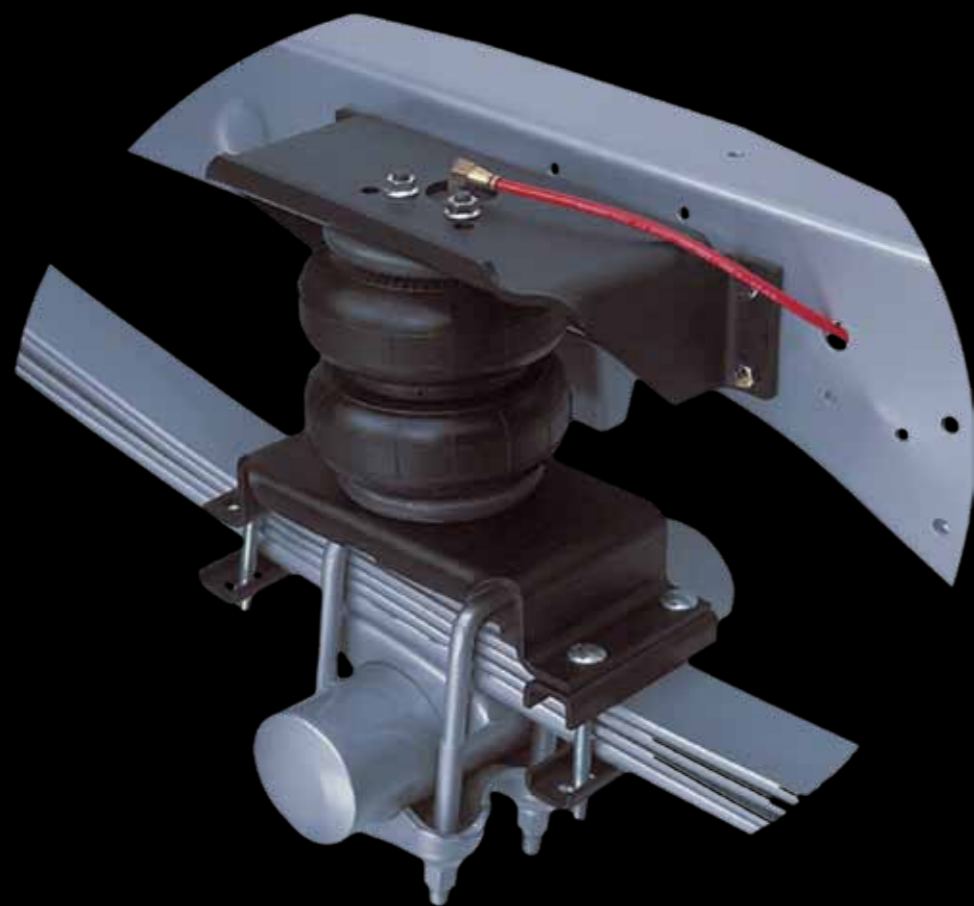
5.0 ELEMENTI OGIBLJENJA I UPRAVLJANJA



5.0 ELEMENTI OGIBLJENJA I UPRAVLJANJA

5.1	Amortizeri	102
5.2	Vazdušni jastuci	105
5.3	Gibnjevi	108
5.4	Delovi stabilizatora	109
5.5	Delovi rukavca	110
5.6	Spone i delovi spona	111
5.7	Uporne spone	114
5.8	V spone	115

AMORTIZERI - TIPOVI VEZA

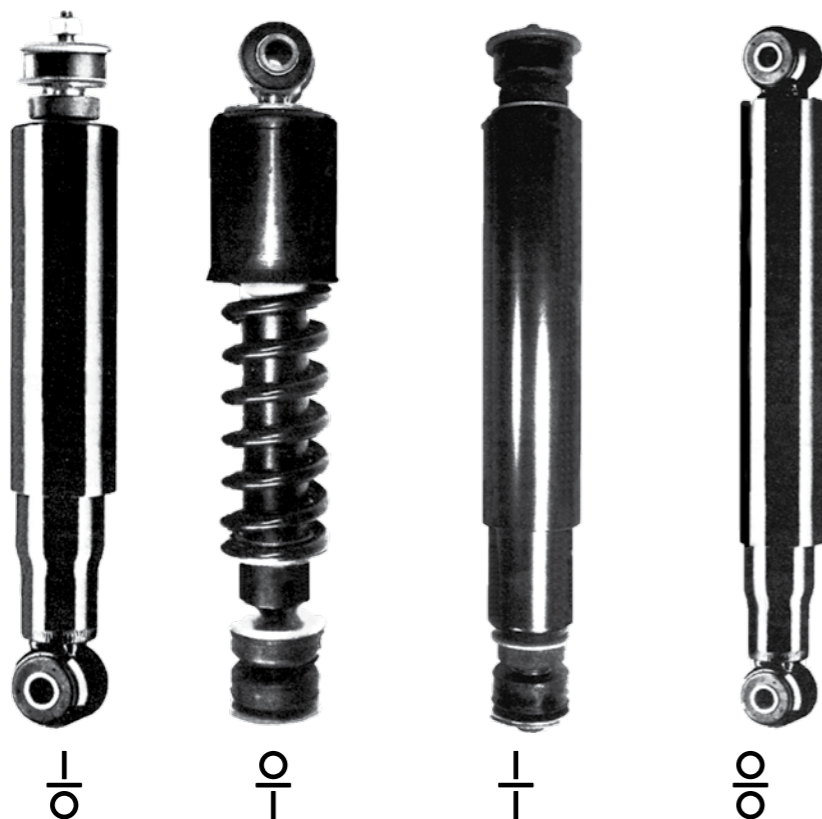

LEGENDA:

SIMBOL	ZNAČENJE	SIMBOL	ZNAČENJE
	VEZA OKO - OKO		AMORTIZER PREDNJE OSOVINE
	VEZA OKO - VIJAK		AMORTIZER ZADNJE OSOVINE
	VEZA VIJAK - OKO		PREDNJA I ZADNJA OSOVINA
	VEZA VIJAK - VIJAK		AMORTIZER KABINE - PREDNJI
	VEZA OKO - VILJUŠKA		AMORTIZER KABINE - ZADNJI
	AMORTIZER VOLANA		AMORTIZER KABINE



AMORTIZERI

Poz.	Model vozila	Osovina	Tip veze	OE broj	Sachs broj	RAPIDEX broj
1.	LF45			AFRE002	300 026	AMOR0272
2.	LF45			AFRE008	311 500	AMOR0273
3.	LF55, 65, 65CF, CF65, 75, 75CF, CF75, 85, 85CF, CF85, 95, 95XF, XF95			1443695	290 981	AMOR0277
4.	65CF, 75, 75CF, 85, 85CF, 95, 95XF			1282623	124 874	AMOR0474
5.	65CF, 75CF, CF75, 85CF, CF85, 95, 95XF			1610800	311 504	AMOR0402
6.	95, 95XF			1283723	106 976	AMOR0475
7.	95XF, XF95, XF105			1398694	290 980	AMOR0041
8.	XF105			1649947	-	AMOR0040
9.	NEOPLAN N113, 116, 121, 210, 214, 418			1002.103.00	101 424	AMOR0253
10.	NEOPLAN N113, 116, 121, 210, 214, 418			1002.102.00	101 425	AMOR0200
11.	BUS SB120			1141380	-	AMOR0623
12.	BUS SB120			1141379	-	AMOR0624



AMORTIZERI - KABINE

Poz.	Model vozila	Mesto ugradnje	Tip veze	Monroe broj	OE broj	RAPIDEX broj
1.	LF45, LF55			CB0123	1407080	AMOR0487
2.	LF45, LF55			CB0132	1407083	AMOR0590
3.	LF45, LF55			CB0126	1407082	AMOR0734
4.	95XF 380-530, XF95			CB0042	1303516	AMOR0019
5.	95, 95XF, XF95, XF105			CBO033	1265281	KABI0082
6.	95XF 97/01→02/09, XF95 02/09→XF105 06/01→			CB0044	1319672	AMOR0020
7.	95, 95XF, XF95, XF105			CB0034	1353451	AMOR0258
8.	CF65, CF75, CF85, 95			CB0012	1377827	AMOR0442
9.	95XF, XF95, XF105			CB0049	1319673	AMOR0562

GASNI AMORTIZERI

Poz.	Model vozila	Dužina L (mm)	Sila F (N)	SE-M broj	OE broj	RAPIDEX broj
1.	95, 95XF, XF95	530	400	8384	1238280	AMOR0145





701N

	Broj proizvođača dela	OE broj	Primena / Opis	RAPIDEX broj
	Contitech 701N	B 510040	BOVA	VESA1616
	Fabio 34701			

836M

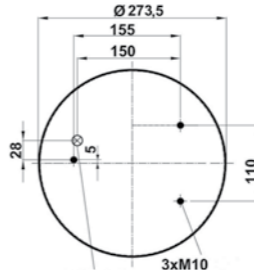
	Broj proizvođača dela	OE broj	Primena / Opis	RAPIDEX broj
	Contitech 836M	0067504	95XF, XF95, XF105	VESA1930
	Fabio 34836-S			



836MB

	Broj proizvođača dela	OE broj	Primena / Opis	RAPIDEX broj
	Contitech 836MB	0513985	95XF, XF95, XF105	VESA1975
	Fabio 34836-1S			

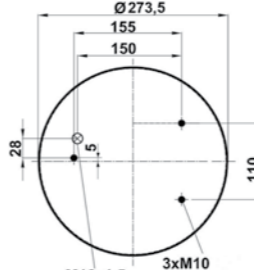

836MK1				
	Broj proizvođača dela	OE broj	Primena / Opis	RAPIDEX broj
	Contitech 836MK1	0388165	95XF, XF95, XF105	VESA2342
	Fabio 34836-1CPL			

836M2K1				
	Broj proizvođača dela	OE broj	Primena / Opis	RAPIDEX broj
	Contitech 836M2K1	0388167	95XF, XF95, XF105	VESA2664
	Fabio 34836-2CPL			

887M				
	Broj proizvođača dela	OE broj	Primena / Opis	RAPIDEX broj
	Contitech 887M	0513983	75CF, 85CF, 95XF	VESA1752
	Fabio 34887-S			

887MBK6				
	Broj proizvođača dela	OE broj	Primena / Opis	RAPIDEX broj
	Contitech 887MBK6	1141525	75CF, 85CF, 95XF	VESA2254
	Fabio 34887-1C			

887NP06				
	Broj proizvođača dela	OE broj	Primena / Opis	RAPIDEX broj
	Contitech 887NP06	1794428	75CF, 85CF, 95XF	VESA3015
	Fabio 34887-10C			



65CF, 75CF, 85CF, 95XF, XF95 (prednja osovina)							
Poz.	Model vozila	Opterećenje (t)	Širina (mm)	Broj listova x debljina lista (mm)	Dužina Lx/Ly (mm)	OE broj	RAPIDEX broj
1.	65CF, 75CF, 85CF, 95XF	6,5	80	2 x 32 1 x 23	900/900	1279672	VESA0278
2.	65CF, 75CF, 85CF, 95XF, XF95	7,1	80	1 x 28 1 x 30	900/900	1381683	VESA0279

ČAURE

Slika	Poz.	Model vozila	Dimenzije d x D x h (mm)	SE-M broj	OE broj	RAPIDEX broj
	1.	65CF, 75CF, 85CF, 95XF, XF95	24 / 62,5 / 86	8755	1357764	VESA1020
	2.	CF75, CF85	24,2 / 62,7 / 106	8756	1368283	VESA2686

DELOVI STABILIZATORA							
Slika	Pozicija	Model vozila	Mesto ugradnje	Dimenzije d x D x h (mm)	SE-M broj	OE broj	RAPIDEX broj
	1.	95XF	ZO	64 x 85 x 60	7687	0366351	KABI1246
	2.	75CF, 85CF, 95XF, CF75, CF85	ZO	20 x 60 x 6	9049	1283618	VESA2400
	3.	75CF, 85CF, 95XF, CF75, CF85	ZO	-	9156	1283618S1	VESA2401



DELOVI RUKAVACA				
Slika	Poz.	Model vozila	OE broj	RAPIDEX broj
	1.	F65, 75, 85, 95, CF65, 75, 85, 95XF, XF95	681706	OSO0282
	2.	CF65, 75, 85, XF95, XF105	683499	OSO0656

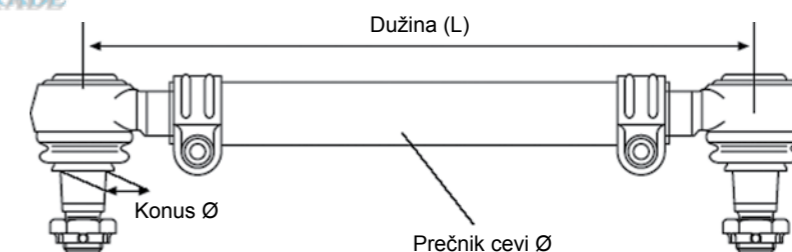

SPONE				
Poz.	Model vozila	Opis	OE broj	RAPIDEX broj
1.	BERKOF	Dužina: 1197 (mm) Ø Cevi: 40 (mm) Ø Konusa: 30 (mm)	1143324	VESA2129
2.	LF45	Dužina: 900 (mm) Ø Cevi: 38 (mm) Ø Konusa: 19,3/22 (mm)	1700913	VESA0288
3.	XF95, XF105	Dužina: 991 (mm) Ø Cevi: 50 (mm) Ø Konusa: 30 (mm)	1395994	VESA1708
4.	95XF	Dužina: 1005 (mm) Ø Cevi: 52 (mm) Ø Konusa: 26 (mm)	071990	VESA0859

SPONE				
Poz.	Model vozila	Opis	OE broj	RAPIDEX broj
5.	LF45	Dužina: 1640 (mm) Ø Cevi: 40 (mm) Ø Konusa: 26 (mm)	1407963	VESA2013
6.	75CF, 85CF, 95XF, F95	Dužina: 1615 (mm) Ø Cevi: 52 (mm) Ø Konusa: 26 (mm)	1353396 1286343	VESA2074
7.	65CF, 75CF, 85CF, 95XF	Dužina: 1698 (mm) Ø Cevi: 40 (mm) Ø Konusa: 26 (mm)	1353391 1270853	VESA2159

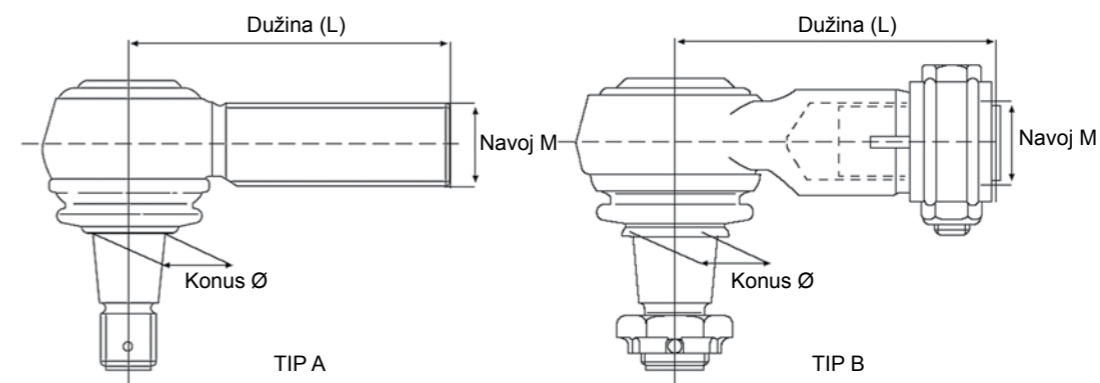

DELOVI SPONA							
Poz.	Model vozila	Dužina L (mm)	Konus Ø (mm)	Navoj M (mm)	Tip A/B	OE broj	RAPIDEX broj
1.	65CF, 75CF, 85CF	55	-	M12 x 1,75 ♂	B	1249088	VESA2887
2.	65CF, 75CF, 85CF	55	-	M12 x 1,75 ♀	B	1249129	VESA2886
3.	65CF, 75CF, 85CF	85	10,8	M14 x 1,5 ♂	B	0386930	VESA2907
4.	LF45, 65CF, 75CF, 85CF, CF65, CF75, CF85, 95XF	115	26	M30 x 1,5 ♂	A	1319838	VESA2885
5.	LF45, 65CF, 75CF, 85CF, CF65, CF75, CF85, 95XF	115	26	M30 x 1,5 ♀	A	1326896	VESA2884
6.	CF65, CF75, CF85, XF95, XF105	120	30	M30 x 1,5 ♂	A	1228115	VESA2023
7.	CF65, CF75, CF85, XF95, XF105	120	30	M30 x 1,5 ♀	A	1257890	VESA2022

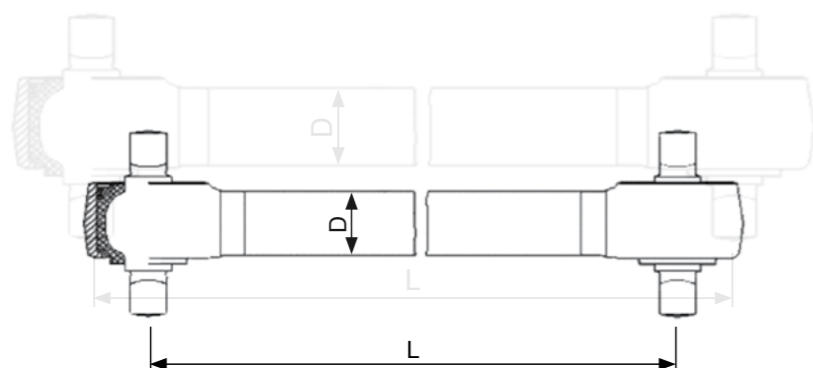
UPORNE SPONE

Poz.	Model vozila	L (mm)	D (mm)	Reparatur set	Lemförder broj	OE broj	RAPIDEX broj
1.	85, 95, 95XF, XF95	605	48	-	22317 02	1361649	VESA0995

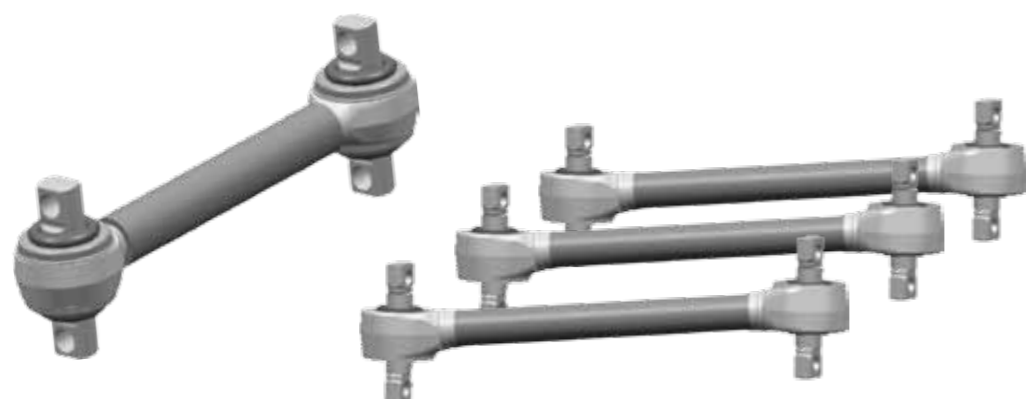
V SPONE

Poz.	Model vozila	L (mm)	D (mm)	Reparatur set	Lemförder broj	OE broj	RAPIDEX broj
1.	95XF, XF95, XF105	609	48	1 376 729	34980 01	1793875	VESA2054



6.0 KABINA I DELOVI KABINE



6.0 KABINA I DELOVI KABINE

6.1	Delovi kabine	118
6.2	Ogledala i delovi ogledala	138
6.3	Cilindri i pumpe za dizanje kabine	140
6.4	Elementi za oslanjanje kabine	141
6.5	Uređaji za pranje vetrobranskog stakla	144
6.6	Mehanizam vrata	145



KARO0062
1363375



KARO0060
1438577



KARO0061
1438573



KARO0652
1385179

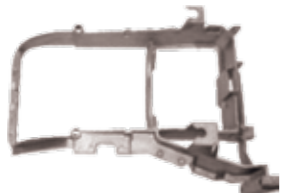

KARO0653
1385178

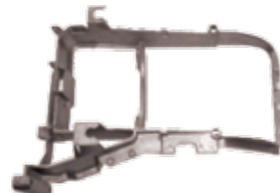

KARO0058
1363374



KARO0059
1363373



RASV0599
1699299



RASV0600
1699297



KARO0654
1372535



KARO0655
1372536



KARO0656
1372537



KARO0657
1372534



KARO0067
1699468



KARO0063
1372533



KARO0066
1362871



KARO0065
1362870



KARO0064
1372532



KARO0068
1363370





KARO0069
1437810

KARO0070
1437809



KARO0071
750899

KARO0072
962101



KARO0073
1364799

KARO0074
1364798

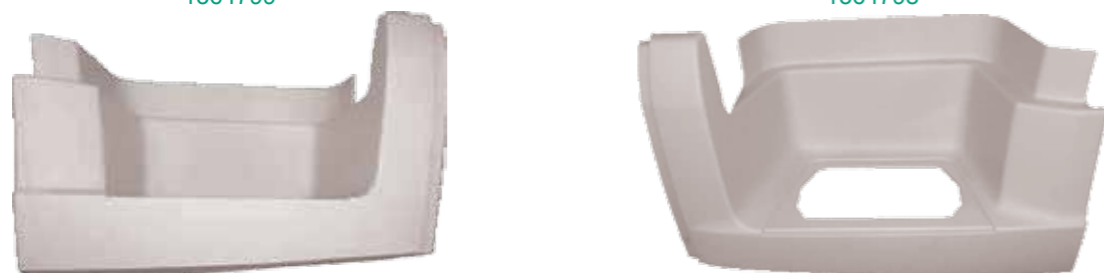

KARO0075
1638481

KARO0076
1638480



KARO0077
0083118

KARO0847
0082196

KARO0848
0082195

KARO0078
0083117



KARO0659
1363820

KARO0658
1363821



KARO0079
1393645

KARO0080
1393646



KARO0081
1389297

POGLED OD NAZAD

POGLED OD NAZAD

KARO0082
1389296



6.1 DELOVI KABINE - CF/XF 95-105



KARO0083
1745335



KARO0996
1693114



KARO0086
1328935



KARO0084
1340450



KARO0085
1328934



KARO0085
1328934



6.1 DELOVI KABINE - XF 95



KARO0849
1300041



KARO0099 *
1290191



KARO0104 *
948779



SERIJA 1
KARO0096
1294949



SERIJA 1
KARO0097
1294948



KARO0100
1449529



KARO0101
1449528

KARO0102 *
1450977



KARO0105 *
1319679



KARO0103 *
1319678



KARO0107 *
1450976



* DAF XF 95 SERIJA 1-2



SERIJA 2
KARO0108
1398285



SERIJA 2
KARO0109
1398284



KARO0984
1396937

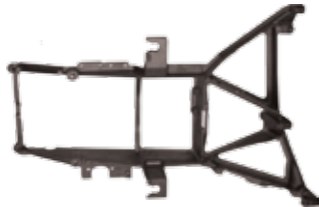

KARO0939
1396936

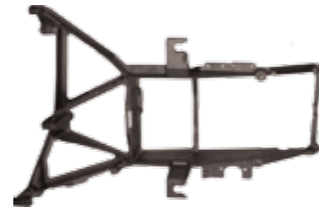

RASV0283
1699299



RASV0282
1699297



KARO0110
1291173



KARO0114
673144

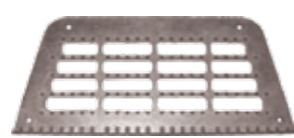

KARO0111
1291172



KARO0115
673143

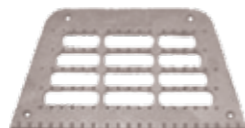

* DAF XF 95 SERIJA 1-2



KARO0112 *
1295620



KARO0113 *
1295619



KARO0116 (SERIJA 1)
1347132



KARO0117 (SERIJA 1)
1347131



KARO0118 *
1295735



KARO0119 *
1295732



KARO0121 (SERIJA 2)
1605933

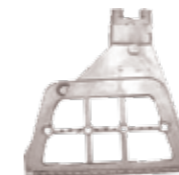

KARO0122 (SERIJA 2)
1605932



KARO0120 *
962643





KARO0123
1302984



KARO0124 (SERIJA 2)
1400012



KARO0126 (SERIJA 2)
1400011



KARO0125
1302983



KARO0127 (SERIJA 2)
1400014



KARO0130 *
1309113



KARO0131 *
1309112



KARO0128 (SERIJA 2)
1400013



KARO0129
1312789

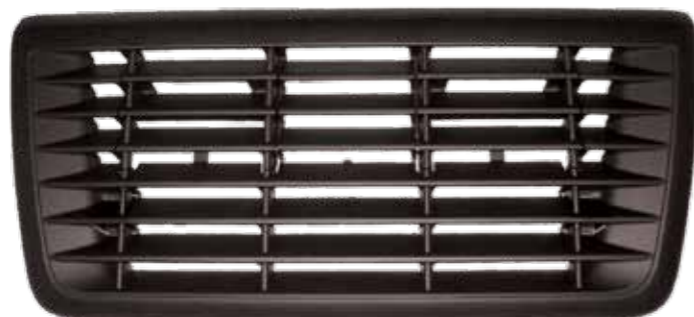

KARO0132 *
1336468



KARO0133 *
1336467



KARO0133 *
1336467



KARO0132 *
1336468



* DAF XF 95 SERIJA 1-2



KARO0660
1294285



KARO0661
1294284



KARO0134
1291165



KARO0135
1291164



KARO0662
1393654



KARO0663
1393653



KARO0664
1291169



KARO0665
1291168



KARO0666
1389297



POGLED OD NAZAD



POGLED OD NAZAD



KARO0667
1389296





KARO0098
1427140

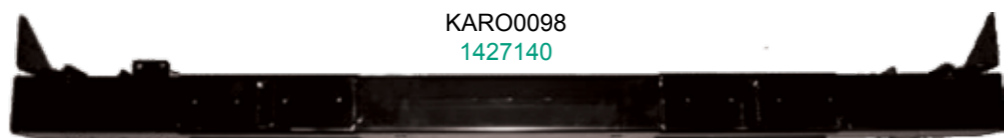

KARO0136
1634640



KARO0435
1683722



KARO0138
1683721



KARO0984
1396937



KARO0939
1396936

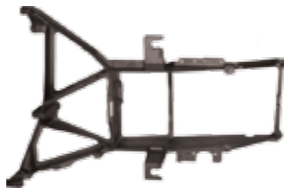

KARO0668
1641631



KARO0575
1635802



KARO0669
1641630

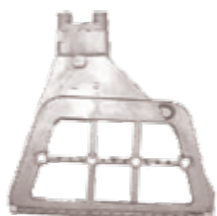

KARO0139
1642683



KARO0140
1642682



KARO0108
1398285



KARO0109
1398284



KARO0112
1295620



KARO0113
1295619



KARO0666
1389297



POGLED OD NAZAD



POGLED OD NAZAD



KARO0667
1389296





KARO1743
1798449



KARO1744
1798448



KARO1745
1861950



KARO1746
1861949



KARO1747
1922031



KARO1748
1922030



RASV1605
1835875



RASV1604
1835874



KARO1752
1869588



KARO1751
1826510



KARO1753
1861983



KARO1749
1880379



KARO1750
1880378



RASV1611
1835887



RASV1612
1835886





KARO1725
1835710



KARO1726
1835709



KARO1727
1886591



KARO1728
1835171



KARO1729
1835170



KARO1730
1835024



KARO1731
1835023



KARO1732
1798462



KARO1733
1798461



KARO1736
1828856



KARO1737
1828855



KARO1734
1798464



KARO1735
1798463





KARO1738
1875551



KARO1754
1875551



KARO1755
1927847



KARO1741
1875554



KARO1742
1875553



KARO1746
1875567



KARO1739
1875550



KARO1740
1875549



KABI1361
1286384



XF105			
Poz.	Naziv	OE broj	RAPIDEX broj
1.	SUNCOBRAN	1286384	KABI1361





KABI1362
1300557

KABI1363
1311765



XF95			
Poz.	Naziv	OE broj	RAPIDEX broj
1.	SUNCOBRAN	1300557	KABI1362
2.	SET ZA MONTAŽU	1311765	KABI1363



KABI0755
1311875

KABI0756
1434334



CF			
Poz.	Naziv	OE broj	RAPIDEX broj
1.	SUNCOBRAN	1311875	KABI0755
2.	SET ZA MONTAŽU	1434334	KABI0756



65CF, 75CF, 85CF, 95XF (2000 - 2006)



OE broj	MEKRA broj	Opis	Položaj	Grejač	Dimenzije (mm)	RAPIDEX broj
1425104	61.3730.324H		◀ ▶		384 x 205 x 120	KABI0387
1425105	61.3730.326H		◀ ▶		384 x 205 x 120	KABI0381
1425109	15.3731.470H				368 x 189 x 40	KABI0469
1425113	11.3730.210H					KABI0470

65CF, 75CF, 85CF, 95XF (2000 - 2006)



OE broj	MEKRA broj	Opis	Položaj	Grejač	Dimenzije (mm)	RAPIDEX broj
1425108	61.3860.214H		◀ ▶		219 x 170 x 120	KABI0471
1425111	15.3861.114H				203 x 154 x 36	KABI0472
1425114	11.3860.500H					KABI0473

65CF, 75CF, 85CF, 95XF (2000 - 2006)



OE broj	MEKRA broj	Opis	Položaj	Grejač	Dimenzije (mm)	RAPIDEX broj
1670877	61.9065.114H		◀ ▶		209 x 218 x 136	KABI0474
1670878	15.9060.870H				204 x 195 x 58	KABI0475
1670888	11.9060.100H					KABI0476

XF105, CF (2006 - ...)



OE broj	MEKRA broj	Opis	Položaj	Grejač	Dimenzije (mm)	RAPIDEX broj
1692557	61.5700.210H		◀ ▶		411 x 228 x 140	KABI0477
1689348	61.5700.110H		◀ ▶		411 x 228 x 140	KABI0478
1685330	15.5701.840H				363 x 177 x 15	KABI0479
1644325	11.5700.100H					KABI1206

XF105, CF (2006 - ...)



OE broj	MEKRA broj	Opis	Položaj	Grejač	Dimenzije (mm)	RAPIDEX broj
1692556	61.5710.210H		◀ ▶		239 x 221 x 140	KABI0481
1689347	61.5710.310H		◀ ▶		239 x 221 x 140	KABI0482
1685331	15.5711.870H				207 x 161 x 15	KABI0483
1644326	11.5710.110H					KABI1268

XF105, CF (2006 - ...)



OE broj	MEKRA broj	Opis	Položaj	Grejač	Dimenzije (mm)	RAPIDEX broj
1685324	58.5701.100H		◀		818 x ... x 40	KABI0485
1685325	58.5701.200H		▶		818 x ... x 40	KABI0486
1644324	20.5700.410H					KABI0487

XF105, CF (2006 - ...)



OE broj	MEKRA broj	Opis	Položaj	Grejač	Dimenzije (mm)	RAPIDEX broj
1669573	59.5520.230H		◀ ▶		319 x 187 x 50	KABI0488

KABLOVI OGLEDALA



OE broj	Model vozila	Opis	Položaj	Grejač	Dimenzije (mm)	RAPIDEX broj
09.5700.001	XF105	-	-	-	-	OPRE0694
09.5700.002	XF105	-	-	-	-	OPRE0695

LEGENDA:



MANUELNO
PODEŠAVANJE



STAKLO



GREJAČ



LEVI POLOŽAJ



ELEKTRIČNO
PODEŠAVANJE



PLOKLOPAC
KUČIŠTE



UNIVERZALAN
POLOŽAJ



DESNI POLOŽAJ

CILINDRI ZA DIZANJE KABINE			
Poz.	Model vozila	OE broj	RAPIDEX broj
1.	95XF	1346200	KABI1429
2.	XF95	1295724	KABI0269
3.	XF105	1444742	KABI1426

PUMPE ZA DIZANJE KABINE				
Poz.	Slika	Model vozila	OE broj	RAPIDEX broj
1.		95XF	1315492	KABI1428
2.		XF95/105	1450903	KABI1427

ELEMENTI ZA OSLANJANJE KABINE			
Poz.	Slika	Model vozila / OE broj	RAPIDEX broj
1.		XF95	KABI0392
		1. 1290794 x 2 2. 1304576 x 2 3. 1290795 x 4 4. 0212045 x 2 5. 0661173 x 2	
2.		XF95	KABI0569
		1. 0077390 x 2 2. 1266426 x 4 3. 1271385 x 4 4. 0079330 x 2 5. 1269537 x 2 6. 0325081 x 2	
3.		XF95	KABI0570
		1. 1290794 x 2 2. 1332194 x 2 3. 1304576 x 2 4. 1656266 x 4 5. 1290795 x 4 6. 0661173 x 2 7. 1399159 x 4	
4.		XF95, XF105	KABI0391
		1. 1314545 x 2 2. 1332194 x 2 3. 1304569 x 2 4. 1266426 x 4 5. 1271385 x 4 6. 1269537 x 2 7. 0241496 x 2 8. 0661173 x 2	

ELEMENTI ZA OSLANJANJE KABINE			
Poz.	Slika	Model vozila / OE broj	RAPIDEX broj
5.		XF95, XF105 1. 1314545 x 2 2. 1304569 x 2 3. 0661173 x 2	KABI0261
6.		XF95, XF105 1. 1332194 x 2 2. 1266426 x 4 3. 1271385 x 4 4. 1269537 x 2 5. 0241496 x 2	KABI0262
7.		F65, 75, 85, CF65, 75, 85 1. 1396202 x 4 2. 0750928 x 2 3. 1304576 x 2 4. 1269537 x 2 5. 0079330 x 2 6. 0661173 x 2 7. 1248753 x 2 8. 1328885 x 2 9. 1656266 x 4 10. 1399159 x 4	KABI0571



ELEMENTI ZA OSLANJANJE KABINE					
Poz.	Slika	Model vozila	Dimenzije (mm)	OE broj	RAPIDEX broj
1.		65, F75, 85	85 x 20 x 23,8	1396202	KABI0572
2.		XF95	60 x 20 x 48	1290794	KABI0573
3.		XF95	85 x 20 x 8	1290795	KABI0575
4.		XF95	25 x 136,5	1332192	KABI0577
5.		XF95, XF105	90 x 20 x 70	1314545	KABI0574
6.		XF95, XF105	62 x 48 x 5,7	1271385	KABI0576
7.		XF95, XF105	51 x 30 x 25 x 20	1266426	KABI0578

UREĐAJI ZA PRANJE VETROBRANSKOG STAKLA

Poz.	Model vozila	Opis	OE broj	RAPIDEX broj
1.	F95, 95XF, XF95, XF105	MEHANIZAM BRISAČA 550	1288698	KABI0620
2.	F95, 95XF, XF95, XF105	MOTOR BRISAČA	1254891	ELEK0106
3.	F95, 95XF	POLUGA BRISAČA	1245443	KABI0626
4.	F95, 95XF	POLUGA BRISAČA	1245445	KABI0627
5.	F95, 95XF	POLUGA BRISAČA	1245444	KABI0628
6.	F95, 95XF, XF95, XF105	PUMPICA BRISAČA	1343064	KABI0632
7.	F95, 95XF, XF95, XF105	RUČICA BRISAČA	1238778	KABI0636
8.	F95, 95XF, XF95, XF105	RUČICA BRISAČA	1238779	KABI0637
9.	LF	METLICA BRISAČA 600/600 mm	-	KABI1078
10.	95XF, XF95, XF105	METLICA BRISAČA 550 mm	-	KABI0974
11.	95XF, XF95, XF105	METLICA BRISAČA 500 mm	-	KABI1058

MEHANIZAM VRATA

Poz.	Model vozila	Opis	Položaj	OE broj	RAPIDEX broj
1.	CF65, 75, 85, 95XF	BRAVA VRATA	◀	1296590	KABI0655
2.	CF65, 75, 85, 95XF	BRAVA VRATA	▶	1296591	KABI0656
3.	F95, 95XF, XF95, XF105	KVAKA VRATA	◀	1305481	KABI0670
4.	F95, 95XF, XF95, XF105	KVAKA VRATA	▶	1305482	KABI0671
5.	F95, 95XF, XF95, XF105	PODIZAČ PROZORA SA MOTOROM	◀	1354702	KABI0674
6.	F95, 95XF, XF95, XF105	PODIZAČ PROZORA SA MOTOROM	▶	1354703	KABI0675
7.	F95, 95XF, XF95, XF105	VENTIL GREJANJA		1331724	KABI0688

7.0 ELEKTRIČNE INSTALACIJE



7.0 ELEKTRIČNE INSTALACIJE

7.1	Farovi	148
7.2	Pokazivači pravca	152
7.3	Stop i gabaritna svetla	153
7.4	Rotacione lampe	157
7.5	Sijalice, osigurači i tahograf listići	160
7.6	Kablovi električne instalacije	165
7.7	Kombinovani prekidači pod volanom	168
7.8	Pribori	169
7.9	Anlaseri i alternatori	170

65, 75, 85 (1993 - 1995) 65CF, 75CF, 85CF (1998 - 2000)



OE broj	OPIS	RAPIDEX broj
1293369	▶ H4	RASV0586
1293368	◀ M	RASV0587
1318140	▶ STAKLO	RASV0588
1318135	◀ STAKLO	RASV0589

95XF (1997 - 2002)



OE broj	OPIS	RAPIDEX broj
1293361	▶ H4	RASV0476
1293360	◀ M	RASV0475
1318150	▶ STAKLO	RASV0596
1318149	◀ STAKLO	RASV0597

CF65, CF75, CF85, LF45, LF55 (01.2001 - ...) XF95 (04.1997 - 09.2002)



OE broj	OPIS	RAPIDEX broj
1328861	▶ H1 H3	RASV1039
1328860	◀ H1 H3	RASV0323

CF65, CF75, CF85, LF45, LF55, XF95 (01.2001 - ...) XF105 (2005 - ...)



OE broj	OPIS	RAPIDEX broj
1699299	▶ E H1 H7	RASV1041
1699297	◀ E H1 H7	RASV1040
1699301	▶ M H1 H7	RASV0283
1699300	◀ M H1 H7	RASV0282

CF85, XF105 (2009 - ...)



OE broj	OPIS	RAPIDEX broj
1743691	▶ E D2S H1	RASV0601
1743690	◀ E D2S H1	RASV0602

CF65, CF75, CF85, LF45, LF55 (01.2001 - ...) XF95, XF105



OE broj	OPIS	RAPIDEX broj
1725271	▶ H3	RASV0435
1725270	◀ H3	RASV0159

XF106 (2013 - ...) LED



OE broj	OPIS	RAPIDEX broj
1835875	▶ E H1 H7	RASV1605
1835874	◀ E H1 H7	RASV1604

XF106 (2013 - ...)



OE broj	OPIS	RAPIDEX broj
1835887	▶ H11	RASV1611
1835886	◀ H11	RASV1612

UNIVERZALNI FAR

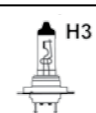
KBP	OPIS	RAPIDEX broj
1G3 005 760-021	  Ø152 mm	RASV0718

UNIVERZALNI FAR

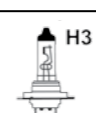
KBP	OPIS	RAPIDEX broj
1GA 005 060-001	  153 x 93 mm	RASV0230

UNIVERZALNI FAR

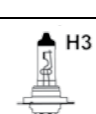
KBP	OPIS	RAPIDEX broj
1GA 006 991-021	  158 x 105 mm	RASV0719

UNIVERZALNI FAR

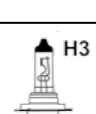
KBP	OPIS	RAPIDEX broj
1GA 006 991-081 44.120.000	  112 x 102mm	RASV0168

UNIVERZALNI FAR

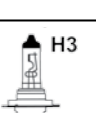
KBP	OPIS	RAPIDEX broj
44.040.500	  170 x 100 mm	RASV0167

LED UNIVERZALNI FAR

KBP	OPIS	RAPIDEX broj
91017420	 LED 9-30 V, 1200 LUMENA 105 x 124	RASV0546

LED UNIVERZALNI FAR

KBP	OPIS	RAPIDEX broj
098174090	 LED 9-30 V, 1200 LUMENA 140 x 114	RASV1342

XF95 (1987-1997)



OE broj	OPIS	RAPIDEX broj
0066698		RASV0170

95XF (1997 - 2002)



OE broj	OPIS	RAPIDEX broj
1301368		RASV0726

LF (2001 - ...)



OE broj	OPIS	RAPIDEX broj
1626101		RASV0073



LF (2001 - ...)



OE broj	OPIS	RAPIDEX broj
1401713		RASV0224
1401731	 350 x 133 mm	RASV0223
1451482	► STAKLO ◄ STAKLO	RASV0369

65, 75, 85 (1993 - 1998), 95XF (1987 - 1997)

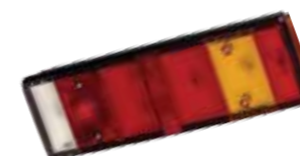

OE broj	OPIS	RAPIDEX broj
1626320		RASV0302
1626319	 468 x 134 mm	RASV0301
1272653	► STAKLO ◄ STAKLO	RASV0306

CF, XF95, XF105 (1997 - ...)



OE broj	OPIS	RAPIDEX broj
1625986		RASV0311
1625985	 468 x 134 mm	RASV0299
1272653	► STAKLO ◄ STAKLO	RASV0306

XF105, XF106 (2010 - ...)



OE broj	OPIS	RAPIDEX broj
1875576		RASV1215
1875577	 400 x 160 mm	RASV1214
1914691	► STAKLO	RASV1213
1914690	◄ STAKLO	RASV1212

RIKVERC ALARMI

Poz.	Slika	Naziv / Opis	RAPIDEX broj
1.		RIKVERC ALARM 12/24 V, 97 dB	OSTA0370
2.		RIKVERC ALARM 12/24 V, 97 dB	OSTA0247

65, 75, 85, 65CF, 75CF, 85CF

OE broj	OPIS	RAPIDEX broj				
703214431	 <table border="1"> <thead> <tr> <th>OPIS</th> <th>RAPIDEX broj</th> </tr> </thead> <tbody> <tr> <td>12/24V C5W-SV8,5</td> <td>RASV0412</td> </tr> </tbody> </table>	OPIS	RAPIDEX broj	12/24V C5W-SV8,5	RASV0412	RASV0412
OPIS	RAPIDEX broj					
12/24V C5W-SV8,5	RASV0412					

65CF, 75CF, 85CF, XF95, XF105

OE broj	OPIS	RAPIDEX broj				
1850102	 <table border="1"> <thead> <tr> <th>OPIS</th> <th>RAPIDEX broj</th> </tr> </thead> <tbody> <tr> <td>LED</td> <td>ELEK1375</td> </tr> </tbody> </table>	OPIS	RAPIDEX broj	LED	ELEK1375	ELEK1375
OPIS	RAPIDEX broj					
LED	ELEK1375					

65CF, 75CF, 85CF, XF95, XF105

OE broj	OPIS	RAPIDEX broj				
1329718	 <table border="1"> <thead> <tr> <th>OPIS</th> <th>RAPIDEX broj</th> </tr> </thead> <tbody> <tr> <td>24V W5W-W2,1X9,5D</td> <td>RASV1231</td> </tr> </tbody> </table>	OPIS	RAPIDEX broj	24V W5W-W2,1X9,5D	RASV1231	RASV1231
OPIS	RAPIDEX broj					
24V W5W-W2,1X9,5D	RASV1231					

65CF, 75CF, 85CF, XF95, XF105

OE broj	OPIS	RAPIDEX broj				
1653605	 <table border="1"> <thead> <tr> <th>OPIS</th> <th>RAPIDEX broj</th> </tr> </thead> <tbody> <tr> <td>24V W5W-W2,1X9,5D</td> <td>RASV0846</td> </tr> </tbody> </table>	OPIS	RAPIDEX broj	24V W5W-W2,1X9,5D	RASV0846	RASV0846
OPIS	RAPIDEX broj					
24V W5W-W2,1X9,5D	RASV0846					

XF105 (2006 - ...)

KBP	OPIS	RAPIDEX broj				
098 221 397	 <table border="1"> <thead> <tr> <th>OPIS</th> <th>RAPIDEX broj</th> </tr> </thead> <tbody> <tr> <td>24V LED</td> <td>ELEK1606</td> </tr> </tbody> </table>	OPIS	RAPIDEX broj	24V LED	ELEK1606	ELEK1606
OPIS	RAPIDEX broj					
24V LED	ELEK1606					

SVETLA REGISTRAR TABLICE

KBP	OPIS	RAPIDEX broj				
2KA 003 389-061	<table border="1"> <thead> <tr> <th>OPIS</th> <th>RAPIDEX broj</th> </tr> </thead> <tbody> <tr> <td>12/24V R10W-Ba15s</td> <td>RASV0396</td> </tr> </tbody> </table>	OPIS	RAPIDEX broj	12/24V R10W-Ba15s	RASV0396	RASV0396
OPIS	RAPIDEX broj					
12/24V R10W-Ba15s	RASV0396					



KBP	OPIS	RAPIDEX broj				
26-3010-004	<table border="1"> <thead> <tr> <th>OPIS</th> <th>RAPIDEX broj</th> </tr> </thead> <tbody> <tr> <td>12/24V C5W-SV8,5</td> <td>RASV0075</td> </tr> </tbody> </table>	OPIS	RAPIDEX broj	12/24V C5W-SV8,5	RASV0075	RASV0075
OPIS	RAPIDEX broj					
12/24V C5W-SV8,5	RASV0075					



KBP	OPIS	RAPIDEX broj				
26-3000-004	<table border="1"> <thead> <tr> <th>OPIS</th> <th>RAPIDEX broj</th> </tr> </thead> <tbody> <tr> <td>12/24V C5W-SV8,5</td> <td>RASV0105</td> </tr> </tbody> </table>	OPIS	RAPIDEX broj	12/24V C5W-SV8,5	RASV0105	RASV0105
OPIS	RAPIDEX broj					
12/24V C5W-SV8,5	RASV0105					



KBP	OPIS	RAPIDEX broj				
-	<table border="1"> <thead> <tr> <th>OPIS</th> <th>RAPIDEX broj</th> </tr> </thead> <tbody> <tr> <td>LED</td> <td>RASV0521</td> </tr> </tbody> </table>	OPIS	RAPIDEX broj	LED	RASV0521	RASV0521
OPIS	RAPIDEX broj					
LED	RASV0521					



KBP	OPIS	RAPIDEX broj				
-	<table border="1"> <thead> <tr> <th>OPIS</th> <th>RAPIDEX broj</th> </tr> </thead> <tbody> <tr> <td>LED</td> <td>RASV1440</td> </tr> </tbody> </table>	OPIS	RAPIDEX broj	LED	RASV1440	RASV1440
OPIS	RAPIDEX broj					
LED	RASV1440					

KATADIOPTERI

KBP	OPIS		RAPIDEX broj
8RA 002 014-041	BELI	Ø 60 mm	RASV0861
8RA 002 014-051	ŽUTI		RASV0459
8RA 002 014-031	CRVENI		RASV0460
8RA 003 326-021	BELI	94 x 44 mm	RASV0458
8RA 003 326-011	ŽUTI		RASV0457
8RA 003 326-001	CRVENI		RASV0410
01.090.7520.05			RASV0222



KL 7000 F



KBP	OPIS		RAPIDEX broj
2RL 008 061-101	12V		RASV0862
2RL 008 061-111	24V		RASV0863
9EL 862 141-001	ŽUTO STAKLO		RASV0864
9EL 862 140-001	PLAVO STAKLO		RASV0865

KL 7000 M



KBP	OPIS		RAPIDEX broj
2RL 008 062-101	12/24V		RASV0866
2RL 008 062-111	24/12V		RASV0867
9EL 862 141-001	ŽUTO STAKLO		RASV0864
9EL 862 140-001	PLAVO STAKLO		RASV0865

KL 7000 M



KBP	OPIS		RAPIDEX broj
2RL 008 062-001	12/24V		RASV0868
2RL 008 062-011	24/12V		RASV0869
9EL 862 141-001	ŽUTO STAKLO		RASV0864
9EL 862 140-001	PLAVO STAKLO		RASV0865

KL 7000 R

KBP	OPIS	RAPIDEX broj
2RL 008 060-101	12/24V	 H1 RASV0870
2RL 008 060-111	24/12V	
9EL 862 141-001	ŽUTO STAKLO	RASV0864
9EL 862 140-001	PLAVO STAKLO	RASV0865

JUNIOR PLUS F

KBP	OPIS	RAPIDEX broj
2RL 008 965-001	12V	 H1 RASV0467
2RL 008 965-011	24V	
9EL 863 100-001	ŽUTO STAKLO	RASV0873

JUNIOR F

KBP	OPIS	RAPIDEX broj
2RL 007 550-001	12V	 H1 RASV0533
2RL 007 550-011	24V	
9EL 860 627-001	ŽUTO STAKLO	RASV0505
9EL 860 628-021	PLAVO STAKLO	RASV0874

JUNIOR M

KBP	OPIS	RAPIDEX broj
2RL 007 552-001	12V	 H1 RASV0560
2RL 007 552-011	24V	
9EL 860 627-001	ŽUTO STAKLO	RASV0505
9EL 860 628-021	PLAVO STAKLO	RASV0874

JUNIOR R

KBP	OPIS	RAPIDEX broj
2RL 007 551-001	12V	 H1 RASV0055
2RL 007 551-011	24V	
9EL 860 627-001	ŽUTO STAKLO	RASV0505
9EL 860 628-021	PLAVO STAKLO	RASV0874

H1 - P14,5s

OPIS	RAPIDEX broj
12V H1-55W	RASV1089
24V H1-70W	RASV1088

H2 - H511

OPIS	RAPIDEX broj
12V H2-55W	RASV0880
24V H2-70W	RASV0881

H3 - PK22s

OPIS	RAPIDEX broj
12V H3-55W	RASV1105
24V H3-70W	ELEK0294

H4 - P43t

OPIS	RAPIDEX broj
12V H4-60/55W	RASV1085
24V H4-75/70W	ELEK0295

H7 - Px26d

OPIS	RAPIDEX broj
12V H7-55W	RASV1084
24V H7-70W	RASV1078

H8 - PGJ19-1

OPIS	RAPIDEX broj
12V H8-35W	RASV0882

H9 - PGJ19-5

OPIS	RAPIDEX broj
12V H9-55W	RASV0877

H10 - PY20d

OPIS	RAPIDEX broj
12V H10-42W	RASV0883

H11 - PGJ19-2

OPIS	RAPIDEX broj
12V H11-55W	RASV0878
24V H11-70W	RASV0879

H21W - BAY9s

OPIS	RAPIDEX broj
12V H21W	RASV0884
24V H21W	RASV1079

D2R - P32d3

OPIS	RAPIDEX broj
D2R-35W	RASV0885

D2S - P32d2

OPIS	RAPIDEX broj
D2S-35W	RASV0886

R2 - P45t

OPIS	RAPIDEX broj
12V R2-45/40W	RASV0550
24V R2-55/50W	RASV0571

P21W - BA15s

OPIS	RAPIDEX broj
12V P21W	RASV1083
24V P21W	ELEK0293

PY21W - BAU15s

OPIS	RAPIDEX broj
12V PY21W	RASV0562
24V PY21W	RASV0499

P21/5W - BAY15d

OPIS	RAPIDEX broj
12V P21/5W	RASV0535
24V P21/5W	RASV1076

R5W - BA15s

OPIS	RAPIDEX broj
12V R5W	RASV1082
24V R5W	RASV1072

R10W - BA15s

OPIS	RAPIDEX broj
12V R10W	RASV0490
24V R10W	RASV1075

C5W - SV8,5

OPIS	RAPIDEX broj
12V C5W	RASV0887
24V C5W	RASV1074

C10W - SV8,5

OPIS	RAPIDEX broj
12V C10W	RASV0888
24V C10W	RASV0315

T3W - BA9s

OPIS	RAPIDEX broj
12V T3W	RASV0502
24V T3W	RASV0501

T4W - BA9s

OPIS	RAPIDEX broj
12V T4W	ELEK0291
24V T4W	RASV1071

W3W - W2,1x9,5d

OPIS	RAPIDEX broj
12V W3W	RASV0564
24V W3W	RASV0569

W5W - W2,1x9,5d

OPIS	RAPIDEX broj
12V W5W	RASV0484
24V W5W	RASV1073

W1,2W - W2x4,6d

OPIS	RAPIDEX broj
12V W1,2W	RASV0563
24V W1,2W	RASV1069

W1,2W - B8,3d

OPIS	RAPIDEX broj
12V W1,2W	RASV0893
24V W1,2W	RASV1070

GARNITURA SIJALICA H7

OPIS	RAPIDEX broj
12V H7	RASV1180
24V H7	RASV1081

GARNITURA SIJALICA H4

OPIS	RAPIDEX broj
12V H4	RASV1086
24V H4	RASV1080

GARNITURA SIJALICA H7

OPIS	RAPIDEX broj
2 x 24V H7	RASV0892

GARNITURA SIJALICA H4

OPIS	RAPIDEX broj
2 x 24V H4	RASV0895

OSIGURAČI UBODNI

Slika	Poz.	Opis	KBP	RAPIDEX broj
	1.	5A OKER	8JS 711 684-002	ELEK0684
	2.	7,5A BRAON	8JS 711 685-002	ELEK0258
	3.	10A CRVENI	8JS 711 686-002	RASV0568
	4.	15A PLAVI	8JS 711 687-002	RASV0567
	5.	20A ŽUTI	8JS 711 688-002	ELEK0257
	6.	25A BELI	8JS 711 689-002	ELEK0575
	7.	30A ZELENI	8JS 711 690-002	RASV0539
	8.	40A NARANDŽASTI	8JS 711 683-031	ELEK0769

OSIGURAČI UBODNI - MINI

Slika	Poz.	Opis	KBP	RAPIDEX broj
	1.	5A	8JS 728 596-131	RASV0183
	2.	7,5A	8JS 728 596-111	RASV0184
	3.	10A	8JS 728 596-141	RASV0185
	4.	15A	8JS 728 596-151	RASV0186
	5.	20A	8JS 728 596-161	RASV0187
	6.	25A	8JS 728 596-091	RASV0188
	7.	30A	8JS 728 596-171	RASV0189

OSIGURAČI UBODNI - MAXI

Slika	Poz.	Opis	KBP	RAPIDEX broj
	1.	20A	8JS 728 595-051	RASV0920
	2.	30A	8JS 728 595-141	RASV0921
	3.	40A	8JS 728 595-151	RASV0922
	4.	50A	8JS 728 595-161	RASV0923
	5.	60A	8JS 728 595-171	RASV0924
	6.	70A	8JS 728 595-101	RASV0925
	7.	80A	8JS 728 595-111	RASV0927

OSIGURAČI - MIDI

Slika	Poz.	Opis	KBP	RAPIDEX broj
	1.	30A	8JS 742 901-061	RASV0928
	2.	50A	8JS 742 901-011	RASV0929
	3.	150A	8JS 742 901-081	RASV0052

OSIGURAČI - MEGA

Slika	Poz.	Opis	KBP	RAPIDEX broj
	1.	125A	8JS 742 902-011	RASV0930
	2.	150A	8JS 742 902-021	RASV0931
	3.	200A	8JS 742 902-041	RASV0932
	4.	250A	8JS 742 902-051	RASV0933
	5.	300A	8JS 742 902-071	RASV0934

TAHOGRAF LISTIĆI

Slika	Poz.	Opis	RAPIDEX broj
	1.	100-24 EC4K	OPRE0210
	2.	100-3300-24 EC4	OPRE0220
	3.	125-24 EC4K	OPRE0224
	4.	125-3300-24 EC4KA	OPRE0122
	5.	140-24 EC4K	OPRE0216
	6.	SERTIFIKAT-VIKEND	OPRE0105
	7.	ROLNICA ZA DIGITALNI TAHOGRAF	ELEK1112



SPIRALNI KABLOVI

Slika	Poz.	Opis	KBP	RAPIDEX broj
	1.	7 - ŽILNI	611 110	ELEK0609
	2.	ISO 1724 7 - lni	8KA 004 797-021	ELEK0770
	3.	ISO 1185 7 - lni	8KA 004 797-041	ELEK0287
	4.	ISO 3731 7 - lni	8KA 004 797-051	ELEK0370
	5.	ISO 7638 ABS/EBS	446 008 700 0	ELEK1368
	6.	ISO 12098 15 - lni	446 008 710 0	ELEK1122
	7.	15/2 x 7 - lni	8JA 005 952-041	ELEK0450

ADAPTER				
Slika	Poz.	Opis	KBP	RAPIDEX broj
	1.	15/2 x 7 - lin	8JA 005 952-061	ELEK0247

UTIKAČI				
Slika	Poz.	Opis	KBP	RAPIDEX broj
	1.	ISO 1724 7 - Ini 12V	8JA 001 930-003	ELEK0607
	2.	ISO 1185 7 - Ini	8JA 008 831-001	RASV0541
	3.	ISO 3731 7 - Ini	8JA 008 832-011	ELEK0491
	4.	ISO 7638 ABS/EBS	8JB 007 645-031	ELEK0470
	5.	ISO 12098 15 - Ini	8JA 007 241-031	ELEK0250

UTIČNICE				
Slika	Poz.	Opis	KBP	RAPIDEX broj
	1.	ISO 1724 7 - Ini 12V	8JB 001 943-003	ELEK0606
	2.	ISO 1185 7 - Ini	8JB 003 833-001	RASV0513
	3.	ISO 3731 7 - Ini	8JB 003 834-001	RASV0452
	4.	ISO 7638 ABS/EBS	8JB 007 645-031	ELEK0402
	5.	ISO 12098 15 - Ini	8JB 007 242-011	ELEK0249

KOMBINOVANI PREKIDAČI POD VOLANOM				
Slika	Poz.	Model vozila	OE broj	RAPIDEX broj
	1.	95XF	1615081	ELEK0784
	2.	XF105	1669662	ELEK1441





PRIBORI		
Slika	Opis	RAPIDEX broj
	Kablovi za startovanje 25 mm ² x 3,5 m	ELEK0554
	Kablovi za startovanje 35 mm ² x 4,5 m	ELEK0703
	Kablovi za startovanje 50 mm ² x 7 m	ELEK0704
	Kontakt klešta 25 - 50 mm ²	ELEK0705
	Klemna +	ELEK0640
	Klemna -	ELEK0600
	Merač kiseline	ELEK0706

75CF, CF75				
Slika	Opis	KBP	OE broj	RAPIDEX broj
	24 V 4 kW 11 Z	0 001 231 013	1346162	ELEK0726

CF85, 95XF, XF95				
Slika	Opis	KBP	OE broj	RAPIDEX broj
	24 V 5,5 kW 12 Z	0 001 241 007	1667205	ELEK1027

CF85, XF95, XF105				
Slika	Opis	KBP	OE broj	RAPIDEX broj
	24 V 5,5 kW 12 Z	0 001 241 006	1688625	ELEK1962

CF, XF95, XF105				
Slika	Opis	KBP	OE broj	RAPIDEX broj
	28 V 80 A PK7 Ø86 mm	0 124 555 018	1626130	ELEK1879
	28 V 110 A PK7 Ø86 mm	0 124 655 014	1649066	ELEK1917

CF, XF95, XF105				
Slika	Opis	KBP	OE broj	RAPIDEX broj
	28 V 100 A	0 124 655 003	1697322	ELEK1090



8.0 PRIBORI



8.0 PRIBORI

8.1	Obeležavajuće table i pribori A.D.R.	174
8.2	Oprema	189
8.3	Pribor za osiguravanje tereta	192
8.4	Lanci za sneg	194
8.5	Vučne kuke	196
8.6	Grejanje kabine	199

REFLEKTUJUĆE I FLUOROSCENTNE TABLE ZA KAMIONE SAGLASNO REGULATIVI ECE 70

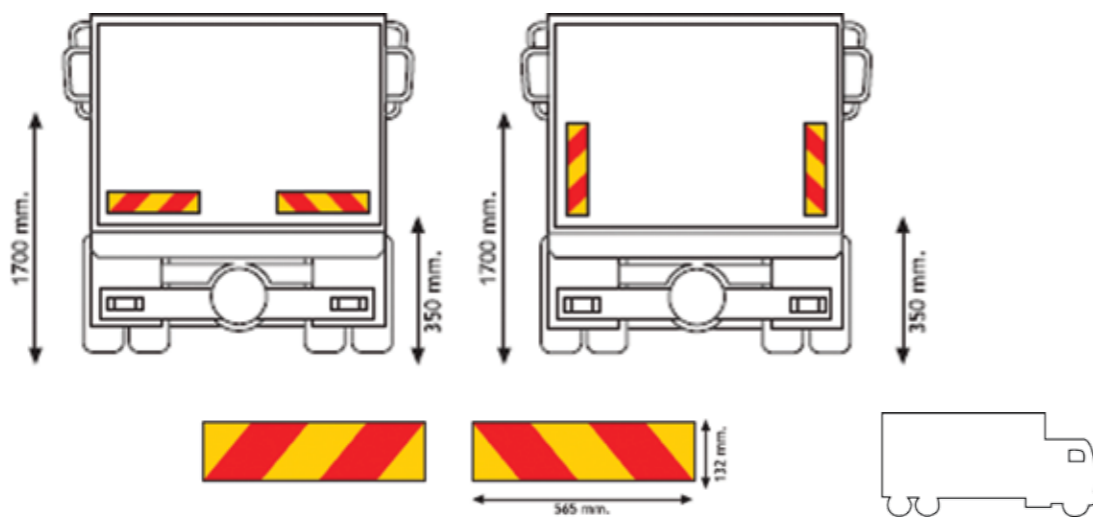

Poz.	Dimenzije (mm)	Opis	Jedinica mere	RAPIDEX broj
1.	565 x 132	Aluminijum	PAR	OPRE0097

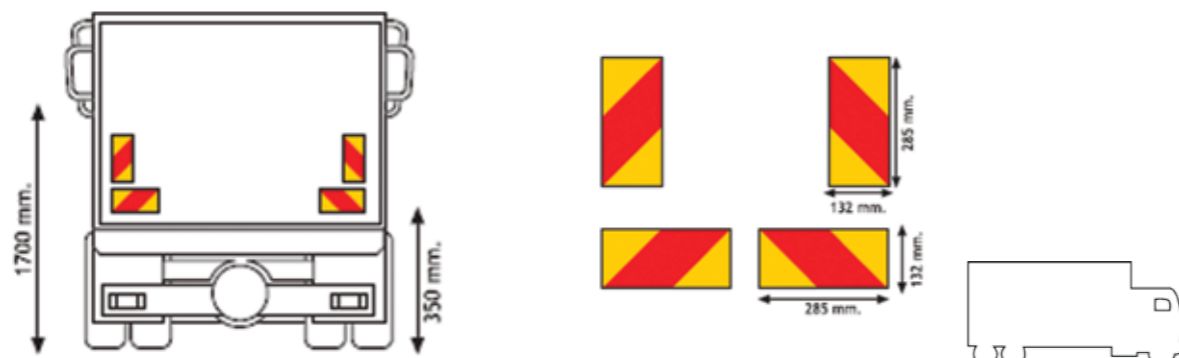

Poz.	Dimenzije (mm)	Opis	Jedinica mere	RAPIDEX broj
2.	285 x 132	Aluminijum	PAR	OPRE0260

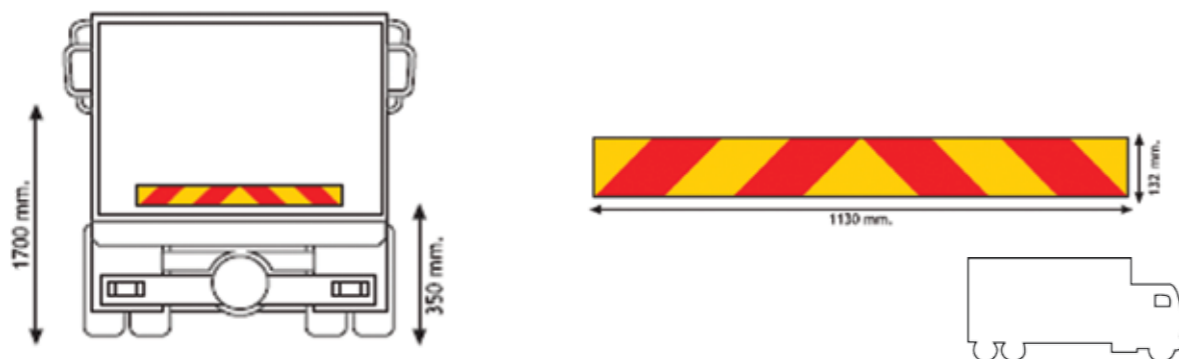

Poz.	Dimenzije (mm)	Opis	Jedinica mere	RAPIDEX broj
3.	1130 x 196	Aluminijum	KOM	OPRE0261

REFLEKTUJUĆE I FLUOROSCENTNE TABLE ZA KAMIONE SAGLASNO REGULATIVI ECE 70

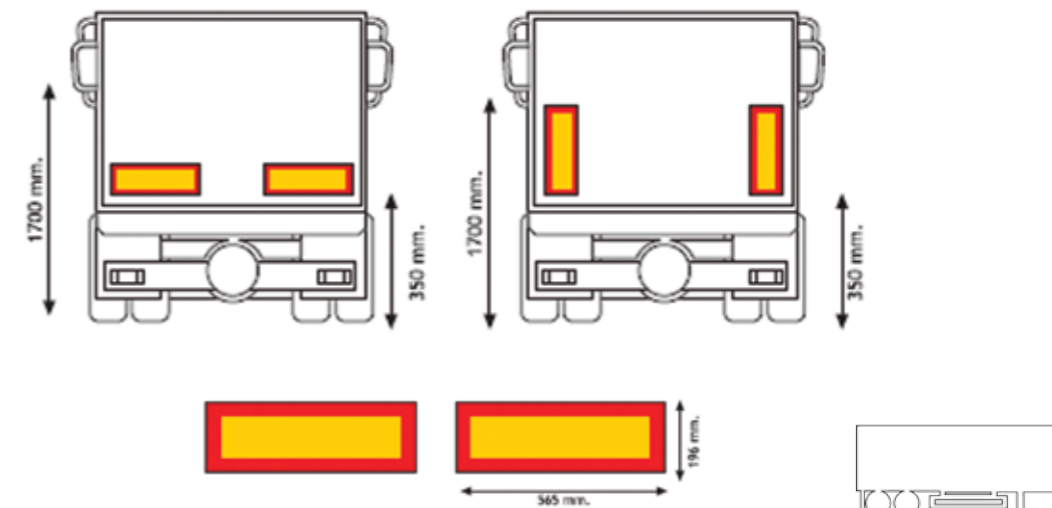

Poz.	Dimenzije (mm)	Opis	Jedinica mere	RAPIDEX broj
1.	565 x 196	Aluminijum	PAR	OPRE0157

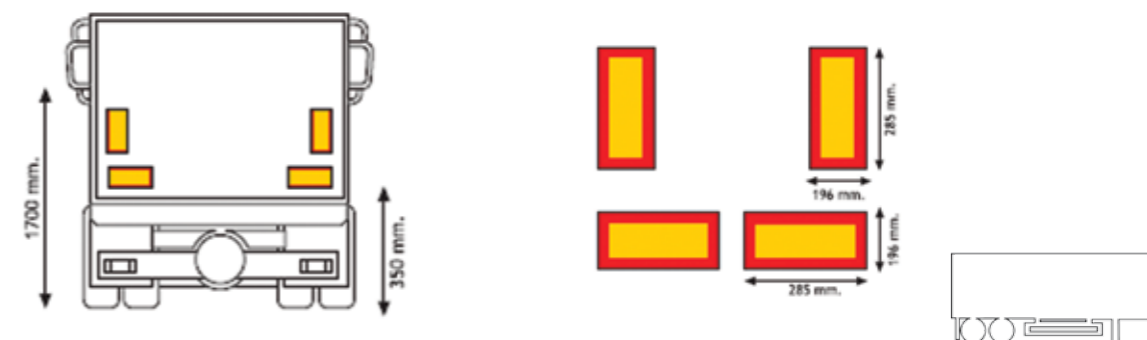

Poz.	Dimenzije (mm)	Opis	Jedinica mere	RAPIDEX broj
2.	285 x 196	Aluminijum	PAR	OPRE0262

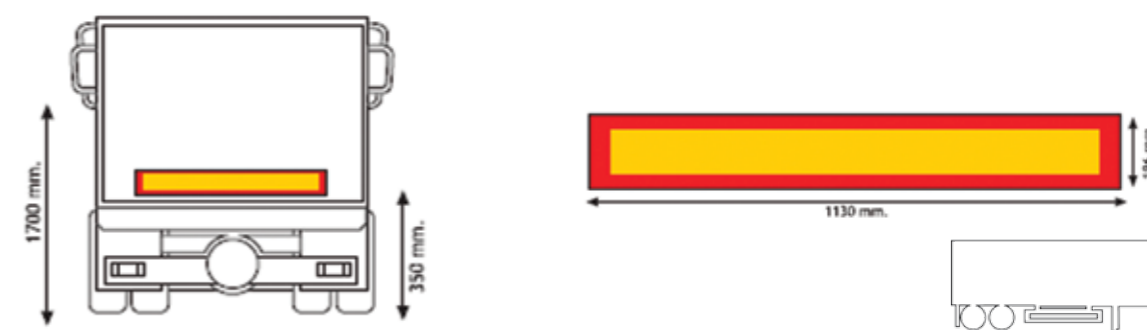

Poz.	Dimenzije (mm)	Opis	Jedinica mere	RAPIDEX broj
3.	1130 x 196	Aluminijum	KOM	OPRE0090

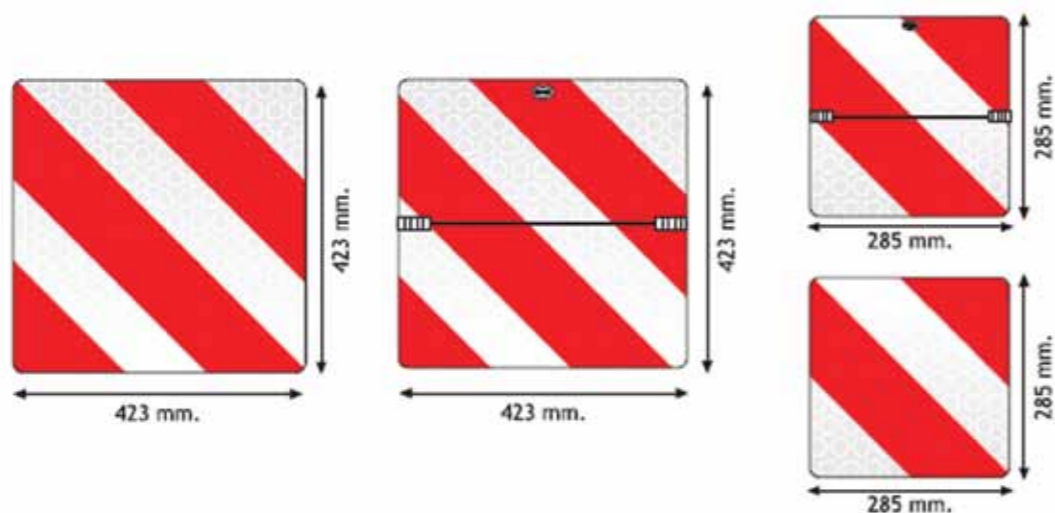
**REFLEKTUJUĆE TABLE ZA PREVOZ TERETA
VAN DOZVOLJENIH GABARITA**

Poz.	Dimenzije (mm)	Opis	Jedinica mere	RAPIDEX broj
1.	423 x 423	Aluminijum / Panel	kom	OPRE0142
2.	423 x 423	Aluminijum / Preklopiva	kom	OPRE0263
3.	285 x 285	Aluminijum / Preklopiva	kom	OPRE0265
4.	285 x 285	Aluminijum / Panel	kom	OPRE0264

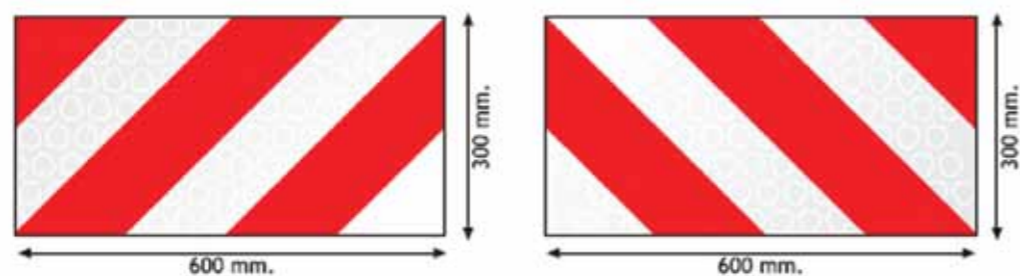

Poz.	Dimenzije (mm)	Opis	Jedinica mere	RAPIDEX broj
5.	600 x 300	Aluminijum / Panel	set	OPRE0266

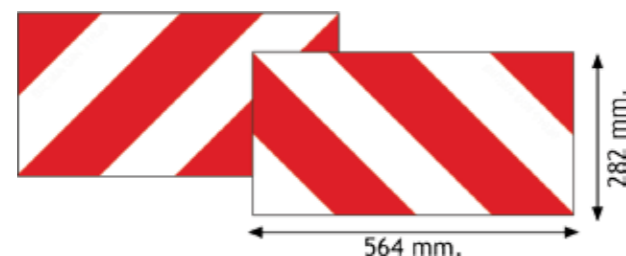

Poz.	Dimenzije (mm)	Opis	Jedinica mere	RAPIDEX broj
6.	564 x 282	Aluminijum / Panel	set	OPRE0267

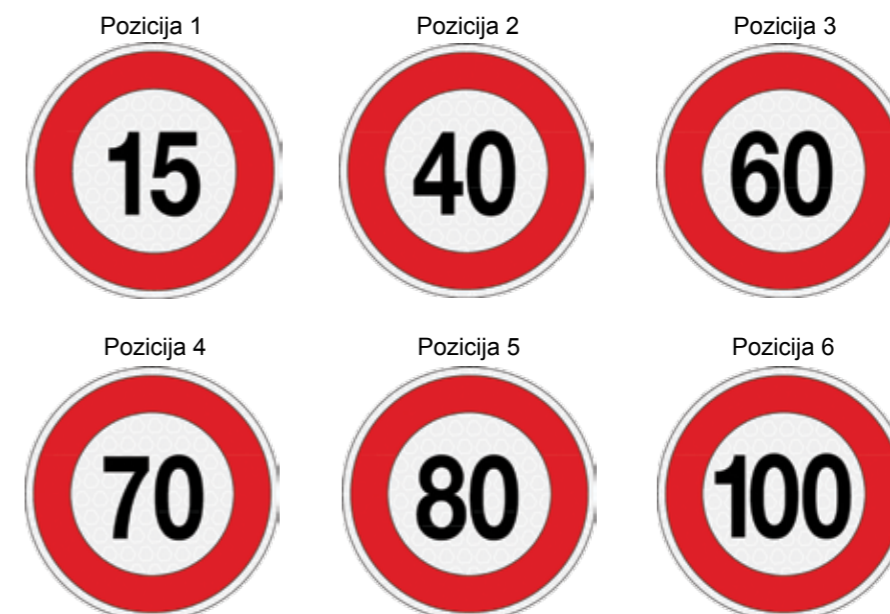
REFLEKTUJUĆE TABLE OGRANIČENJA BRZINE

Poz.	Dimenzije (mm)	Opis	RAPIDEX broj
1.	Ø 200	Nalepnica	OPRE0268
		Aluminijum	OPRE0269
2.	Ø 200	Nalepnica	OPRE0270
		Aluminijum	OPRE0271
3.	Ø 200	Nalepnica	OPRE0272
		Aluminijum	OPRE0273
4.	Ø 200	Nalepnica	OPRE0274
		Aluminijum	OPRE0275
5.	Ø 200	Nalepnica	OPRE0276
		Aluminijum	OPRE0277
6.	Ø 200	Nalepnica	OPRE0278
		Aluminijum	OPRE0279

OZNAČAVAJUĆE TABLE ZA PREVOZ DECE

Poz.	Dimenzije (mm)	Opis	RAPIDEX broj
1.	400 x 400	Aluminijum	OPRE0280
2.	400 x 400	Aluminijum / Preklopiva - Horizontalno	OPRE0089
3.	400 x 400	Nalepnica	OPRE0282

IDENTIFIKACIONE OZNAKE VOZILA

Poz.	Dimenzije (mm)	Opis	RAPIDEX broj
1.	Ø 200	Aluminijum	OPRE0283
2.	Ø 200	Aluminijum	OPRE0284
3.	Ø 200	Aluminijum	OPRE0285
4.	Ø 200	Aluminijum	OPRE0286
5.	Ø 200	Aluminijum	OPRE0055
6.	Ø 200	Aluminijum	OPRE0056
7.	Ø 200	Aluminijum	OPRE0057



Poz.	Dimenzije (mm)	Opis	RAPIDEX broj
1.	Ø 200	Aluminijum	OPRE0287
2.	Ø 200	Aluminijum	OPRE0288
3.	Ø 200	Aluminijum	OPRE0289



Poz.	Dimenzije (mm)	Opis	RAPIDEX broj
1.	400 x 250	Aluminijum	OPRE0290
2.	400 x 250	Aluminijum / Preklopiva - Horizontalno	OPRE0154
3.	400 x 250	Aluminijum / Preklopiva - Vertikalno	OPRE0291

UPOZORAVAJUĆE TABLE HIDRAULIČNIH ZADNJIH VRATA

Poz.	Opis	RAPIDEX broj
1.	Aluminijumska tabla / desna strana	OPRE0292
2.	Aluminijumska tabla / leva strana	OPRE0293
3.	Aluminijumska tabla sa nosačem / desna strana	OPRE0294
4.	Aluminijumska tabla sa nosačem / leva strana	OPRE0295
5.	Aluminijumske table sa nosačima / desna i leva strana - set	OPRE0296

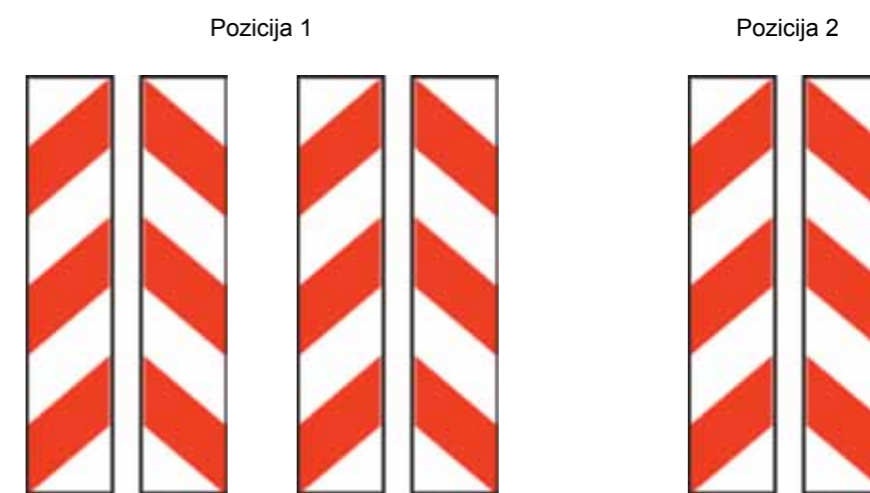
**IDENTIFIKACIONE TABLE ZA VOZILA I KONTEJNERE
SAGLASNO REGULATIVI DIN 67520**

Poz.	Dimenzije (mm)	Opis	RAPIDEX broj
1.	141 x 705	Aluminijum / SET (4 desne + 4 leve table)	OPRE0297
2.	141 x 705	Aluminijum / SET (1 desne + 1 leve table)	OPRE0298

REFLEKTUJUĆE TRAKE ZA VOZILA
SAGLASNO REGULATIVI EEC U.N.104

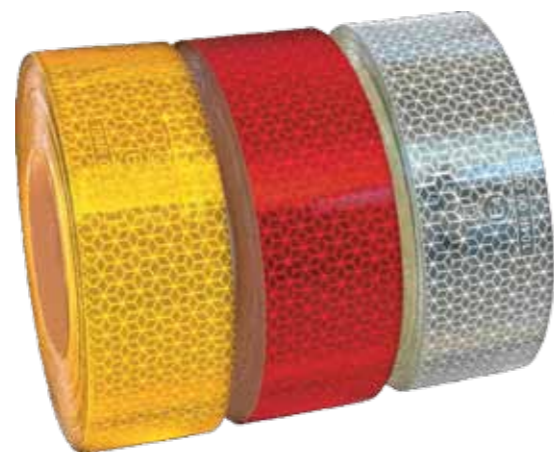

Poz.	Opis	RAPIDEX broj
1.	Reflektujuća traka žute boje 50 mm x 50 m	OSTA1056
2.	Reflektujuća traka crvene boje 50 mm x 50 m	OSTA1057
3.	Reflektujuća traka bele boje 50 mm x 50 m	OSTA1058



Poz.	Opis	RAPIDEX broj
1.	Reflektujuća traka žute boje 50 mm x 50 m	OPRE1055
2.	Reflektujuća traka crvene boje 50 mm x 50 m	OPRE1054
3.	Reflektujuća traka bele boje 50 mm x 50 m	OPRE1053

REFLEKTUJUĆE TRAKE ZA VOZILA
SAGLASNO REGULATIVI EEC U.N.104

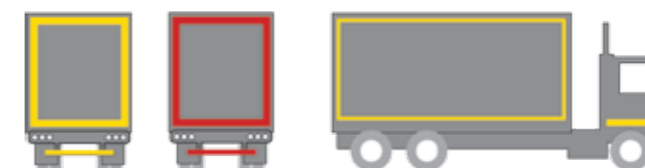
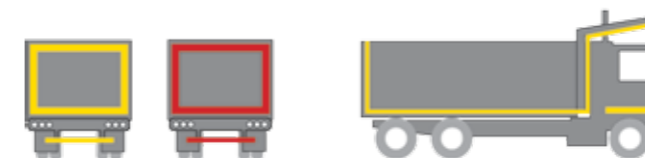
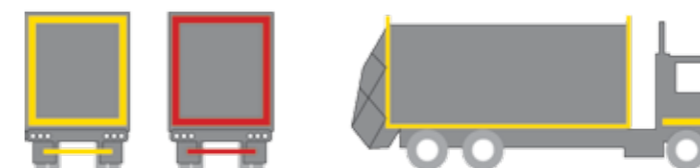
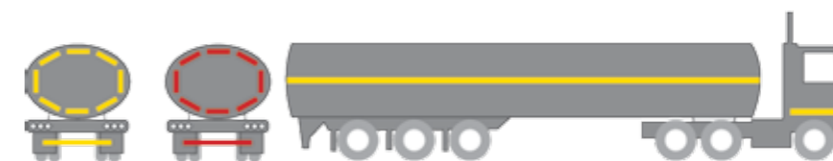
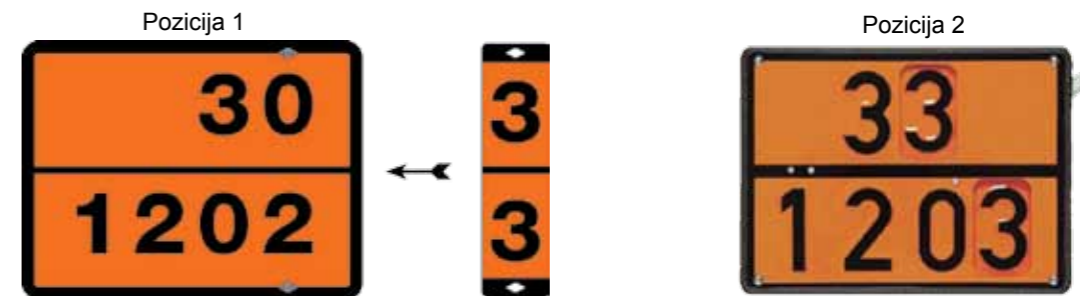

TABLE A.D.R.



Poz.	Dimenzije (mm)	Opis	RAPIDEX broj
1.	400 x 300	Aluminijum	OPRE0153
2.	400 x 300	Aluminijum / Preklopiva - Vertikalno	OPRE0152
3.	400 x 300	Aluminijum / Preklopiva - Horizontalno	OPRE0302



Poz.	Dimenzije (mm)	Opis	RAPIDEX broj
1.	400 x 300	30 - 1202 - Dizel	OPRE0035
2.	400 x 300	33 - 1203 - Benzin	OPRE0036
3.	400 x 300	30 - 1223 - Kerozin	OPRE0037
4.	400 x 300	23 - 1965 - LPG	OPRE0038
5.	400 x 300	23 - 1978 - Propan	OPRE0039
6.	400 x 300	23 - 1971 - Prirodni gas	OPRE0040
7.	400 x 300	23 - 1951 - Tečni argon	OPRE0041
8.	400 x 300	22 - 1977 - Tečni azot	OPRE0042
9.	400 x 300	22 - 2187 - Tečni CO ₂	OPRE0043
10.	400 x 300	223 - 1966 - Tečni vodonik	OPRE0044
11.	400 x 300	225 - 1073 - Tečni kiseonik	OPRE0045
12.	400 x 300	263 - 1040 - Etilenoksid	OPRE0046
13.	400 x 300	23 - 1011 - Butan	OPRE0047
14.	400 x 300	223 - 1038 - Tečni etilen	OPRE0048
15.	400 x 300	223 - 1972 - Tečni prirodni gas	OPRE0049
16.	400 x 300	30 - 1202 - Dizel / Preklopiva - Horizontalno	OPRE0052
17.	400 x 300	33 - 1203 - Benzin / Preklopiva - Horizontalno	OPRE0053
18.	400 x 300	30 - 1202 - Dizel / Preklopiva - Vertikalno	OPRE0303
19.	400 x 300	33 - 1203 - Benzin / Preklopiva - Vertikalno	OPRE0304

TABLE A.D.R.

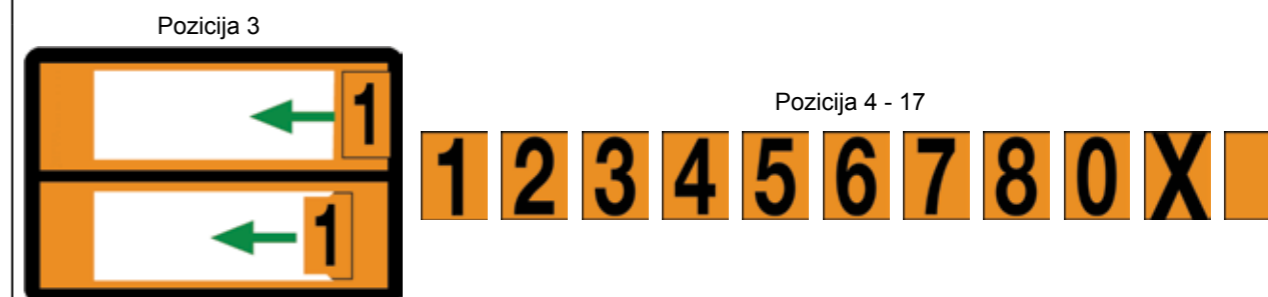
Poz.	Dimenzije (mm)	Opis	RAPIDEX broj
1.	400 x 300	Izmenljiva tabla za dizel i benzin	OPRE0305
2.	400 x 300	Izmenljiva tabla sa ručicom za dizel i benzin	OPRE0054



Poz.	Dimenzije (mm)	Opis	RAPIDEX broj
3.	400 x 300	Tabla(nosač) A.D.R. za različite trasporte	OPRE0034
4.	70 x 118	Set od 10 simbola za tablu A.D.R.: 0 - 2 kom.; 1 - 1 kom.; 2 - 2 kom.; 3 - 3 kom.; Prazno polje - 2 kom.	OPRE0050
5.	70 x 118	Set od 12 simbola za tablu A.D.R.: 1 - 1 kom.; 2 - 1 kom.; 3 - 2 kom.; 5 - 1 kom.; 6 - 3 kom.; 7 - 1 kom.; 8 - 1 kom.; Prazno polje - 2 komada	OPRE0051
6.	70 x 118	Set od 33 simbola za tablu A.D.R.: 0 - 3 kom.; 1 - 3 kom.; 2 - 3 kom.; 3 - 4 kom.; 4 - 2 kom.; 5 - 3 kom.; 6 - 5 kom.; 7 - 2 kom.; 8 - 3 kom.; X - 2 kom.; Prazno polje - 3 komada	OPRE0306
7.	70 x 118	Broj 1 za tablu A.D.R.	OPRE0307
8.	70 x 118	Broj 2 za tablu A.D.R.	OPRE0308
9.	70 x 118	Broj 3 za tablu A.D.R.	OPRE0309
10.	70 x 118	Broj 4 za tablu A.D.R.	OPRE0310
11.	70 x 118	Broj 5 za tablu A.D.R.	OPRE0311
12.	70 x 118	Broj 6 za tablu A.D.R.	OPRE0312
13.	70 x 118	Broj 7 za tablu A.D.R.	OPRE0313
14.	70 x 118	Broj 8 za tablu A.D.R.	OPRE0314
15.	70 x 118	Broj 0 za tablu A.D.R.	OPRE0315
16.	70 x 118	Simbol X za tablu A.D.R.	OPRE0316
17.	70 x 118	Prazno polje za tablu A.D.R.	OPRE0317

TABLE ZA OZNAČAVANJE OPASNIH MATERIJIA 300 x 300 mm

	Klasa 1.1, 1.2, 1.3 RAPIDEX broj: OPRE0318		Klasa 1.4 RAPIDEX broj: OPRE0320		Klasa 1.5 RAPIDEX broj: OPRE0319
	Klasa 1.6 RAPIDEX broj: OPRE0321		Klasa 2 RAPIDEX broj: OPRE0322		Klasa 2 RAPIDEX broj: OPRE0323
	Klasa 2 RAPIDEX broj: OPRE0324		Klasa 3 RAPIDEX broj: OPRE0340		Klasa 4.1 RAPIDEX broj: OPRE0325
	Klasa 4.2 RAPIDEX broj: OPRE0326		Klasa 4.3 RAPIDEX broj: OPRE0327		Klasa 5 RAPIDEX broj: OPRE0328
	Klasa 5.1 RAPIDEX broj: OPRE0329		Klasa 5.2 RAPIDEX broj: OPRE0330		Klasa 6.1 RAPIDEX broj: OPRE0331
	Klasa 6.2 RAPIDEX broj: OPRE0332		Klasa 7/A RAPIDEX broj: OPRE0333		Klasa 7/B RAPIDEX broj: OPRE0334
	Klasa 7/C RAPIDEX broj: OPRE0335		Klasa 7 RAPIDEX broj: OPRE0336		Klasa 8 RAPIDEX broj: OPRE0337
	Klasa 9 RAPIDEX broj: OPRE0338		Klasa 9 RAPIDEX broj: OPRE0339		

TABLE ZA OZNAČAVANJE OPASNIH MATERIJIA

KLASA	OPASNE MATERIJIE
1	Eksplozivne materije i predmeti punjeni eksplozivnim materijama
2	Zbijeni gasovi, gasovi pretvoreni u tečnost i gasovi rastvoreni pod pritiskom
3	Zapaljive tečnosti
4.1	Zapaljive čvrste materije
4.2	Materije sklone samopaljenju
4.3	Materije koje u dodiru sa vodom razvijaju zapaljive gasove
5.1	Oksidirajuće materije
5.2	Organski peroksidi
6.1	Otrovi
6.2	Gadne i zarazne materije
7	Radioaktivne materije
8	Korozivne (nagrizajuće) materije
9	Ostale opasne materije.

KUTIJA ZA PROTIVPOŽARNI APARAT



RAPIDEX broj:
OPRE0886

TEHNIČKE KARAKTERISTIKE:



Spoljašnje mere: 277 x 277 x 635 mm

Unutrašnje mere: 140 ÷ 185 mm

Kapacitet: 6 kg

Ostale karakteristike: vatrootporna, vodootporna i otporna na vibracije

PRIBORI A.D.R.

Slika	Opis	RAPIDEX broj
	Torba A.D.R. Sadrži: PVC rukavice, sredstvo za ispiranje očiju, zaštitne naočare, kompletnu masku, filter zaštitne maske i kecelju	OPRE00315
	Torba A.D.R. Sadrži: PVC rukavice, sredstvo za ispiranje očiju, zaštitne naočare, polumasku, filter zaštitne maske i kecelju	OPRE0070



PRIBORI A.D.R.

Slika	Opis	RAPIDEX broj
	Poklopac za kanalizacioni otvor 1000 x 1000 mm	OPRE0341
	Poklopac za kanalizacioni otvor 2000 x 3000 mm	OPRE0342
	Absorbujući granulat	OPRE0343
	Zaštitno odelo	OPRE0344
	Zaštitna šlem	OPRE0345
	Cipele	OPRE0346

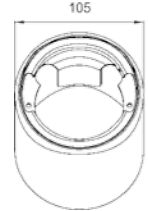

PRIBORI A.D.R.		
Slika	Opis	RAPIDEX broj
	Reflektujući prsluk	OPRE0147
	Trougao upozorenja	OPRE0930
	Čunj	OPRE0347
	Čunj - reflektujući	OPRE0348
	Upozoravajuća lampa	OPRE0349
	Baterijska lampa	OPRE0350
	Preklapajuća lopata	OPRE0128

OPREMA		
Slika	Opis	RAPIDEX broj
	GUMENE ZAVESE 450 x 300 mm	OPRE0549
	GUMENE ZAVESE 650 x 400 mm	OPRE0548
	GUMENE ZAVESE 2400 x 400 mm	OPRE0541
	KLOCNA TOČKA metalna 160 mm	OPRE0359
	KLOCNA TOČKA metalna 200 mm	OPRE0183
	KLOCNA TOČKA plastična 160 mm	OSTA3577
	KLOCNA TOČKA plastična 200 mm	OPRE0912
	NOSAČ ZA KLOCNU 160 mm	OPRE0941
	NOSAČ ZA KLOCNU 200 mm	OPRE0947
	KUTIJA ZA ALAT 600 x 450 x 470 mm 700 x 450 x 650 mm 800 x 450 x 470 mm 1000 x 500 x 470 mm	OPRE0813 OPRE0950 OPRE0949 OPRE0948
	DIZALICA 8 t 12 t 16 t 20 t 30 t	OPRE0360 OPRE0361 OPRE0362 OPRE0208 OPRE0364
	RUDA ZA VUČU	OPRE0194
	PRIBOR ZA ČIŠĆENJE KABINE VOZAČA	OPRE0029

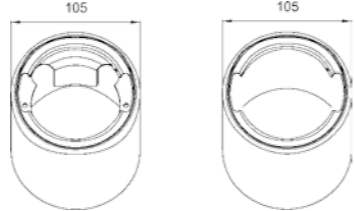
ZAŠTITA REZERVOARA OD KRAĐE GORIVA - KOCKON 105

RAPIDEX broj:	OPRE0814	RAPIDEX broj:	OPRE0803
			

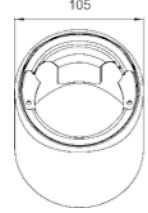

ZAŠTITA REZERVOARA OD KRAĐE GORIVA - KOCKON 105 I ČEP

RAPIDEX broj:	OPRE0804	RAPIDEX broj:	OPRE0830
			

ČEP ZIPPER 105

RAPIDEX broj:	OPRE0808
	

ZAŠTITA REZERVOARA OD KRAĐE GORIVA - TERMOKING

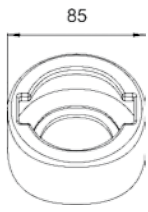
RAPIDEX broj:	OPRE0819	RAPIDEX broj:	OPRE0820
			



PRIBOR ZA OSIGURAVANJE TERETA

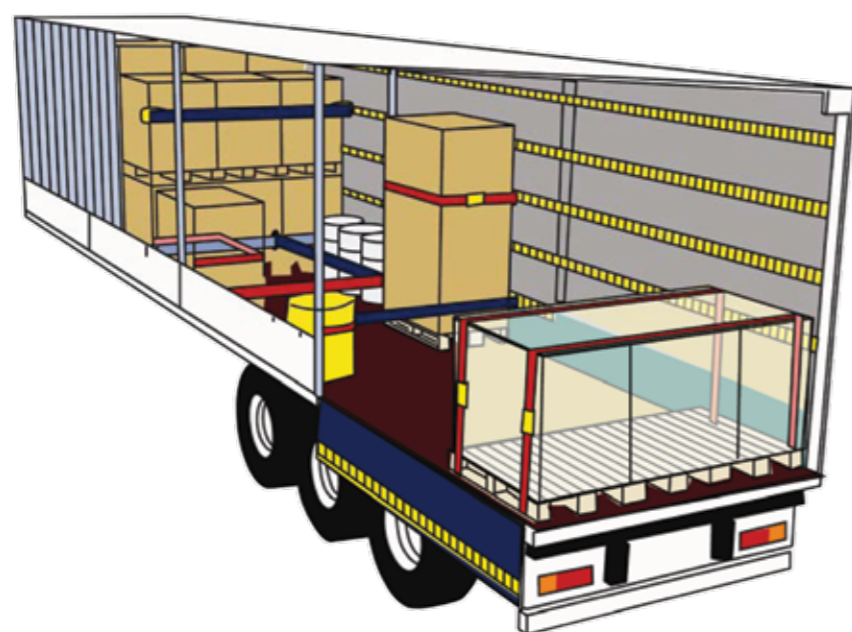
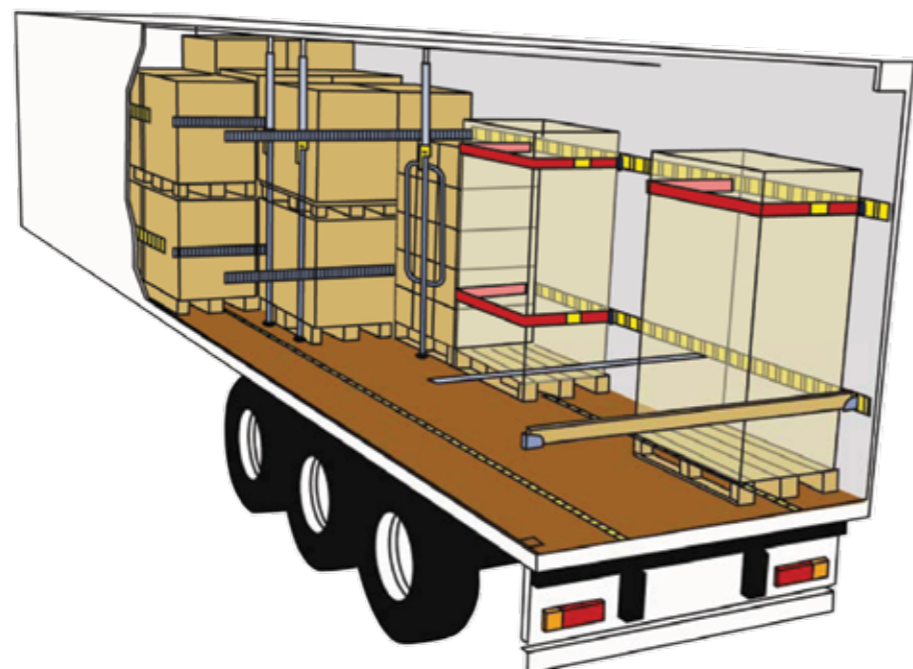

PRIBOR ZA OSIGURAVANJE TERETA



Poz.	Naziv	Dimenzije	Nosivost (daN)		RAPIDEX broj
1.	Traka za vezivanje tereta KPL	8 m x 50 mm	2500	5000	OPRE0185
2.	Traka za vezivanje tereta KPL	10 m x 50 mm	2500	5000	OSTA5110
3.	Traka za vezivanje tereta KPL	12 m x 50 mm	2500	5000	OPRE0170
4.	Traka za vezivanje tereta KPL Duga ručka	8 m x 50 mm	2500	5000	OPRE0780
5.	Traka za vezivanje tereta KPL Duga ručka	10 m x 50 mm	2500	5000	OPRE1409
6.	Traka za vezivanje tereta	10 m x 50 mm	2500	5000	OPRE0001
7.	Štitnik robe	180 x 140 x 150 mm			OPRE0939



Poz.	Naziv	Dimenzije		RAPIDEX broj
1.	Letva ADR - aluminijum	21 - 36 mm	2400 - 2700 mm	OPRE0132



Poz.	Naziv	Dimenzije		RAPIDEX broj
1.	Držač - aluminijum	Ø42 mm	2100 - 2470 mm	OPRE0353
2.	Držač - aluminijum	Ø38 mm	2260 - 2630 mm	OPRE0133
3.	Držač - aluminijum	Ø42 mm	2350 - 2720 mm	OPRE0134
4.	Držač - aluminijum	Ø42 mm	2575 - 2965 mm	OPRE0700

8.4 LANCI ZA SNEG

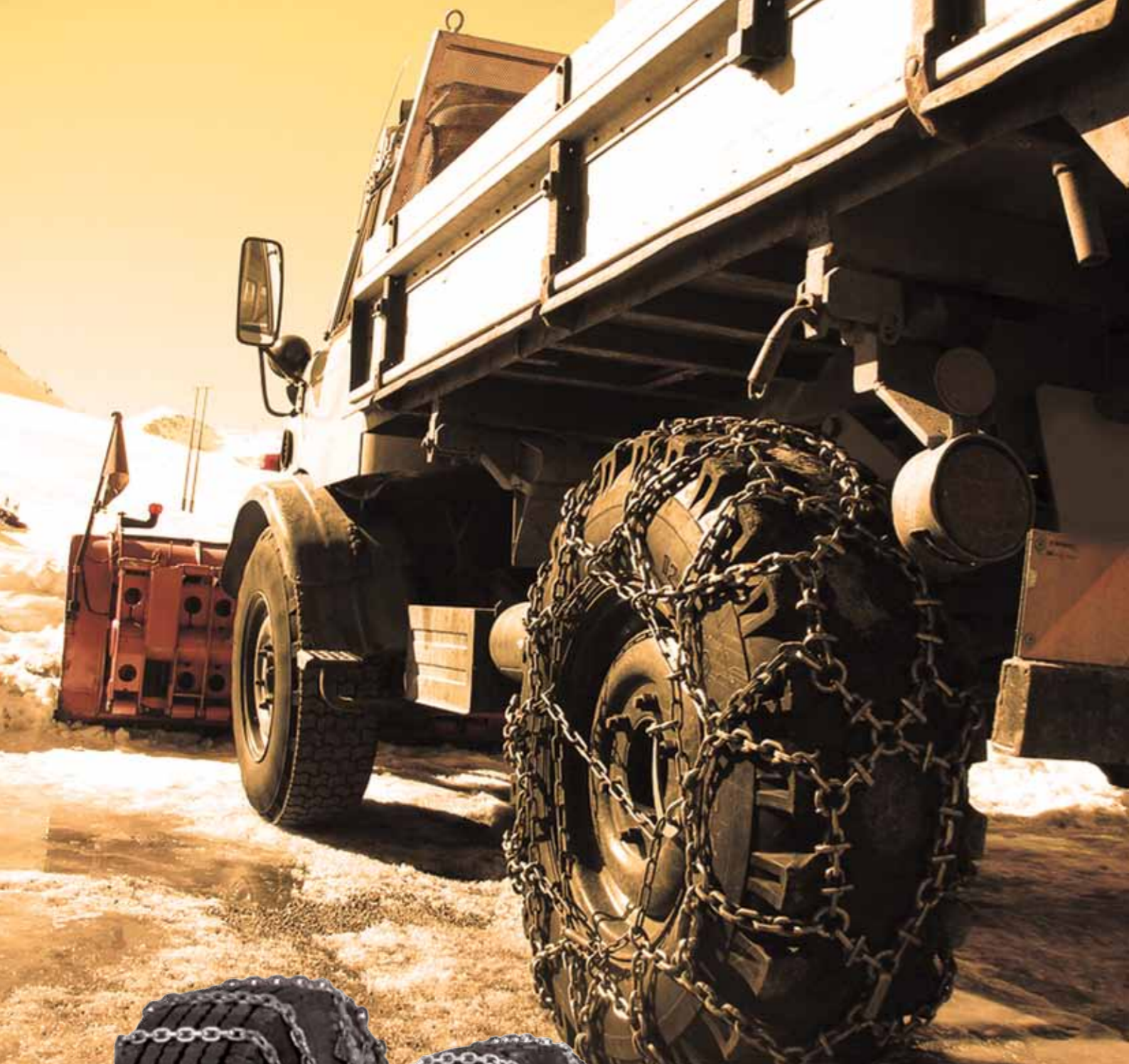

JEDNODELNI LANCI ZA SNEG

Poz.	Primena	RAPIDEX broj
1.	295/60 R22,5	OPRE0954
2.	315/60 R22,5	OPRE0953
3.	315/70 R22,5	OPRE0952
4.	315/80 R22,5	OSTA0198

TRODELNI LANCI ZA SNEG

Poz.	Primena				RAPIDEX broj
1.	205/75 R17,5 215/75 R17,5 225/75 R17,5 235/75 R17,5 7,00 R17,5 8,00 R17,5 8,50 R17,5 9,00 R17,5	7,00 R19,5 8,00 R19,5	6,50 R20		OPRE0357
2.	8,25 R17	245/70 R19,5 265/70 R19,5 275/70 R19,5 285/70 R19,5 9,00 R19,5 9,50 R19,5	7,50 R20 8,25 R20	225/70 R22,5 8,00 R22,5 9,00 R22,5	OPRE0112
3.	305/70 R19,5	9,00 R20	275/70 R22,5 295/70 R22,5 295/60 R22,5 305/60 R22,5 10,00 R22,5	9,50 R24	OPRE0358
4.	10,00 R20 11,00 R20 12,00 R20 12,5 R20 12/80 R20 13/80 R20	11,00 R22	11,00 R22,50 12,00 R22,5 13,00 R22,5 12/80 R22,5 275/80 R22,5 295/80 R22,5 315/80 R22,5 315/75 R22,5 305/70 R22,5 315/70 R22,5 315/60 R22,5	11.2 R24 305/75 R24,5 315/75 R24,5	OPRE0108

VUČNA KUKA AUTOMATSKA TIP 5055 A, DIN 74053, ISO 1102. D-50

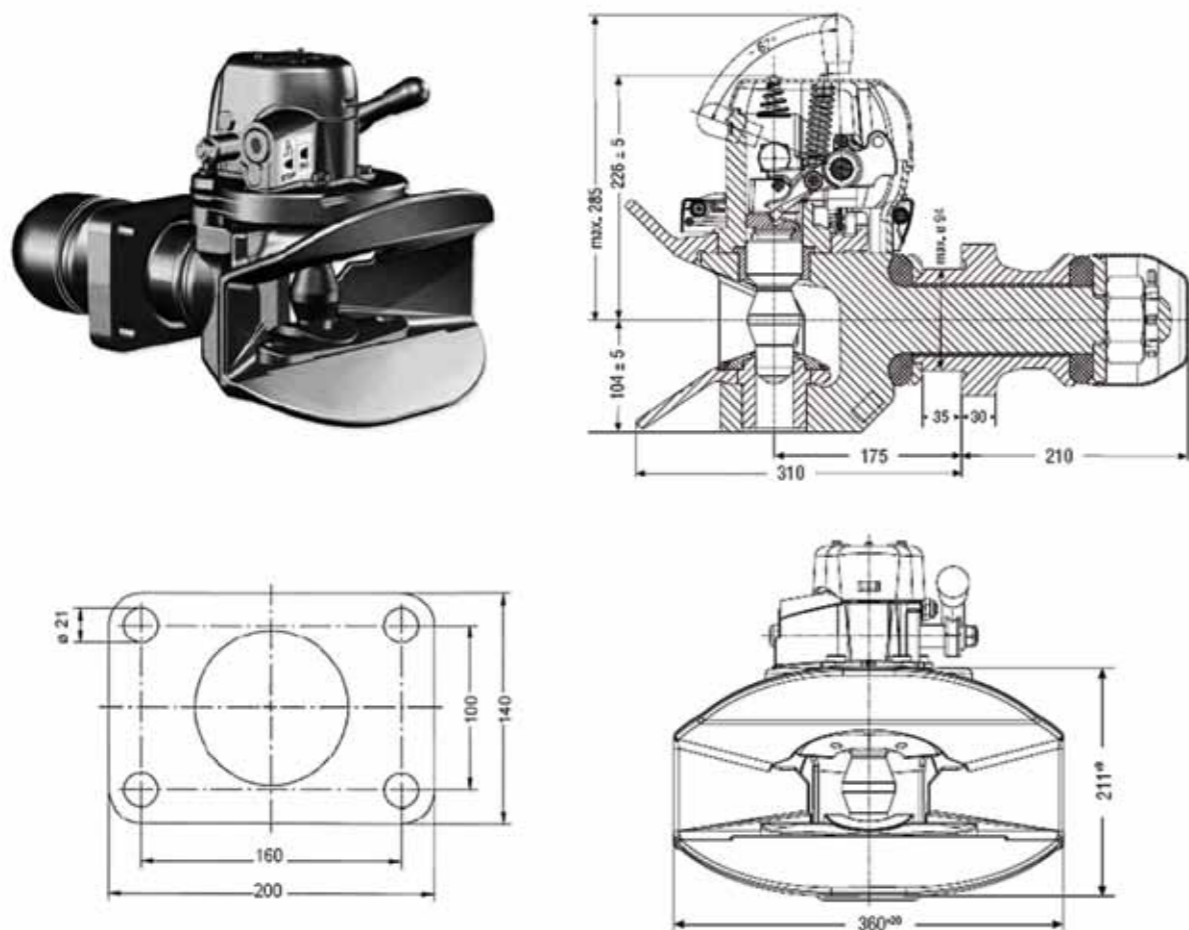

Tehničke karakteristike	Naziv	KBP	RAPIDEX broj
D = 200 kN DC = 135 kN V = 75/63 kN m = 50 kg	VUČNA KUKA	14 996 305	KARO0586
	GORNJA ČAURA	14 995 463	OPRE0237
	DONJA ČAURA	14 991 239	OPRE0236
	STOŽER	14 991 279	OPRE0238
	ZAŠTITNI LIM	14 991 255	OPRE0245

VUČNA KUKA AUTOMATSKA TIP 2045 G/145 G/150, DIN 74054, ISO 8755

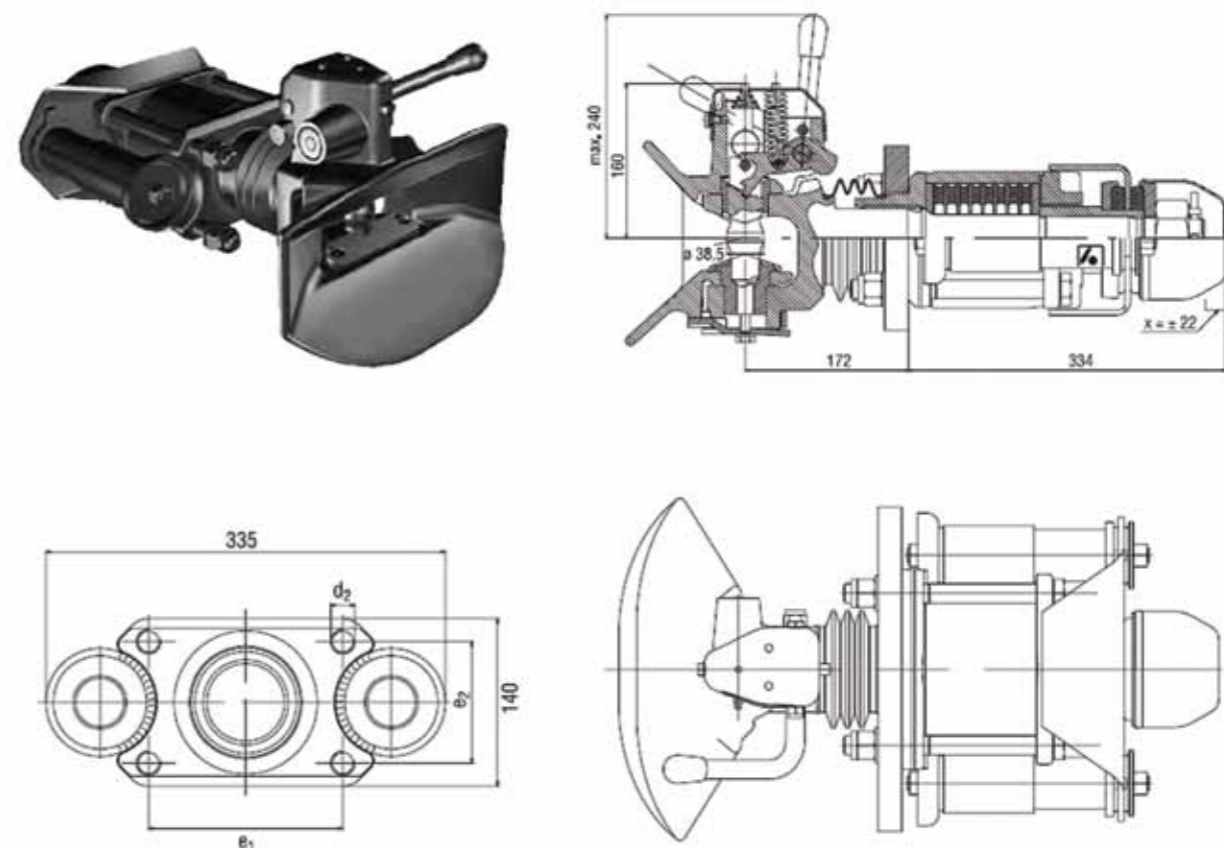

Tehničke karakteristike	Naziv	KBP	RAPIDEX broj
D = 100 kN G/145 D = 136 kN G/136 E1-G/145-140, G/150-160 E2-G/145-80, G/150-100	VUČNA KUKA	G/145 14 995 435	KARO0587
		G/150 14 995 447	KARO0651
	GORNJA ČAURA	6 997 899	OPRE0241
	DONJA ČAURA	6 997 880	OPRE0243
	STOŽER	12 991 452	OPRE0239

VUČNA KUKA AUTOMATSKA TIP 92/CX, DIN 74053, ISO 1102 D 50

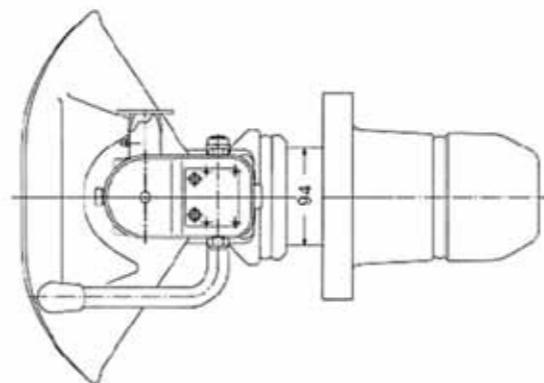
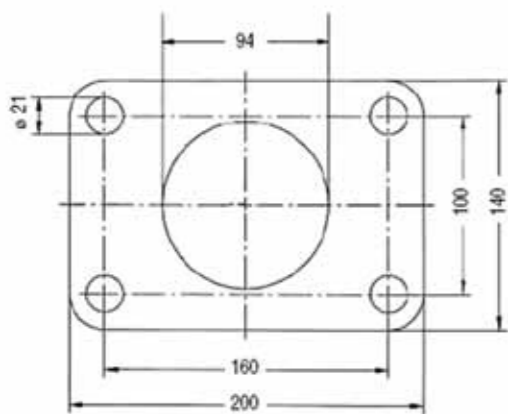
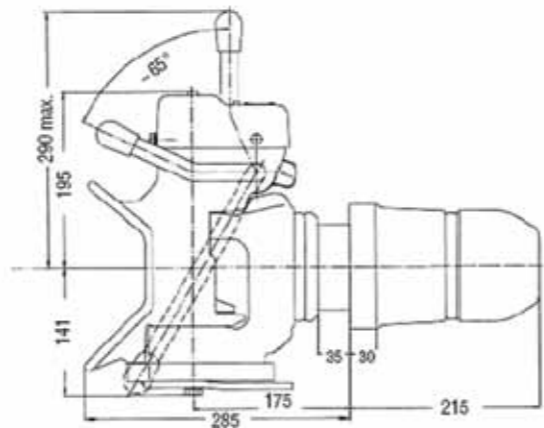

Tehničke karakteristike	Naziv	KBP	RAPIDEX broj
D = 190 kN DC = 130 kN V = 75 kN m = 50 kg	VUČNA KUKA	13 997 020	KARO0588
	GORNJA ČAURA	7 998 210	OPRE0242
	DONJA ČAURA	7 998 252	OPRE0244
	STOŽER	13 991 460	OPRE0240

AIR TOP 2000 ST



RAPIDEX broj:
HLAĐ0182





Napon (V)	Snaga (KW)	Potrošnja goriva (l/h)	Potrošnja energije (W)	Dimenzije (mm)	Težina uređaja (kg)
24	0,9 - 2,0	0,12 - 0,24	14 - 29	311 x 120 x 121	2,6

REZERVNI DELOVI - AIR TOP 2000 / 2000S / 2000ST

Poz.	Slika	Naziv / Opis	KBP	RAPIDEX broj
1.		GORIONIK AT 2000	65786A	HLAĐ0146
2.		MOTOR GREJČA AT 2000 / S	70678A	KABI0004
3.		SVEĆICA-GREJAČ AT 2000 / S	82307A	KABI0003
4.		SENZOR PLAMENA AT 2000	82306C	HLAĐ0178
5.		ZAPTIVKA AT 2000 / S / ST	1303517A	HLAĐ0751

REZERVNI DELOVI - AIR TOP 2000 / 2000S / 2000ST				
Poz.	Slika	Naziv / Opis	KBP	RAPIDEX broj
6.		PUMPA GORIVA	65210A	ELEK0505
7.		ELEKTRONIKA AT 2000	87453B	KABI1458
8.		GORIONIK AT 2000 ST	1302799	HLAĐ0656
9.		MOTOR GREJAČA AT 2000 ST N.TIP	1302788	HLAĐ0752
10.		MOTOR GREJAČA AT 2000 ST S.TIP	1303848A	ELEK1716
11.		SVEĆICA-GREJAČ AT 2000 ST	9005087A	HLAĐ0753

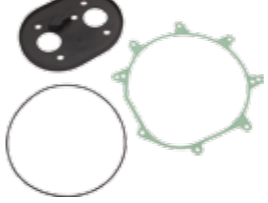

AIR TOP 3500 ST					
					RAPIDEX broj: HLAĐ0861
Napon (V)	Snaga (KW)	Potrošnja goriva (l/h)	Potrošnja energije (W)	Dimenzije (mm)	Težina uređaja (kg)
24	1,5 - 3,5	0,18 - 0,42	15 - 33	428 x 148 x 162	5,9

REZERVNI DELOVI - AIR TOP 3500 ST				
Poz.	Slika	Naziv / Opis	KBP	RAPIDEX broj
1.		GORIONIK AT 3500 ST	9004220A	KABI1451
2.		MOTOR GREJAČA AT 3500 ST	9005916A	HLAĐ0754
3.		SVEĆICA-GREJAČ AT 3500 ST	9004215	HLAĐ0755
4.		PUMPA GORIVA	65210A	ELEK0505
5.		GARNITURA ZAPTIVKI	1322643A	HLAĐ1040

AIRTRONIC D2

Poz.	KBP	Opis	RAPIDEX broj			
1.	252675050000	12 V KPL sa setom za montažu	KABI1698			
2.	252676050000	24 V KPL sa setom za montažu	KABI1697			
						
Kapacitet grejanja	W	2200	1800	1200	850	
Protok toplog vazduha	kg/h	105	90	60	40	
Potrošnja energije	W	34	22	12	8	
Potrošnja goriva	l/h	0,28	0,23	0,15	0,1	
Dimenzije uređaja	mm	310 x 115 x 122	-	-	-	
Težina uređaja	kg	2,7	-	-	-	

REZERVNI DELOVI - AIRTRONIC D2

Poz.	Slika	Naziv / Opis	KBP	RAPIDEX broj
1.		GORIONIK	252069100100	KABI1459
2.		ZAPTIVKA GORIONIKA	252069060001	KABI1465
3.		MOTOR GREJAČA	252070992000	KABI1460

REZERVNI DELOVI - AIRTRONIC D2

Poz.	Slika	Naziv / Opis	KBP	RAPIDEX broj
4.		ZAPTIVKA MOTORA GREJAČA	252069010003	KABI1456
5.		GREJAČ-SVEČICA	252070010300	KABI1464
6.		SITO SVEČICE KPL	252069100102	KABI1452
7.		SITO SVEČICE	252069100102	KABI1467
8.		PUMPA GORIVA	251908450000 1 - 3 kW	KABI1618
			224518010000 1 - 4 kW	KABI1461
9.		SENZOR PREGREVANJA	252069010200	KABI1866

AIRTRONIC D4S



RAPIDEX broj:
HLAĐ0186

Kapacitet grejanja	W	4000	3000	2000	900
Protok toplog vazduha	kg/h	185	140	100	55
Potrošnja energije	W	55	30	16	7
Potrošnja goriva	l/h	0,51	0,38	0,25	0,11
Dimenzije uređaja	mm	376 x 140 x 150	-	-	-
Težina uređaja	kg	4,5	-	-	-

REZERVNI DELOVI - AIRTRONIC D4/D4S

Poz.	Slika	Naziv / Opis	KBP	RAPIDEX broj
1.		GORIONIK	252113100100	KABI1462
2.		ZAPTIVKA GORIONIKA	252113060001	KABI1636
3.		MOTOR GREJAČA D4	252114992000	KABI1450
4.		MOTOR GREJAČA D4S	252145992000	KABI1642

REZERVNI DELOVI - AIRTRONIC D4/D4S

Poz.	Slika	Naziv / Opis	KBP	RAPIDEX broj
5.		ZAPTIVKA MOTORA GREJAČA	252113010003	KABI1463
6.		GREJAČ-SVEĆICA	252070010300	KABI1464
7.		SITO SVEĆICE KPL	252069100102	KABI1452
8.		SITO SVEĆICE	252069100102	KABI1467
9.		PUMPA GORIVA	251908450000 1 - 3 kW	KABI1618
			224518010000 1 - 4 kW	KABI1461
10.		SENZOR PREGREVANJA	252069010200	KABI1866

CREVA I CEVI GREJANJA				
Poz.	Slika	Opis	KBP	RAPIDEX broj
1.		Ø60 mm	1311898B	HLAĐ1063
		Ø75 mm	102114340000	HLAĐ1065
		Ø90 mm	1311902B	HLAĐ1064
2.		Ø24 mm 1m	95125	OSTA4466
		Ø24 mm 2m	95282	OSTA4613
		Ø30 mm 1m	95130	OSTA4614



Komercijalna Vozila

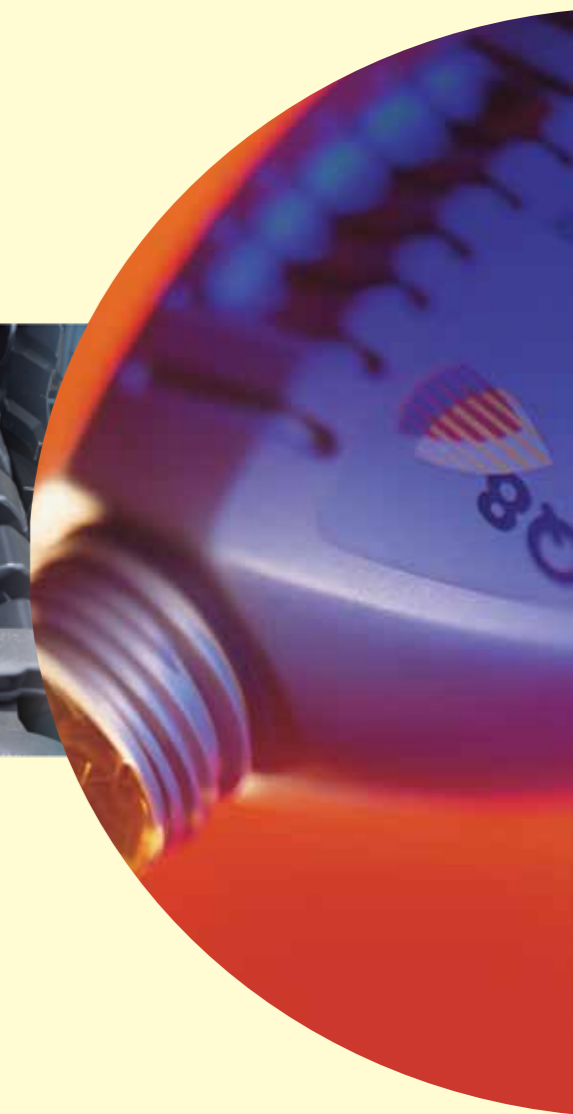

Uvod

Zaštita vašeg motora i ušteda goriva je uvek bila važna uloga Q8 motornih ulja. Zahvaljujući inovacijama, emisija od 25 kamiona danas je jednaka 1 kamionu od pre 30 godina. Da bi se produžio vek ovih motora i vek sistema za prečišćavanje izduvnih gasova, razvili smo novu liniju Q8 Oils maziva za teške dizel motore.

Trendovi

U skladu sa strogim propisima EU o emisiji gasova, svaki moderno dizajnirani kamion sadrži komponente kao što su katalizator, EGR i filtere protiv čađi. Kompanija Q8 Oils razvila je liniju maziva koja ovim komponentama dugoročno obezbeđuje da budu čisti. Time se ujedno smanjuju troškovi održavanja kao i veliki troškovi zamene zagađenih delova; na primer, naknadna ugradnja SCR sistema u proseku košta 7.000,00 EUR.

Naša tehnologija koja je ugrađena u proizvodima Q8 T 904, Q8 T 905, Q8 T 910 i Q8 T 760 obezbeđuje smanjenje vaših troškova održavanja.

Maziva koja obezbeđuju smanjenu potrošnju goriva postala su još privlačnija zato što u najnovijim EURO VI motorima za sve vrste kamiona odobreno je korišćenje ulja sa niskim nivoom gustine, što ujedno predstavlja i za vas priliku da sačuvate novac i garanciju. Maziva koja preporučujemo za smanjenu potrošnju goriva su sledeća: Q8 T 910 5W-30, Q8 T 904 FE 10W-30, Q8 T 760 10W-30 and Q8 SuperTruck FE 5W-30.



Motorna ulja za transportna vozila

Za dugi servisni interval potrebna su ulja visokog kvaliteta, kao što su Q8 T 904 FE ili Q8 T 910.

Rešenje koje pruža kompanija Q8 Oils

U niže navedenoj tabeli prikazani su proizvodi Q8 motorna ulja koja se preporučuju prema vrsti kamiona. SAPS kateorija (Sulphated Ash Phosphorous Sulphur) namenjena za sisteme pročišćavanja izduvnih gasova je specificirana od strane proizvođača kamiona. Izborom Q8 maziva, možete da preferirate između uštede ulja ili periode zamene ulja.

			Ekonomična potrošnja	Osobine pri paljenju hladnog motor	Period zamene ulja						
					DAF	MAN	Mercedes	Volvo	Renault	Iveco	Scania
NISKA VREDNOST PEPELA	Q8 T 904	10W-40	★★	★★	Long Drain	Long Drain	Long Drain	Medium Drain	Medium Drain	Long Drain (*)	-
	Q8 T 905	10W-40	★★	★★★	Long Drain	Long Drain	Long Drain	Medium Drain	Medium Drain	Long Drain (*)	Medium Drain (**)
	Q8 T 904 FE	10W-30	★★★	★★★	Long Drain	Long Drain	Long Drain	Medium Drain	Medium Drain	Long Drain (*)	-
	Q8 T 910	5W-30	★★★★	★★★★	Long Drain	Long Drain	Long Drain	Medium Drain	Medium Drain	Long Drain (*)	-
SREDNJA VREDNOST PEPELA	Q8 T 760	15W-40	*	★★	Medium Drain	Medium Drain	Medium Drain	Long Drain	Long Drain	-	Short Drain (***)
	Q8 T 760	10W-30	★★★	★★★	Medium Drain	Medium Drain	Medium Drain	Long Drain	Long Drain	-	Short Drain (***)
VISOKA VREDNOST PEPELA	Q8 T 860 S	10W-40	★★	★★★	Long Drain	Long Drain	Long Drain	Long Drain	Long Drain	Long Drain	Long Drain (***)
	Q8 Super Truck FE	5W-30	★★★★	★★★★	Long Drain	Long Drain	Long Drain	Long Drain	Long Drain	Long Drain	Long Drain

(*) od Iveco generacije EURO VI
 (**) EURO VI Scania motori
 (***) Scania motori sa DPF filterom

NISKA VREDNOST PEPELA	Q8 T 910	5W-30	FUEL saver	Dizajnirano za uštedu goriva, mazivo niskog viskoziteta sa odličnim osobinama pri paljenju hladnih motora za skoro sve vrste Euro IV, V i VI dizel motora. Ovo sintetičko ulje sa odličnim performansama i SAPS tehnologijom niske vrednosti razvijeno je specijalno za komercijalna vozila sa dizel filterom za čišćenje čestica (DPF).
	Specifikacije:	ACEA E6/E7; API CI-4		
	Odobrenja:	MAN 3477; MB 228.51; VOLVO VDS-3; RENAULT RLD-2; MACK EO-N		
Q8 Oils preporuke:		DEUTZ DQC IV-10 LA; MACK EO-M PLUS; MTU TYP-3.1; RENAULT VI RGD/RXD; VOLVO CNG		
NISKA VREDNOST PEPELA	Q8 T 905	10W-40		Sintetičko motorno ulje visokih performansi za teške uslove rada sa niskom vrednošću SAPS-a. Dizajniran je za podmazivanje velikog broja Euro IV, V i VI dizel motora opremljenih sa filterom za čišćenje čestica (DPF) ili katalizatorom (kao SCR) i radi na dizel gorivu sa malo sumpora i pod teškim uslovima. Takođe odgovara i Euro III motorima. Q8 T 905 ima odlična svojstva pri paljenju hladnih motora.
	Specifikacije:	ACEA E6/E7/E9; API CI-4;		
	Odobrenja:	DEUTZ DQC III-10 LA; MACK EO-N; MAN 3477; MB 228.51; MTU TYP-3; RENAULT VI RLD-2; SCANIA Low Ash; VOLVO VDS-3		
Q8 Oils preporuke:		CUMMINS CES 20076/77; DAF; MACK EO-M PLUS; MB 226.9; MTU TYP 3.1; RENAULT VI RGD, RXD; VOLVO CNG; MAN 3271-1; CATERPILLAR ECF-1a		
NISKA VREDNOST PEPELA	Q8 T 904 FE	10W-30	FUEL saver	Dizajniran za štednju goriva, mazivo niskog viskoziteta za skoro sve Euro IV, V i VI dizel motore. Sintetičko motorno ulje visokih performansi za teške uslove rada sa niskom vrednošću SAPS-a.
	Specifikacije:	ACEA E6,E7; API CI-4		
	Odobrenja:	MAN M3477; MB 228.51; VOLVO VDS-3; RENAULT VI RLD-2; MACK EO-N		
Q8 Oils preporuke:		DAF; CUMMINS CES 20076/77; DEUTZ DQC III-10 LA		
NISKA VREDNOST PEPELA	Q8 T 904	10W-40		Sintetičko motorno ulje visokih performansi za teške uslove rada sa niskom vrednošću SAPS-a dizajniran je za podmazivanje skoro svih Euro IV, V i VI dizel motora.
	Specifikacije:	ACEA E6 /E7; API CI-4		
	Odobrenja:	MAN M3477; MB 228.51; MTU Type 3.1; RENAULT VI RLD-2; VOLVO VDS-3; MACK EO-N; DEUTZ DQC III-10 LA		
Q8 Oils preporuke:		DAF; CUMMINS CES 20076/77		
SREDNJA VREDNOST PEPELA	Q8 T 760	15W-40 10W-30	FUEL saver	SHPD (Super High Performance Diesel) dizel motorno ulje sa niskom vrednošću sulfatnog pepela i ograničenom vrednošću fosfora i sumpora, namenjeno za motore koji su u skladu sa Euro V standardom i Američkim EPA 2007 zahtevima za izduvne gasove. Pogodno je za duge intervale zamene ulja i za vozila opremljena sa filterima za čišćenje čestica i katalizatorima (npr. SCR). Q8 T 760 SAE 15W-40 takođe može da se koristi i za Euro II i III dizel motore. Q8 T 760 SAE 10W-30 je ulje koje štedi gorivo, niskog viskoziteta i nije pogodan za starije motore.
	Specifikacije:	ACEA E9; API CJ-4/API SN; CATERPILLAR ECF-1a/ECF-2/ECF-3		
	Odobrenja:	MACK EO-O PREMIUM PLUS; MAN 3575; MB228.31; RENAULT VI RLD-3; VOLVO VDS-4		
Q8 Oils preporuke:		CUMMINS CES 20081; DDC 93K218; DEUTZ DQC III-10; MAN 3275; MTU TYPE 2.1		
VISOKA VREDNOST PEPELA	Q8 T 860 S	10W-40		Dizel motorno ulje sa izuzetno visokim performansama koje se sastoji od sintetičkih baznih ulja. Razvijeno je motore kompanije Scania koja dozvoljava zamenu ulja na 120.000 km. Na tržištu je dostupno od marta 2013.
	Specifikacije:	ACEA E4/E7; API CF		
	Odobrenja:	SCANIA LDF-3		
Q8 Oils preporuke:		VOLVO VDS-3; MB 228.5; MAN 3277; RENAULT RLD-2		
VISOKA VREDNOST PEPELA	Q8 SuperTruck FE	5W-30	FUEL saver	Dizajnirano za uštedu goriva, mazivo niskog viskoziteta sa odličnim osobinama pri paljenju hladnih motora za skoro sve vrste Euro III i neke vrste Euro IV i V i dizel motora. Ovo je UHPD (Ultra High Performance Diesel) sintetičko dizel motorno ulje sa izuzetno visokim performansama koje omogućava produženi interval zamene ulja.
	Specifikacije:	ACEA E4/E7		
	Odobrenja:	MAN 3277; MB 228.5;		
Q8 Oils preporuke:		IVECO; CUMMINS CES 20071/72/76/77; MACK EO-M PLUS; MB 235.28; MTU TYPE-3; SCANIA LDF; VOLVO VDS-3		

VISOKA VREDNOST PEPELA	Q8 T 860	10W-40	UHPD dizel motorno ulje sa izuzetno visokim performansama na sintetičkoj bazi namenjeno je za skoro sve Euro III i pojedine Euro IV i V dizel motore. ACEA E4 specifikacija garantuje visok nivo čišćenja čađi u motoru.
	Specifikacije:		ACEA E4/E7; API CI-4
	Odobrenja:		CUMMINS CES 20077/78; DEUTZ DQC III-05; MACK EO-M PLUS; MAN 3277; MB 228.5; MTU TYPE-3; SCANIA LDF-2; TEDOM 258-3; VOLVO VDS-3
	Q8 Oils preporuke:		DAF; JASO DH-1; RENAULT VI RXD/RLD-2; VOITH RETARDER KLASSE A
VISOKA VREDNOST PEPELA	Q8 T 800	10W-40	Polu-sintetičko dizel motorno ulje visokih performansi namenjeno je za Euro III i Euro IV motore sa niskom emisijom izduvnih gasova, koje omogućava i smanjenje potrošnje goriva. Takođe je pogodno za dizel motore putničkih automobila i manje motore sa direktnim ubrizgavanjem.
	Specifikacije:		ACEA E7/B4/A3; API CI-4/SL
	Odobrenja:		MACK EO-N; MAN 3275; RENAULT VI RLD-2; TEDOM 258-3; VOLVO VDS-3, DEUTZ DQC III -10; MTU TYP-2
	Q8 Oils preporuke:		CUMMINS CES 20071/72/76/77/78; MACK EO-M PLUS; MB 228.3; MB 229.1; GLOBAL DHD-1; CATERPILLAR ECF-1/ECF-2
VISOKA VREDNOST PEPELA	Q8 T 750	15W-40	Q8 T 750 može da se koristi za sve četvorotaktne dizel motore sa gorivom koje ima malu vrednost sumora (<0.05 %) i za motore kamoiona, kao i za motore poljoprivrednih i industrijskih radilica koje rade pod teškim uslovima. Takođe može da se koristi kod benzinskih i dizel motora putničkih automobila.
	Specifikacije:		ACEA E7/B4/A3; API CI-4/SL;
	Odobrenja:		DEUTZ III-10; MACK EO-N PLUS; MAN 3275; VOLVO VDS-3; MB 228.3; MTU TYPE-2; RENAULT VI RLD, RLD-2; ZF TE-ML 04C/07C; CUMMINS 20071/72/76/77
	Q8 Oils preporuke:		MB 229.1; GLOBAL DHD-1; CATERPILLAR ECF-1/ECF-2



Ulja za menjače i osovine kod komercijalnih vozila

Kod savremenih menjača i osovina, od suštinskog značaja su dobra zaštita od trenja i termička stabilnost, da bi se postigao što duži servisni interval. Ulja za menjače imaju i veliki uticaj na potrošnju goriva. Kao na primer Q8 T 60Ntech u menjaču i Q8 T 66 u zadnjoj osovini.

	GL-4	GL-5	mil-prf 2104e	Synth. Base Oil Components	Long Drain	Fuel Economy	Drive Line = Gear Box + Rear Axle	Intarder Suited	DAF	Iveco	MAN	Mercedes	Renault	Scania	Volvo
MENJAC	Q8 Gear Oil XG	✓	✓	-	-	*	✓	-	-	-	✓	-	-	✓	-
	Q8 T60Ntech	-	-	-	**	**	-	✓	✓	✓	✓	-	✓	-	-
	Q8 Supergear S	GL-3	-	-	***	**	**	-	-	-	-	-	-	-	✓
	Q8 T 36	✓	-	-	***	***	*	-	-	-	-	✓	-	-	-
ZADNJA OSOVINA	Q8 Axle Oil XG	✓	✓	✓	-	*	✓	-	✓	✓	-	-	-	✓	-
	Q8 Trans XGS	✓	✓	✓	***	***	**	✓	✓	✓	✓	✓	-	-	-
	Q8 T 65	-	✓	-	***	***	**	-	-	-	-	-	-	-	✓
	Q8 Unigear GL-5	-	✓	-	**	**	**	-	-	-	-	-	-	-	✓
	Q8 T 66	✓	✓	✓	***	***	***	-	✓	✓	✓	✓	-	✓	✓

MENJAC	Q8 Gear Oil XG	80W-90	Q8 Gear Oil XG je automotivno univerzalno menjačko ulje za sinhronizovane i nesinhronizovane manualne menjače, osovine i sve komponente koje prenose snagu (od motora do zadnje osovine) i koje zahtevaju API GL-4/GL-5 nivo performansi. Odobreno je od strane kompanije Scania za servisni interval do 180.000 km.
	Specifikacije: Odobrenja:		API GL-4; API GL-5 SCANIA STO 1:0; SAE J 2360 (PRI GL 0208); MAN 341 E2/Z2, 342 M2; ZF TE-ML 02B/05A/12E
MENJAC	Q8 T 60 Ntech	75W-80	Q8 T 60 Ntech je ulje na sintetičkoj bazi za manualne menjače sa visokim performansama koji zahtevaju specijalne osobine tečnosti na niskim i visokim temperaturama, što rezultuje da se lakše menjaju brzine.
	Odobrenja: Q8 Oils preporuke:		ZF TE ML 02L MAN 341 Z3/E3/Z4; VOLVO 97305; ZF TE-ML 01L
MENJAC	Q8 SuperGear S	75W-80	Q8 SuperGear S je sintetičko ulje sa najnovijom tehnologijom aditiva za manualne menjače. Može se koristiti kao višenamensko ulje za manualne menjače kod kamiona, autobusa i putničkih automobila.
	Specifikacije: Q8 Oils preporuke:		API GL-3; VOLVO 97305 JOHN DEERE JDM J11C; VOLVO 97307
MENJAC	Q8 SuperGear V	75W-80	Q8 SuperGear V je sintetičko ulje razvijeno za Volvo manualne menjače. Može se koristiti kao ulje za manualne menjače u kamionima i autobusima.
	Specifikacije: Odobrenja: Q8 Oils preporuke:		API GL-4 VOLVO 97307 MAN 341 ZE-VR (former MAN 341 SL); VOITH RETARDER OIL CLASS C; EATON S SERIES TRANSMISSIONS
MENJAC	Q8 T 36	75W-90	Q8 T 36 je potpuno sintetičko ulje za "switch gear" menjače sa najvišim performansama koji zahtevaju posebna svojstva tečnosti na visokim i niskim temperaturama i time poboljšavaju prenos. Proizvod je razvijen specijalno za komercijalna vozila marke Mercedes.
	Specifikacije: Odobrenja:		API GL-4 MAN 342 TYP MB; MB 235.11
ZADNJA OSOVINA	Q8 Axle Oil XG	80W-140	Automotivno ulje koje je namenjeno za osovine i diferencijale. Odobreno je od strane kompanije Scania za servisni interval do 180.000 km.
	Specifikacije: Odobrenja: Q8 Oils preporuke:		API GL-4/GL-5; MIL-PRF-2105 E SCANIA STO 1:0; ZF TE-ML 05A/12E/16D/21A ZF TE-ML 02B
ZADNJA OSOVINA	Q8 Trans XGS	75W-90	Sintetičko automotivno ulje za zadnje osovine, diferencijale i pojedine manualne menjače koji rade pod teškim uslovima i koji zahtevaju posebne osobine tečnosti pri niskim temperaturama da bi se dobila niža potrošnja goriva i lakša promena brzina.
	Specifikacije: Odobrenja: Q8 Oils preporuke:		API GL-4/GL-5; MIL-PRF-2105-E MAN 341 E3/Z2, 342 M3; SCANIA STO 1:0; ZF TE-ML 02B/5A/12B MAN 342 S1
ZADNJA OSOVINA	Q8 T 65	75W-90	Sintetičko ulje za menjače koje pruža kombinaciju dobrih osobina tečnosti na niskim i visokim temperaturama. Time se smanjuje trenje i samim tim smanjuje se i buka prenosa i potrošnja goriva.
	Specifikacije: Odobrenja: Q8 Oils preporuke:		API GL-5 VOLVO 97312; ZF TE-ML 17B/19B ZF TE-ML 05A
ZADNJA OSOVINA	Q8 Unigear GL-5	75W-90	Automotivno ulje na sintetičkoj bazi namenjeno je za manualne menjačime i osovine u putničkim i komercijalnim vozilima.
	Specifikacije: Q8 Oils preporuke:		API GL-5; MIL-L-2105D ZF TE-ML 05A
ZADNJA OSOVINA	Q8 T 66	75W-110	Razvijen u cilju postizanja značajne uštede goriva za osovine u kamionima koji rade pod velikim opterećenjem. Relativno novi viskozitet SAE 110 se koristi radi postizanja optimalnog podmazivanja. Ovo sintetičko ulje je za podmazivanje visoko opterećenih komponenta, kao što su zadnje osovine, diferencijali i pojedini menjači. Potvrđeno je da Q8 T 66 smanjuje potrošnju goriva do 4,7 %.
	Specifikacije: Q8 Oils preporuke:		API GL-4/GL-5; API MT-1; MIL-PRF-2105E; SAE J 2360 ZF TE-ML-05B/12B; MACK GO-J; MB 235.8; MAN 341 S1; SCANIA STO 1:0





Ulja za automatske menjače u komercijalnim vozilima

Q8 Auto 14

Ulje za automatske menjače koje takođe odgovara za servo volane i kao hidraulično ulje.

Q8 Oils preporuke:

MB 236.7; VME; ZF TE-ML 14A; VOITH 55.6335.3X

Q8 Auto 15 ED

Q8 Auto 15 ED je ulje na sintetičkoj bazi za automatske menjače koje takođe odgovara za servo volane i kao hidraulično ulje.

Q8 Oils preporuke:

VOITH DIWA H55.6336.3X; ZF TE-ML 14B



Hidraulična ulja za komercijalna vozila

Q8 Haydn

10, 15,
22, 32,
46, 68,
100, 150

Univerzalno hidraulično ulje za višenamensku upotrebu sa indeksom viskoziteta vrednosti 100. Bazno ulje ima dobar prirodni otpor starenju (oskidaciji) i ujedno veoma svetlu boju. Ovo se lako filtrira.

Važeći za sledeće primene:

AFNOR 48-603, CATEGORY HM; MAG IAS P-68/P-69/P-70; DENISON HF-0/HF-1/HF-2; DIN 51524 PART 2, CATEGORY HLP; ISO 11158, CATEGORY HM; SS 155434, CATEGORY AM

Q8 Heller

15, 22,
32, 46,
68, 100

Q8 Heller je mineralno hidraulično ulje tipa HVLP sa izuzetno visokim indeksom viskoziteta, vrednosti 150. Q8 Heller je idealno za upotrebu u hidrauličnim sistemima koje rade u uslovima velikih temperaturnih promena. Optimalni viskozitet pri pokretanju u hladnim uslovima obezbeđuje neometani rad hidrauličnih sistema. Koristi se za kopačice i ostale mašine koje rade u spoljnim uslovima. Q8 Heller odgovara zahtevima većine proizvođača džipova.

Važeći za sledeće primene:

AFNOR 48-603, CATEGORY HV; DIN 51524 PART 3, CATEGORY HVLP; ISO 11158, CATEGORY HV



Masti za komercijalna vozila

Q8 Rembrandt EP 2

NLGI 2

Višenamenska litijumska mast unapređena sa aditivima koji poboljšavaju osobine otpornosti pri visokom pritisku i oksidaciji; takođe sadrži i inhibitor rđanja.

Veličina pakovanja:

50kg KEG, 12.5kg, 180kg, 12 x 400g (CART)

Q8 Rembrandt Moly

NLGI 2

Visoko kvalitetna višenamenska litijumska mast koja sadrži molibdenski disulfid koji obezbeđuje dodatnu zaštitu od trenja. Sadrži inhibitor rđanja i additive protiv oksidiranja.

Veličina pakovanja:

50kg KEG, 12.5kg, 180kg, 12 x 400g (CART)

Q8 Rembrandt EP 00 WV

NLGI 00

Litijumska mast za centralne sisteme podmazivanja marke Willy Vogel preporučuje se za upotrebu kada se zahtevaju specifikacije MB 264 i MAN 283. Specijalno za automotivne aplikacije gde je potrebno lako pumapanje pri niskim temperaturama.

Veličina pakovanja:

12.5kg, 50kg KEG, 12.5kg

Q8 Rubens WB Blau

NLGI 2

Višenamenska litijumska kompleksna mast za ležajeve u kamionima i prikolicama gde je potrebno lako pumapanje u centralnim sistemima za podmazivanje a zahteva se NLGI 2 mast.

Veličina pakovanja:

50kg KEG, 12.5kg, 12 x 400g (CART)



Ostali proizvodi

Q8 Brake Fluid DOT 4

Nepetrolejska kočiona tečnost sa osobinom stvaranja niskog parnog pritiska. Pogodna je za korišćenje u hidrauličnim sistemima kočnica i kvačila u svim putničkim automobilima, kamionima, autobusima i prikolicama gde se traže proizvodi visokih performansi. Ovaj proizvod se posebno preporučuje za funkcionisanje pri visokim temperaturama koje se stvaraju od kočionih diskova ili kada postoji dodatno opterećenje na kočionom sistemu.

Q8 Oils preporuke:

FMVSS 116 DOT 3; FMVSS 116 DOT 4; SAE J1703

Veličina pakovanja:

50kg KEG, 12.5kg, 180kg, 12 x 400g (CART)

Q8 Antifreeze Long Life

Univerzalni koncentrat antifrizna visokih performansi koji daje zaštitu tokom cele godine kao rashladna tečnost leti i antifriz zimi. Baziran je na etilen glikolu, hemijski stabilan i ne podleže koroziji.

Q8 Oils preporuke:

BS 6580, 5177; SAE J 1034; ASTM D 3306; FVV Heft R 443; MAN 324 TYPE SNF

Veličina pakovanja:

1L, 5L, 25L, 205L

Q8 Degreasing Fluid HFB

Višenamenski odmašivač koji se ispira vodom.

Veličina pakovanja:

25L, 208L

Q8 Oils

MOTORNO ULJE	Q8 T 905	208 litara	RAPIDEX BROJ - ULJA0171
	Q8 T 905	60 litara	RAPIDEX BROJ - ULJA0129
	Q8 T 905	20 litara	RAPIDEX BROJ - ULJA0130

MOTORNO ULJE	Q8 T 904	208 litara	RAPIDEX BROJ - ULJA0313
	Q8 T 904	20 litara	RAPIDEX BROJ - ULJA0312
	-	-	-

MOTORNO ULJE	Q8 T 860 S	208 litara	RAPIDEX BROJ - ULJA0306
	Q8 T 860 S	20 litara	RAPIDEX BROJ - ULJA0307
	-	-	-

MOTORNO ULJE	Q8 T 860	208 litara	RAPIDEX BROJ - ULJA0135
	Q8 T 860	60 litara	RAPIDEX BROJ - ULJA0128
	Q8 T 860	20 litara	RAPIDEX BROJ - ULJA0127
	Q8 T 860	5 litara	RAPIDEX BROJ - ULJA0157

MOTORNO ULJE	Q8 T 800	1000 litara	RAPIDEX BROJ - ULJA0185
	Q8 T 800	208 litara	RAPIDEX BROJ - ULJA0158
	Q8 T 800	60 litara	RAPIDEX BROJ - ULJA0193
	Q8 T 800	20 litara	RAPIDEX BROJ - ULJA0159
	Q8 T 800	5 litara	RAPIDEX BROJ - ULJA0160
	-	-	-

MOTORNO ULJE	Q8 T 760	208 litara	RAPIDEX BROJ - ULJA0171
	Q8 T 760	20 litara	RAPIDEX BROJ - ULJA0129
	-	-	-

MOTORNO ULJE	Q8 T 750	208 litara	RAPIDEX BROJ - ULJA0136
	Q8 T 750	60 litara	RAPIDEX BROJ - ULJA0146
	Q8 T 750	20 litara	RAPIDEX BROJ - ULJA0145
	Q8 T 750	5 litara	RAPIDEX BROJ - ULJA0194

MOTORNO ULJE	Q8 T 520	208 litara	RAPIDEX BROJ - ULJA0161
	Q8 T 520	20 litara	RAPIDEX BROJ - ULJA0162
	-	-	-

ANTIFRIZ	G12 + KONCENTRAT	208 litara	RAPIDEX BROJ - HLA00648
	G12 + KONCENTRAT	20 litara	RAPIDEX BROJ - HLA00647
	-	-	-

MAST	Q8 REMBRANT EP2	192 kilograma	RAPIDEX BROJ - ULJA0246
	Q8 REMBRANT EP2	18 kilograma	RAPIDEX BROJ - ULJA0203
	Q8 REMBRANT EP2	5 kilograma	RAPIDEX BROJ - ULJA0183
	Q8 REMBRANT EP2	0,4 kilograma	RAPIDEX BROJ - ULJA0167
	Q8 RUBENS 00	18 kilograma	RAPIDEX BROJ - ULJA0184
	Q8 RUBENS WB/b	0,4 kilograma	RAPIDEX BROJ - ULJA0166

ULJE ZA KOČNICE I AUTOMATSKJE MENJAČE	Q8 BRAKE FLUID DOT4	0,25 litara	RAPIDEX BROJ - ULJA0163
	Q8 AUTO 15 ATF	20 litara	RAPIDEX BROJ - ULJA0182
	Q8 AUTO 15 ATF	1 litra	RAPIDEX BROJ - ULJA0165
	Q8 LHM MINERALNO ULJE	1 litra	RAPIDEX BROJ - ULJA0164
	-	-	-

HIDROL	Q8 HAYDN 10	208 litara	RAPIDEX BROJ - ULJA0240
	Q8 HAYDN 32	208 litara	RAPIDEX BROJ - ULJA0218
	Q8 HAYDN 46	208 litara	RAPIDEX BROJ - ULJA0212
	Q8 HAYDN 46	20 litara	RAPIDEX BROJ - ULJA0215
	Q8 HAYDN 68	208 litara	RAPIDEX BROJ - ULJA0213
	Q8 HAYDN 68	20 litara	RAPIDEX BROJ - ULJA0216
	Q8 HELLER 46	208 litara	RAPIDEX BROJ - ULJA0214
	Q8 HELLER 68	208 litara	RAPIDEX BROJ - ULJA0191
	-	-	-

ULJE ZA MENJAČ I DIFERENCIJAL	Q8 T 60	75W-80	60 litara	RAPIDEX BROJ - ULJA0238
	Q8 T 60	75W-80	20 litara	RAPIDEX BROJ - ULJA0241
	Q8 T 36	75W-90	208 litara	RAPIDEX BROJ - ULJA0237
	Q8 T 65	75W-90	60 litara	RAPIDEX BROJ - ULJA0180
	Q8 T 65	75W-90	20 litara	RAPIDEX BROJ - ULJA0178
	Q8 T 35	80W	20 litara	RAPIDEX BROJ - ULJA0143
	Q8 T 55	80W-90	208 litara	RAPIDEX BROJ - ULJA0200
	Q8 T 55	80W-90	60 litara	RAPIDEX BROJ - ULJA0199
	Q8 T 55	80W-90	20 litara	RAPIDEX BROJ - ULJA0139
	Q8 T 55	80W-90	1 litra	RAPIDEX BROJ - ULJA0188
	Q8 T 55	85W-140	20 litara	RAPIDEX BROJ - ULJA0181



NOVI SAD

Novosadski put 160
21000 Novi Sad
Srbija

Tel./Fax.

021 651 0521
021 651 0522
021 651 0523
021 651 1228
021 651 2254
060 824 8801

e-mail: office@rapidex.co.rs

BEOGRAD

Milošev kladenac BB

Tel./Fax.

011 406 59 48
011 406 67 82
011 406 67 83
060 824 8804

PARAĆIN

Carice Milice 54

Tel./Fax.

035 8 567 611
035 8 567 671
060 824 8833

ČAČAK

Konjevići bb

Tel.

032 559 0037
060 824 8821

LOZNICA

Bulevar Dositeja Obradovića 70

Tel.

015 877 883
015 877 884
060 824 8810

NOVI PAZAR

Save Kovačevića 300

Tel.

020 315 156,
060 824 8824

VRANJE

Ivana Meštrovića 27

Tel.

017 410 088
060 824 8835

office@rapidex.co.rs

www.rapidex.co.rs

SOMBOR

XII Vojvodanske udarne
brigade 130

Tel.

025 461 481
060 824 8850

SUBOTICA

Beogradski put 21

Tel.

024 556 246
060 824 8862

VRBAS

Ivana Milutinovića 11

Tel.

021 700 087
060 824 8806

NIŠ

Bulevar 12. Februar 152

Tel./Fax.

018 585 824
060 824 8874



BIJELJINA RAPIDEX DOO

Pantelinska 1

Tel./Fax.

+387 55 247 687

