KATALOG REZERVNIH DELOVA ZA KOMERCIJALNA VOZILA



IVECO
2016



ISO 9001:2008
valid until
04.09.2016
www.iveco.com
0 9994274

KATALOG REZERVNIH DELOVA ZA KOMERCIJALNA VOZILA



www.rapidex.co.rs

IVECO

2016





NOVI SAD

Novosadski put 160
21000 Novi Sad
Srbija

Tel./Fax.

021 651 0521
021 651 0522
021 651 0523
021 651 1228
021 651 2254
060 824 8801

e-mail: office@rapidex.co.rs



BEOGRAD

Milošev kladenac BB

Tel./Fax.

011 406 59 48
011 406 67 82
011 406 67 83
060 824 8804





PARAĆIN

Carice Milice 54

Tel./Fax.
035 8 567 611
035 8 567 671
060 824 8833



ČAČAK

Konjevići bb

Tel./Fax.
032 559 0037
060 824 8821





LOZNICA

Bulevar Dositeja Obradovića 70

Tel.

015 877 883
015 877 884
060 824 8810



SUBOTICA

Beogradski put 21

Tel.

024 556 246
060 824 8862



NOVI PAZAR

Save Kovačevića 300

Tel.

020 315 156
060 824 8824



VRBAS

Ivana Milutinovića 11

Tel.

021 700 087
060 824 8806



VRANJE

Ivana Meštrovića 27

Tel.

017 410 088
060 824 8835



NIŠ

Bulevar 12. Februar 152

Tel./Fax.

018 585 824
060 824 8874



SOMBOR

XII Vojvodanske udarne brigade 130

Tel.

025 461 481
060 824 8850



BIJELJINA

RAPIDEX DOO

Pantelinska 1

Tel./Fax.

+387 55 247 687

WABCO



NARVA





SADRŽAJ:

1.0 MOTOR

1.1	Delovi motora	18
1.2	Pumpe vode	22
1.3	Termostati	23
1.4	Španeri motora i prenosni kaiševi	24
1.5	Turbo kompresori	27
1.6	Hlađenje motora (Visko ventilatori, hladnjaci, interkuleri i ekspanzione posude).....	28
1.7	Hlađenje i grejanje kabine (Hladnjaci klime, kompresori klime i izmenjivači toplote).....	30
1.8	Creva vode i interkulera	31
1.9	Filteri	33
1.10	Napajanje gorivom	37
1.11	Davači i senzori	39
1.12	Izduvni sistemi	41

2.0 KVAČILO I TRANSMISIJA

2.1	Setovi kvačila i elementi	46
2.2	Centralni ležajevi kardana	49

3.0 KOČIONA PNEUMATIKA I HIDRAULIKA

3.1	Kompresori i delovi	52
3.2	Isušivači vazduha i filteri	54
3.3	Ventili kočionog sistema	56
3.4	Ventili nivelacije kabine	64
3.5	Cilindri tristop i membranski	65
3.6	Ventili ABS, EBS i ECAS	67
3.7	Senzori	70
3.8	Cilindri kvačila	72
3.9	Pribor kočionog sistema	74
3.10	WABCO i WABCOWÜRTH dijagnostika	83

4.0 KOMPONENTE KOČIONOG SISTEMA

4.1	Disk kočnica	92
4.2	Kočione pločice	95
4.3	Čeljusti kočnica	97
4.4	Glavčine točka, ležajevi i semerinzi	98
4.5	Vijci i navrtke	101

5.0 ELEMENTI OGIBLJENJA I UPRAVLJANJA

5.1	Amortizeri	104
5.2	Vazdušni jastuci	107
5.3	Gibnjevi	110
5.4	Delovi stabilizatora	116
5.5	Delovi rukavca	117
5.6	Spone i delovi spona	118
5.7	Uporne spone	120
5.8	V spone	121

6.0 KABINA I DELOVI KABINE

6.1	Delovi kabine	124
6.2	Ogledala i delovi ogledala	138
6.3	Cilindri i pumpe za dizanje kabine	140
6.4	Elementi za oslanjanje kabine	140
6.5	Uređaji za pranje vetrobranskog stakla	141
6.6	Mehanizam vrata	142
6.7	Prekidači	143

7.0 ELEKTRIČNE INSTALACIJE

7.1	Farovi	146
7.2	Pokazivači pravca	151
7.3	Stop i gabaritna svetla	153
7.4	Rotacione lampe	157
7.5	Sijalice, osigurači i tahograf listići	160
7.6	Kablovi električne instalacije	165
7.7	Kombinovani prekidači pod volanom	168
7.8	Pribori	169
7.9	Anlaseri i alternatori	170

8.0 PRIBORI

8.1	Obeležavajuće table i pribori A.D.R.	174
8.2	Oprema	189
8.3	Pribor za osiguravanje tereta	192
8.4	Lanci za sneg	194
8.5	Vučne kuke	196
8.6	Grejanje kabine	199

9.0 ULJA I MAZIVA

9.1	Ulja i maziva	207
-----	---------------------	-----

1.0 MOTOR



1.0 MOTOR

1.1	Delovi motora	18
1.2	Pumpe vode	22
1.3	Termostati	23
1.4	Španeri motora i prenosni kaiševi	24
1.5	Turbo kompresori	27
1.6	Hlađenje motora (Visko ventilatori, hladnjaci, interkuleri i ekspanzione posude)	28
1.7	Hlađenje i grejanje kabine (Hladnjaci klime, kompresori klime i izmenjivači toplote)	30
1.8	Creva vode i interkulera	31
1.9	Filteri	33
1.10	Napajanje gorivom	37
1.11	Davači i senzori	39
1.12	Izduvni sistemi	41

DELOVI MOTORA

Poz.	Naziv	Federal Mogul broj	Mahle / Miba broj	KS broj	Dimenzije (mm)	Tip motora	OE broj	RAPIDEX broj
1.	Sklop (klip KPL + košuljica)	-	-	-	125	F3AE3681 EU IV/V	500054839	MOTO2549
2.	Klip KPL	87-121900-00	009 68 00	40 339 600	125	F3AE3681 EU II/III	500380393	MOTO2176
3.	Klip KPL		0299 7436		125	F3AE3681 EU IV/V	2996141	MOTO3326
4.	Klip KPL	87-122000-00	009 99 00	40 340 600	135	F3BE0681 EU III	504006111	MOTO2177
5.	Klip KPL	87-428000-00	-	40 340 960	135	F3B3681 EU IV/V	504198895	MOTO2178
6.	Košuljica	15-260040-00	007 WN 74	89 834 110	125	F3AE3681 EU II/III	500338224	MOTO2179





DELOVI MOTORA

Poz.	Naziv	Federal Mogul broj	Mahle / Miba broj	KS broj	Dimenzije (mm)	Tip motora	OE broj	RAPIDEX broj
7.	Košuljica	15-260050-00	007 WN 75	89 831 110	135	F3B3681 EU IV/V	504094025	MOTO2180
8.	Karika	08-121900-00	009 68 N0	800070310	125	F3AE3681 EU II/III	2991781	MOTO2181
9.	Karika	-	-	-	125	F3AE3681 EU IV/V	2996143	MOTO3326
10.	Karika	08-428000-00	-	-	135	F3B3681 EU IV/V	-	MOTO2182
11.	Karika	08-122000-00	009 99 N0	800070410	135	F3BE0681 EU III	2992157	MOTO2183
12.	Ležajevi radilice - leteći	71-4091/6	007 PS 20602	77 888 600	83 x 87 x 40,50	F3AE0681	2991778	MOTO2185
13.	Ležajevi radilice - leteći	71-4095/6	007 PS 20597	77 881 600	90 x 94 x 43,50	F3B3681 EU IV/V, F3BE0681	2992162	MOTO2186
14.	Ležajevi radilice - leteći	H1022/7	007 HS 20600	77 889 600	93 x 99 x 37	F3AE0681	2991780	MOTO2187
15.	Ležajevi radilice - leteći	H1023/7	007 HS 20595	77 882 600	100 x 106,3 x 39	F3B3681 EU IV/V, F3BE0681	2992144	MOTO2188
16.	Čaura klipnjače	55-4094	-	77 890 690	50 x 54 x 48,15	F3AE0681	99468352	MOTO2189
17.	Čaura klipnjače	55-4098	-	77 883 690	54 x 59 x 53,10	F3B3681 EU IV/V, F3BE0681	99460197	MOTO2190

DELOVI MOTORA								
Poz.	Naziv	Federal Mogul broj	Reinz broj	Elring broj	Dimenzije (mm)	Tip motora	OE broj	RAPIDEX broj
18.	Garnitura zaptivača	-	01-34065-01	669.920	125	F2BE0681, F2BE3681	2992259	MOTO2191
19.	Garnitura zaptivača	-	01-34060-01	749.150	125	F3AE0681	500397665	MOTO2192
20.	Garnitura zaptivača	-	01-36535-02	751.590	135	F3BE0681	2992574	MOTO2193
21.	Set zaptivača glave	-	02-34065-01	538.970	125	F2BE0681, F2BE3681	500395171	MOTO2194
22.	Set zaptivača glave	-	02-34060-01	538.960	125	F3AE0681	500397664	MOTO2195
23.	Set zaptivača glave	-	02-36535-02	538.980	135	F3BE0681	2992575	MOTO2196
24.	Zaptivač glave	-	61-34065-00	698.340	125	F2BE0681, F2BE3681	500382172	MOTO2197
25.	Zaptivač glave	-	61-34060-00	381.260	125	F3AE0681	500396535	MOTO1666
26.	Zaptivač glave	-	61-36535-00	457.260	135	F3BE0681	504007514	MOTO1667
27.	Semering radilice	-	81-39939-00	454.050	88 x 123 x 13,65	F2BE0681, F2BE3681	504042684	MOTO2198
28.	Semering radilice	-	81-39941-00	-	112 x 147 x 13,65	F2BE0681, F2BE3681	504042683	MOTO2199
29.	Semering radilice	-	81-40193-00	-	100 x 130 x 14	F3BE0681	40102683	MOTO2200
30.	Semering radilice	-	81-40194-00	-	130 x 160 x 14	F3BE0681	40102693	MOTO2201
31.	Gumica košuljice (crna)	-	-	-	133	F3AE3681 EU IV/V	99456554	MOTO2350
32.	Gumica košuljice (braon)	-	-	-	133	F3AE3681 EU IV/V	99456553	MOTO2349



DELOVI MOTORA						
Poz.	Naziv	Tip motora	OE broj	Dimenzije (mm)	Ugao i kraj stabla	RAPIDEX broj
33.	Ventil usisni	F2BE0681	99456803	40 x 8 x 174	60° I žleb	MOTO2239
34.	Ventil izduvni	F2BE0681	99457210	39 x 8 x 173	45° I žleb	MOTO2240
35.	Ventil usisni	F3AE0681	504042366 500355776	43 x 9 x 202,5	60° I žleb	MOTO2241
36.	Ventil izduvni	F3AE0681	504042367 500355779	42 x 9 x 201,3	45° I žleb	MOTO2242
37.	Ventil usisni	F3BE0681	500355778	47 x 10 x 199,10	60° I žleb	MOTO2243
38.	Ventil izduvni	F3BE0681	500355780	45,9 x 10 x 197,8	45° I žleb	MOTO2244
39.	Vodica usisnog ventila	F2BE0681	500391440	8 x 13,03 x 75,50	-	MOTO2245
40.	Vodica izduvnog ventila	F2BE0681	500391436	8 x 13,03 x 75,50	-	MOTO2246
41.	Vodica usisnog ventila	F3AE0681	500391479	9 x 15,03 x 97	-	MOTO2247
42.	Vodica izduvnog ventila	F3AE0681	500391476	9 x 15,03 x 97	-	MOTO2248
43.	Vodica usisnog ventila	F3BE0681	500390993	10 x 16,04 x 97	-	MOTO2249
44.	Vodica izduvnog ventila	F3BE0681	500390994	10 x 16,04 x 97	-	MOTO2250

1



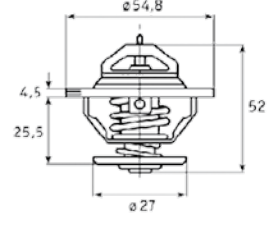
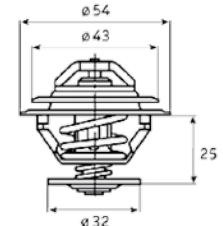
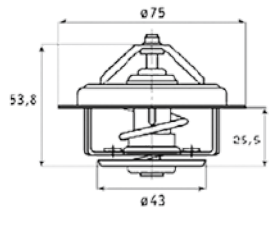
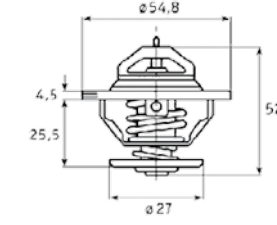
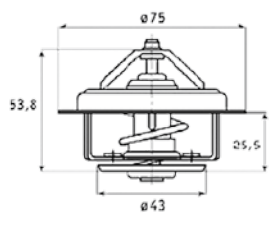

PUMPE VODE						
Slika	Poz.	Model vozila	Tip motora	Frimatec broj	OE broj	RAPIDEX broj
	1.	DAILY III, DAILY IV	F1AE0481B F1AE0481FA	2201143	504033770	MOTO2055
	2.	DAILY IV	F1CE3481LC	2201182	504369725	MOTO2681
	3.	EUROCARGO	F4AE3481B	2201117	504062854	HLAĐ0736
	4.	EUROTRAKKER, TRAKKER, STRALIS	F3BE0681G	2201103	500356553	MOTO2008





1

TERMOSTATI						
Slika	Poz.	Model vozila	T [°C]	KBP	OE broj	RAPIDEX broj
	1.	DAILY, DUCATO	79°C	6.231.79	730361	MOTO0858
	2.	TURBOTECH, EUROTECH	79°C	6.228.79	6131659	MOTO0857
	3.	EUROCARGO	79°C	6.232.79	98432310	MOTO0855
	4.	DAILY, DUCATO	82°C	TH6581.82J	8096735	MOTO1680
	5.	TRAKKER, STRALIS	85°C	204685	99431512	MOTO1168
	6.	STRALIS	84°C	-	5801375230	HLAĐ0563
	7.	STRALIS	79°C	-	504071087	MOTO2337

ŠPANERI

Poz.	Slika	Model vozila	OE broj	KBP	RAPIDEX broj
1.		DAILY II, III	504010846	T43163	MOTO2987
2.		DAILY II, III	504000410	APV1075	MOTO1746
3.		DAILY III	504086948	APV1150	MOTO3057
4.		EUROCARGO	4898548	T38584	MOTO2984

ŠPANERI

Poz.	Slika	Model vozila	OE broj	KBP	RAPIDEX broj
5.		EUROTRAKKER, STRALIS AS/AD	9943631	T38576	MOTO2983
6.		TRAKKER, STRALIS AS/AD	504072744	APV1147	MOTO3056

ROLERI

Poz.	Model vozila	OE broj	KBP	RAPIDEX broj
1.	DAILY II, III	504000412	APV1074	MOTO1745
2.	DAILY II, III	500388688	T42183	MOTO2988
3.	DAILY III, IV	500388688	T42183	MOTO2988
4.	DAILY III, IV	504000410	APV1075	MOTO1746
5.	EUROCARGO	504065878	T36196	MOTO2989
6.	EUROCARGO	4892356	T36516	MOTO2990
7.	EUROSTAR, EUROTRAKKER STRALIS AS/AD	500318393	T36195	MOTO3032

KLINASTI I PK KAIŠEVI

Poz.	Dimenzija (mm)	Model vozila	RAPIDEX broj
1.	13 x 1325	EUROSTAR	REME0220
2.	13 x 1400	EUROTECH, EUROTRAKKER	REME0093
3.	13 x 1425	EUROTECH, EUROTRAKKER	REME0221
4.	13 x 1450	EUROSTAR, CURSOR	MOTO2602
5.	4PK 1041	TRAKKER, STRALIS	REME0344
6.	4PK 1045	STRALIS	REME0389
7.	4PK 1075	CURSOR, STRALIS	REME0071
8.	6PK 1215	DAILY IV, DAILY V	REME0553
9.	7PK 1322	DAILY II, DAILY III	MOTO1748
10.	8PK 1230	EUROCARGO	REME0269
11.	8PK 1688	EUROCARGO	REME0441
12.	10PK 1725	EUROTECH, EUROTRAKKER	REME0230
13.	12PK 1815	STRALIS	REME0285
14.	12PK 1830	TRAKKER, STRALIS	VESA0511

TURBO KOMPRESORI

Poz.	Model vozila	OE broj	RAPIDEX broj
1.	EUROCARGO	504040250	MOTO3030
2.	STRALIS	504269260	MOTO2162

VISKO VENTILATORI

Poz.	Model vozila	Dimenzija (mm)	OE broj	RAPIDEX broj
1.	EUROCARGO	Ø145,5 mm	98468660	MOTO1232
2.	EUROSTARR, EUROTECH, EUROTRAKKER	Ø233 mm	99487209	MOTO0674
3.	EUROSTARR, EUROTECH, EUROTRAKKER, STRALIS	Ø241 mm	41213991	MOTO1608
4.	STRALIS	-	504236556	MOTO2161
5.	EUROCARGO	Ø203 mm	504029738	MOTO2665
6.	STRALIS	-	5801688023	MOTO2685

HLADNJACI

Poz.	Model vozila	Dimenzija (mm)	OE broj	RAPIDEX broj
1.	DAILY II	650 x 440 x 36	504045487	HLAĐ0696
2.	EUROSTAR, EUROTRAKKER, STRALIS	1124 x 748 x 42	41214447	HLAĐ0719
3.	EUROTRAKKER, CURSOR, STRALIS	800 x 748 x 42	41218266	HLAĐ0286
4.	STRALIS	900 x 748 x 42	504011119	HLAĐ0288

INTERKULERI

Poz.	Model vozila	Dimenzija (mm)	OE broj	RAPIDEX broj
1.	EUROCARGO, TECTOR	520 x 432 x 52	500380659	HLAĐ0278
2.	EUROSTAR, CURSOR	900 x 748 x 42	500326345	HLAĐ0279
3.	EUROSTAR, CURSOR, STRALIS	652 x 772 x 52	504015564	HLAĐ0561
4.	STRALIS AS/AD/AT	650 x 870 x 50	41214448	HLAĐ0284

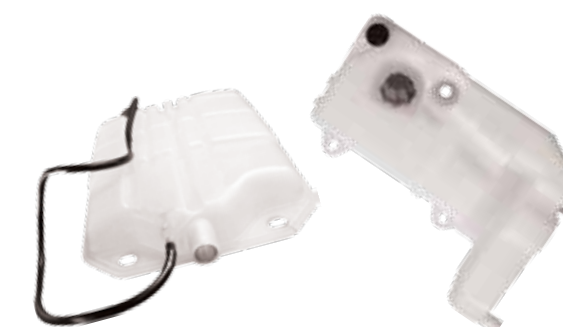
EKSPANZIONE POSUDE

Poz.	Model vozila	Dimenzija (mm)	OE broj	RAPIDEX broj
1.	DAILY	-	504136607	HLAĐ0803
2.	EUROCARGO	-	98426669	HLAĐ0718
3.	EUROCARGO	-	98426670	HLAĐ0675
4.	STARALIS, TRAKKER	589 x 460 x 180	41215631	HLAĐ0680

HLADNJACI KLIME

Poz.	Model vozila	Dimenzija (mm)	OE broj	RAPIDEX broj
1.	TRAKKER, STRALIS	175 x 476 x 75	504011599	HLAĐ0708
2.	STRALIS	439 x 610 x 16	41214450	HLAĐ0793

KOMPRESORI KLIME

Poz.	Model vozila	Opis	OE broj	RAPIDEX broj
1.	EUROSTAR, EUROTRAKKER, STRALIS	-	500341617	HLAĐ0918

IZMENJIVAČI TOPLOTE

Poz.	Model vozila	Dimenzija (mm)	OE broj	RAPIDEX broj
1.	EUROCARGO 1991→	295 x 175 x 42	98418409	HLAĐ0249
2.	STRALIS	400 x 175 x 42	42553964	KABI1718

CREVA VODE					
Slika	Poz.	Model vozila	Dimenzije (mm)	OE broj	RAPIDEX broj
	1.	EUROTECH, EUROTRAKKER	58 x 58 x 475	8164343	HLAĐ0195
	2.	EUROTECH, EUROSTAR	58 x 58 x 830	8161344	HLAĐ0196
	3.	EUROTRAKKER	60 x 60 x 1000	8161345	HLAĐ0197
	4.	STRALIS	55 x 57 x 720	41218703	HLAĐ0105
	5.	STRALIS	55 x 57 x 525	41218702	HLAĐ0106

1

CREVA INTERKULERA					
Slika	Poz.	Model vozila	Dimenzije (mm)	OE broj	RAPIDEX broj
	1.	EUROTRAKKER	90 x 170	42088621	HLAĐ0334
	2.	EUROTRAKKER, EUROTECH	90 x 190	41026109	HLAĐ0335
	3.	EUROTECH	90 x 130 x 130	8134300	HLAĐ0336
	4.	EUROTECH	90 x 140	10900550	HLAĐ0337
	5.	STRALIS	89 x 200	99440309	HLAĐ0694
	6.	STRALIS	89 x 310	41201190	HLAĐ0695

1



FILTERI ULJA									
Poz.	Hengst broj	A (mm)	B (mm)	C (mm)	G (mm)	H (mm)	Model vozila	OE broj	RAPIDEX broj
1.	H210WN	109,00	61,00	70,00	3/4-16UNF	145,50	DAILY I, II, III EUROCARGO I	98472349	FILT0634
2.	H19W12	93,50	62,50	71,50	M22 x 1,5	173,00	DAILY III, IV 1999-	2995561	FILT0633
3.	H17W24	97,00	62,00	72,00	M22 x 1,5	140,00	DAILY III 1999-	8093784	FILT0462
4.	H17W29	95,50	62,00	72,00	M22 x 1,5	144,00	DAILY IV, V 2006-	2995655	FILT0652
5.	H12W08	95,00	62,00	72,00	M22 x 1,5	76,00	DAILY IV, V 2006-	2995811	FILT0433
6.	H19W10	93,50	62,00	70,00	M27 x 2	174,00	EUROCARGO I, II, III 1991-	2992242	FILT0354
7.	H220WN	109,00	92,50	102,0	M30 x 2	212,50	EUROCARGO I, EUROSTAR, EUROTECH, EUROTRAKKER, TURBOSTAR, TURBOTECH	2997305	FILT0769
8.	H230W	108,00	93,00	104,00	M30 x 2	228,50	EUROTECH, EUROTRAKKER, STRALIS	1931099	FILT0250
9.	H311W	136,00	42,00	-	S125 x 4	322,50	TRAKKER, STRALIS 2005-	2996416	FILT0465
10.	-	104,00	52,00	-	-	321,00	TRAKKER, STRALIS	5801592277	FILT1152
11.	E213HD300	-	-	-	-	-	STRALIS EURO 6	5801415504	FILT1577

1

FILTERI GORIVA									
Poz.	Hengst broj	A (mm)	B (mm)	C (mm)	G (mm)	H (mm)	Model vozila	OE broj	RAPIDEX broj
1.	E75KD42	88,00	77,00	84,00		71,50	DAILY I, II 1978-ZETA, TURBO ZETA	9918184	FILT0212
2.	H160WK	87,00	62,50	70,00	M16 x 1,5	186,00	DAILY III 1999-	2992300	FILT0054
3.	E423KPD206	81,00	41,00	14,50		151,00	DAILY IV, V 2006-	504170771	FILT0994
4.	H311WK	100,50				234,50	DAILY IV 2006-	42555920	FILT0081
5.	H18WK05	93,00	62,00	72,00	M20 x 1,5	209,00	EUROCARGO I, II, III 1991-	2992241	FILT0196
6.	H18WDK04	93,00	62,00	71,00	M16 x 1,5	212,00	EUROTECH, EUROTRAKKER, STRALIS	2991585	FILT0258
7.	H60WK01	76,00	62,00	72,00	M16 x 1,5	119,00	EUROTECH 1992-1998	4764693	FILT0054
8.	H152WK	108,00	62,00	71,00	M16 x 1,5	168,00	TRAKKER, STRALIS 2002-	2994048	FILT0262
9.	H201WDK	108,00	62,00	72,00	M16 x 1,5	170,00	TRAKKER, STRALIS 2005-	2995711	FILT0113
10.	E125KPD302	-	-	-	-	-	STRALIS EURO 6	5801516883	FILT1578

PREFILTERI GORIVA									
Poz.	Hengst broj	A (mm)	B (mm)	C (mm)	G (mm)	H (mm)	Model vozila	OE broj	RAPIDEX broj
1.	H70WK09	96,00	62,00	72,00	M14 x 1,5	191,50	EUROCARGO, EUROSTAR, EUROTECH, EUROTRAKKER, TRAKKER, STRALIS	1991061	FILT0307
2.	H215WK	96,00	62,00	72,00	M16 x 1,5	196,50	EUROCARGO, STRALIS	2992662	FILT0251

SEPARATOR GORIVA									
Poz.	Hengst broj	A (mm)	B (mm)	C (mm)	G (mm)	H (mm)	Model vozila	OE broj	RAPIDEX broj
1.	H7091WK10	108,00	94,00	105,00	1-14 UNS	160,00	STRALIS	2997376	FILT0810
2.	H7160WK30	107,50	95,00	104,00	1-14 UNS	219,00	STRALIS EURO 6	5801620130	FILT1580

1

FILTERI VAZDUHA									
Poz.	Hengst broj	A (mm)	B (mm)	C (mm)	G (mm)	H (mm)	Model vozila	OE broj	RAPIDEX broj
1.	E113L	150,00	71,00	9,00	-	336,00	DAILY I 1978-1999	01904581	FILT0767
2.	E434L	163,00	94,00	-	-	353,00	DAILY III, IV 1999-2011	99478393	FILT0082
3.	E219L	243,00	132,00	10,50	-	286,00	EUROCARGO I 1991-2003	1905983	FILT0859
4.	E713L	228,00	150,0	-	-	415,00	EUROCARGO I 1991-2003	2992388	FILT0112
5.	E633L	244,00	150,00	-	-	335,00	EUROCARGO I, II 1991-2008	42553256	FILT0101
6.	E116L	228,00	116,00	-	-	381,00	EUROCARGO I 135E23	1902465	FILT0224
7.	E115L	198,00	103,00	-	-	376,00	EUROCARGO 80E15-135E18	1902077	FILT0075
8.	E214L	243,00	132,00	-	-	376,00	EUROCARGO, SUPERCARGO	1907553	FILT0300
9.	E595L	248,00	150,00	-	-	415,00	EUROCARGO 120-320 TECTOR	42471166	FILT0360
10.	E119L74	327,00	216,00	-	-	618,00	EUROTRAKKER	2991793	FILT0057
11.	E118L	302,00	191,00	-	-	-	TURBOTECH, EUROTECH, EUROTRAKKER, EUROSTAR, STRALIS	1904550	FILT0323
12.	E270L	327,00	216,00	-	-	-	EUROTRAKKER, EUROSTAR, STRALIS	1907695	FILT0297
13.	E681L	313,50	216,50	-	-	-	TRAKKER, STRALIS	2996126	FILT0209
14.	E1150L	-	-	-	-	-	STRALIS EURO 6	5801400571	FILT1579

FILTERI KABINE

Poz.	Hengst broj	A (mm)	B (mm)	C (mm)	G (mm)	H (mm)	Model vozila	OE broj	RAPIDEX broj
1.	E934LI	285,00	161,00	-	-	31,00	DAILY III 1999-	2995965	FILT1031
2.	E2953LI	291,00	191,00	-	-	30,00	DAILY IV, V 2006-	3802821	FILT1030
3.	E1908LI	450,00	200,00	-	-	25,00	TRAKKER, STRALIS	2995694	FILT0049

OSTALI FILTERI

Poz.	Hengst broj	A (mm)	B (mm)	C (mm)	G (mm)	H (mm)	Model vozila	OE broj	RAPIDEX broj
1.	E10H02	58,00	18,50	18,50	-	100,00	SVI MODELI Filter hidraulike volana	1902137	FILT0214
2.	E602L	78,00	63,00	72,50	M16 x 1,5	60,00	TRAKKER, STRALIS	500339085	FILT0312
3.	E39HD120	70,00	34,00	35,00	-	-	Zf menjač	42535049	FILT0697
4.	E101UD178 Ad blue	69,00	25,00	-	-	75,00	EUROCARGO, TRAKKER, STRALIS	42553548	FILT0015
5.	E100UD160 Ad blue	65,50	S15X3	S15X3	-	98,70	EUROCARGO, TRAKKER, STRALIS	4255073	FILT0014
6.	500383040 Uljnih para	262,00	138,00	30,00	-	-	STRALIS	504209107	FILT0783

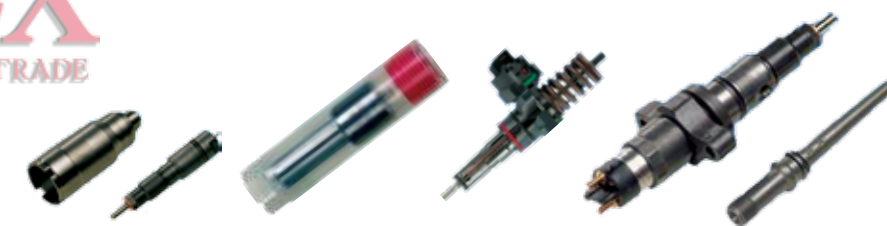
BRIZGALJKE I ULOŠCI BRIZGALJKI

Poz.	Model vozila	Tip motora	KBP	OE broj	RAPIDEX broj
1.	EUROSTAR	8060.25	DLLA136S1000	4800030	NAP.0096
2.	EUROTRAKKER, EUROSTAR, EUROTECH	8210.42	DLLA143S1302	99434328	NAP.0097
3.	TURBOTECH, TURBOSTAR, EUROTRAKKER, EUROSTAR, EUROTECH	8210.42	DLLA145S1169	98413209	NAP.0098
4.	EUROTECH KHD (DEUTZ)	F6L, 8L, 10L, 12L413	DLLA28S656	2145081	NAP.0099
5.	EUROTRAKKER, EUROSTAR, EUROTECH	9460.41CE2, 8460.41L	DSLA134P816	500338048	NAP.0100

REZERVOARI GORIVA

Poz.	Model vozila	Dimenzija (mm)	Zapremina (l)	RAPIDEX broj
1.	EUROTECH	2050 x 680 x 625	800	NAP.0186
2.	EUROSTAR, EUROTECH	1460 x 720 x 720	700	NAP.0034
3.	EUROSTAR, EUROTECH	1960 x 720 x 720	930	NAP.0187

POKLOPCI

Poz.	Naziv	Model vozila	OE broj	RAPIDEX broj
1.	POKLOPAC REZERVOARA Ø80 mm	STRALIS	-	OSTA0086
2.	POKLOPAC REZERVOARA Ø80 mm PLASTIČNI	UNIVERZALNI	-	OSTA0670
3.	POKLOPAC REZERVOARA Ø80 mm METALNI	UNIVERZALNI	-	OPRE0218

PLOVCI

Poz.	Model vozila	OE broj	RAPIDEX broj
1.	EUROSTAR, CURSOR, STRALIS	41042769	NAP.0203
2.	EUROTRAKKER, EUROTRAK CURSOR	41042771	NAP.0204

DELOVI SISTEMA UBRIZGAVANJA

Poz.	Naziv	Model vozila	OE broj	RAPIDEX broj
1.	NOSAC FILTERA GORIVA SA GREJAČEM	STRALIS - CURSOR	42545831	NAP.0366
2.	NOSAC FILTERA GORIVA SA GREJAČEM	EUROCARGO, EUROSTAR, EUROTRAKKER, STRALIS	500316868	NAP.0361

DAVAČI I SENZORI

Slika	Poz.	Model vozila	Tip motora	Dimenzije (mm)	OE broj	RAPIDEX broj
	1.	DAILY	-	-	504025457	ELEK1726
	2.	DAILY	-	-	42535227	NAP.0310
	3.	DAILY II	8140.43	-	500343018	ELEK1727
	4.	DAILY II, DAILY III	F1CE0481 F1CE3481	-	504048261	OSTA2467
	5.	DAILY III, DAILY IV	F1AE0481	-	500371540	ELEK1728
	6.	EUROCARGO	F4AE3481 F4E0681 F4AE3681	-	4890189	ELEK1608

1

DAVAČI I SENZORI						
Slika	Poz.	Model vozila	Tip motora	Dimenzije (mm)	OE broj	RAPIDEX broj
	7.	EUROCARGO	F4AE3481 F4E0681 F4AE3681	-	4890190	ELEK1609
	8.	STRALIS	-	-	500377533	OSTA2043
	9.	TRAKKER, STRALIS	F3BE3681D F3HFE611/410	-	41241706	HLAĐ0765
	10.	EUROCARGO, STRALIS	-	-	5801754015	ELEK2335
	11.	STRALIS	-	-	5801754016	ELEK1935
	12.	STRALIS	-	-	501073323	MOTO1752

1

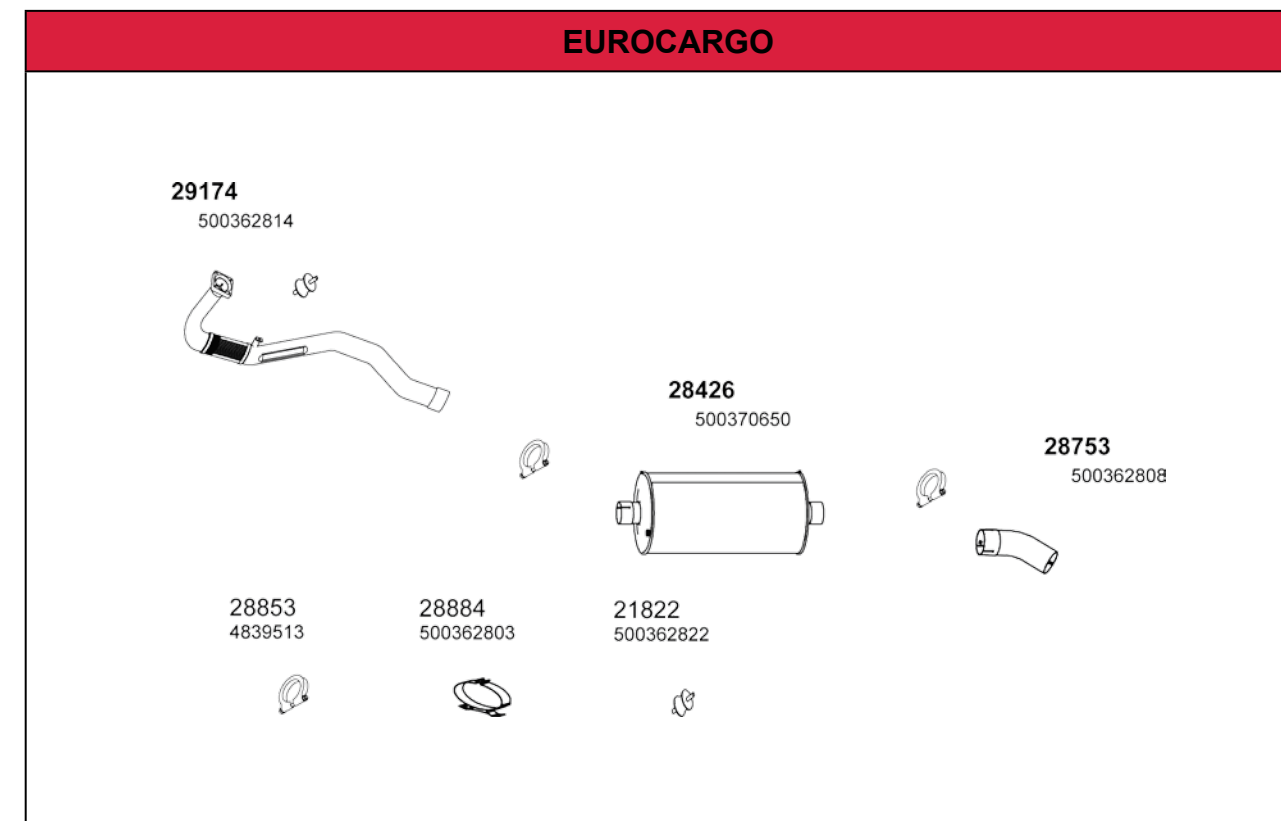

ELEMENTI IZDUVNOG SISTEMA - EURO CARGO				
Poz.	Naziv	Dinex broj	OE broj	RAPIDEX broj
1.	CEV IZDUVNA PREDNJA	29174	500362814	IZDU0219
2.	GUMENI ODBOJNIK	21822	500362822	OSTA2078
3.	NOSAČ LONCA	28884	500362803	IZDU0339
4.	LONAC IZDUVNI	28426	500370650	IZDU0218
5.	ŠELNA AUSPUHA	28853	4839513	OSTA2079
6.	CEV IZDUVNA ZADNJA	28753	500362808	IZDU0308

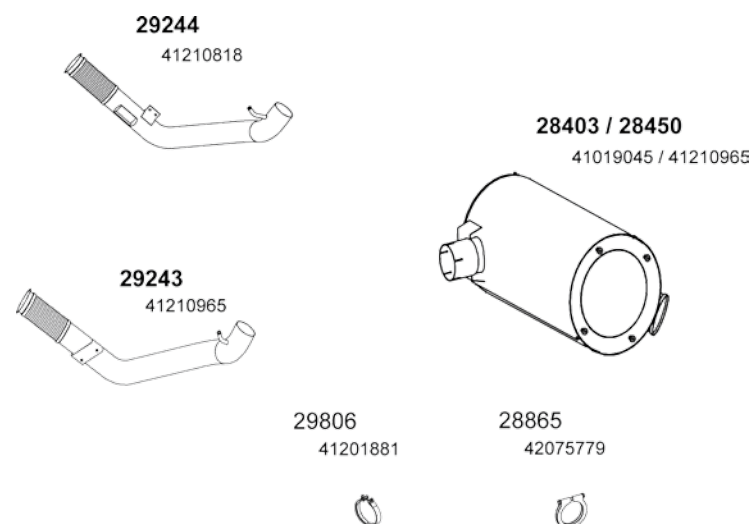
STRALIS E3

ELEMENTI IZDUVNOG SISTEMA - STRALIS E3

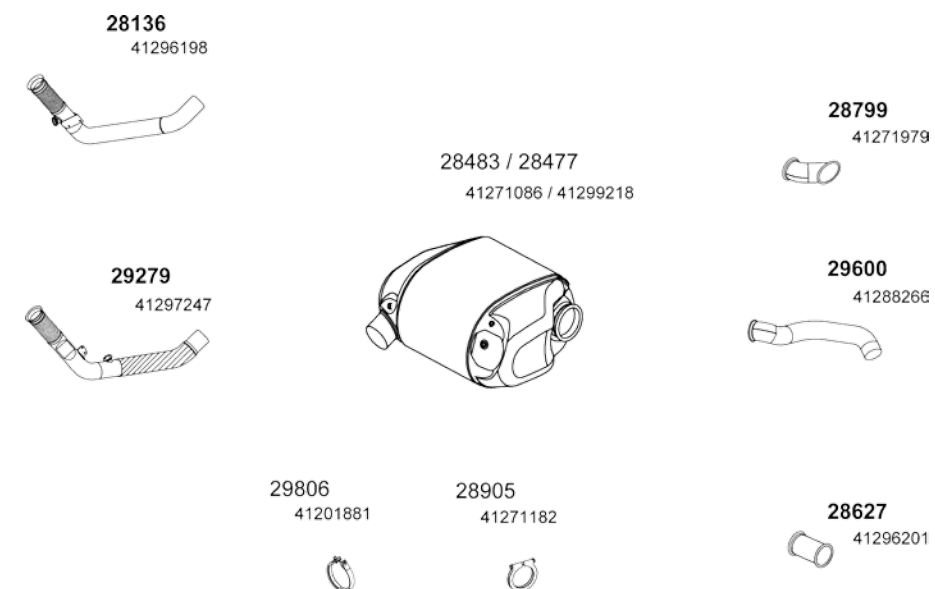
Poz.	Naziv	Dinex broj	OE broj	RAPIDEX broj
1.	LONAC	28403	41019045	IZDU0495
2.	LONAC	28450	41210965	IZDU0496
3.	CEV	29244	41210818	IZDU0432
4.	CEV	29243	41210965	IZDU0497
5.	ŠELNA	29806	41201881	IZDU0493
6.	ŠELNA	28865	42075779	IZDU0389

STRALIS E5

ELEMENTI IZDUVNOG SISTEMA - STRALIS E5

Poz.	Naziv	Dinex broj	OE broj	RAPIDEX broj
1.	LONAC	28483	41271086	IZDU0486
2.	LONAC	28477	41299218	IZDU0487
3.	CEV	28799	41271979	IZDU0488
4.	CEV	29600	41288266	IZDU0489
5.	CEV	28627	41296201	IZDU0490
6.	CEV	28136	41296198	IZDU0491
7.	CEV	29279	41297247	IZDU0492
8.	ŠELNA	29806	41201881	IZDU0493
9.	ŠELNA	28905	41271182	IZDU0494

2.0 KVAČILO I TRANSMISIJA



2.0 KVAČILO I TRANSMISIJA

- 2.1 Setovi kvačila i elementi 46
- 2.2 Centralni ležajevi kardana 49

SETOVI KVAČILA

Poz.	Model vozila	Prečnik	Broj zuba	KBP	OE broj	RAPIDEX broj
1.	DAILY II	Ø265 mm	10	3400 700 447	2994018	KVAC0471
2.	DAILY III, IV	Ø280 mm	10	-	500054749	KVAC0557
3.	DAILY III, IV	Ø280 mm	10	3400 700 483	500055559	KVAC0522
4.	EUROCARGO	Ø330 mm	10	3400 700 431	2996991	MENJ1013
5.	EUROCARGO	Ø350 mm	10	3400 700 430	2996990	MENJ1011
6.	EUROCARGO	Ø362 mm	10	827274	2996528	KVAC0388
7.	EUROCARGO	Ø400 mm	10	827177	504129284	KVAC0489
8.	EUROCARGO	Ø400 mm	10	827262	2996523	MENJ1024
9.	EUROTRAKKER, STRALIS, TRAKKER	Ø400 mm	10	3400 084 031	500392840	KVAC0321

SETOVI KVAČILA

Poz.	Model vozila	Prečnik	Broj zuba	KBP	OE broj	RAPIDEX broj
10.	EUROTECH, EUROTRAKKER, STRALIS, TRAKKER	Ø430 mm	10	3400 117 801	500335105	MENJ0990
11.	STRALIS, TRAKKER	Ø430 mm	10	3400 700 365	504285997	KVAC0320
12.	STRALIS, TRAKKER	Ø430 mm	10	3400 700 368	504148901	MENJ1012
13.	STRALIS, TRAKKER	Ø430 mm	10	3400 700 461	504148906	KVAC0493
14.	STRALIS	Ø430 mm	10	3400 700 462	504148904	KVAC0404

POTISNI LEŽAJEVI

Poz.	Slika	Model vozila	KBP	OE broj	RAPIDEX broj
1.		EUROTECH, EUROTRAKKER, STRALIS, EUROCARGO	3151 000 144	504158912	KVAC0062
2.		STRALIS, TRAKKER	3151 000 493	504385080	KVAC0289



KORPE KVAČILA

Poz.	Model vozila	Prečnik	Tip	KBP	OE broj	RAPIDEX broj
1.	EUROTECH, EUROTRAKKER, TRAKKER	Ø400 mm	MFZ400	3482 078 134	42104648	KVAC0464
2.	STRALIS, TRAKKER	Ø430 mm	MFZ430	3482 000 573	504237890	KVAC0468
3.	EUROTRAKKER, STRALIS, TRAKKER	Ø430 mm	MFZ430	3482 083 032	42102097	KVAC0455



LAMELE KVAČILA

Poz.	Model vozila	Prečnik	Broj zuba	KBP	OE broj	RAPIDEX broj
1.	EUROTECH, EUROTRAKKER	Ø400 mm	10	1878 032 032	500317871	KVAC0467
2.	EUROTRAKKER, STRALIS, TRAKKER	Ø430 mm	10	1878 085 741	504064954	MENJ0240
3.	STRALIS, TRAKKER	Ø430 mm	10	1878 004 133	504225034	KVAC0469

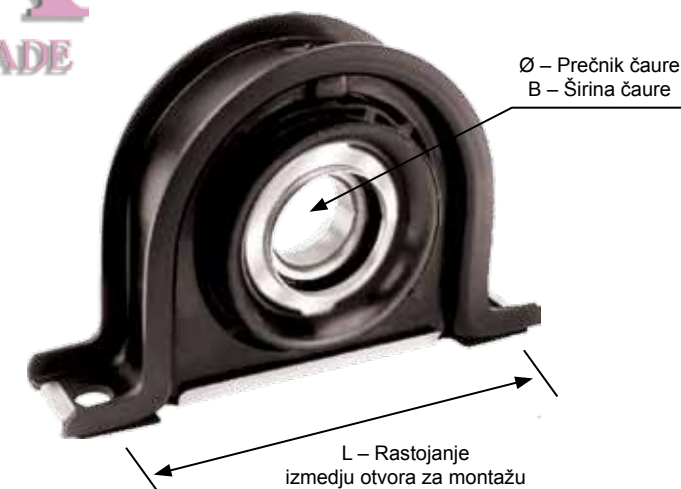

CENTRALNI LEŽAJEVI KARDANA

Poz.	Slika	Model	Ø (mm)	B (mm)	L (mm)	OE broj	RAPIDEX broj
1.		EUROTECH, EUROSTAR, EUROTRAKKER, EUROTECH/ STAR CURSOR, STRALIS	70	17	220	42541437	MENJ0311
2.		EUROTECH, EUROSTAR, EUROTRAKKER, EUROTECH/ STAR CURSOR, STRALIS	75	15	222	93192572	MENJ0312
3.		TURBOTECH, EUROTECH, EUROSTAR, EUROTRAKKER, EUROTRAKKER CURSOR	60	37	220	42536961	MENJ0313 MENJ0867

3.0 KOČIONA PNEUMATIKA I HIDRAULIKA



3.0 KOČIONA PNEUMATIKA I HIDRAULIKA





3.1	Kompresori i delovi	52
3.2	Isušivači vazduha i filteri	54
3.3	Ventili kočionog sistema	56
3.4	Ventili nivelacije kabine	64
3.5	Cilindri tristop i membranski	65
3.6	Ventili ABS, EBS i ECAS	67
3.7	Senzori	70
3.8	Cilindri kvačila	72
3.9	Pribor kočionog sistema	74
3.10	WABCO i WABCOWÜRTH dijagnostika	83



KOMPRESORI					
Poz.	Slika	KBP	Model	OE broj	RAPIDEX broj
1.		411 015 807 0	EUROSTAR	01231528	KOCN0698
2.		911 145 560 0	EUROCARGO	500310905	KOCN1195
3.		LK4936	STRALIS	41211340	KOCN3468

GLAVE KOMPRESORA					
Poz.	Slika	KBP	Model	OE broj	RAPIDEX broj
1.		150760	STRALIS	-	KOCN4208
2.		150720	STRALIS	-	KOCN2963
3.		150860	CARGO	-	MOTO2477

PLOČE KOMPRESORA					
Poz.	Slika	KBP	Model	OE broj	RAPIDEX broj
1.		1500 075 760	STRALIS	-	KOCN4209
2.		1500 085 650	CARGO	-	KOCN2490

ZAPTIVAČI KOMPRESORA					
Poz.	Slika	KBP	Model	OE broj	RAPIDEX broj
1.		1500 075 750	STRALIS	-	KOCN3817
2.		1500 075 100	STRALIS	-	MOTO1995
3.		1500 020 100	STRALIS	-	KOCN3307
4.		1300 035 750	CARGO	-	KOCN3058

ISUŠIVAČI VAZDUHA					
Poz.	Slika	KBP	Model / Opis	OE broj	RAPIDEX broj
1.		432 410 021 0	UNIVERZALNI 9,5 bar	42079486	KOCN1545
2.		432 410 075 0	UNIVERZALNI 11 bar	41031475	KOCN0725
3.		LA8125	EUROTECH, EUROSTAR, STRALIS 12,5 bar	42536872	KOCN1057
4.		ZB4587	STRALIS APU 12,5 bar AE4560+LA8606	41285078	KOCN0494

ISUŠIVAČI VAZDUHA					
Poz.	Slika	KBP	Model / Opis	OE broj	RAPIDEX broj
5.		ZB4593	STRALIS APU 12,5 bar AE4502+LA8125	41211392	KOCN0726
6.		ZB4597	STRALIS APU 12,5 bar AE4527+LA8610	41211397	KOCN2397

FILTERI ISUŠIVAČA VAZDUHA					
Poz.	Slika	KBP	Model / Opis	OE broj	RAPIDEX broj
1.		432 410 222 0	UNIVERZALNI M39 x 1,5 mm	-	KOCN0894
2.		432 901 223 2	UNIVERZALNI NOVI TIP, M39 x 1,5 mm	-	KOCN0923

ČETVOROKRUŽNI / ŠESTOKRUŽNI ZAŠTITNI VENTILI



Poz.	Slika	KBP	Model	Opis	OE broj	RAPIDEX broj
1.		AE4502	EUROTECH, EUROSTAR, STRALIS	ČETVOROKRUŽNI VENTIL ZB4587	42553848	KOCN0945
2.		AE4516	STRALIS	ČETVOROKRUŽNI VENTIL ZB4593	42553849	KOCN0596
3.		AE4608	STRALIS	ČETVOROKRUŽNI VENTIL ZB4601	42536555	KOCN3776
4.		AE4527	STRALIS	ČETVOROKRUŽNI VENTIL ZB4597	42536820	KOCN2467
5.		AE4646	EUROTECH, STRALIS	ČETVOROKRUŽNI VENTIL	99480157	KOCN2300

VENTILI RELEJNI

Poz.	Slika	KBP	Model	OE broj	RAPIDEX broj
1.		973 011 203 0	EUROTECH	41025604	KOCN0870
2.		AC 574 AXY	STRALIS	41031426	KOCN1052
3.		973 001 010 0	INIVERZALNI	-	KOCN1354



VENTILI OGRANIČENJA PRITISKA

Poz.	Slika	KBP	Model	Opis Izlazni / Ulazni pritisak	OE broj	RAPIDEX broj
1.		475 010 015 0	EUROSTAR, EUROCARGO	7,3 - 10 bar	42041172	KOCN1120
2.		475 010 302 0	EUROSTAR	5,5 - 7,5 bar	9926016	KOCN3318
3.		475 015 039 0	EUROCARGO, STRALIS	8,5 - 11 bar	8169587	KOCN0762

VENTILI BRZOG ISPUSTA

Poz.	Slika	KBP	Model	Opis	OE broj	RAPIDEX broj
1.		973 500 000 0	-	M22 x 1,5 mm	-	KOCN1273
2.		973 500 028 0	-	M22 x 1,5 mm 23M16 VOSS	-	KOCN1141
3.		973 500 038 0	-	M 22 x 1,5 mm M16	-	KOCN0501
4.		973 500 042 0	-	M 22 x 1,5 mm VOSS	-	KOCN0702
5.		973 500 051 0	-	INTERGISAN DUPLI	-	KOCN0997

DVOSMERNI VENTILI

Poz.	Slika	KBP	Model	OE broj	RAPIDEX broj
1.		434 202 000 0	UNIVERZALNI	-	KOCN1280
2.		434 208 000 0	UNIVERZALNI	-	KOCN0590
3.		434 208 029 0	UNIVERZALNI	-	KOCN0888



PRELIVNI VENTILI

Poz.	Slika	KBP	Model	OE broj	RAPIDEX broj
1.		434 100 125 0	UNIVERZALNI	2516825	KOCN0766
2.		434 100 130 0	UNIVERZALNI	8169974	KOCN2472
3.		434 100 228 0	UNIVERZALNI	-	KOCN2631

VENTIL RAZVODNIK

Poz.	Slika	KBP	Model	OE broj	RAPIDEX broj
1.		463 036 000 0	UNIVERZALNI	-	KOCN1674
2.		463 036 001 0	UNIVERZALNI	-	KOCN1086

ELEKTROMAGNETNI VENTIL

Poz.	Slika	KBP	Model	OE broj	RAPIDEX broj
1.		472 171 700 0	EUROSTAR	42546462	KOCN0253
2.		472 173 206 0	EUROSTAR	41025617	KOCN3319
3.		472 172 626 0	EUROSTAR, EUROTECH, STRALIS	41026587	KOCN0991



VENTILI RUČNE PARKIRNE KOČNICE

Poz.	Slika	KBP	Model	OE broj	RAPIDEX broj
1.		961 723 003 0	EUROTECH	5000452903	KOCN2186
2.		961 723 208 0	EUROTECH	5010145720	KOCN0359
3.		DPM94AAX	EUROCARGO	98474180	KOCN0495
4.		DPM95AAX	EUROCARGO, STRALIS	500303741	KOCN0522



VENTILI UPRAVLJANJA PRIKOLICE



Poz.	Slika	KBP	Model	OE broj	RAPIDEX broj
1.		973 002 010 0	EUROTECH, EUROSTAR	4760466	KOCN1234
2.		973 002 022 0	EUROCARGO, EUROTECH	4672021	KOCN0739



VENTILI NIVELACIJE KABINE					
Poz.	Slika	KBP	Model	OE broj	RAPIDEX broj
1.		464 007 002 0	EUROTECH, EUROSTAR, STRALIS	-	VESA0049
2.		464 007 003 0	EUROTECH, EUROSTAR, STRALIS	8188642	VESA0047



TRISTOP CILINDRI					
Poz.	SLIKA	KBP	Model / Opis	OE broj	RAPIDEX broj
1.		BT5800	STRALIS 20/27	41285072	KOCN3229
2.		BT5801	STRALIS 20/27	41285073	KOCN3230

CILINDAR RUČNE KOČNICE					
Poz.	SLIKA	KBP	Model	OE broj	RAPIDEX broj
1.		DPA5001	EUROCARGO	504191315	KOCN2967
2.		DPA6101	EUROCARGO	504191316	KOCN3304



MEMBRANE TRISTOP CILINDRA

Poz.	KBP	Tip	Prečnik x Visina	RAPIDEX broj
1.	897 120 495 4	TIP 9	Ø128 x 31 mm	KOCN1555
2.	897 120 505 4	TIP 12 P	Ø139 x 31 mm	KOCN1259
3.	897 120 510 4	TIP 16 P	Ø156 x 35 mm	OSTA3129
4.	897 120 516 4	TIP 16 D	Ø158 x 43 mm	KOCN3541
5.	897 120 520 4	TIP 20 P	Ø128 x 31 mm	KOCN0447
6.	897 120 526 4	TIP 20 D	Ø168 x 38 mm	KOCN1033
7.	897 120 530 4	TIP 24 P	Ø179 x 33 mm	OSTA3130
8.	897 120 535 4	TIP 24 S	Ø179 x 40 mm	KOCN1224
9.	897 120 536 4	TIP 24 D	Ø179 x 45 mm	KOCN3487
10.	897 120 540 4	TIP 30 P	Ø199 x 35 mm	KOCN3684
11.	897 120 546 4	TIP 30 D	Ø200 x 44 mm	KOCN3822
12.	897 121 610 4	TIP 14 P	Ø139 x 28 mm	KOCN4139
13.	897 121 923 4	TIP 12 D	Ø162 x 43 mm	KOCN0926



ABS RELEJNI VENTILI

Poz.	Slika	KBP	Model	OE broj	RAPIDEX broj
1.		472 195 009 0	EUROCARGO, EUROTECH, STRALIS	816 7404	KOCN0820
2.		472 195 016 0	UNIVERZALNI	1934974	KOCN0551
3.		472 195 018 0	UNIVERZALNI	1518589	KOCN1164



ADAPTER KABEL ABS VENTILA

Poz.	Slika	KBP	Model	OE broj	RAPIDEX broj
1.		894 601 132 2	UNIVERZALNI	-	KOCN1154
2.		894 601 133 2	UNIVERZALNI	-	KOCN1156
3.		894 601 134 2	UNIVERZALNI	-	KOCN0251



EBS VENTILI

Poz.	Slika	KBP	Model / Opis	OE broj	RAPIDEX broj
1.		480 202 004 0	EUROTECH, EUROSTAR, STRALIS, Proporcionaln EBS rele ventil	41032230	KOCN1167
2.		480 204 002 0	STRALIS	41032232	KOCN0901

EBS VENTIL - OSOVINSKI MODULATOR

Poz.	Slika	KBP	Model / Opis	OE broj	RAPIDEX broj
1.		480 103 024 0	STRALIS 4x2, 6x2, 6x4	41211004	KOCN0761
2.		480 103 022 0	STRALIS	41032231	KOCN2614

EBS VENTIL - OSOVINSKI MODULATOR

Poz.	Slika	KBP	Model / Opis	OE broj	RAPIDEX broj
3.		480 104 005 0	STRALIS	41211413	KOCN2630
4.		480 104 006 0	STRALIS	41211414	KOCN3261

ECAS ELEKTROMAGNETNI VENTIL

Poz.	Slika	KBP	Model	OE broj	RAPIDEX broj
1.		472 900 065 0	EUROCARGO, STRALIS	41003310	VESA2032

SENZORI ABS

Poz.	KBP	Model	Opis	OE broj	RAPIDEX broj
1.	441 032 921 2	UNIVERZALNI	400 mm, SET, pod uglom	5006041993	KOCN1147
2.	441 032 922 2	UNIVERZALNI	1000 mm, SET, pod uglom	5006041994	KOCN1322
3.	441 032 963 2	UNIVERZALNI	350 mm, SET	-	KOCN0916
4.	441 032 905 0	UNIVERZALNI	350 mm, ravan	-	KOCN1652
5.	441 032 808 0	UNIVERZALNI	400 mm, pod uglom	5801115879	KOCN1216
6.	412 032 858 0	UNIVERZALNI	2050 mm, pod uglom	41200561	KOCN3473
7.	441 032 862 0	UNIVERZALNI	2500 mm, pod uglom	41200584	KOCN3621
8.	441 032 980 0	UNIVERZALNI	2050 mm, ravan	41221280	KOCN3472

PRODUŽNI KABEL SENZORA

Poz.	KBP	Opis	RAPIDEX broj
1.	449 712 008 0	DUŽINA 800 mm	KOCN1655
2.	449 712 018 0	DUŽINA 1800 mm	KOCN0891
3.	449 712 030 0	DUŽINA 3000 mm	KOCN1107
4.	449 712 051 0	DUŽINA 5100 mm	KOCN0719
5.	449 712 060 0	DUŽINA 6000 mm	KOCN0886
6.	449 712 120 0	DUŽINA 12000 mm	KOCN0973

PREKIDAČI PRITISKA

Poz.	Slika	KBP	Opis	OE broj	RAPIDEX broj
1.		441 009 101 0	UNIVERZALNI	-	VESA0642
2.		441 014 006 0	UNIVERZALNI	-	KOCN1658
3.		441 014 010 0	UNIVERZALNI	-	VESA0488
4.		441 014 501 0	UNIVERZALNI	-	KOCN2797
5.		441 014 025 0	UNIVERZALNI	-	VESA0674





SENZOR PRITISKA

Poz.	Slika	KBP	Model / Opis	OE broj	RAPIDEX broj
1.		441 044 107 0	UNIVERZALNI, 10 bar	504255336	KOCN3419

SENZORI ECAS-a

Poz.	Slika	KBP	Model	OE broj	RAPIDEX broj
1.		441 050 120 0	STRALIS	41200708	ELEK0244
2.		441 050 123 0	STRALIS	-	VESA0745



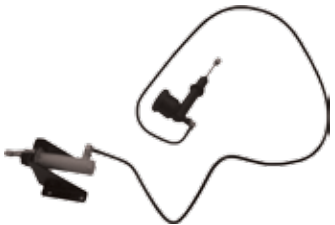

SERVO CILINDRI KVAČILA

Poz.	Slika	KBP	Model	OE broj	RAPIDEX broj
1.		5801317167	EUROCARGO	5801317167	KVAC0483
2.		5801446199	EUROCARGO	5801446199	KVAC0476
3.		41035649	STRALIS	41035649	KOCN3113
4.		0 483 005 005	STRALIS	42536490	MENJ0760

SET CILINDARA KVAČILA

Poz.	Slika	KBP	Model	OE broj	RAPIDEX broj
1.		5801521973	DAILY	5801521973	KVAC0525
2.		504191582	DAILY	504191582	KVAC0541

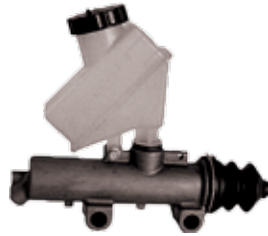
PRIMARNI CILINDRI KVAČILA

Poz.	Slika	KBP	Model	Opis / Odlivak	OE broj	RAPIDEX broj
1.		KG 3107.1.1	EUROSTAR	Ø31,75 mm S 5278	41211006	KVAC0198
2.		KG23017.1.1	EUROSTAR, EUROTECH	S5461	42063311	KVAC0265
3.		KG3107.0.1	EUROSTAR, EUROTECH, STRALIS	Ø31,75 mm S5728	41211005	KVAC0400
4.		KG3107.3.3	TRAKKER, STRALIS	Ø31,75 mm S5728	41211008	KVAC0401

SEKUNDARNI CILINDRI KVAČILA

Poz.	Slika	KBP	Model	Opis / Odlivak	OE broj	RAPIDEX broj
1.		SC2CK	EUROCARGO	-	504033670	KVAC0495



CREVA VAZDUHA

Poz.	KBP	Opis	Dužina	Boja	RAPIDEX broj
1.	40194	SPIRALNO M16 x 1,5 mm	4,5 m	crveno	KOCN4427
2.	40195	SPIRALNO M16 x 1,5 mm	4,5 m	žuto	KOCN4428

SPOJNE GLAVE

Poz.	Slika	KBP	Opis	RAPIDEX broj
1.		452 802 007 0	DUOMATIC - BRZA, M16 x 1,5 mm	KOCN0743
2.		452 802 009 0	DUOMATIC - BRZA sa ABE, M16 x 1,5 mm	KOCN1044

SPOJNE GLAVE

Poz.	Slika	KBP	Opis	RAPIDEX broj
3.		452 803 005 0	DUOMATIC - BRZA, PRIKLJUČAK ABE, M16 x 1,5 mm	KOCN0521
4.		452 804 012 0	DUOMATIC - BRZA, VUČNO VOZILO, M16 x 1,5 mm	KOCN1043
5.		452 805 004 0	DUOMATIC - BRZA, M16 x 1,5 mm	KOCN0520
6.		952 200 021 0	M16 mm, CRVENA, PRIKOLICA	KOCN1345
7.		952 200 022 0	M16 mm, ŽUTA, PRIKOLICA	KOCN1346
8.		952 200 221 0	M16 mm, CRVENA, KAMION	KOCN1347

SPOJNE GLAVE				
Poz.	Slika	KBP	Opis	RAPIDEX broj
9.		952 200 222 0	M16 mm, ŽUTA, KAMION	KOCN1357
10.		952 201 001 0	SA FILTEROM, M16 mm, ŽUTA, max 8,5 bar	KOCN0827
11.		952 201 002 0	SA FILTEROM, M16 mm, CRVENA, max 8,5 bar	KOCN0826
12.		06550	GUMICA SPOJNE GLAVE	KOCN3532



CREVA VAZDUŠNE INSTALACIJE				
Poz.	Opis	Dužina	KBP	RAPIDEX broj
1.	4 x 1,0 mm	25 m	02506	KOCN3581
2.	5 x 1,0 mm	25 m	T 7300.27	KOCN0885
3.	6 x 1,0 mm	25 m	07722	KOCN3631
4.	8 x 1,0 mm	25 m	07723	KOCN3542
5.	9 x 1,5 mm	25 m	02507	OSTA3475
6.	10 x 1,0 mm	25 m	07725	KOCN4093
7.	12 x 1,5 mm	25 m	07726	KOCN3802
8.	15 x 1,5 mm	25 m	07727	KOCN4179
9.	18 x 2,0 mm	25 m	T 7300.20	KOCN1069
10.	NW 11 x 3,5 mm	40 m	01144	KOCN3777
11.	NW 13 x 6,0 mm	40 m	01145	KOCN3740
12.	NW 15 x 5,0 mm	40 m	T 7299.96	KOCN0902



SPOJNICE CREVA			
Poz.	KBP	Opis	RAPIDEX broj
1.	893 129 401 2	CREVO 11 x 3,5 mm, M16 x 1,5 mm	OSTA0257
2.	893 129 402 2	CREVO 11 x 3,5 mm, M22 x 1,5 mm	OSTA0256
3.	893 129 403 2	CREVO 13 x 6 mm, M16 x 1,5 mm	OSTA0255
4.	893 129 404 2	CREVO 13 x 6 mm, M22 x 1,5 mm	OSTA0254
5.	893 226 682 2	UTIČNICA VOSS NG8 WABCO	OPRE0209
6.	893 226 689 2	ADAPTER M16 VOSS SA 232 NA 230	OPRE0021
7.	893 226 690 2	ADAPTER M22 VOSS SA 232 NA 230	OPRE0022
8.	893 800 005 2	CREVO 8 x 1 mm, M22 x 1,5 R mm	OSTA0176
9.	893 800 009 2	CREVO 10 x 1 mm, M16 x 1,5 mm	OSTA2213
10.	893 803 890 0	CREVO10 x 1 mm, M22 x 1,5 mm	OSTA1249
11.	893 800 002 2	CREVO 12 x 1,5 mm, M16 x 1,5 mm	OSTA0476
12.	893 800 008 2	CREVO 12 x 1,5 mm, M22 x 1,5 mm	OSTA0485
13.	893 800 004 2	CREVO 15 x 1,5 mm, M22 x 1,5 mm	OSTA1087
14.	893 800 007 2	CREVO 8 x 1 mm, M12 x 1,5 mm	OSTA0483
15.	893 800 001 2	CREVO 8 x 1 mm, M16 x 1,5 mm	OSTA0482

SPOJNICE CREVA			
Poz.	KBP	Opis	RAPIDEX broj
16.	893 803 022 0	CREVO 6 x 1 mm, M12 x 1,5 mm	OSTA1170
17.	893 800 003 2	CREVO 16 x 2 mm, M22 x 1,5 mm	OSTA0484
18.	893 803 035 0	CREVO 6 x 2 mm, M10 x 1,5 mm	OSTA1171
19.	893 803 780 0	CREVO 15 x 2 mm, M22 x 1,5 mm	OSTA0262
20.	893 831 223 0	CREVO 6 x 1 mm, M12 x 1,5 mm, pod uglom	OSTA0477
21.	893 831 291 0	CREVO 8 x 1 mm, M12 x 1,5 mm, pod uglom	OSTA1570
22.	893 831 293 0	CREVO 8 x 1 mm, M16 x 1,5 mm, pod uglom	OSTA1136
23.	893 831 292 0	CREVO 8 x 1 mm, M22 x 1,5 mm, pod uglom	OSTA0480
24.	893 831 295 0	CREVO 12 x 1,5 mm, M16 x 1,5 mm, pod uglom	OSTA1764
25.	893 831 215 0	CREVO 15 x 1,5 mm, M16 x 1,5 mm, pod uglom	OSTA1901



KUTIJA SA SPOJNICAMA	
KBP	RAPIDEX broj
893 000 200 0	OSTA1115



SPOJNICE CREVA				
Slika	Poz.	Opis	KBP	RAPIDEX broj
	1.	4 mm	T 7820.00	KOCN1102
	2.	5 mm	T 7820.01	KOCN1101
	3.	6 mm	T 7820.02	KOCN1100
	4.	8 mm	T 7820.03	KOCN1099
	5.	10 mm	T 7820.04	KOCN1098
	6.	12 mm	T 7820.05	KOCN1097
	7.	15 mm	T 7820.06	KOCN1096
	8.	22 mm	T 7820.08	KOCN1095
	9.	4 mm	T 7830.00	KOCN1029
	10.	5 mm	T 7830.01	KOCN1710
	11.	6 mm	T 7830.02	KOCN1028
	12.	8 mm	T 7830.03	KOCN1027
	13.	10 mm	T 7830.04	KOCN1026
	14.	12 mm	T 7830.05	KOCN1025
	15.	15 mm	T 7830.06	KOCN1709
	16.	4 mm	T 7840.00	KOCN1022
	17.	5 mm	T 7840.01	KOCN1713
	18.	6 mm	T 7840.02	KOCN1021
	19.	8 mm	T 7840.03	KOCN1020
	20.	10 mm	T 7840.04	KOCN1019
	21.	12 mm	T 7840.05	KOCN1018
	22.	15 mm	T 7840.06	KOCN1714

ALAT ZA BRZE SPOJNICE					
Poz.	Slika	KBP	Opis	OE broj	RAPIDEX broj
1.		899 700 001 4	8 x 1,5 mm	-	OSTA0716
2.		899 700 002 4	12 x 1,5 mm	-	OSTA0717
3.		899 700 003 4	15 x 1,5 / 16 x 2	-	OSTA0718

PRIGUŠIVAČI ZVUKA					
Poz.	Slika	KBP	Opis	OE broj	RAPIDEX broj
1.		432 407 012 0	Ø87 x 62 mm	-	KOCN0746
2.		432 407 060 0	Ø69 x 56,5 mm	-	KOCN0858
3.		432 407 070 0	Ø69 x 53 mm	-	KOCN0859

RAPIDEX

TRADE



3

TEČNOST PROTIV SMRZAVANJA INSTALACIJA

Poz.	KBP	Opis	RAPIDEX broj
1.	830 702 087 4	WABCOTIL 1/1	ULJA0042
2.	830 702 090 4	WABCOTIL 200/1	ULJA0043



DIJAGNOSTIKA
Hardver & Softver

WABCO

Dok je ranijih godina za dijagnostiku svakog sistema na komercijalnim vozilima bio potreban poseban dijagnostički uređaj, danas je dovoljno posedovati JEDAN da bi se uspešno rešavali problemi kako različitih SITEMA tako i različitih proizvođača VOZILA

WABCO u svojoj ponudi raspolaže sa DVA RAZLIČITA dijagnostička sistema:

- WABCO SD sistem - WABCO SISTEMSKA DIJAGNOSTIKA
- WABCO & WÜRTH sistem.

Za svaku od ovih sistema nudimo neophodnu OPREMU, PROGRAME i što je velika retkost OBUKU.



WABCO & WÜRTH - DIJAGNOSTIČKI SISTEM

Ovaj DIJAGNOSTIČKI UREĐAJ predstavlja najsavremeniju UNIVERZALNU DIJAGNOSTIČKU ALATKU na tržištu sa nebrojeno mnogo funkcija i mogućnosti kako za rad, tako i za PERSONALIZACIJU - prema potrebama samog korisnika.

Sam sistem se može dobiti u dve osnovne varijante:

- SA SD WABCO DIJAGNOSTIKOM
- BEZ SD WABCO DIJAGNOSTIKE

Dalje je moguća podela po delokrugu rada na:

- KOMPLETAN PAKET (SISTEMI KAMIONA, PRIKOLICE I BUS-a, LAKI TERETNI PROGRAM)
- KAMIONSKI PAKET
- PRIKOLIČNI PAKET
- BUS PAKET



WABCO & WÜRTH - DIJAGNOSTIČKI SISTEM

Sistemi na vozilima koji se mogu kontrolisati sa ovim uređajima su:

- KOČIONI SISTEM
- MENJAČ
- MOTOR
- ELEKTRIČNE INSTALACIJE
- GREJANJE I HLAĐENJE
- UPRAVLJANJE I VEŠANJE



Zbog stalnog usavršavanja i dopunjavanja teško je definisati krajnje mogućnosti rada ovog uređaja te zbog toga  omogućava proveru mogućnosti uređaja - PREZENTACIJU SVAKOM ZAINTERESOVANOM KLIJENTU kod njega na vozilima koja klijent odabere.

SVI ZAINTERESOVANI MOGU ZAKAZATI BESPLATNU PREZENTACIJU PREKO FIRME „RAPIDEX TRADE“ TE ĆE STRUČNI LJUDI  UBRZO STUPITI U KONTAKT SA ZAINTERESOVANIMA.

Više informacija se može dobiti na: <http://www.wabcowuerth.com>



WABCO **SD - SISTEMSKA DIJAGNOSTIKA**

Za SD dijagnostiku WABCO sistema koristi se sledeća oprema:

- KOFER ZA PROVERU PNEUMATSKE KOČIONE INSTALACIJE
- KOFERI SA DIJAGNOSTIČKOM OPREMOM
- PAKETI DIJAGNOSTIČKIH PROGRAMA

WABCO SD - OPREMA

• **Kofer za dijagnostiku pneumatske kočione instalacije**



W: 435 002 007 0
R: KOCN1763

• **Kofer za dijagnostiku prikoličnih sistema** **W: 446 301 023 0** **R: KOCN0837**

Sadržaj kofera za dijagnostiku sistema na prikolicama i poluprikolicama:

- Diagnostic Interface
- Trailer Standardkabel
- CAN Adapter
- CAN Adapterkabel
- VCS I
- VCS II
- TEBS C / D



• **Kofer za dijagnostiku sistema na kamionima** **W: 446 301 025 0** **R: KOCN1764**

Sadržaj kofera za dijagnostiku sistema na kamionima:

- Adapter 35-pol EPS
- Kabel MB Actros/Citaro
- Kabel EBS Euro Neoplan
- Kabel MAN-TGA
- Kabel EBS IVECO Stralis
- Kabel ABS-D
- Kabel EBS DAF
- Kabel Actros MPII (OBD II)
- Kabel ECAS
- Kabel 15-pol. DAF, Scania, MAN (OBD II)
- Kabel ABS D/E ISO 9141



• **Kofer za dijagnostiku sistema na autobusima** **W: 446 301 026 0** **R: KOCN1765**

Sadržaj kofera za dijagnostiku sistema na autobusima:

- Diagnostic Interface
- Kabel MB Actros/Citaro
- Kabel EBS Euro Neoplan
- Kabel MAN-TGA
- Kabel Setra NF 315 MTS
- Kabel Actros MPII (OBD II)
- Kabel 15-pol. DAF, Scania, MAN (OBD II)



• **Paketi dijagnostičkih programa:**

- PAKET FULL (KAMIONI, AUTOBUSI, PRIKOLICE) **W: 246 301 900 0**
R: OPRE0098
- PAKET PRIKOLICA - POLUPRIKOLICA **W: 246 301 901 0**
R: OPRE0524
- PAKET AUTOBUSI **W: 246 301 902 0**
R: OPRE0525
- PAKET KAMIONI **W: 246 301 904 0**
R: OPRE0526



RAPIDEX TRADE svake godine u saradnji sa WABCO-m organizuje **OBUKU - TRENING** za servisere WABCO sistema.

Obuka se odvija u **EDUKATIVNOM CENTRU** u Novom Sadu, Novosadski put 160.

Do sada je obuku uspešno završilo nekoliko generacija polaznika, koje se uspešno nose sa svakodnevnim problemima kvarova na vozilima širom Srbije i zemalja u okruženju.

Predavač WABCO TRENER gospodin Berislav Babić



Detalji sa obuke u edukativnom centru



- **PROIZVODI i REŠENJA** za komercijalna vozila
- **PRIMENA** za proizvodnju vozila
- **ORIGINALNI KVALITET** za Popravku

4.0 KOMPONENTE KOČIONOG SISTEMA





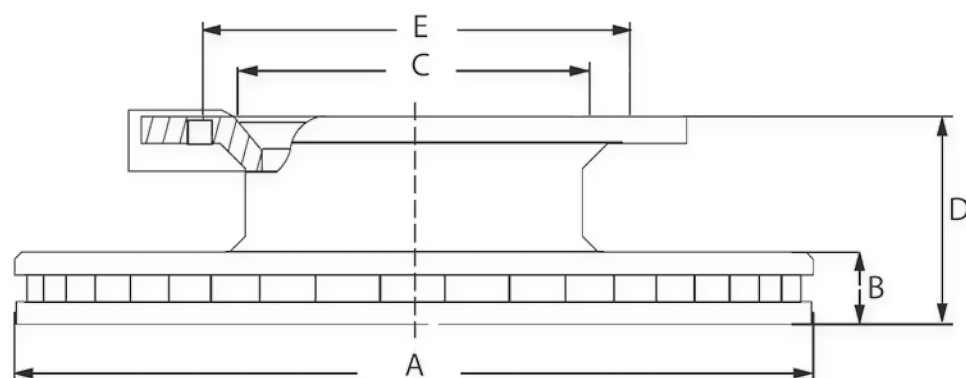

4.0 KOMPONENTE KOČIONOG SISTEMA









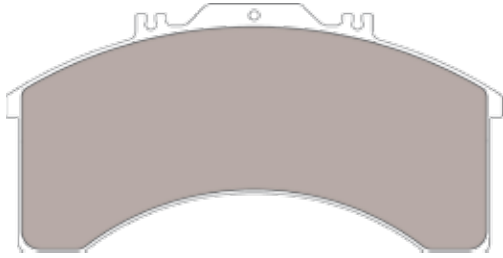

4.1	Disk kočnica	92
4.2	Kočione pločice	95
4.3	Čeljusti kočnica	97
4.4	Glavčine točka, ležajevi i semerinzi	98
4.5	Vijci i navrtke	101

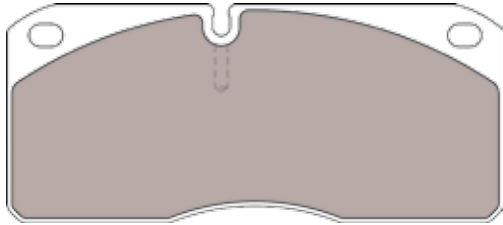



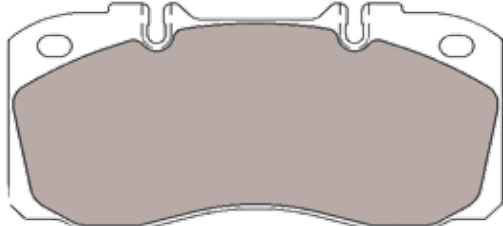

DISK KOČNICA								
	Poz.	Model vozila	OE broj			RAPIDEX broj		
	1.	Daily 35-10K, 35C10, 50C11	1908773			KOCN0850		
A (mm)	Bmin (mm)	Bmax (mm)	C (mm)	D (mm)	E (mm)	Rupe	Pozicija	
289	19	22	84	85	108	8 x Ø10,5 mm	Zd	
	Poz.	Model vozila	OE broj			RAPIDEX broj		
	2.	Daily 3510-3512, 50 C11-15	1908772 42470842			KOCN0851		
A (mm)	Bmin (mm)	Bmax (mm)	C (mm)	D (mm)	E (mm)	Rupe	Pozicija	
290	19	22	170	125	111	6 x M18 x 1,5 mm	Pr	



DISK KOČNICA								
	Poz.	Model vozila	OE broj			RAPIDEX broj		
	3.	Daily 29L10-14, 35S13-17	2996131 504121605			KOCN3169		
A (mm)	Bmin (mm)	Bmax (mm)	C (mm)	D (mm)	E (mm)	Rupe	Pozicija	
300	25	28	78	74,4	125	6 x Ø15,6 mm 1 x Ø8,6 mm	Pr	
	Poz.	Model	OE broj			RAPIDEX broj		
	4.	Daily 60C15, 65C15-18, 70C15	2996122 501121723			KOCN3165		
A (mm)	Bmin (mm)	Bmax (mm)	C (mm)	D (mm)	E (mm)	Rupe	Pozicija	
301	27	30	83	59	111	9 x Ø14,5 mm	Pr	
	Poz.	Model vozila	OE broj			RAPIDEX broj		
	5.	Daily 60C15, 65C15-18, 70C15	2996049			KOCN3168		
A (mm)	Bmin (mm)	Bmax (mm)	C (mm)	D (mm)	E (mm)	Rupe	Pozicija	
306	25	28	178,2	132	215	6 x M16 x 1,25 mm	Zd	
	Poz.	Model vozila	OE broj			RAPIDEX broj		
	6.	Eurocargo 60E10-60E15, 75E12-78E18	1908577 1907528			KOCN3180		
A (mm)	Bmin (mm)	Bmax (mm)	C (mm)	D (mm)	E (mm)	Rupe	Pozicija	
304	27,75	30	165	129	205	6 x M18 x 1,5 mm 2 x M10 x 1,5 mm	Pr	

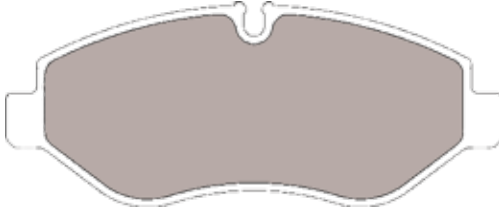

DISK KOČNICA										
	Poz.	Model vozila	OE broj		RAPIDEX broj					
	7.	Eurocargo 100 E15-E21, 80 E15-E22, 90 E17-E21	1907526 1908578 7172018	KOCN2902						
A (mm)	Bmin (mm)	Bmax (mm)	C (mm)	D (mm)	E (mm)	Rupe	Pozicija			
322	27,7	30	215	134	275	8 x Ø20,15 mm 2 x M10 x 1,5 mm	Pr/Zd			
	Poz.	Model vozila	OE broj		RAPIDEX broj					
	8.	Eurostar, Eurotech, Euro cargo	2991979	KOCN0763						
A (mm)	Bmin (mm)	Bmax (mm)	C (mm)	D (mm)	E (mm)	Rupe	Pozicija			
430	46	50	170	102	195	12 x M16 x 1,5 mm	Pr			
	Poz.	Model vozila	OE broj		RAPIDEX broj					
	9.	Stralis, Eurostar, Eurotech, Euro cargo 170-180	2992477 0922.200	KOCN4277						
A (mm)	Bmin (mm)	Bmax (mm)	C (mm)	D (mm)	E (mm)	Rupe	Pozicija			
432	37	48	210	38,5	240	12 x M16 x 2 mm	Pr/Zd			
	Poz.	Model vozila	OE broj		RAPIDEX broj					
	10.	Stralis 06- Euro Cargo 180 06-	2995812	KOCN3599						
A (mm)	Bmin (mm)	Bmax (mm)	C (mm)	D (mm)	E (mm)	Rupe	Pozicija			
432	37	45	210	139	240	12 x M16 x 2 mm	Zd			

KOČIONE PLOČICE						
	WVA broj		Dimenzije (mm)			RAPIDEX broj
		29011	Bendix	240,7	124,8	25
Poz.	Model vozila		OE broj			
1.	EUROCARGO 91- EUROSTAR 93-02, EUROTECH 92-98		2992479			
	WVA broj		Dimenzije (mm)			RAPIDEX broj
	29067	Meritor	175,4	78	22	KOCN1454
Poz.	Model vozila		OE broj			
1.	DAILY, EUROCARGO		1906043			
	WVA broj		Dimenzije (mm)			RAPIDEX broj
	29095	Knorr	210,8	92,5	30	KOCN2485
Poz.	Model vozila		OE broj			
1.	EUROCARGO		2992336			
	WVA broj		Dimenzije (mm)			RAPIDEX broj
	29122	Brembo	174,8	85,3	22	KOCN3195
Poz.	Model vozila		OE broj			
1.	EUROCARGO / IRISBUS		1906419/42555669			
	WVA broj		Dimenzije (mm)			RAPIDEX broj
	29123	Brembo	109,5	63,8	20,3	KOCN1821
Poz.	Model vozila		OE broj			
1.	DAILY II, DAILY III		42561101			

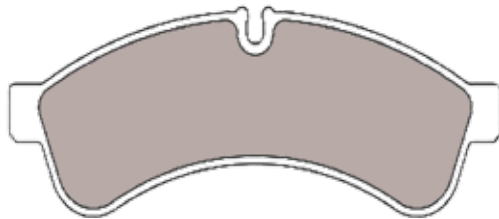
KOČIONE PLOČICE						
	WVA broj		Dimenzije (mm)			RAPIDEX broj
		29202	Knorr	247,3	109,5	30
Poz.	Model vozila		OE broj			
1.	EUROCARGO, EUROTECH, EUROTRAKKER, STRALIS AD/AS		2996428			

	WVA broj		Dimenzije (mm)			RAPIDEX broj
		29229	Brembo	163,3	67,2	21,4
Poz.	Model vozila		OE broj			
1.	DAILY III		42555881			

	WVA broj		Dimenzije (mm)			RAPIDEX broj
		29231	Brembo	184,2	64,8	22,8
Poz.	Model vozila		OE broj			
1.	DAILY, IRISBUS		42555633			

SENZORI ISTROŠENOSTI PLOČICA					
Slika	Poz.	Model vozila	Dimenzije	OE broj	RAPIDEX broj
	1.	EUROCARGO 78E 21, 100E14-21	150 mm	1906462	KOCN3167
	2.	DAILY IV	250 mm	2992394	KOCN3170
	3.	DAILY II	300 mm	1908407	KOCN0839



ČELJUSTI						
Poz.	Model vozila	Tip čeljusti	Proizvođač	KBP	OE broj	RAPIDEX broj
1.	DAILY IV	-	BREMBO	OE	42560072	KOCN3975
2.	DAILY IV	-	BREMBO	OE	42554759	KOCN3512
3.	DAILY IV	-	BREMBO	OE	42554758	KOCN3511
4.	DAILY IV, V	-	BREMBO	OE	42560073	KOCN3974
5.	EUROCARGO	-	BREMBO	OE	42534118	KOCN2399
6.	EUROCARGO	-	BREMBO	OE	42534117	KOCN2398
7.	STRALIS	22,5	KNORR	OE	41285186	KOCN3302
8.	STRALIS	22,5	KNORR	OE	41285185	KOCN3303
9.	STRALIS	22,5	KNORR	SN7042/K013161	41211269	KOCN1391
10.	STRALIS	22,5	KNORR	SN7042/K01360	41211270	KOCN1392



GLAVČINE TOČKA

Poz.	Model vozila	OE broj	RAPIDEX broj
1.	STRALIS	7183908	OSOV1115



LEŽAJEVI

Poz.	Model vozila	Dimenzije (mm)			KBP	OE broj	RAPIDEX broj
1.	DAILY	62	25	18,25	30305	93806250	OSOV0421
2.	EUROCARGO 120E18 00-	130	78	90	805092C	7182915	OSOV0892
3.	EUROCARGO 135, EUROTRACKER	160	105	35	32021X VKHB2160	8190538	OSOV0789
4.	EUROSTAR, EUROTECH	180	100	49	32220A	1905351	OSOV0217
5.	EURO CARGO, EUROTECH, TRACKER, STRALIS 03-	160	90	126	VKBA5397	1905487	OSOV0149
6.	STRALIS 03-	37	120	70	SET1208	1905273	OSOV0977



SEMERINZI

Poz.	Model vozila	Dimenzije (mm)			OE broj	RAPIDEX broj
1.	EUROCARGO	114	153	13	99457401	OSOV0445
2.	EUROCARGO	100	130	14	40100113	OSOV0746
3.	EUROTRACKER, EUROTECH, EUROSTAR	140	165	13	98467213	OSOV0444
4.	EUROCARGO, STRALIS, TRACKER	95	130	16	40102143	OSOV0757
5.	EUROTECH, EUROTRACKER	179	200	15,7	40102941	OSOV0447
6.	EUROTECH, TRACKER	180	200	12	40100443	OSOV0308

VIJCI I NAVRTKE

Poz.	Model vozila	Naziv	Dimenzije (mm)			Navoj	OE broj	RAPIDEX broj
1.	STRALIS	VIJAK	84	73	42	M22 x 1,5	42127262	OSOV1350
		NAVRTKA	-	-	-	M22 x 1,5	41036367	OSOV1183

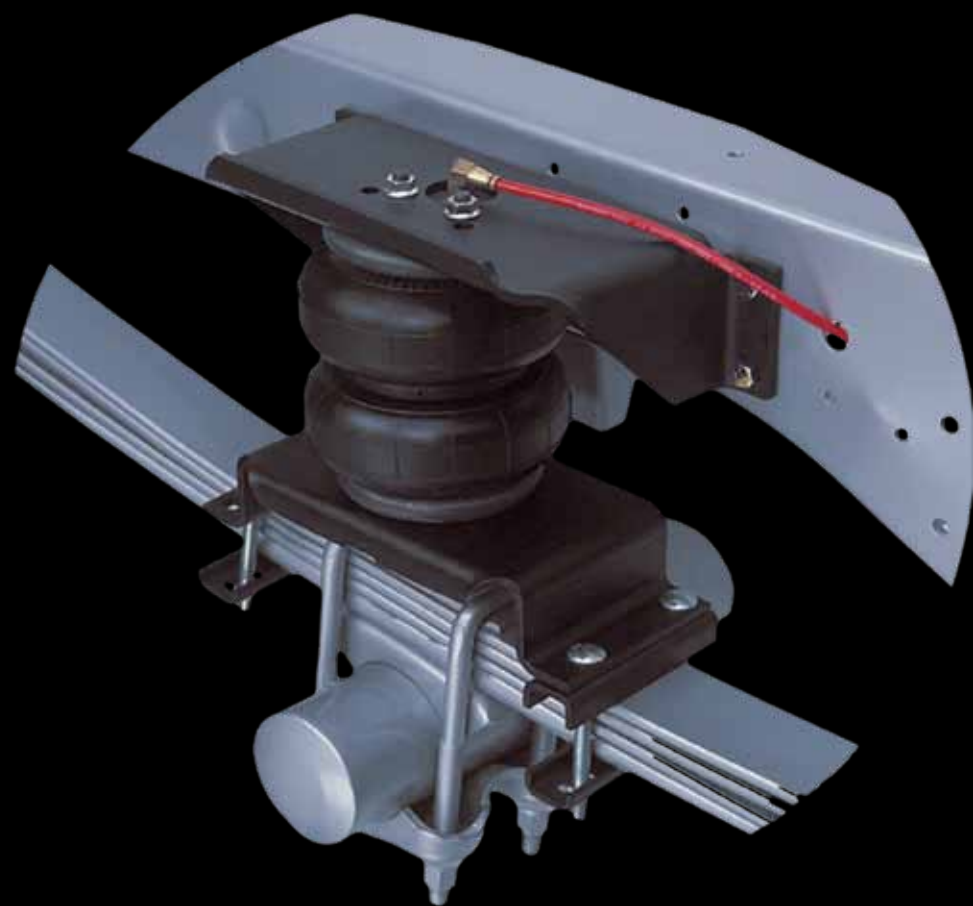
5.0 ELEMENTI OGIBLJENJA I UPRAVLJANJA



5.0 ELEMENTI OGIBLJENJA I UPRAVLJANJA

5.1	Amortizeri	104
5.2	Vazdušni jastuci	107
5.3	Gibnjevi	110
5.4	Delovi stabilizatora	116
5.5	Delovi rukavca	117
5.6	Spone i delovi spona	118
5.7	Uporne spone	120
5.8	V spone	121

AMORTIZERI - TIPOVI VEZA

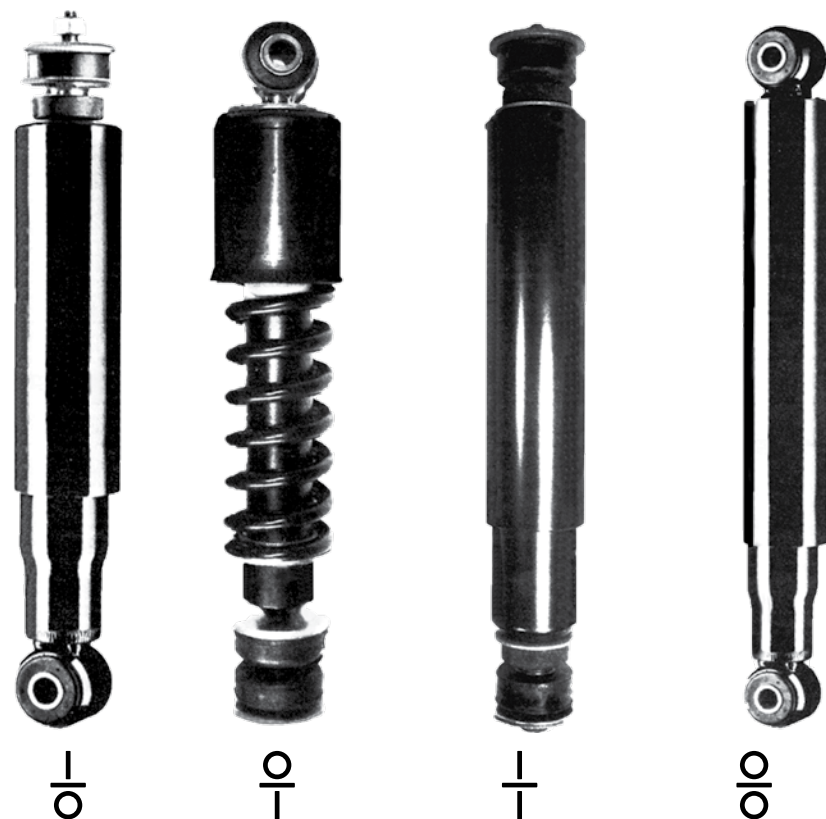

LEGENDA:

SIMBOL	ZNAČENJE	SIMBOL	ZNAČENJE
	VEZA OKO - OKO		AMORTIZER PREDNJE OSOVINE
	VEZA OKO - VIJAK		AMORTIZER ZADNJE OSOVINE
	VEZA VIJAK - OKO		PREDNJA I ZADNJA OSOVINA
	VEZA VIJAK - VIJAK		AMORTIZER KABINE - PREDNJI
	VEZA OKO - VILJUŠKA		AMORTIZER KABINE - ZADNJI
	AMORTIZER VOLANA		AMORTIZER KABINE



AMORTIZERI

Poz.	Model vozila	Osovina	Tip veze	OE broj	Sachs broj	RAPIDEX broj
1.	DAILY III, IV			5801345772	312 700	AMOR0535
2.	DAILY III			5801345776	131 909	VESA2161
3.	DAILY III			5801345771	312 375	AMOR0561
4.	DAILY I, II, III, IV			5801345775	312 378	AMOR0570
5.	EUROCARGO 60E, 65E, 75E, 80E, 100E			98411159	112 498	AMOR0290
6.	EUROCARGO 80E, 100E			98411160	112 554	AMOR0291
7.	EUROSTAR 190E, 240E, 260E, 440E, EUROSTAR CURSOR 260E, EUROTECH MP, STRALIS			41214818	131 621	AMOR0007
8.	EUROSTAR, CURSOR, EUROTECH, EUROTRAKKER, STRALIS			41214700	131 377	AMOR0014
9.	STRALIS AS440S35, AS440S48			41225418	310 049	AMOR0008
10.	EUROSTAR, CURSOR, EUROTECH, EUROTRAKKER, STRALIS			41272149	313 001	AMOR0441
11.	EUROSTAR, CURSOR, EUROTECH, EUROTRAKKER, STRALIS			41006921	125 939	AMOR0540



AMORTIZERI - KABINE

Poz.	Model vozila	Mesto ugradnje	Tip veze	Monroe broj	OE broj	RAPIDEX broj
1.	EUROTECH, EUROSTAR, EUROTRAKKER			CB0073	500348789	AMOR0133
2.	EUROTECH, EUROSTAR, EUROTRAKKER			CB0077	41015530	AMOR0136
3.	STRALIS 02/02→			CB0137	500357351	AMOR0178 AMOR0467
4.	STRALIS 02/02→			CB0136	500357352	AMOR0196
5.	STRALIS 02/02→			-	504080540	AMOR0506
6.	TRAKKER, STRALIS			CB0149	504060233	AMOR0564
7.	EUROCARGO			CB0072	504051670	AMOR0655
8.	EUROTECH			CB0179	41015530	AMOR0760
9.	EUROCARGO			CB0138	98408733	AMOR0605



884N				
	Broj proizvođača dela	OE broj	Primena / Opis	RAPIDEX broj
	Contitech 884N	8188539	-	VESA1618
	Fabio 34884			

944N				
	Broj proizvođača dela	OE broj	Primena / Opis	RAPIDEX broj
	Contitech 944N	4722525	STRALIS	VESA1758
	Fabio 34944			

1SC250-19				
	Broj proizvođača dela	OE broj	Primena / Opis	RAPIDEX broj
	Gomma 1SC250-19	41006926	STRALIS	VESA1974
	Fabio 344250			

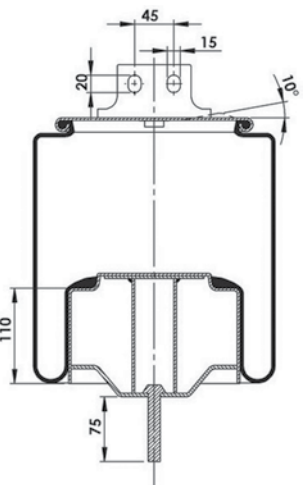
3427023-C				
	Broj proizvođača dela	OE broj	Primena / Opis	RAPIDEX broj
	Fabio 3427023-C	41270462	STRALIS PREDNJI LEVI	VESA2635

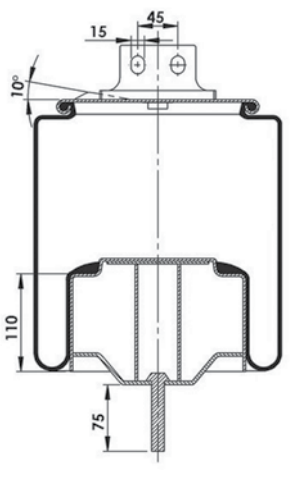
3427023-1C				
	Broj proizvođača dela	OE broj	Primena / Opis	RAPIDEX broj
	Fabio 3427023-1C	41270463	STRALIS PREDNJI DESNI	VESA2636

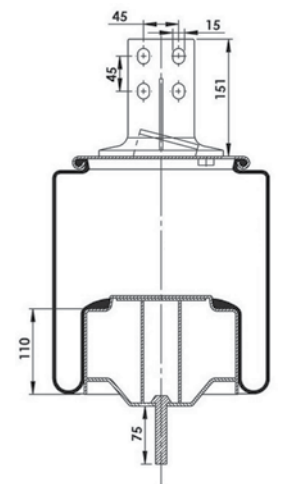
3427023-2C				
	Broj proizvođača dela	OE broj	Primena / Opis	RAPIDEX broj
	Fabio 3427023-2C	41270465	STRALIS ZADNJI LEVI	VESA2637

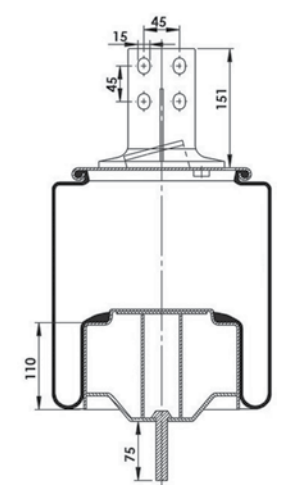
3427023-3C				
	Broj proizvođača dela	OE broj	Primena / Opis	RAPIDEX broj
	Fabio 3427023-3C	41270466	STRALIS ZADNJI DESNI	VESA2638



EUROCARGO, TECTOR (prednja osovina)

Poz.	Model vozila	Opterećenje (t)	Širina (mm)	Broj listova x debljina lista (mm)	Dužina Lx/Ly (mm)	OE broj	RAPIDEX broj
1.	Eurocargo 75E14, E18 100E17, E18, E22 75E15 Tector restyling	2,0	70	1 x 29	857/857	504010274	VESA1651
2.	Eurocargo 130E18, 150E15-27, Tector 130E18-24, 150E18-28	-	80	8 x 13	879/879	98447663	VESA0310

STRALIS (prednja osovina)

Poz.	Model vozila	Opterećenje (t)	Širina (mm)	Broj listova x debljina lista (mm)	Dužina Lx/Ly (mm)	OE broj	RAPIDEX broj
3.	Stralis 260S31, S36 Stralis 440S40, S43, S48, S54	7,5	90	1 x 40	950/945	41226736	VESA1165

EUROCARGO, TECTOR (zadnja osovina)

Poz.	Model vozila	Opterećenje (t)	Širina (mm)	Broj listova x debljina lista (mm)	Dužina Lx/Ly (mm)	OE broj	RAPIDEX broj
4.	Eurocargo 170E17, E18, E23, E27	-	80	3 x 24 1 x 38	840/840	98404951	VESA1202
5.	Eurocargo 75E12-15, Tector 75E13-18	-	70	2 x 16 1 x 40 1 x 27	835/835	99445125	VESA0311
6.	Eurocargo 65E12H, 75E13-18, Tector 75E13-18	-	70	4 x 12 3 x 22	835/835	99445128	VESA0312

EUROTRAKKER (prednja osovina)

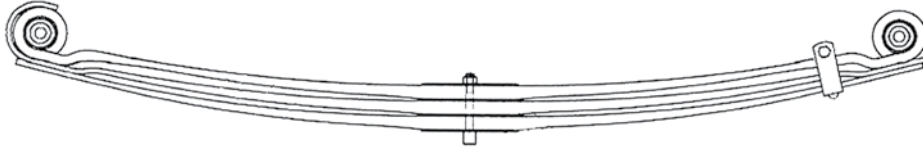
Poz.	Model vozila	Opterećenje (t)	Širina (mm)	Broj listova x debljina lista (mm)	Dužina Lx/Ly (mm)	OE broj	RAPIDEX broj
7.	Eurotrakker 340E34-37, 410E42	-	90	3 x 25	760/760	8161631	VESA0313
							

EUROTRAKKER, EUROTRAKKER CURSOR (zadnja osovina)

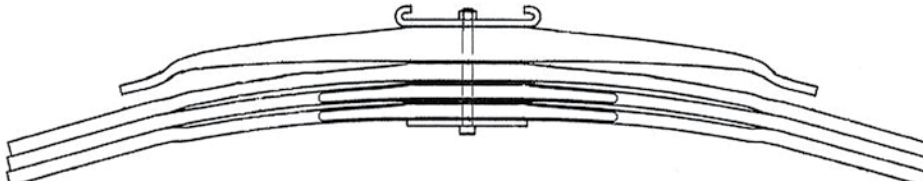
Poz.	Model vozila	Opterećenje (t)	Širina (mm)	Broj listova x debljina lista (mm)	Dužina Lx/Ly (mm)	OE broj	RAPIDEX broj
8.	Eurotrakker, Eurotrakker Cursor	13,0	100	3 x 26 1 x 53 1 x 10	730/730	42126135	VESA0314
							

EUROTRAKKER, EUROTRAKKER CURSOR (zadnja osovina)

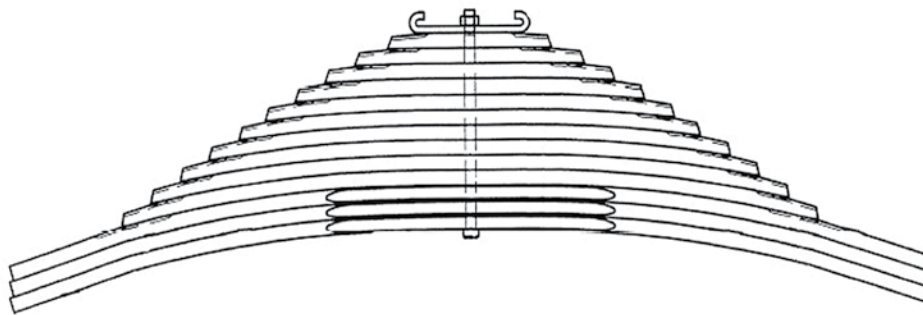
Poz.	Model vozila	Opterećenje (t)	Širina (mm)	Broj listova x debljina lista (mm)	Dužina Lx/Ly (mm)	OE broj	RAPIDEX broj
9.	Eurotrakker, Eurotrakker Cursor	16,0	100	13 x 22 1 x 10	730/730	42121640	VESA0315
							

EUROTECH CURSOR, EUROSTAR CURSOR, STRALIS (prednja osovina)

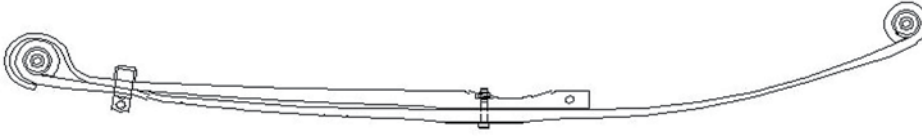
Poz.	Model vozila	Opterećenje (t)	Širina (mm)	Broj listova x debljina lista (mm)	Dužina Lx/Ly (mm)	OE broj	RAPIDEX broj
10.	190E31-43, 260E31-39, 440E35-39, Stralis 190S27-50, 260S27-50	-	90	1 x 25 1 x 40	950/931	500355490	VESA0316
							

EUROTECH, EUROTECH CURSOR, STRALIS (prednja osovina)

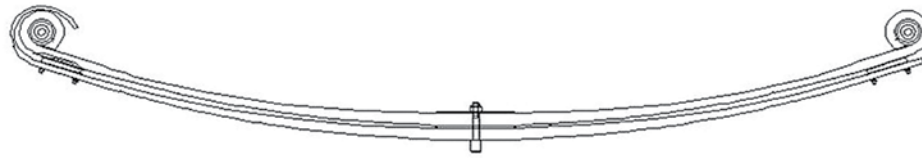
Poz.	Model vozila	Opterećenje (t)	Širina (mm)	Broj listova x debljina lista (mm)	Dužina Lx/Ly (mm)	OE broj	RAPIDEX broj
11.	190E24-43, 240E38, 260E24-43, 440E31-43, 190S27-50, 260S27-43, 440S43-56	7,5	90	2 x 29	950/945	41213060	VESA0317
							

EUROTRAKKER CURSOR, EUROTECH 2, STRALIS (prednja osovina)

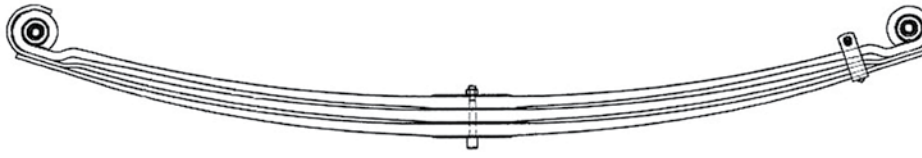
Poz.	Model vozila	Opterećenje (t)	Širina (mm)	Broj listova x debljina lista (mm)	Dužina Lx/Ly (mm)	OE broj	RAPIDEX broj
12.	180E24-27, 190E24-44, 260E30-44, 330E34-37, 380E31-47, 400E31-44, 440E37-44, 260S48-54, 440S40-54	8,0	90	1 x 25 2 x 26	950/950	8161628	VESA0318
							

EUROTRAKKER CURSOR (zadnja osovina)

Poz.	Model vozila	Opterećenje (t)	Širina (mm)	Broj listova x debljina lista (mm)	Dužina Lx/Ly (mm)	OE broj	RAPIDEX broj
13.	330E35-36, MP330E34H-37H MP720E37HT-42HT	10,5	100	3 x 26 1 x 43 1 x 10	730/730	42126923	VESA0319

ČAURE

Slika	Poz.	Model vozila	Dimenzije d x D x h (mm)	SE-M broj	OE broj	RAPIDEX broj
	1.	Eurocargo 65E12H, 75E13-18, Tector 75E13-18	16 x 45,5 x 40	9260	98482540	VESA1023
	2.	Eurotrakker 340E34-37, 410E42, Stralis 190E24-43, 240E38, 260E24-43, 440E31-43, Stralis 190S27-50, 260S27-43, 440S43-56	20,3 x 62 x 97	8190	8160686	VESA1024
	3.	Daily I, II, III, IV, V	33 x 65 / 75 x 34	12999	500350342	VESA2105

ČAURE

Slika	Poz.	Model vozila	Dimenzije d x D x h (mm)	SE-M broj	OE broj	RAPIDEX broj
	4	Daily I, II, III, IV, V	38 x 65 x 34	13000	500350343	VESA2106
	5.	Daily III	28 x 50 / 65 x 25	11663	504039506	VESA2083
	6.	Daily III	16 x 55 x 26	13026	500339201	VESA2283
	7.	Daily III	28 x 50 / 65 x 25	13025	504039506 S	KABI1816

DELOVI STABILIZATORA							
Slika	Pozicija	Model vozila	Mesto ugradnje	Dimenzije d x D x h (mm)	SE-M broj	OE broj	RAPIDEX broj
	1.	EUROSTAR, EUROTECH, STRALIS	PO/ ZO	29 x 62 x 50	9631	8162306	VESA1573
	2.	EUROCARGO, EUROSTAR, EUROTECH, STRALIS	ZO	34 x 46 x 65	9632	41015581	VESA1590
	3.	EUROSTAR, EUROTECH, STRALIS	ZO	56 x 94 x 70 x 80	9612	2521481	VESA0816

DELOVI RUKAVACA				
Slika	Poz.	Model vozila	OE broj	RAPIDEX broj
	1.	EUROCARGO	190 4697	OSOV1045
	2.	EUROTECH, EUROCARGO, EUROSTAR, STRALIS	190 4698	OSOV0862

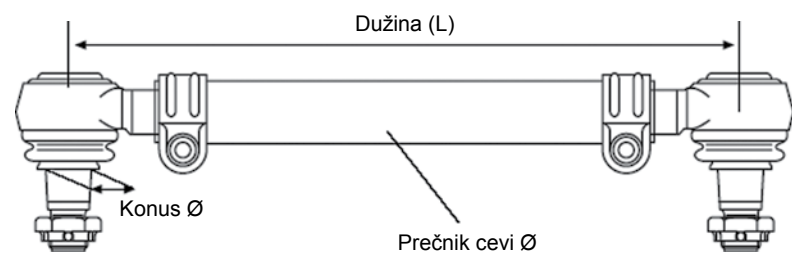

SPONE				
Poz.	Model vozila	Opis	OE broj	RAPIDEX broj
1.	EUROCARGO	Dužina: 897 (mm) Ø Cevi: 42 (mm) Ø Konusa: 26 (mm)	04854874	VESA1981
2.	EUROCARGO	Dužina: 822 (mm) Ø Cevi: 40 (mm) Ø Konusa: 26 (mm)	98402544 98467459	VESA2006
3.	EUROSTAR, EUROTECH, EUROTRAKKER, STRALIS	Dužina: 953 (mm) Ø Cevi: 52 (mm) Ø Konusa: 30 (mm)	08132397 41005463	VESA2007
4.	EUROCARGO	Dužina: 1490 (mm) Ø Cevi: 38 (mm) Ø Konusa: 26 (mm)	98402553 500307556	VESA2849
5.	EUROSTAR, EUROTECH, EUROTRAKKER, STRALIS	Dužina: 1631 (mm) Ø Cevi: 48 (mm) Ø Konusa: 30 (mm)	41005451 8163773	VESA0866

SPONE				
Poz.	Model vozila	Opis	OE broj	RAPIDEX broj
6.	EUROSTAR, EUROTECH, STRALIS	Dužina: 1631(mm) Ø Cevi: 48 (mm) Ø Konusa: 30 (mm)	41036943	VESA1446

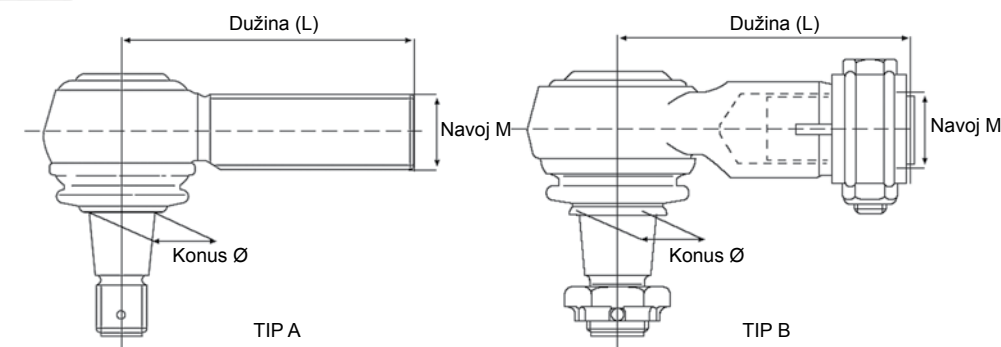

DELOVI SPONA							
Poz.	Model vozila	Dužina L (mm)	Konus Ø (mm)	Navoj M (mm)	Tip A/B	OE broj	RAPIDEX broj
1.	TRAKKER, STRALIS	55	-	M12 x 1.75 ∪	B	8198187	VESA2887
2.	TRAKKER, STRALIS	55	-	M12 x 1.75 ∪	B	8198188	VESA2886
3.	TRAKKER, STRALIS	85	12	M14 x 1.5 ∪	A	86027074	VESA2907
4.	EUROCARGO	115	26	M30 x 1.5 ∪	A	42493782	VESA2885
5.	EUROCARGO	115	26	M30 x 1.5 ∪	A	42493781	VESA2884
6.	TRAKKER, STRALIS	120	30	M30 x 1.5 ∪	A	4802444	VESA2023
7.	TRAKKER, STRALIS	120	30	M30 x 1.5 ∪	A	4802443	VESA2022

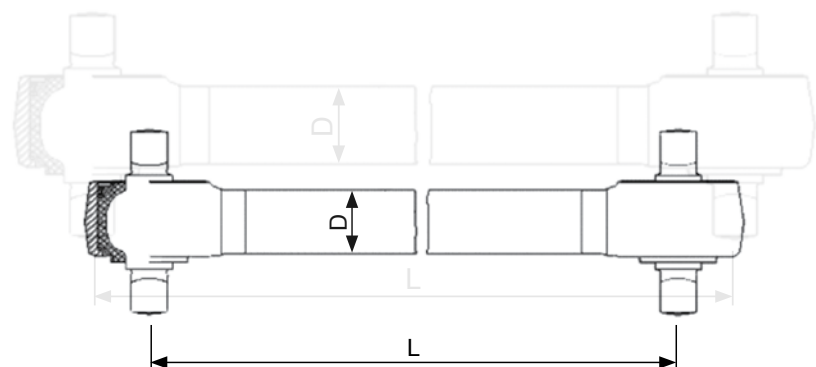
UPORNE SPONE

Poz.	Model vozila	L (mm)	D (mm)	Reparatur set	Lemförder broj	OE broj	RAPIDEX broj
1.	EUROCARGO, TRAKKER, STRALIS	594	46	9319 2361	11732 02	41009661	VESA2051
2.	EUROCARGO 260-320E 01/92→, EUROSTAR LD 260-440E 01/93-02/02, EUROTECH MP 240-440E 01/92→, EUROTRAKKER MP 260-440E 01/93-11/04	610	50	93192618	19991 01	42041107	VESA0994

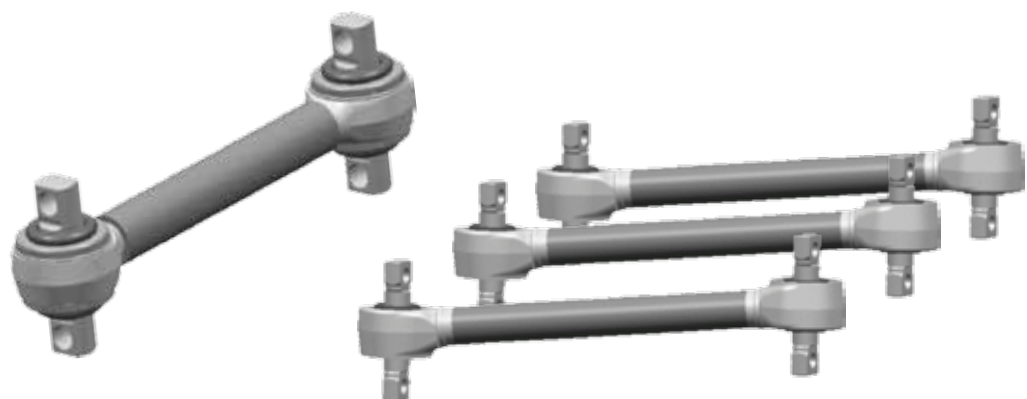
V SPONE

Poz.	Model vozila	L (mm)	D (mm)	Reparatur set	Lemförder broj	OE broj	RAPIDEX broj
1.	EUROSTAR LD, EUROTECH MP, EUROTECH MT, EUROTRAKKER MP, STRALIS AS260S40-54, STRALIS AS440S40-54	665	46	93161958 (1x) 93161960 (2x)	11715 01	41042050	VESA2055

6.0 KABINA I DELOVI KABINE



6.0 KABINA I DELOVI KABINE

6.1	Delovi kabine	124
6.2	Ogledala i delovi ogledala	138
6.3	Cilindri i pumpe za dizanje kabine	140
6.4	Elementi za oslanjanje kabine	140
6.5	Uređaji za pranje vetrobranskog stakla	141
6.6	Mehanizam vrata	142
6.7	Prekidači	143



KARO0671
504045194



KARO0672
504045193



KARO0673
504044980



KARO0674
504044981



KARO0946
41213696



KARO0675
504003993



KARO0676
504003992



KARO0677
41213750



KARO0011
504036807



KARO0010
500398112

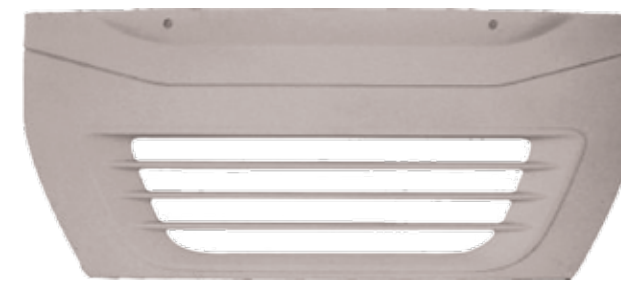

KARO0012
504036808



KARO0013
500364901



RASV0336
504238093



RASV0334
504238117



KARO0014
504065985



KARO0017
504065982



KARO0016
504074676



KARO0015
504065984





KARO0678
504022497



KARO0679
504022498



KARO0680
504022500



KARO0681
504022499



KARO0018
500375473



KARO0019
500375472



KARO0020
500375431



KARO1422
504001361

KARO1421
504001345

KARO0021
500375430

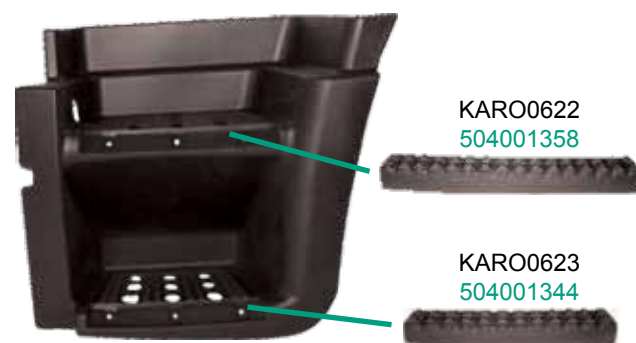

KARO0622
504001358

KARO0623
504001344



KARO0650
504056033



KARO0028
504056436



KARO0649
504056034



KARO0630
500383947



RASV0336
504238093



RASV0334
504238117



KARO0014
504065985



KARO0017
504065982



KARO0016
504074676



KARO0015
504065984



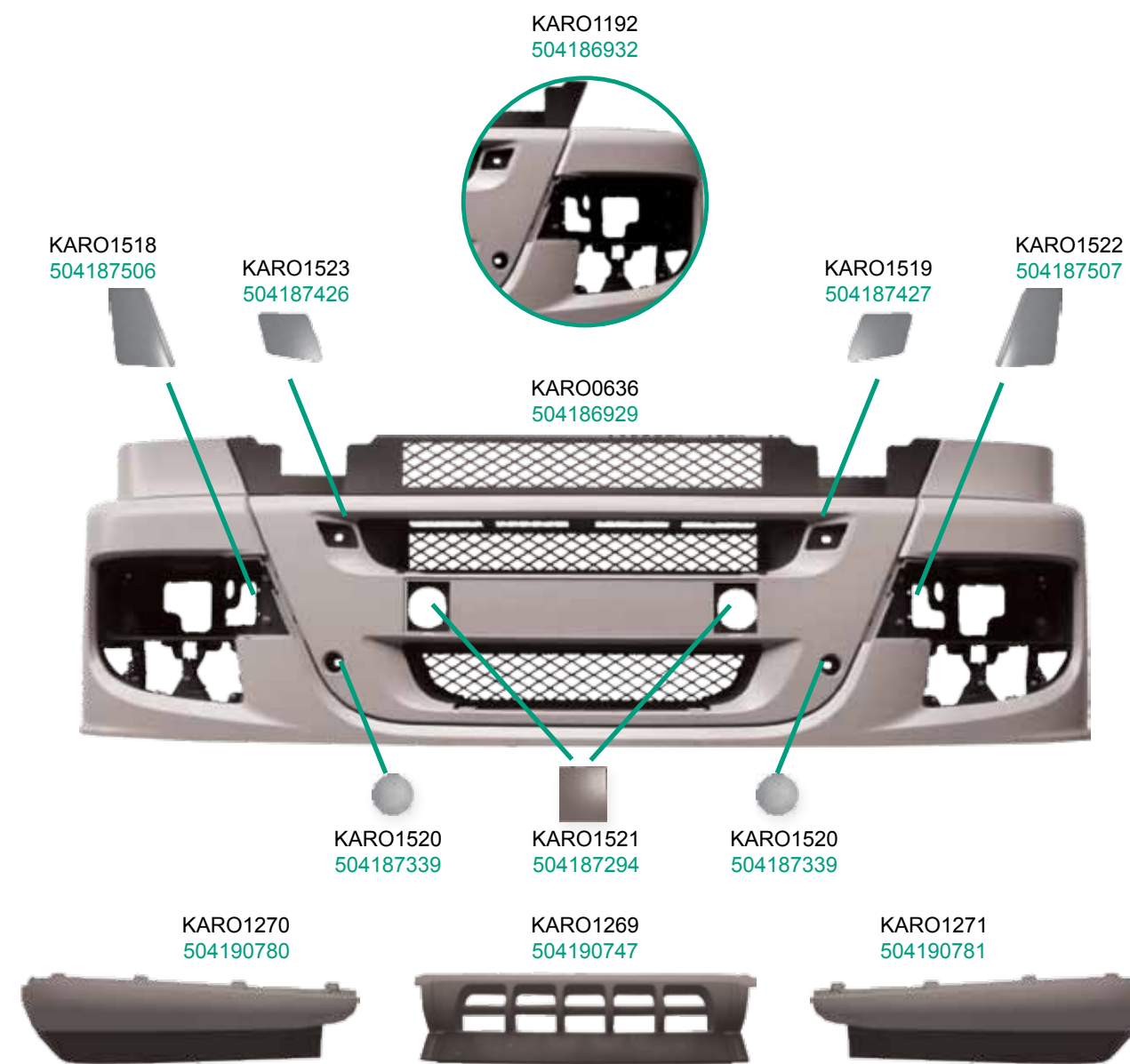



KARO1469
504170848 STRALIS AS 2007



RASV0336
504238093



RASV0907
42555041



RASV0908
42555042



RASV0334
504238117



KARO0701
504187939



KARO0703
504173478



KARO0704
504173477



KARO0702
504187940



RASV1125
504181096



RASV1126
504181095



RASV1126
504181095



RASV1125
504181096



KARO0706
504060280



KARO0707
504027461



KARO0705
504060281



KARO0708
504116080



KARO0709
504027614



KARO0710
504116081



KARO0711
504027613



RASV0336
504238093



RASV0334
504238117





KARO0712
504037735



KARO0713
504037737



KARO0714
504052236



KARO0715
504052237



KARO0716
504027536



KARO0718
504139860



KARO0719
504139861



KARO0706
504060280



KARO0707
504027461



KARO0705
504060281



KARO0708
504116080



KARO1376
504027620



KARO0710
504116081



KARO1615
500042692



RASV0336
504238093



RASV0334
504238117





KARO0724
504054942



KARO0725
504054943



KARO1395
504054940



KARO0723
504054941



KARO0726
504055140



KARO0727
504055141



KARO0718
504139860



KARO0719
504139861



KARO0728
504054989



KARO0729
504054990



KARO0730
504055010



KARO0731
504055011





STRALIS 480

Poz.	Naziv	OE broj	RAPIDEX broj
1.	SUNCOBRAN	504042824	KABI1365



STRALIS 430-450

Poz.	Naziv	OE broj	RAPIDEX broj
1.	SUNCOBRAN	504056838	KABI1366



DAILY IV



OE broj	Opis	Položaj	Grejač	Dimenzije (mm)	RAPIDEX broj
5801367608	KR	◀	☰	-	KABI1378
5801367641	KR	▶	☰	-	KABI1377
5801367571	DR	◀	☰	-	KABI1245
5801367568	DR	▶	☰	-	KABI1376
5801405677	-	◀▶	-	-	ELEK1477

EUROTECH, EUROSTAR, EUROTRAKKER (1993 - 2006), EUROCARGO (2000 - 2006), STRALIS (2002 - 2006)



OE broj	MEKRA broj	Opis	Položaj	Grejač	Dimenzije (mm)	RAPIDEX broj
98472977	51.4601.120H	☞	◀▶	☰	355 x 215 x 140	KABI0343
98409216	51.4601.235H	◀▶	◀▶	☰	355 x 215 x 140	KABI0233
93190970	15.4601.164H	☰	-	☰	340 x 200 x 14	KABI0489
93190971	20.4601.100H	☞	-	-	-	KABI0490

EUROTECH, EUROSTAR, EUROTRAKKER (1993 - 2006), EUROCARGO (2000 - 2006), STRALIS (2002 - 2006)



OE broj	MEKRA broj	Opis	Položaj	Grejač	Dimenzije (mm)	RAPIDEX broj
98472982	51.4612.120H	☞	◀▶	☰	457 x 215 x 140	KABI0232
98473011	51.4612.235H	◀▶	◀▶	☰	457 x 215 x 140	KABI0235
93190976	15.4611.164H	☰	-	☰	440 x 200 x 14	KABI0491
93190977	20.4611.100H	☞	-	-	-	KABI0492

EUROSTAR, EUROTRAKKER (1993 - 2006), EUROCARGO (2000 - 2006), STRALIS (2002 - 2006)



OE broj	MEKRA broj	Opis	Položaj	Grejač	Dimenzije (mm)	RAPIDEX broj
98473013	56.4622.200H	☞	◀▶	☰	189 x 215 x 140	KABI0229
98473014	56.4622.300H	◀▶	◀▶	☰	189 x 215 x 140	KABI0230
93190973	15.4622.164H	☰	-	☰	200 x 175 x 14	KABI0494
93190974	20.4621.100H	☞	-	-	-	KABI0495

EUROTECH, EUROSTAR, EUROTRAKKER (1993 - 2006), EUROCARGO (2000 - 2006), STRALIS (2002 - 2006)



OE broj	MEKRA broj	Opis	Položaj	Grejač	Dimenzije (mm)	RAPIDEX broj
98472974	59.4631.220H	☞	◀▶	☰	284 x 185 x 80	KABI0496
98472975	59.4631.320H	◀▶	◀▶	☰	284 x 185 x 80	KABI0497
93190984	15.4632.164H	☰	-	☰	260 x 160 x 10	KABI0498

EUROCARGO, STRALIS (2006 -)



OE broj	Opis	Položaj	Grejač	Dimenzije (mm)	RAPIDEX broj
504150526	KR	◀	☰	-	KABI1612
504150527	KR	▶	☰	-	KABI1611
504150538	SR	◀	☰	-	KABI1630
504150539	SR	▶	☰	-	KABI1631
504150551	DR	◀	☰	-	KABI0501
504150552	DR	▶	☰	-	KABI0502

EUROCARGO, STRALIS (2006 -)



OE broj	MEKRA broj	Opis	Položaj	Grejač	Dimenzije (mm)	RAPIDEX broj
504224428	55.1008.002.009	☞	▶	☰	232 x 136	KABI1118

LEGENDA:



MANUELNO
PODEŠAVANJE



STAKLO



GREJAČ

◀ LEVI POLOŽAJ



ELEKTRIČNO
PODEŠAVANJE



PLOKLOPAC
KUĆIŠTE



◀▶ UNIVERZALAN
POLOŽAJ

▶ DESNI POLOŽAJ

KR KRATKA RUKA

SR SREDNJA RUKA

DR DUGA RUKA



CILINDRI ZA DIZANJE KABINE

Poz.	Model vozila	OE broj	RAPIDEX broj
1.	STRALIS	504065532	KABI1332
			

PUMPE ZA DIZANJE KABINE

Poz.	Slika	Model vozila	OE broj	RAPIDEX broj
1.		EUROSTAR, EUROTRAKKER, STRALIS	99458304	HIDR0300

6.4 ELEMENTI ZA OSLANJANJE KABINE
ELEMENTI ZA OSLANJANJE KABINE

Poz.	Slika	Model vozila	Dimenzije (mm)	SEM broj	OE broj	RAPIDEX broj
1.		STRALIS	32 x 60,5 x 36	12821	500357265	KABI1815
2.		STRALIS	16 x 78 x 63	12820	500351393	KABI1260
3.		STRALIS	16 x 70 x 67,5	13212	504008198	KABI1770

UREĐAJI ZA PRANJE VETROBRANSKOG STAKLA

Poz.	Model vozila	Opis	OE broj	RAPIDEX broj
1.	EUROCARGO, STRALIS	MOTOR BRISAČA	99439637	ELEK0081
2.	TECTOR, STRALIS	PUMPICA BRISAČA	500304249	KABI1491
3.	DAILY	METILICE BRISAČA 600/600 mm SET	-	KABI1078
4.	STRALIS	METLICA BRISAČA 650 mm FLAT	-	OPRE0120
5.	STRALIS	METLICA BRISAČA 650 mm	-	KABI1574

MEHANIZAM VRATA

Poz.	Model vozila	Opis	Položaj	OE broj	RAPIDEX broj
1.	EUROCARGO, STRALIS	KVAKA VRATA	▶	-	KABI0464
2.	EUROCARGO, STRALIS	KVAKA VRATA	◀	-	KABI0465
3.	EUROCARGO, STRALIS	KVAKA VRATA KPL	◀▶	504052936	KABI1532
4.	EUROCARGO, STRALIS	PODIZAČ PROZORA ELEKTRONSK	▶	99487780	KABI0851
5.	EUROCARGO, STRALIS	PODIZAČ PROZORA ELEKTRONSK	◀	99487781	KABI0815

6.7 PREKIDAČI

Slika	Poz.	Model vozila	Opis	OE broj	RAPIDEX broj
	1.	STRALIS	MENJAČA	504107503	ELEK2228
	2.	STRALIS	MENJAČA NEUTRALA	504107501	ELEK2217
	3.	STRALIS	MENJAČA RIKVERC	504107504	ELEK2227
	4.	STRALIS	ZAVESE	504096438	ELEK2230
	5.	STRALIS	ROTACIJE	504096596	ELEK2330

7.0 ELEKTRIČNE INSTALACIJE



7.0 ELEKTRIČNE INSTALACIJE

7.1	Farovi	146
7.2	Pokazivači pravca	151
7.3	Stop i gabaritna svetla	153
7.4	Rotacione lampe	157
7.5	Sijalice, osigurači i tahograf listići	160
7.6	Kablovi električne instalacije	165
7.7	Kombinovani prekidači pod volanom	168
7.8	Pribori	169
7.9	Anlaseri i alternatori	170

DAILY (1989 - 1999)

OE broj	OPIS	RAPIDEX broj
98433943	▶ H4	RASV0603
98433942	◀ H4	RASV0604
98433940	▶ H4	RASV0605
98433939	◀ H4	RASV0606



98438671	▶ H3	RASV0607
98438672	◀ H3	RASV0608

DAILY (1999 - ...)

OE broj	OPIS	RAPIDEX broj
500307754	▶ H7 H1	RASV0609
500307755	◀ H7 H1	RASV0610



500320684	▶ H3	RASV0611
500320685	◀ H3	RASV0612

DAILY (2006 - ...)

OE broj	OPIS	RAPIDEX broj
69500010	▶ H7 H1	RASV0613
69500013	◀ H7 H1	RASV0614

DAILY (2012 - ...)

OE broj	OPIS	RAPIDEX broj
5801375415	▶ H7 H1	RASV1320
5801375416	◀ H7 H1	RASV1321

EUROCARGO (1991 - 2002)

OE broj	OPIS	RAPIDEX broj
500340503	▶ H4	RASV0615
500340543	◀ H4	RASV0616
500340361	▶ H4	RASV0617
500340408	◀ H4	RASV0618

EURO CARGO, EURO STAR, EURO TECH (1991 - 2002)

OE broj	OPIS	RAPIDEX broj
98437475	▶ H3 H3	RASV0619
98437476	◀ H3 H3	RASV0620

EURO STAR, EURO TECH (1993 - 2002)

OE broj	OPIS	RAPIDEX broj
4861793	▶ H4 H3	RASV0621
4861794	◀ H4 H3	RASV0622
500305102	▶ H4 H3	RASV0017
500305103	◀ H4 H3	RASV0287

**EURO CARGO (2004 - ...)
STRALIS (2003 - ...)**



OE broj	OPIS	RAPIDEX broj
504020189	▶ H7 H7	RASV1033
504020193	◀ H7 H7	RASV1032
41221015	▶ H7 H7	RASV0336
41221036	◀ H7 H7	RASV0334

STRALIS (2013 - ...)



OE broj	OPIS	RAPIDEX broj
5801639122	 LED  H7  H7	RASV1560
5801639118		RASV1561



STRALIS (2003 - ...)

OE broj	OPIS	RAPIDEX broj
504032145	  H1	RASV1007

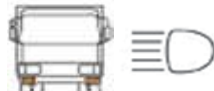

OE broj	OPIS	RAPIDEX broj
41221084	  H1	RASV1006

STRALIS (2007 - ...)

OE broj	OPIS	RAPIDEX broj
504181095	  H1	RASV1126



OE broj	OPIS	RAPIDEX broj
504181096	  H1	RASV1125

STRALIS (2007 - ...)

OE broj	OPIS	RAPIDEX broj
-	  H1  H1	RASV1499
		RASV1498



UNIVERZALNI FAR



KBP	OPIS	RAPIDEX broj
1G3 005 760-021	  H3 Ø152 mm	RASV0718



UNIVERZALNI FAR



KBP	OPIS	RAPIDEX broj
1GA 005 060-001	  H3 153 x 93 mm	RASV0230



UNIVERZALNI FAR



KBP	OPIS	RAPIDEX broj
1GA 006 991-021	  H3 158 x 105 mm	RASV0719

UNIVERZALNI FAR



KBP	OPIS	RAPIDEX broj
1GA 006 991-081 44.120.000	  H3 112 x 102mm	RASV0168

UNIVERZALNI FAR

KBP	OPIS	RAPIDEX broj
44.040.500	 H3 170 x 100 mm	RASV0167

LED UNIVERZALNI FAR

KBP	OPIS	RAPIDEX broj
91017420	 LED 9-30 V, 1200 LUMENA 105 x 124	RASV0546

LED UNIVERZALNI FAR

KBP	OPIS	RAPIDEX broj
098174090	 LED 9-30 V, 1200 LUMENA 140 x 114	RASV1342

EUROCAGO (1991 - 2002)

OE broj	OPIS	RAPIDEX broj
4855967		RASV0727
4855968		RASV0728



500340695		RASV0729
500340696		RASV0730

EUROCARGO (2003 - ...)

OE broj	OPIS	RAPIDEX broj
504047573		RASV0731

EUROCARGO, STRALIS (2007 - ...)

OE broj	OPIS	RAPIDEX broj
42555041		RASV0907
42555042		RASV0908

EUROSTAR (1993 - 2002)

OE broj	OPIS	RAPIDEX broj
98449181		RASV0732
98449182		RASV0733

STRALIS (2003 - ...)

OE broj	OPIS	RAPIDEX broj
41221040		RASV1003
41221041		RASV1002

EUROCARGO (1991 - ...)



OE broj	OPIS	RAPIDEX broj
500316547		RASV0741

EUROCARGO (2003 - ...)



OE broj	OPIS	RAPIDEX broj
500367925		RASV0742

EUROTECH



OE broj	OPIS	RAPIDEX broj
500368110		RASV0743
500368111		RASV0744

STRALIS (2003 - ...)



OE broj	OPIS	RAPIDEX broj
41221029		RASV1277
41221039		RASV0161

3 RUPE

STRALIS (2003 - ...)



OE broj	OPIS	RAPIDEX broj
504098243		RASV1302
504098245		RASV1301

2 RUPE

DAILY (1999 - ...)



OE broj	OPIS	RAPIDEX broj
500356782		RASV1123
500356783		303 x 130 mm

DAILY (2006 - ...)



OE broj	OPIS	RAPIDEX broj
69500590		RASV1161
69500591		RASV1343

DAILY (2006 - ...)



OE broj	OPIS	RAPIDEX broj
69500026		RASV1344
69500032		304 x 130 mm

EUROCARGO, EUROSTAR, EUROTECH, EUROTRAKKER, STRALIS







OE broj	OPIS	RAPIDEX broj	
99463242		RASV1108	
99463244		+ sv.reg.tablice	RASV0300
99463243		468 x 134 mm	RASV0312
93161844	► STAKLO ◄ STAKLO	RASV0306	

RIKVERC ALARMI

Poz.	Slika	Naziv / Opis	RAPIDEX broj
1.		RIKVERC ALARM 12/24 V, 97 dB	OSTA0370
2.		RIKVERC ALARM 12/24 V, 97 dB	OSTA0247

EUROCARGO, EUROSTAR, EUROTECH, STRALIS

	OE broj		OPIS	RAPIDEX broj
	98461649	▶	24V	RASV0830
	98464648	◀	T4W-Ba9S	RASV0831
	500314717	▶	24V	RASV0832
	500314716	◀	T4W-Ba9S	RASV0833
	41200664	▶	crni konektor	RASV1374
		◀	24V W5W- W2,1X9,5D	
	500308514	▶	beli konektor	RASV1231
		◀	24V W5W- W2,1X9,5D	

STRALIS

	OE broj		OPIS	RAPIDEX broj
	504047264	▶	24V	RASV0834
	504047265	◀	T4W-Ba9S	RASV0835

SVETLA REGISTRAR TABLICE

	KBP	OPIS	RAPIDEX broj
	2KA 003 389-061	▶ 12/24V R10W-Ba15s ◀	RASV0396
	26-3010-004	▶ 12/24V C5W-SV8,5 ◀	RASV0075
	26-3000-004	▶ 12/24V C5W-SV8,5 ◀	RASV0105
	-	▶ LED ◀	RASV0521
	-	▶ LED ◀	RASV1440



KATADIOPTERI

KBP	OPIS		RAPIDEX broj
8RA 002 014-041	BELI	Ø 60 mm	RASV0861
8RA 002 014-051	ŽUTI		RASV0459
8RA 002 014-031	CRVENI		RASV0460
8RA 003 326-021	BELI	94 x 44 mm	RASV0458
8RA 003 326-011	ŽUTI		RASV0457
8RA 003 326-001	CRVENI		RASV0410
01.090.7520.05			RASV0222



KL 7000 F



KBP	OPIS		RAPIDEX broj
2RL 008 061-101	12V	H1	RASV0862
2RL 008 061-111	24V		RASV0863
9EL 862 141-001	ŽUTO STAKLO		RASV0864
9EL 862 140-001	PLAVO STAKLO		RASV0865

KL 7000 M



KBP	OPIS		RAPIDEX broj
2RL 008 062-101	12/24V	H1	RASV0866
2RL 008 062-111	24/12V		RASV0867
9EL 862 141-001	ŽUTO STAKLO		RASV0864
9EL 862 140-001	PLAVO STAKLO		RASV0865

KL 7000 M



KBP	OPIS		RAPIDEX broj
2RL 008 062-001	12/24V	H1	RASV0868
2RL 008 062-011	24/12V		RASV0869
9EL 862 141-001	ŽUTO STAKLO		RASV0864
9EL 862 140-001	PLAVO STAKLO		RASV0865

KL 7000 R

KBP	OPIS	RAPIDEX broj
2RL 008 060-101	12/24V	 H1 RASV0870
2RL 008 060-111	24/12V	
9EL 862 141-001	ŽUTO STAKLO	RASV0864
9EL 862 140-001	PLAVO STAKLO	RASV0865

JUNIOR PLUS F

KBP	OPIS	RAPIDEX broj
2RL 008 965-001	12V	 H1 RASV0467
2RL 008 965-011	24V	
9EL 863 100-001	ŽUTO STAKLO	RASV0873

JUNIOR F

KBP	OPIS	RAPIDEX broj
2RL 007 550-001	12V	 H1 RASV0533
2RL 007 550-011	24V	
9EL 860 627-001	ŽUTO STAKLO	RASV0505
9EL 860 628-021	PLAVO STAKLO	RASV0874

JUNIOR M

KBP	OPIS	RAPIDEX broj
2RL 007 552-001	12V	 H1 RASV0560
2RL 007 552-011	24V	
9EL 860 627-001	ŽUTO STAKLO	RASV0505
9EL 860 628-021	PLAVO STAKLO	RASV0874

JUNIOR R

KBP	OPIS	RAPIDEX broj
2RL 007 551-001	12V	 H1 RASV0055
2RL 007 551-011	24V	
9EL 860 627-001	ŽUTO STAKLO	RASV0505
9EL 860 628-021	PLAVO STAKLO	RASV0874

H1 - P14,5s

OPIS	RAPIDEX broj
12V H1-55W	RASV1089
24V H1-70W	RASV1088

H2 - H511

OPIS	RAPIDEX broj
12V H2-55W	RASV0880
24V H2-70W	RASV0881

H3 - PK22s

OPIS	RAPIDEX broj
12V H3-55W	RASV1105
24V H3-70W	ELEK0294

H4 - P43t

OPIS	RAPIDEX broj
12V H4-60/55W	RASV1085
24V H4-75/70W	ELEK0295

H7 - Px26d

OPIS	RAPIDEX broj
12V H7-55W	RASV1084
24V H7-70W	RASV1078

H8 - PGJ19-1

OPIS	RAPIDEX broj
12V H8-35W	RASV0882

H9 - PGJ19-5

OPIS	RAPIDEX broj
12V H9-55W	RASV0877

H10 - PY20d

OPIS	RAPIDEX broj
12V H10-42W	RASV0883

H11 - PGJ19-2

OPIS	RAPIDEX broj
12V H11-55W	RASV0878
24V H11-70W	RASV0879

H21W - BAY9s

OPIS	RAPIDEX broj
12V H21W	RASV0884
24V H21W	RASV1079

D2R - P32d3

OPIS	RAPIDEX broj
D2R-35W	RASV0885

D2S - P32d2

OPIS	RAPIDEX broj
D2S-35W	RASV0886

R2 - P45t

OPIS	RAPIDEX broj
12V R2-45/40W	RASV0550
24V R2-55/50W	RASV0571

P21W - BA15s

OPIS	RAPIDEX broj
12V P21W	RASV1083
24V P21W	ELEK0293

PY21W - BAU15s

OPIS	RAPIDEX broj
12V PY21W	RASV0562
24V PY21W	RASV0499

P21/5W - BAY15d

OPIS	RAPIDEX broj
12V P21/5W	RASV0535
24V P21/5W	RASV1076

R5W - BA15s

OPIS	RAPIDEX broj
12V R5W	RASV1082
24V R5W	RASV1072

R10W - BA15s

OPIS	RAPIDEX broj
12V R10W	RASV0490
24V R10W	RASV1075

C5W - SV8,5

OPIS	RAPIDEX broj
12V C5W	RASV0887
24V C5W	RASV1074

C10W - SV8,5

OPIS	RAPIDEX broj
12V C10W	RASV0888
24V C10W	RASV0315

T3W - BA9s

OPIS	RAPIDEX broj
12V T3W	RASV0502
24V T3W	RASV0501

T4W - BA9s

OPIS	RAPIDEX broj
12V T4W	ELEK0291
24V T4W	RASV1071

W3W - W2,1x9,5d

OPIS	RAPIDEX broj
12V W3W	RASV0564
24V W3W	RASV0569

W5W - W2,1x9,5d

OPIS	RAPIDEX broj
12V W5W	RASV0484
24V W5W	RASV1073

W1,2W - W2x4,6d

OPIS	RAPIDEX broj
12V W1,2W	RASV0563
24V W1,2W	RASV1069

W1,2W - B8,3d

OPIS	RAPIDEX broj
12V W1,2W	RASV0893
24V W1,2W	RASV1070

GARNITURA SIJALICA H7

OPIS	RAPIDEX broj
12V H7	RASV1180
24V H7	RASV1081

GARNITURA SIJALICA H4

OPIS	RAPIDEX broj
12V H4	RASV1086
24V H4	RASV1080

GARNITURA SIJALICA H7

OPIS	RAPIDEX broj
2 x 24V H7	RASV0892

GARNITURA SIJALICA H4

OPIS	RAPIDEX broj
2 x 24V H4	RASV0895

OSIGURAČI UBODNI

Slika	Poz.	Opis	KBP	RAPIDEX broj
	1.	5A OKER	8JS 711 684-002	ELEK0684
	2.	7,5A BRAON	8JS 711 685-002	ELEK0258
	3.	10A CRVENI	8JS 711 686-002	RASV0568
	4.	15A PLAVI	8JS 711 687-002	RASV0567
	5.	20A ŽUTI	8JS 711 688-002	ELEK0257
	6.	25A BELI	8JS 711 689-002	ELEK0575
	7.	30A ZELENI	8JS 711 690-002	RASV0539
	8.	40A NARANDŽASTI	8JS 711 683-031	ELEK0769

OSIGURAČI UBODNI - MINI

Slika	Poz.	Opis	KBP	RAPIDEX broj
	1.	5A	8JS 728 596-131	RASV0183
	2.	7,5A	8JS 728 596-111	RASV0184
	3.	10A	8JS 728 596-141	RASV0185
	4.	15A	8JS 728 596-151	RASV0186
	5.	20A	8JS 728 596-161	RASV0187
	6.	25A	8JS 728 596-091	RASV0188
	7.	30A	8JS 728 596-171	RASV0189

OSIGURAČI UBODNI - MAXI

Slika	Poz.	Opis	KBP	RAPIDEX broj
	1.	20A	8JS 728 595-051	RASV0920
	2.	30A	8JS 728 595-141	RASV0921
	3.	40A	8JS 728 595-151	RASV0922
	4.	50A	8JS 728 595-161	RASV0923
	5.	60A	8JS 728 595-171	RASV0924
	6.	70A	8JS 728 595-101	RASV0925
	7.	80A	8JS 728 595-111	RASV0927

OSIGURAČI - MIDI

Slika	Poz.	Opis	KBP	RAPIDEX broj
	1.	30A	8JS 742 901-061	RASV0928
	2.	50A	8JS 742 901-011	RASV0929
	3.	150A	8JS 742 901-081	RASV0052

OSIGURAČI - MEGA

Slika	Poz.	Opis	KBP	RAPIDEX broj
	1.	125A	8JS 742 902-011	RASV0930
	2.	150A	8JS 742 902-021	RASV0931
	3.	200A	8JS 742 902-041	RASV0932
	4.	250A	8JS 742 902-051	RASV0933
	5.	300A	8JS 742 902-071	RASV0934

TAHOGRAF LISTIĆI

Slika	Poz.	Opis	RAPIDEX broj
	1.	100-24 EC4K	OPRE0210
	2.	100-3300-24 EC4	OPRE0220
	3.	125-24 EC4K	OPRE0224
	4.	125-3300-24 EC4KA	OPRE0122
	5.	140-24 EC4K	OPRE0216
	6.	SERTIFIKAT-VIKEND	OPRE0105
	7.	ROLNICA ZA DIGITALNI TAHOGRAF	ELEK1112

SPIRALNI KABLOVI

Slika	Poz.	Opis	KBP	RAPIDEX broj
	1.	7 - ŽILNI	611 110	ELEK0609
	2.	ISO 1724 7 - lni	8KA 004 797-021	ELEK0770
	3.	ISO 1185 7 - lni	8KA 004 797-041	ELEK0287
	4.	ISO 3731 7 - lni	8KA 004 797-051	ELEK0370
	5.	ISO 7638 ABS/EBS	446 008 700 0	ELEK1368
	6.	ISO 12098 15 - lni	446 008 710 0	ELEK1122
	7.	15/2 x 7 - lni	8JA 005 952-041	ELEK0450

ADAPTER				
Slika	Poz.	Opis	KBP	RAPIDEX broj
	1.	15/2 x 7 - lin	8JA 005 952-061	ELEK0247

UTIKAČI				
Slika	Poz.	Opis	KBP	RAPIDEX broj
	1.	ISO 1724 7 - Ini 12V	8JA 001 930-003	ELEK0607
	2.	ISO 1185 7 - Ini	8JA 008 831-001	RASV0541
	3.	ISO 3731 7 - Ini	8JA 008 832-011	ELEK0491
	4.	ISO 7638 ABS/EBS	8JB 007 645-031	ELEK0470
	5.	ISO 12098 15 - Ini	8JA 007 241-031	ELEK0250

UTIČNICE				
Slika	Poz.	Opis	KBP	RAPIDEX broj
	1.	ISO 1724 7 - Ini 12V	8JB 001 943-003	ELEK0606
	2.	ISO 1185 7 - Ini	8JB 003 833-001	RASV0513
	3.	ISO 3731 7 - Ini	8JB 003 834-001	RASV0452
	4.	ISO 7638 ABS/EBS	8JB 007 645-031	ELEK0402
	5.	ISO 12098 15 - Ini	8JB 007 242-011	ELEK0249

KOMBINOVANI PREKIDAČI POD VOLANOM				
Slika	Poz.	Model vozila	OE broj	RAPIDEX broj
	1.	DAILY	2997140	ELEK0383
	2.	STRALIS	41221035	ELEK0169



PRIBORI		
Slika	Opis	RAPIDEX broj
	Kablovi za startovanje 25 mm ² x 3,5 m	ELEK0554
	Kablovi za startovanje 35 mm ² x 4,5 m	ELEK0703
	Kablovi za startovanje 50 mm ² x 7 m	ELEK0704
	Kontakt klešta 25 - 50 mm ²	ELEK0705
	Klemna +	ELEK0640
	Klemna -	ELEK0600
	Merač kiseline	ELEK0706

EUROCARGO				
Slika	Opis	KBP	OE broj	RAPIDEX broj
	24 V 4 kW 10 Z	860716	2995986	ELEK1904

STRALIS				
Slika	Opis	KBP	OE broj	RAPIDEX broj
	24 V 5,5 kW 12 Z	M009T61671	504042667	ELEK1897

STRALIS				
Slika	Opis	KBP	OE broj	RAPIDEX broj
	24 V 5,5 kW 10 Z	DSN940	99486046	ELEK1768

EUROCARGO, EUROSTAR, EUROTECH, EUROTRAKKER				
Slika	Opis	KBP	OE broj	RAPIDEX broj
	28V 80A	0 120 468 124	98424453	ELEK0711

EUROCARGO, EUROTECH, EUROTRAKKER, STRALIS				
Slika	Opis	KBP	OE broj	RAPIDEX broj
	28V 90A PK8 Ø 55 mm	0 124 555 005	42498713	ELEK1964
	28V 90A PK10 Ø 62 mm	0 123 525 500	500331736	ELEK0722
	28V 90A PK12 Ø 68 mm	A004TA0594	504349338	ELEK1646



8.0 PRIBORI



8.0 PRIBORI

8.1 Obeležavajuće table i pribori A.D.R.	174
8.2 Oprema	189
8.3 Pribor za osiguravanje tereta	192
8.4 Lanci za sneg	194
8.5 Vučne kuke	196
8.6 Grejanje kabine	199

REFLEKTUJUĆE I FLUOROSCENTNE TABLE ZA KAMIONE SAGLASNO REGULATIVI ECE 70

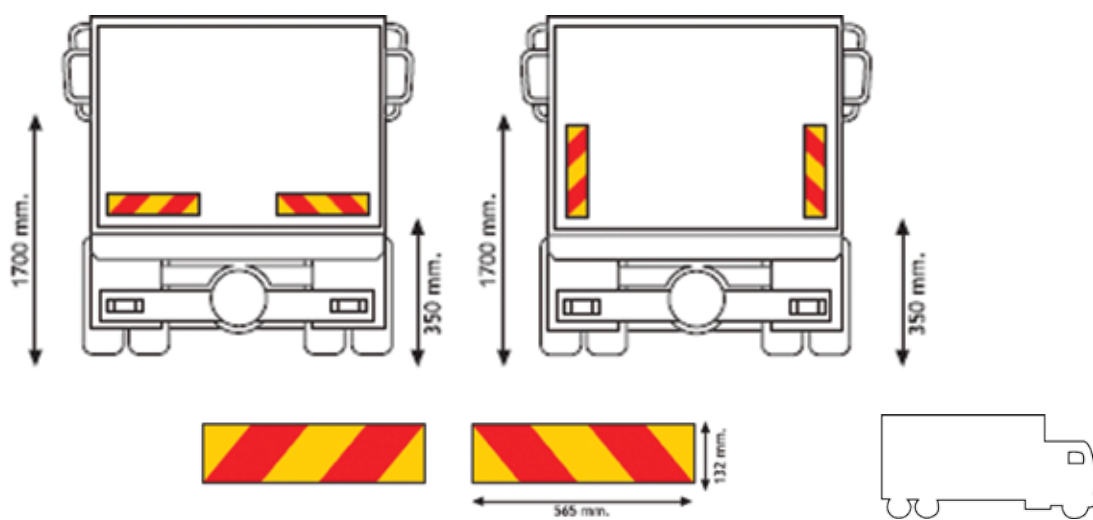

Poz.	Dimenzije (mm)	Opis	Jedinica mere	RAPIDEX broj
1.	565 x 132	Aluminijum	PAR	OPRE0097

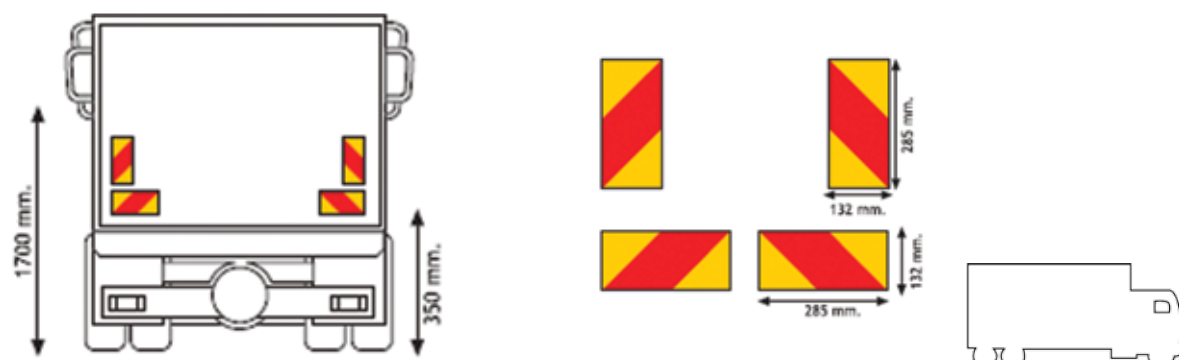

Poz.	Dimenzije (mm)	Opis	Jedinica mere	RAPIDEX broj
2.	285 x 132	Aluminijum	PAR	OPRE0260

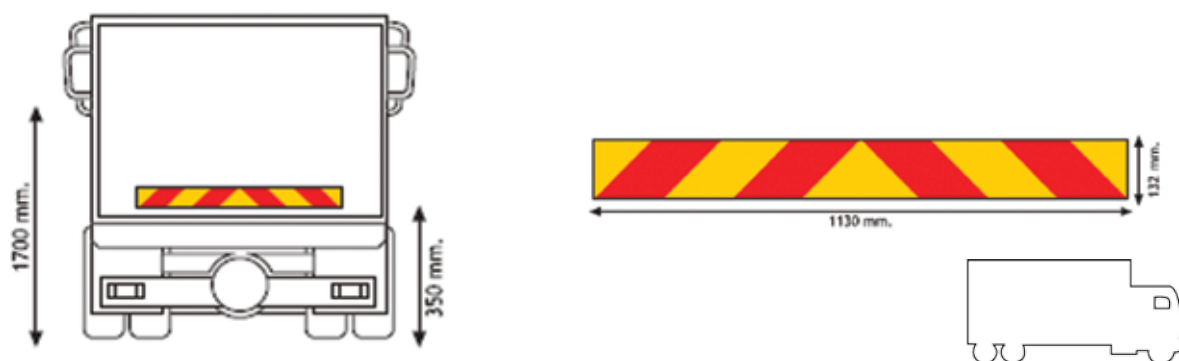

Poz.	Dimenzije (mm)	Opis	Jedinica mere	RAPIDEX broj
3.	1130 x 196	Aluminijum	KOM	OPRE0261

REFLEKTUJUĆE I FLUOROSCENTNE TABLE ZA KAMIONE SAGLASNO REGULATIVI ECE 70

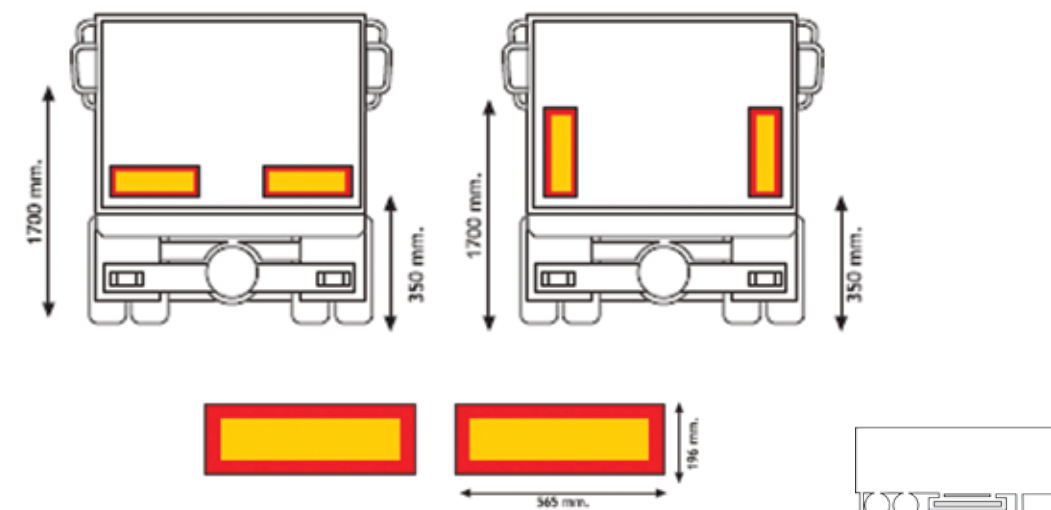

Poz.	Dimenzije (mm)	Opis	Jedinica mere	RAPIDEX broj
1.	565 x 196	Aluminijum	PAR	OPRE0157

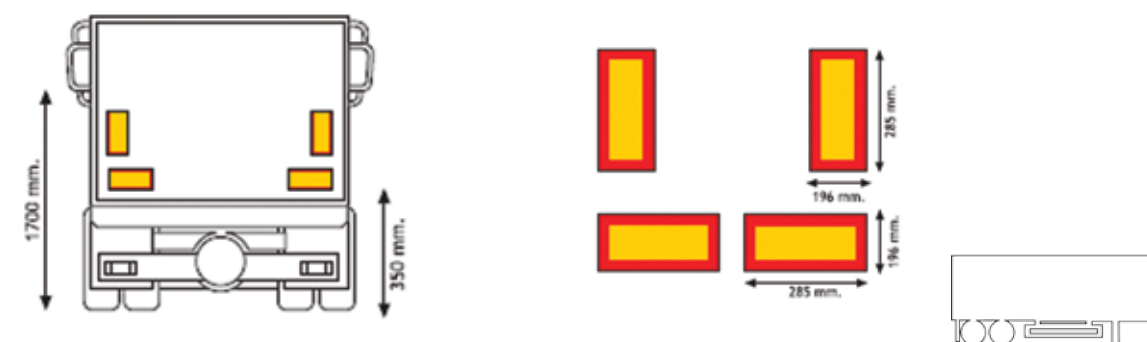

Poz.	Dimenzije (mm)	Opis	Jedinica mere	RAPIDEX broj
2.	285 x 196	Aluminijum	PAR	OPRE0262

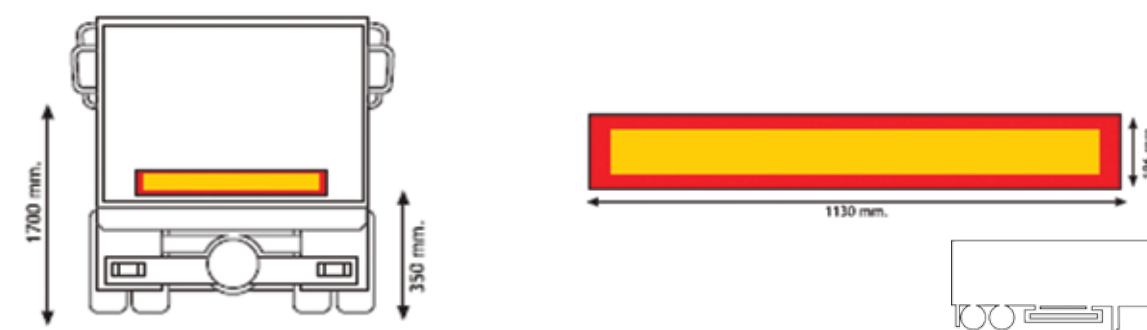

Poz.	Dimenzije (mm)	Opis	Jedinica mere	RAPIDEX broj
3.	1130 x 196	Aluminijum	KOM	OPRE0090

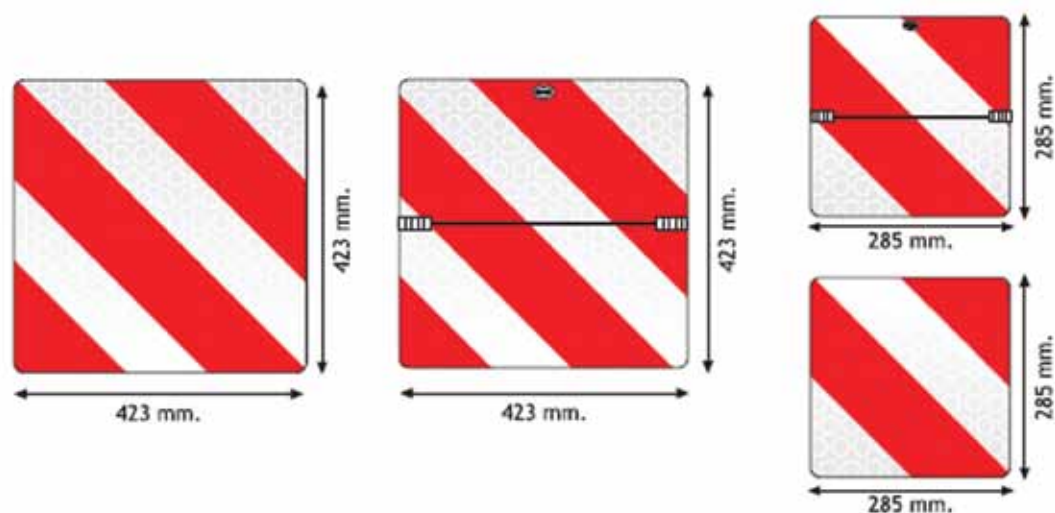
**REFLEKTUJUĆE TABLE ZA PREVOZ TERETA
VAN DOZVOLJENIH GABARITA**

Poz.	Dimenzije (mm)	Opis	Jedinica mere	RAPIDEX broj
1.	423 x 423	Aluminijum / Panel	kom	OPRE0142
2.	423 x 423	Aluminijum / Preklopiva	kom	OPRE0263
3.	285 x 285	Aluminijum / Preklopiva	kom	OPRE0265
4.	285 x 285	Aluminijum / Panel	kom	OPRE0264

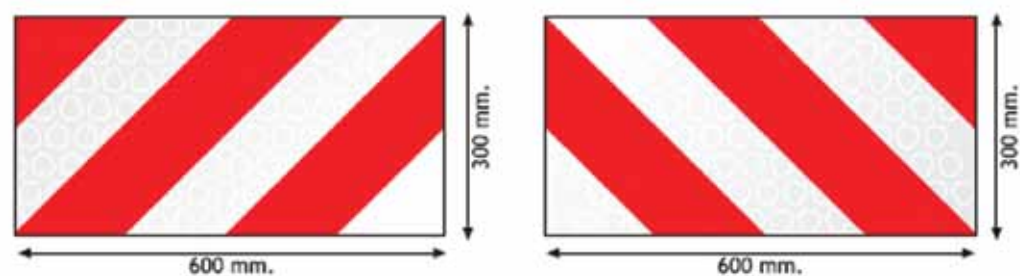

Poz.	Dimenzije (mm)	Opis	Jedinica mere	RAPIDEX broj
5.	600 x 300	Aluminijum / Panel	set	OPRE0266

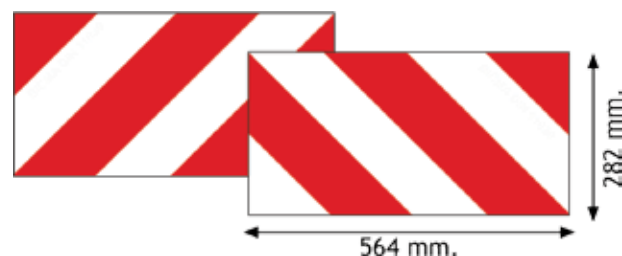

Poz.	Dimenzije (mm)	Opis	Jedinica mere	RAPIDEX broj
6.	564 x 282	Aluminijum / Panel	set	OPRE0267

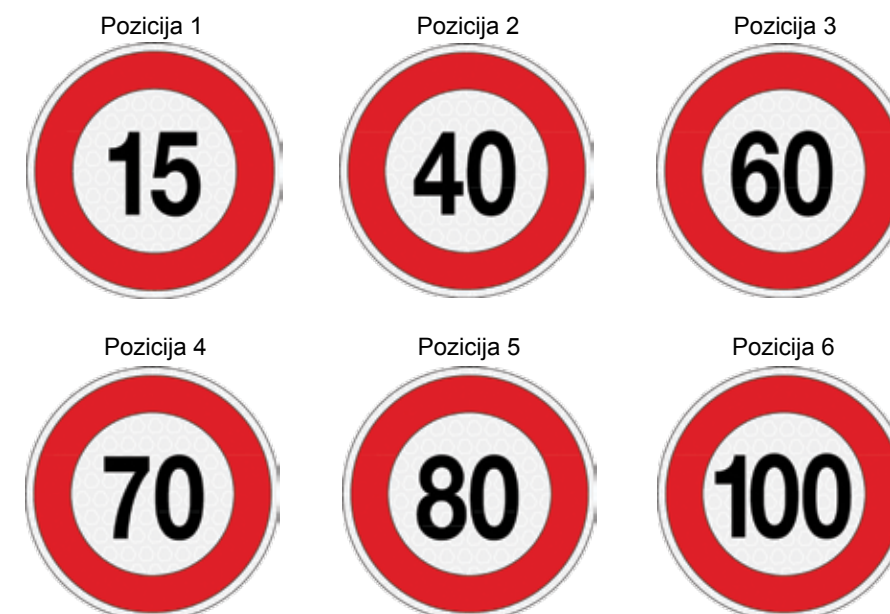
REFLEKTUJUĆE TABLE OGRANIČENJA BRZINE

Poz.	Dimenzije (mm)	Opis	RAPIDEX broj
1.	Ø 200	Nalepnica	OPRE0268
		Aluminijum	OPRE0269
2.	Ø 200	Nalepnica	OPRE0270
		Aluminijum	OPRE0271
3.	Ø 200	Nalepnica	OPRE0272
		Aluminijum	OPRE0273
4.	Ø 200	Nalepnica	OPRE0274
		Aluminijum	OPRE0275
5.	Ø 200	Nalepnica	OPRE0276
		Aluminijum	OPRE0277
6.	Ø 200	Nalepnica	OPRE0278
		Aluminijum	OPRE0279

OZNAČAVAJUĆE TABLE ZA PREVOZ DECE

Poz.	Dimenzije (mm)	Opis	RAPIDEX broj
1.	400 x 400	Aluminijum	OPRE0280
2.	400 x 400	Aluminijum / Preklopiva - Horizontalno	OPRE0089
3.	400 x 400	Nalepnica	OPRE0282

IDENTIFIKACIONE OZNAKE VOZILA

Poz.	Dimenzije (mm)	Opis	RAPIDEX broj
1.	Ø 200	Aluminijum	OPRE0283
2.	Ø 200	Aluminijum	OPRE0284
3.	Ø 200	Aluminijum	OPRE0285
4.	Ø 200	Aluminijum	OPRE0286
5.	Ø 200	Aluminijum	OPRE0055
6.	Ø 200	Aluminijum	OPRE0056
7.	Ø 200	Aluminijum	OPRE0057



Poz.	Dimenzije (mm)	Opis	RAPIDEX broj
1.	Ø 200	Aluminijum	OPRE0287
2.	Ø 200	Aluminijum	OPRE0288
3.	Ø 200	Aluminijum	OPRE0289



Poz.	Dimenzije (mm)	Opis	RAPIDEX broj
1.	400 x 250	Aluminijum	OPRE0290
2.	400 x 250	Aluminijum / Preklopiva - Horizontalno	OPRE0154
3.	400 x 250	Aluminijum / Preklopiva - Vertikalno	OPRE0291

UPOZORAVAJUĆE TABLE HIDRAULIČNIH ZADNJIH VRATA

Poz.	Opis	RAPIDEX broj
1.	Aluminijumska tabla / desna strana	OPRE0292
2.	Aluminijumska tabla / leva strana	OPRE0293
3.	Aluminijumska tabla sa nosačem / desna strana	OPRE0294
4.	Aluminijumska tabla sa nosačem / leva strana	OPRE0295
5.	Aluminijumske table sa nosačima / desna i leva strana - set	OPRE0296

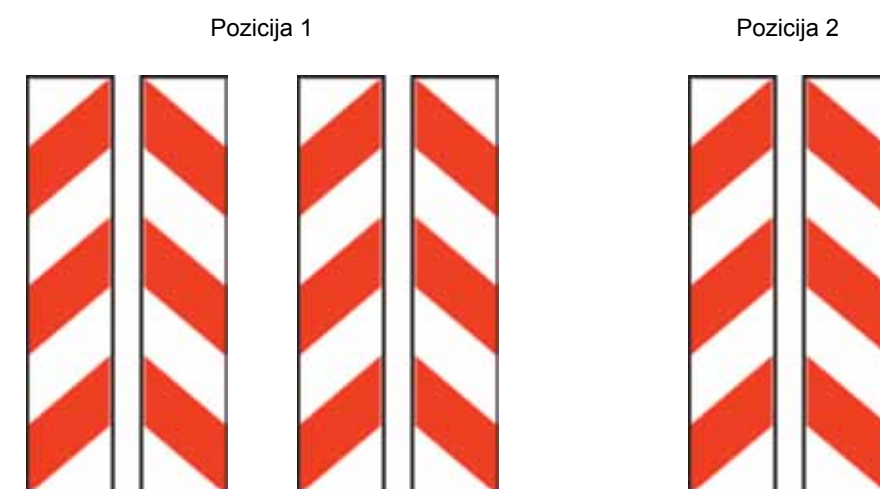
**IDENTIFIKACIONE TABLE ZA VOZILA I KONTEJNERE
SAGLASNO REGULATIVI DIN 67520**

Poz.	Dimenzije (mm)	Opis	RAPIDEX broj
1.	141 x 705	Aluminijum / SET (4 desne + 4 leve table)	OPRE0297
2.	141 x 705	Aluminijum / SET (1 desne + 1 leve table)	OPRE0298

REFLEKTUJUĆE TRAKE ZA VOZILA
SAGLASNO REGULATIVI EEC U.N.104



Poz.	Opis	RAPIDEX broj
1.	Reflektujuća traka žute boje 50 mm x 50 m	OSTA1056
2.	Reflektujuća traka crvene boje 50 mm x 50 m	OSTA1057
3.	Reflektujuća traka bele boje 50 mm x 50 m	OSTA1058



Poz.	Opis	RAPIDEX broj
1.	Reflektujuća traka žute boje 50 mm x 50 m	OSTA1055
2.	Reflektujuća traka crvene boje 50 mm x 50 m	OSTA1054
3.	Reflektujuća traka bele boje 50 mm x 50 m	OSTA1053

REFLEKTUJUĆE TRAKE ZA VOZILA
SAGLASNO REGULATIVI EEC U.N.104

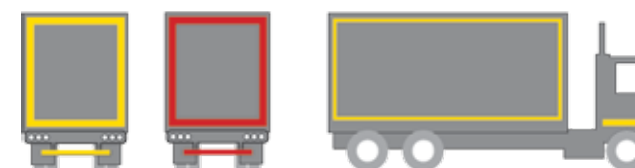
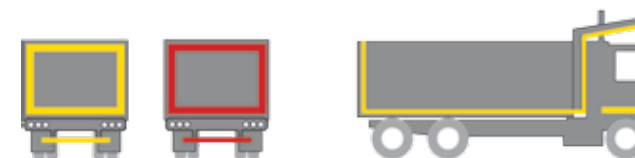
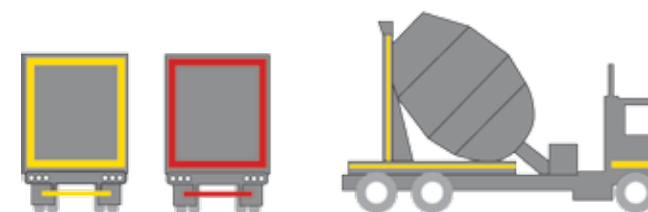
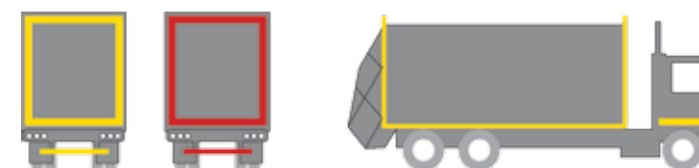
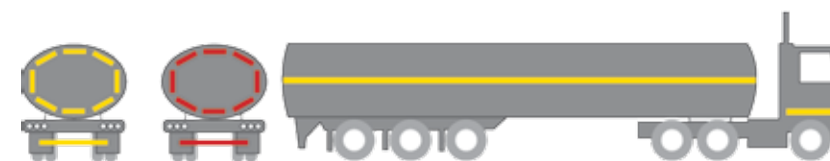

TABLE A.D.R.



Poz.	Dimenzije (mm)	Opis	RAPIDEX broj
1.	400 x 300	Aluminijum	OPRE0153
2.	400 x 300	Aluminijum / Preklopiva - Vertikalno	OPRE0152
3.	400 x 300	Aluminijum / Preklopiva - Horizontalno	OPRE0302



Poz.	Dimenzije (mm)	Opis	RAPIDEX broj
1.	400 x 300	30 - 1202 - Dizel	OPRE0035
2.	400 x 300	33 - 1203 - Benzin	OPRE0036
3.	400 x 300	30 - 1223 - Kerozin	OPRE0037
4.	400 x 300	23 - 1965 - LPG	OPRE0038
5.	400 x 300	23 - 1978 - Propan	OPRE0039
6.	400 x 300	23 - 1971 - Prirodni gas	OPRE0040
7.	400 x 300	23 - 1951 - Tečni argon	OPRE0041
8.	400 x 300	22 - 1977 - Tečni azot	OPRE0042
9.	400 x 300	22 - 2187 - Tečni CO ₂	OPRE0043
10.	400 x 300	223 - 1966 - Tečni vodonik	OPRE0044
11.	400 x 300	225 - 1073 - Tečni kiseonik	OPRE0045
12.	400 x 300	263 - 1040 - Etilenoksid	OPRE0046
13.	400 x 300	23 - 1011 - Butan	OPRE0047
14.	400 x 300	223 - 1038 - Tečni etilen	OPRE0048
15.	400 x 300	223 - 1972 - Tečni prirodni gas	OPRE0049
16.	400 x 300	30 - 1202 - Dizel / Preklopiva - Horizontalno	OPRE0052
17.	400 x 300	33 - 1203 - Benzin / Preklopiva - Horizontalno	OPRE0053
18.	400 x 300	30 - 1202 - Dizel / Preklopiva - Vertikalno	OPRE0303
19.	400 x 300	33 - 1203 - Benzin / Preklopiva - Vertikalno	OPRE0304

TABLE A.D.R.

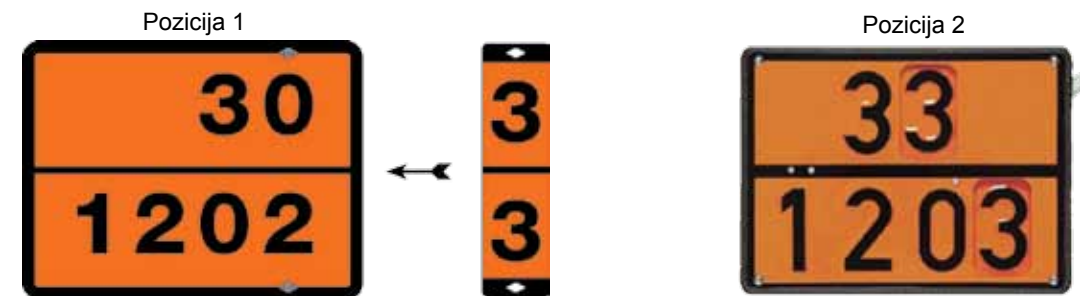

Poz.	Dimenzije (mm)	Opis	RAPIDEX broj
1.	400 x 300	Izmenljiva tabla za dizel i benzin	OPRE0305
2.	400 x 300	Izmenljiva tabla sa ručicom za dizel i benzin	OPRE0054

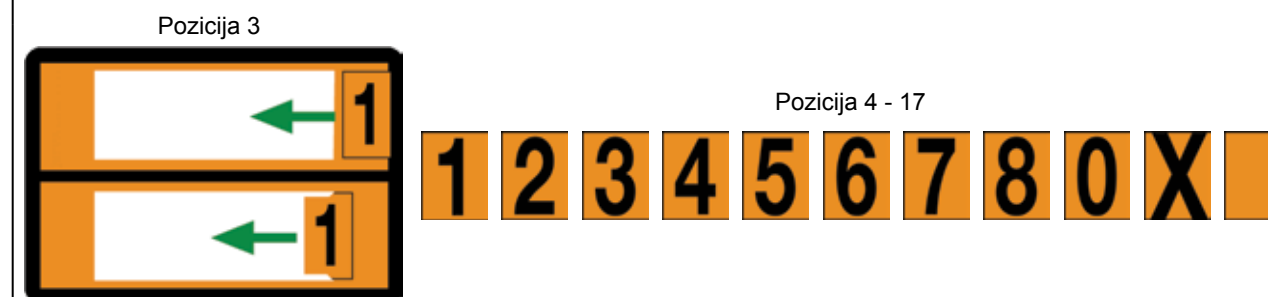

Poz.	Dimenzije (mm)	Opis	RAPIDEX broj
3.	400 x 300	Tabla(nosač) A.D.R. za različite trasporte	OPRE0034
4.	70 x 118	Set od 10 simbola za tablu A.D.R.: 0 - 2 kom.; 1 - 1 kom.; 2 - 2 kom.; 3 - 3 kom.; Prazno polje - 2 kom.	OPRE0050
5.	70 x 118	Set od 12 simbola za tablu A.D.R.: 1 - 1 kom.; 2 - 1 kom.; 3 - 2 kom.; 5 - 1 kom.; 6 - 3 kom.; 7 - 1 kom.; 8 - 1 kom.; Prazno polje - 2 komada	OPRE0051
6.	70 x 118	Set od 33 simbola za tablu A.D.R.: 0 - 3 kom.; 1 - 3 kom.; 2 - 3 kom.; 3 - 4 kom.; 4 - 2 kom.; 5 - 3 kom.; 6 - 5 kom.; 7 - 2 kom.; 8 - 3 kom.; X - 2 kom.; Prazno polje - 3 komada	OPRE0306
7.	70 x 118	Broj 1 za tablu A.D.R.	OPRE0307
8.	70 x 118	Broj 2 za tablu A.D.R.	OPRE0308
9.	70 x 118	Broj 3 za tablu A.D.R.	OPRE0309
10.	70 x 118	Broj 4 za tablu A.D.R.	OPRE0310
11.	70 x 118	Broj 5 za tablu A.D.R.	OPRE0311
12.	70 x 118	Broj 6 za tablu A.D.R.	OPRE0312
13.	70 x 118	Broj 7 za tablu A.D.R.	OPRE0313
14.	70 x 118	Broj 8 za tablu A.D.R.	OPRE0314
15.	70 x 118	Broj 0 za tablu A.D.R.	OPRE0315
16.	70 x 118	Simbol X za tablu A.D.R.	OPRE0316
17.	70 x 118	Prazno polje za tablu A.D.R.	OPRE0317

TABLE ZA OZNAČAVANJE OPASNIH MATERIJIA 300 x 300 mm

	Klasa 1.1, 1.2, 1.3 RAPIDEX broj: OPRE0318		Klasa 1.4 RAPIDEX broj: OPRE0320		Klasa 1.5 RAPIDEX broj: OPRE0319
	Klasa 1.6 RAPIDEX broj: OPRE0321		Klasa 2 RAPIDEX broj: OPRE0322		Klasa 2 RAPIDEX broj: OPRE0323
	Klasa 2 RAPIDEX broj: OPRE0324		Klasa 3 RAPIDEX broj: OPRE0340		Klasa 4.1 RAPIDEX broj: OPRE0325
	Klasa 4.2 RAPIDEX broj: OPRE0326		Klasa 4.3 RAPIDEX broj: OPRE0327		Klasa 5 RAPIDEX broj: OPRE0328
	Klasa 5.1 RAPIDEX broj: OPRE0329		Klasa 5.2 RAPIDEX broj: OPRE0330		Klasa 6.1 RAPIDEX broj: OPRE0331
	Klasa 6.2 RAPIDEX broj: OPRE0332		Klasa 7/A RAPIDEX broj: OPRE0333		Klasa 7/B RAPIDEX broj: OPRE0334
	Klasa 7/C RAPIDEX broj: OPRE0335		Klasa 7 RAPIDEX broj: OPRE0336		Klasa 8 RAPIDEX broj: OPRE0337
	Klasa 9 RAPIDEX broj: OPRE0338		Klasa 9 RAPIDEX broj: OPRE0339		

TABLE ZA OZNAČAVANJE OPASNIH MATERIJIA

KLASA	OPASNE MATERIJIE
1	Eksplozivne materije i predmeti punjeni eksplozivnim materijama
2	Zbijeni gasovi, gasovi pretvoreni u tečnost i gasovi rastvoreni pod pritiskom
3	Zapaljive tečnosti
4.1	Zapaljive čvrste materije
4.2	Materije sklone samopaljenju
4.3	Materije koje u dodiru sa vodom razvijaju zapaljive gasove
5.1	Oksidirajuće materije
5.2	Organski peroksidi
6.1	Otrovi
6.2	Gadne i zarazne materije
7	Radioaktivne materije
8	Korozivne (nagrizajuće) materije
9	Ostale opasne materije.

KUTIJA ZA PROTIVPOŽARNI APARAT



RAPIDEX broj:
OPRE0886

TEHNIČKE KARAKTERISTIKE:



Spoljašnje mere: 277 x 277 x 635 mm

Unutrašnje mere: 140 ÷ 185 mm

Kapacitet: 6 kg







Ostale karakteristike: vatrootporna, vodootporna i otporna na vibracije



PRIBORI A.D.R.

Slika	Opis	RAPIDEX broj
	Torba A.D.R. Sadrži: PVC rukavice, sredstvo za ispiranje očiju, zaštitne naočare, kompletnu masku, filter zaštitne maske i kecelju	OPRE00315
	Torba A.D.R. Sadrži: PVC rukavice, sredstvo za ispiranje očiju, zaštitne naočare, polumasku, filter zaštitne maske i kecelju	OPRE0070

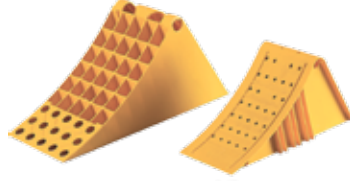

PRIBORI A.D.R.

Slika	Opis	RAPIDEX broj
	Poklopac za kanalizacioni otvor 1000 x 1000 mm	OPRE0341
	Poklopac za kanalizacioni otvor 2000 x 3000 mm	OPRE0342
	Absorbujući granulat	OPRE0343
	Zaštitno odelo	OPRE0344
	Zaštitna šlem	OPRE0345
	Cipele	OPRE0346



PRIBORI A.D.R.		
Slika	Opis	RAPIDEX broj
	Reflektujući prsluk	OPRE0147
	Trougao upozorenja	OPRE0930
	Čunj	OPRE0347
	Čunj - reflektujući	OPRE0348
	Upozoravajuća lampa	OPRE0349
	Baterijska lampa	OPRE0350
	Preklapajuća lopata	OPRE0128

OPREMA		
Slika	Opis	RAPIDEX broj
	GUMENE ZAVESE 450 x 300 mm	OPRE0549
	GUMENE ZAVESE 650 x 400 mm	OPRE0548
	GUMENE ZAVESE 2400 x 400 mm	OPRE0541
	KLOCNA TOČKA metalna 160 mm	OPRE0359
	KLOCNA TOČKA metalna 200 mm	OPRE0183
	KLOCNA TOČKA plastična 160 mm	OSTA3577
	KLOCNA TOČKA plastična 200 mm	OPRE0912
	NOSAČ ZA KLOCNU 160 mm	OPRE0941
	NOSAČ ZA KLOCNU 200 mm	OPRE0947
	KUTIJA ZA ALAT 600 x 450 x 470 mm 700 x 450 x 650 mm 800 x 450 x 470 mm 1000 x 500 x 470 mm	OPRE0813 OPRE0950 OPRE0949 OPRE0948
	DIZALICA 8 t 12 t 16 t 20 t 30 t	OPRE0360 OPRE0361 OPRE0362 OPRE0208 OPRE0364
	RUDA ZA VUČU	OPRE0194
	PRIBOR ZA ČIŠĆENJE KABINE VOZAČA	OPRE0029

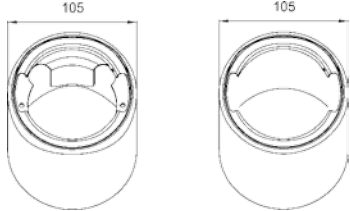
ZAŠTITA REZERVOARA OD KRAĐE GORIVA - KOCKON 105

RAPIDEX broj:	OPRE0814	RAPIDEX broj:	OPRE0803
			

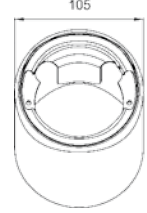



ZAŠTITA REZERVOARA OD KRAĐE GORIVA - KOCKON 105 I ČEP

RAPIDEX broj:	OPRE0804	RAPIDEX broj:	OPRE0830
			

ČEP ZIPPER 105

RAPIDEX broj:	OPRE0808
	

ZAŠTITA REZERVOARA OD KRAĐE GORIVA - TERMOKING

RAPIDEX broj:	OPRE0819	RAPIDEX broj:	OPRE0820
			



PRIBOR ZA OSIGURAVANJE TERETA

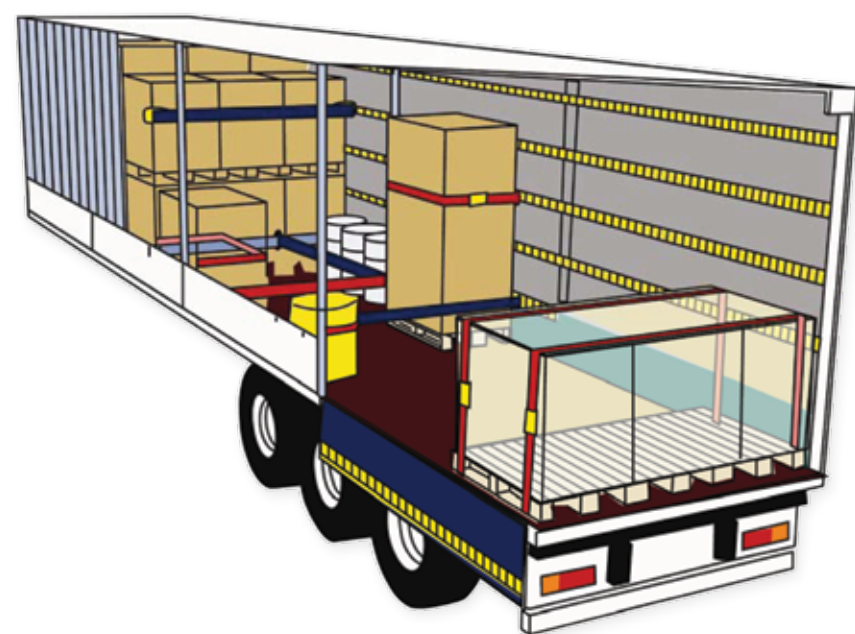
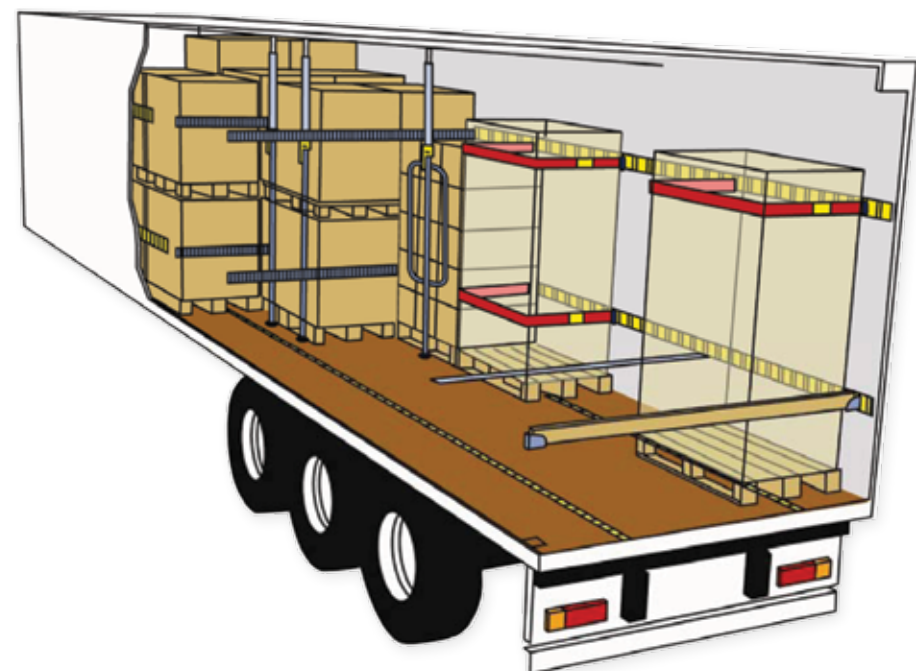

PRIBOR ZA OSIGURAVANJE TERETA



Poz.	Naziv	Dimenzije	Nosivost (daN)		RAPIDEX broj
1.	Traka za vezivanje tereta KPL	8 m x 50 mm	2500	5000	OPRE0185
2.	Traka za vezivanje tereta KPL	10 m x 50 mm	2500	5000	OPRE0184
3.	Traka za vezivanje tereta KPL	12 m x 50 mm	2500	5000	OPRE0170
4.	Traka za vezivanje tereta KPL Duga ručka	8 m x 50 mm	2500	5000	OPRE0780
5.	Traka za vezivanje tereta KPL Duga ručka	10 m x 50 mm	2500	5000	OPRE0779
6.	Traka za vezivanje tereta	10 m x 50 mm	2500	5000	OPRE001
7.	Štitnik robe	180 x 140 x 150 mm			OPRE0939



Poz.	Naziv	Dimenzije		RAPIDEX broj
1.	Letva ADR - aluminijum	21 - 36 mm	2400 - 2700 mm	OPRE0132



Poz.	Naziv	Dimenzije		RAPIDEX broj
1.	Držač - aluminijum	Ø42 mm	2100 - 2470 mm	OPRE0353
2.	Držač - aluminijum	Ø38 mm	2260 - 2630 mm	OPRE0133
3.	Držač - aluminijum	Ø42 mm	2350 - 2720 mm	OPRE0134
4.	Držač - aluminijum	Ø42 mm	2575 - 2965 mm	OPRE0700

8.4 LANCI ZA SNEG

JEDNODELNI LANCI ZA SNEG

Poz.	Primena	RAPIDEX broj
1.	295/60 R22,5	OPRE0954
2.	315/60 R22,5	OPRE0953
3.	315/70 R22,5	OPRE0952
4.	315/80 R22,5	OSTA0198

TRODELNI LANCI ZA SNEG

Poz.	Primena				RAPIDEX broj
1.	205/75 R17,5 215/75 R17,5 225/75 R17,5 235/75 R17,5 7,00 R17,5 8,00 R17,5 8,50 R17,5 9,00 R17,5	7,00 R19,5 8,00 R19,5	6,50 R20		OPRE0357
2.	8,25 R17	245/70 R19,5 265/70 R19,5 275/70 R19,5 285/70 R19,5 9,00 R19,5 9,50 R19,5	7,50 R20 8,25 R20	225/70 R22,5 8,00 R22,5 9,00 R22,5	OPRE0112
3.	305/70 R19,5	9,00 R20	275/70 R22,5 295/70 R22,5 295/60 R22,5 305/60 R22,5 10,00 R22,5	9,50 R24	OPRE0358
4.	10,00 R20 11,00 R20 12,00 R20 12,5 R20 12/80 R20 13/80 R20	11,00 R22	11,00 R22,50 12,00 R22,5 13,00 R22,5 12/80 R22,5 275/80 R22,5 295/80 R22,5 315/80 R22,5 315/75 R22,5 305/70 R22,5 315/70 R22,5 315/60 R22,5	11.2 R24 305/75 R24,5 315/75 R24,5	OPRE0108

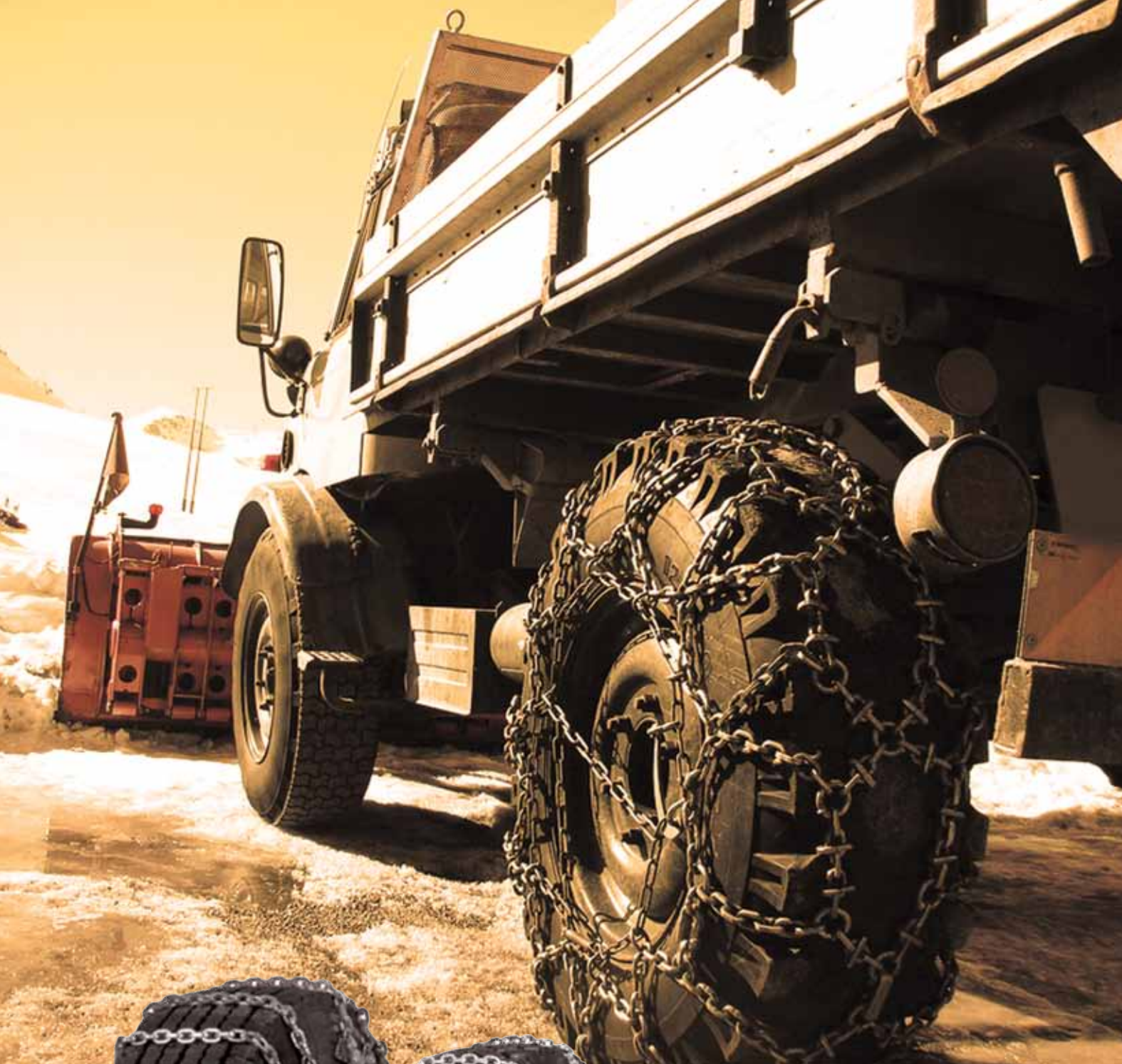

VUČNA KUKA AUTOMATSKA TIP 5055 A, DIN 74053, ISO 1102. D-50

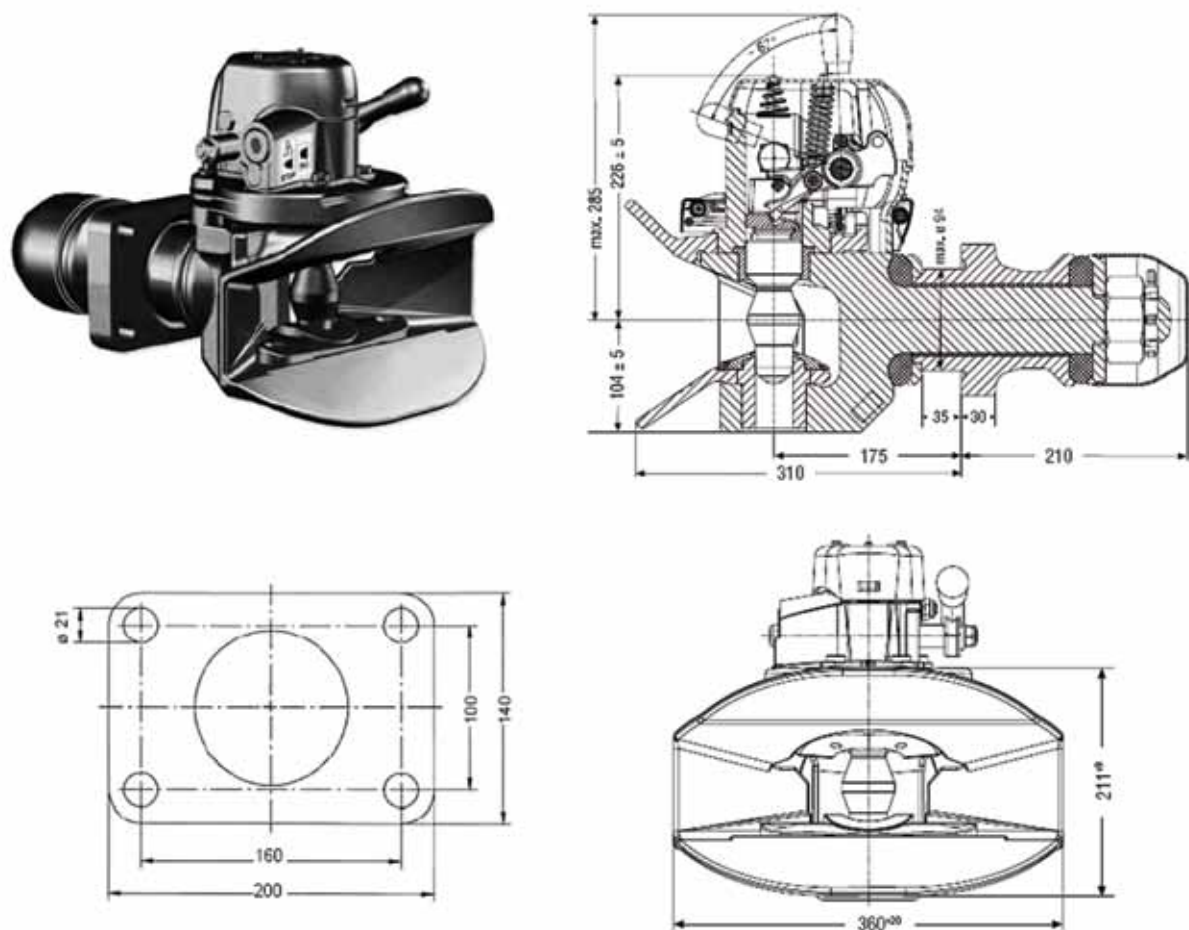

Tehničke karakteristike	Naziv	KBP	RAPIDEX broj
D = 200 kN DC = 135 kN V = 75/63 kN m = 50 kg	VUČNA KUKA	14 996 305	KARO0586
	GORNJA ČAURA	14 995 463	OPRE0237
	DONJA ČAURA	14 991 239	OPRE0236
	STOŽER	14 991 279	OPRE0238
	ZAŠTITNI LIM	14 991 255	OPRE0245

VUČNA KUKA AUTOMATSKA TIP 2045 G/145 G/150, DIN 74054, ISO 8755

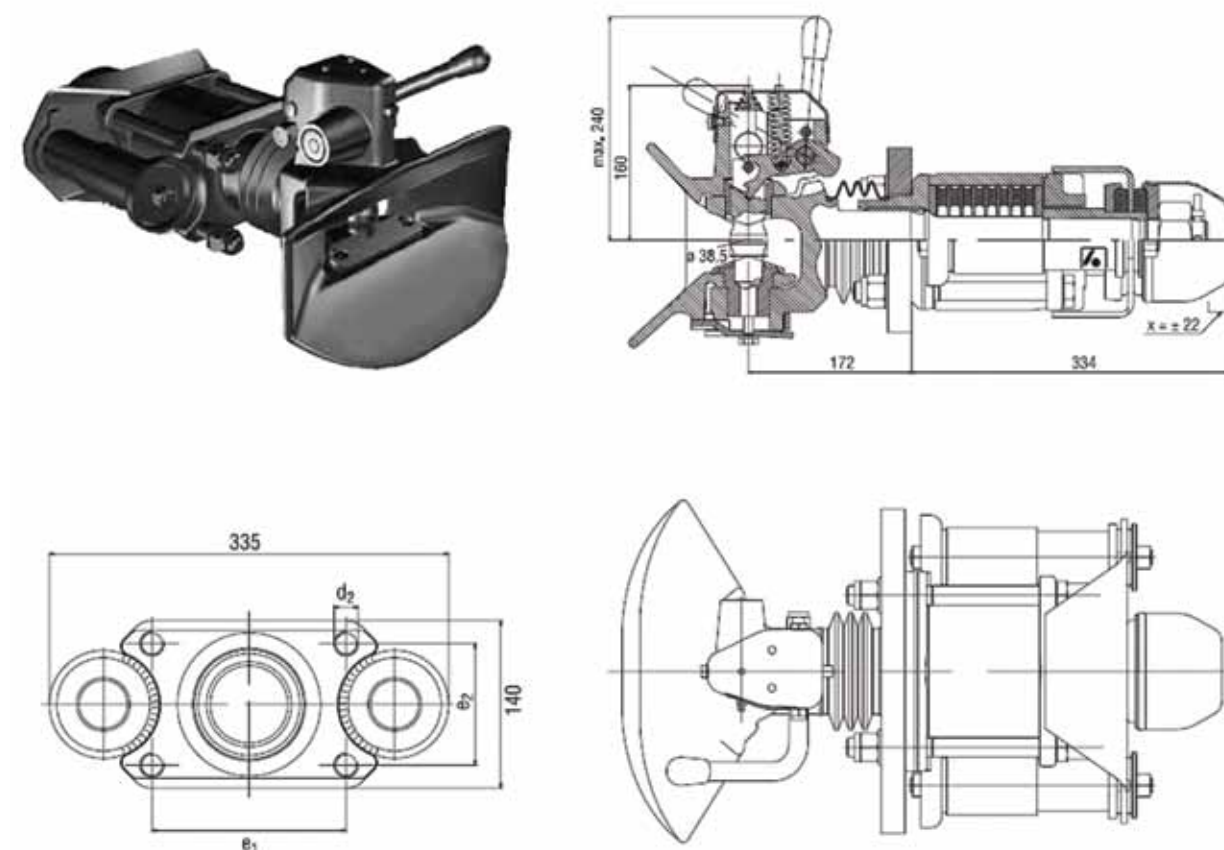

Tehničke karakteristike	Naziv	KBP	RAPIDEX broj
D = 100 kN G/145 D = 136 kN G/136 E1-G/145-140, G/150-160 E2-G/145-80, G/150-100	VUČNA KUKA	G/145 14 995 435	KARO0587
		G/150 14 995 447	KARO0651
	GORNJA ČAURA	6 997 899	OPRE0241
	DONJA ČAURA	6 997 880	OPRE0243
	STOŽER	12 991 452	OPRE0239

VUČNA KUKA AUTOMATSKA TIP 92/CX, DIN 74053, ISO 1102 D 50

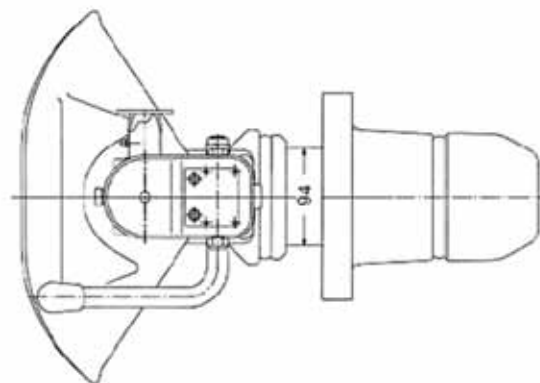
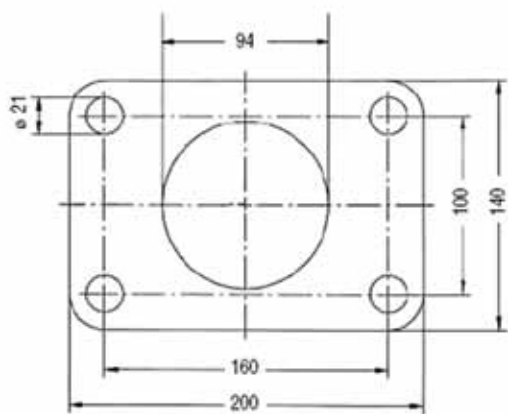
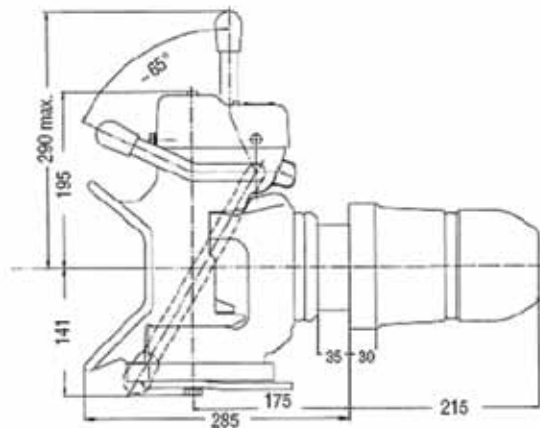

Tehničke karakteristike	Naziv	KBP	RAPIDEX broj
D = 190 kN DC = 130 kN V = 75 kN m = 50 kg	VUČNA KUKA	13 997 020	KARO0588
	GORNJA ČAURA	7 998 210	OPRE0242
	DONJA ČAURA	7 998 252	OPRE0244
	STOŽER	13 991 460	OPRE0240

AIR TOP 2000 ST



RAPIDEX broj:
HLAĐ0182



Napon (V)	Snaga (KW)	Potrošnja goriva (l/h)	Potrošnja energije (W)	Dimenzije (mm)	Težina uređaja (kg)
24	0,9 - 2,0	0,12 - 0,24	14 - 29	311 x 120 x 121	2,6

REZERVNI DELOVI - AIR TOP 2000 / 2000S / 2000ST

Poz.	Slika	Naziv / Opis	KBP	RAPIDEX broj
1.		GORIONIK AT 2000	65786A	HLAĐ0146
2.		MOTOR GREJČA AT 2000 / S	70678A	KABI0004
3.		SVEĆICA-GREJAČ AT 2000 / S	82307A	KABI0003
4.		SENZOR PLAMENA AT 2000	82306C	HLAĐ0178
5.		ZAPTIVKA AT 2000 / S / ST	1303517A	HLAĐ0751

REZERVNI DELOVI - AIR TOP 2000 / 2000S / 2000ST				
Poz.	Slika	Naziv / Opis	KBP	RAPIDEX broj
6.		PUMPA GORIVA	65210A	ELEK0505
7.		ELEKTRONIKA AT 2000	87453B	KABI1458
8.		GORIONIK AT 2000 ST	1302799	HLAĐ0656
9.		MOTOR GREJAČA AT 2000 ST N.TIP	1302788	HLAĐ0752
10.		MOTOR GREJAČA AT 2000 ST S.TIP	1303848A	ELEK1716
11.		SVEĆICA-GREJAČ AT 2000 ST	9005087A	HLAĐ0753

AIR TOP 3500 ST					
					RAPIDEX broj: HLAĐ0861
Napon (V)	Snaga (KW)	Potrošnja goriva (l/h)	Potrošnja energije (W)	Dimenzije (mm)	Težina uređaja (kg)
24	1,5 - 3,5	0,18 - 0,42	15 - 33	428 x 148 x 162	5,9

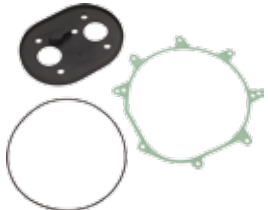
REZERVNI DELOVI - AIR TOP 3500 ST				
Poz.	Slika	Naziv / Opis	KBP	RAPIDEX broj
1.		GORIONIK AT 3500 ST	9004220A	KABI1451
2.		MOTOR GREJAČA AT 3500 ST	9005916A	HLAĐ0754
3.		SVEĆICA-GREJAČ AT 3500 ST	9004215	HLAĐ0755
4.		PUMPA GORIVA	65210A	ELEK0505
5.		GARNITURA ZAPTIVKI	1322643A	HLAĐ1040

AIRTRONIC D2

Poz.	KBP	Opis	RAPIDEX broj		
1.	252675050000	12 V KPL sa setom za montažu	KABI1698		
2.	252676050000	24 V KPL sa setom za montažu	KABI1697		
					
Kapacitet grejanja	W	2200	1800	1200	850
Protok toplog vazduha	kg/h	105	90	60	40
Potrošnja energije	W	34	22	12	8
Potrošnja goriva	l/h	0,28	0,23	0,15	0,1
Dimenzije uređaja	mm	310 x 115 x 122	-	-	-
Težina uređaja	kg	2,7	-	-	-

REZERVNI DELOVI - AIRTRONIC D2

Poz.	Slika	Naziv / Opis	KBP	RAPIDEX broj
1.		GORIONIK	252069100100	KABI1459
2.		ZAPTIVKA GORIONIKA	252069060001	KABI1465
3.		MOTOR GREJAČA	252070992000	KABI1460

REZERVNI DELOVI - AIRTRONIC D2

Poz.	Slika	Naziv / Opis	KBP	RAPIDEX broj
4.		ZAPTIVKA MOTORA GREJAČA	252069010003	KABI1456
5.		GREJAČ-SVEČICA	252070010300	KABI1464
6.		SITO SVEČICE KPL	252069100102	KABI1452
7.		SITO SVEČICE	252069100102	KABI1467
8.		PUMPA GORIVA	251908450000 1 - 3 kW	KABI1618
			224518010000 1 - 4 kW	KABI1461
9.		SENZOR PREGREVANJA	252069010200	KABI1866

AIRTRONIC D4S



RAPIDEX broj:
HLAĐ0186

Kapacitet grejanja	W	4000	3000	2000	900
Protok toplog vazduha	kg/h	185	140	100	55
Potrošnja energije	W	55	30	16	7
Potrošnja goriva	l/h	0,51	0,38	0,25	0,11
Dimenzije uređaja	mm	376 x 140 x 150	-	-	-
Težina uređaja	kg	4,5	-	-	-

REZERVNI DELOVI - AIRTRONIC D4/D4S

Poz.	Slika	Naziv / Opis	KBP	RAPIDEX broj
1.		GORIONIK	252113100100	KABI1462
2.		ZAPTIVKA GORIONIKA	252113060001	KABI1636
3.		MOTOR GREJAČA D4	252114992000	KABI1450
4.		MOTOR GREJAČA D4S	252145992000	KABI1642

REZERVNI DELOVI - AIRTRONIC D4/D4S

Poz.	Slika	Naziv / Opis	KBP	RAPIDEX broj
5.		ZAPTIVKA MOTORA GREJAČA	252113010003	KABI1463
6.		GREJAČ-SVEĆICA	252070010300	KABI1464
7.		SITO SVEĆICE KPL	252069100102	KABI1452
8.		SITO SVEĆICE	252069100102	KABI1467
9.		PUMPA GORIVA	251908450000 1 - 3 kW	KABI1618
			224518010000 1 - 4 kW	KABI1461
10.		SENZOR PREGREVANJA	252069010200	KABI1866

CREVA I CEVI GREJANJA				
Poz.	Slika	Opis	KBP	RAPIDEX broj
1.		Ø60 mm	1311898B	HLAĐ1063
		Ø75 mm	102114340000	HLAĐ1065
		Ø90 mm	1311902B	HLAĐ1064
2.		Ø24 mm 1m	95125	OSTA4466
		Ø24 mm 2m	95282	OSTA4613
		Ø30 mm 1m	95130	OSTA4614



Komercijalna Vozila

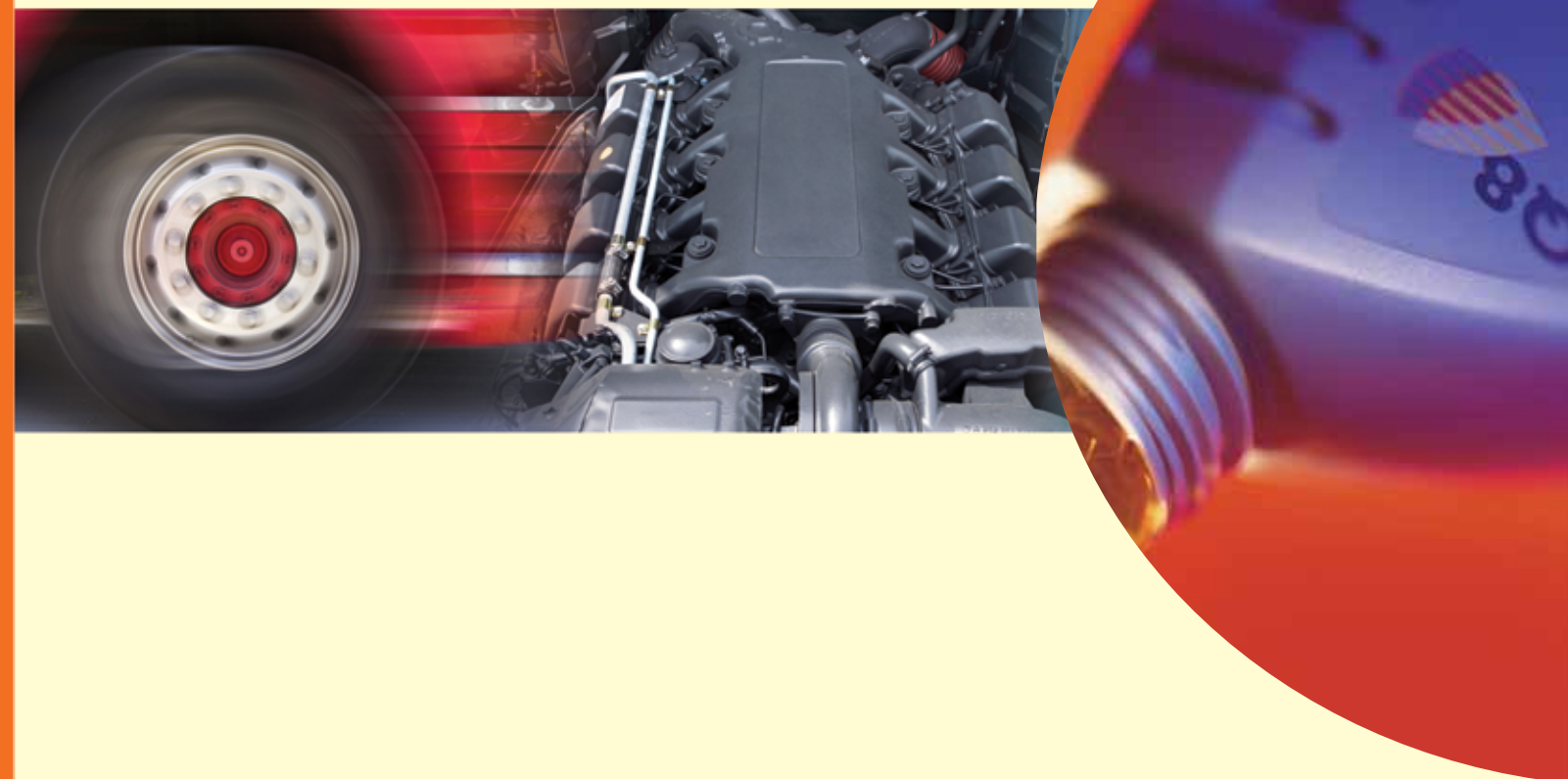

Uvod

Zaštita vašeg motora i ušteda goriva je uvek bila važna uloga Q8 motornih ulja. Zahvaljujući inovacijama, emisija od 25 kamiona danas je jednaka 1 kamionu od pre 30 godina. Da bi se produžio vek ovih motora i vek sistema za prečišćavanje izduvnih gasova, razvili smo novu liniju Q8 Oils maziva za teške dizel motore.

Trendovi

U skladu sa strogim propisima EU o emisiji gasova, svaki moderno dizajnirani kamion sadrži komponente kao što su katalizator, EGR i filtere protiv čađi. Kompanija Q8 Oils razvila je liniju maziva koja ovim komponentama dugoročno obezbeđuje da budu čisti. Time se ujedno smanjuju troškovi održavanja kao i veliki troškovi zamene zagađenih delova; na primer, naknadna ugradnja SCR sistema u proseku košta 7.000,00 EUR.

Naša tehnologija koja je ugrađena u proizvodima Q8 T 904, Q8 T 905, Q8 T 910 i Q8 T 760 obezbeđuje smanjenje vaših troškova održavanja.

Maziva koja obezbeđuju smanjenu potrošnju goriva postala su još privlačnija zato što u najnovijim EURO VI motorima za sve vrste kamiona odobreno je korišćenje ulja sa niskim nivoom gustine, što ujedno predstavlja i za vas priliku da sačuvate novac i garanciju. Maziva koja preporučujemo za smanjenu potrošnju goriva su sledeća: Q8 T 910 5W-30, Q8 T 904 FE 10W-30, Q8 T 760 10W-30 and Q8 SuperTruck FE 5W-30.



Motorna ulja za transportna vozila

Za dugi servisni interval potrebna su ulja visokog kvaliteta, kao što su Q8 T 904 FE ili Q8 T 910.

Rešenje koje pruža kompanija Q8 Oils

U niže navedenoj tabeli prikazani su proizvodi Q8 motorna ulja koja se preporučuju prema vrsti kamiona. SAPS kateorija (Sulphated Ash Phosphorous Sulphur) namenjena za sisteme pročišćavanja izduvnih gasova je specificirana od strane proizvođača kamiona. Izborom Q8 maziva, možete da preferirate između uštede ulja ili periode zamene ulja.

			Ekonomična potrošnja	Osobine pri paljenju hladnog motor	Period zamene ulja						
					DAF	MAN	Mercedes	Volvo	Renault	Iveco	Scania
NISKA VREDNOST PEPELA	Q8 T 904	10W-40	★★	★★	Long Drain	Long Drain	Long Drain	Medium Drain	Medium Drain	Long Drain (*)	-
	Q8 T 905	10W-40	★★	★★★	Long Drain	Long Drain	Long Drain	Medium Drain	Medium Drain	Long Drain (*)	Medium Drain (**)
	Q8 T 904 FE	10W-30	★★★	★★★	Long Drain	Long Drain	Long Drain	Medium Drain	Medium Drain	Long Drain (*)	-
	Q8 T 910	5W-30	★★★★	★★★★	Long Drain	Long Drain	Long Drain	Medium Drain	Medium Drain	Long Drain (*)	-
SREDNJA VREDNOST PEPELA	Q8 T 760	15W-40	*	★★	Medium Drain	Medium Drain	Medium Drain	Long Drain	Long Drain	-	Short Drain (***)
	Q8 T 760	10W-30	★★★	★★★	Medium Drain	Medium Drain	Medium Drain	Long Drain	Long Drain	-	Short Drain (***)
VISOKA VREDNOST PEPELA	Q8 T 860 S	10W-40	★★	★★★	Long Drain	Long Drain	Long Drain	Long Drain	Long Drain	Long Drain	Long Drain (***)
	Q8 Super Truck FE	5W-30	★★★★	★★★★	Long Drain	Long Drain	Long Drain	Long Drain	Long Drain	Long Drain	Long Drain

(*) od Iveco generacije EURO VI
 (**) EURO VI Scania motori
 (***) Scania motori sa DPF filterom

NISKA VREDNOST PEPELA	Q8 T 910	5W-30	FUEL saver	Dizajnirano za uštedu goriva, mazivo niskog viskoziteta sa odličnim osobinama pri paljenju hladnih motora za skoro sve vrste Euro IV, V i VI dizel motora. Ovo sintetičko ulje sa odličnim performansama i SAPS tehnologijom niske vrednosti razvijeno je specijalno za komercijalna vozila sa dizel filterom za čišćenje čestica (DPF).
	Specifikacije:	ACEA E6/E7; API CI-4		
	Odobrenja:	MAN 3477; MB 228.51; VOLVO VDS-3; RENAULT RLD-2; MACK EO-N		
Q8 Oils preporuke:		DEUTZ DQC IV-10 LA; MACK EO-M PLUS; MTU TYP-3.1; RENAULT VI RGD/RXD; VOLVO CNG		
NISKA VREDNOST PEPELA	Q8 T 905	10W-40		Sintetičko motorno ulje visokih performansi za teške uslove rada sa niskom vrednošću SAPS-a. Dizajniran je za podmazivanje velikog broja Euro IV, V i VI dizel motora opremljenih sa filterom za čišćenje čestica (DPF) ili katalizatorom (kao SCR) i radi na dizel gorivu sa malo sumpora i pod teškim uslovima. Takođe odgovara i Euro III motorima. Q8 T 905 ima odlična svojstva pri paljenju hladnih motora.
	Specifikacije:	ACEA E6/E7/E9; API CI-4;		
	Odobrenja:	DEUTZ DQC III-10 LA; MACK EO-N; MAN 3477; MB 228.51; MTU TYP-3; RENAULT VI RLD-2; SCANIA Low Ash; VOLVO VDS-3		
Q8 Oils preporuke:		CUMMINS CES 20076/77; DAF; MACK EO-M PLUS; MB 226.9; MTU TYP 3.1; RENAULT VI RGD, RXD; VOLVO CNG; MAN 3271-1; CATERPILLAR ECF-1a		
NISKA VREDNOST PEPELA	Q8 T 904 FE	10W-30	FUEL saver	Dizajniran za štednju goriva, mazivo niskog viskoziteta za skoro sve Euro IV, V i VI dizel motore. Sintetičko motorno ulje visokih performansi za teške uslove rada sa niskom vrednošću SAPS-a.
	Specifikacije:	ACEA E6,E7; API CI-4		
	Odobrenja:	MAN M3477; MB 228.51; VOLVO VDS-3; RENAULT VI RLD-2; MACK EO-N		
Q8 Oils preporuke:		DAF; CUMMINS CES 20076/77; DEUTZ DQC III-10 LA		
NISKA VREDNOST PEPELA	Q8 T 904	10W-40		Sintetičko motorno ulje visokih performansi za teške uslove rada sa niskom vrednošću SAPS-a dizajniran je za podmazivanje skoro svih Euro IV, V i VI dizel motora.
	Specifikacije:	ACEA E6 /E7; API CI-4		
	Odobrenja:	MAN M3477; MB 228.51; MTU Type 3.1; RENAULT VI RLD-2; VOLVO VDS-3; MACK EO-N; DEUTZ DQC III-10 LA		
Q8 Oils preporuke:		DAF; CUMMINS CES 20076/77		
SREDNJA VREDNOST PEPELA	Q8 T 760	15W-40 10W-30	FUEL saver	SHPD (Super High Performance Diesel) dizel motorno ulje sa niskom vrednošću sulfatnog pepela i ograničenom vrednošću fosfora i sumpora, namenjeno za motore koji su u skladu sa Euro V standardom i Američkim EPA 2007 zahtevima za izduvne gasove. Pogodno je za duge intervale zamene ulja i za vozila opremljena sa filterima za čišćenje čestica i katalizatorima (npr. SCR). Q8 T 760 SAE 15W-40 takođe može da se koristi i za Euro II i III dizel motore. Q8 T 760 SAE 10W-30 je ulje koje štedi gorivo, niskog viskoziteta i nije pogodan za starije motore.
	Specifikacije:	ACEA E9; API CJ-4/API SN; CATERPILLAR ECF-1a/ECF-2/ECF-3		
	Odobrenja:	MACK EO-O PREMIUM PLUS; MAN 3575; MB228.31; RENAULT VI RLD-3; VOLVO VDS-4		
Q8 Oils preporuke:		CUMMINS CES 20081; DDC 93K218; DEUTZ DQC III-10; MAN 3275; MTU TYPE 2.1		
VISOKA VREDNOST PEPELA	Q8 T 860 S	10W-40		Dizel motorno ulje sa izuzetno visokim performansama koje se sastoji od sintetičkih baznih ulja. Razvijeno je motore kompanije Scania koja dozvoljava zamenu ulja na 120.000 km. Na tržištu je dostupno od marta 2013.
	Specifikacije:	ACEA E4/E7; API CF		
	Odobrenja:	SCANIA LDF-3		
Q8 Oils preporuke:		VOLVO VDS-3; MB 228.5; MAN 3277; RENAULT RLD-2		
VISOKA VREDNOST PEPELA	Q8 SuperTruck FE	5W-30	FUEL saver	Dizajnirano za uštedu goriva, mazivo niskog viskoziteta sa odličnim osobinama pri paljenju hladnih motora za skoro sve vrste Euro III i neke vrste Euro IV i V i dizel motora. Ovo je UHPD (Ultra High Performance Diesel) sintetičko dizel motorno ulje sa izuzetno visokim performansama koje omogućava produženi interval zamene ulja.
	Specifikacije:	ACEA E4/E7		
	Odobrenja:	MAN 3277; MB 228.5;		
Q8 Oils preporuke:		IVECO; CUMMINS CES 20071/72/76/77; MACK EO-M PLUS; MB 235.28; MTU TYPE-3; SCANIA LDF; VOLVO VDS-3		

VISOKA VREDNOST PEPELA	Q8 T 860	10W-40	UHPD dizel motorno ulje sa izuzetno visokim performansama na sintetičkoj bazi namenjeno je za skoro sve Euro III i pojedine Euro IV i V dizel motore. ACEA E4 specifikacija garantuje visok nivo čišćenja čađi u motoru.
	Specifikacije:		ACEA E4/E7; API CI-4
	Odobrenja:		CUMMINS CES 20077/78; DEUTZ DQC III-05; MACK EO-M PLUS; MAN 3277; MB 228.5; MTU TYPE-3; SCANIA LDF-2; TEDOM 258-3; VOLVO VDS-3
	Q8 Oils preporuke:		DAF; JASO DH-1; RENAULT VI RXD/RLD-2; VOITH RETARDER KLASSE A
VISOKA VREDNOST PEPELA	Q8 T 800	10W-40	Polu-sintetičko dizel motorno ulje visokih performansi namenjeno je za Euro III i Euro IV motore sa niskom emisijom izduvnih gasova, koje omogućava i smanjenje potrošnje goriva. Takođe je pogodno za dizel motore putničkih automobila i manje motore sa direktnim ubrizgavanjem.
	Specifikacije:		ACEA E7/B4/A3; API CI-4/SL
	Odobrenja:		MACK EO-N; MAN 3275; RENAULT VI RLD-2; TEDOM 258-3; VOLVO VDS-3, DEUTZ DQC III -10; MTU TYP-2
	Q8 Oils preporuke:		CUMMINS CES 20071/72/76/77/78; MACK EO-M PLUS; MB 228.3; MB 229.1; GLOBAL DHD-1; CATERPILLAR ECF-1/ECF-2
VISOKA VREDNOST PEPELA	Q8 T 750	15W-40	Q8 T 750 može da se koristi za sve četvorotaktne dizel motore sa gorivom koje ima malu vrednost sumora (<0.05 %) i za motore kamoiona, kao i za motore poljoprivrednih i industrijskih radilica koje rade pod teškim uslovima. Takođe može da se koristi kod benzinskih i dizel motora putničkih automobila.
	Specifikacije:		ACEA E7/B4/A3; API CI-4/SL;
	Odobrenja:		DEUTZ III-10; MACK EO-N PLUS; MAN 3275; VOLVO VDS-3; MB 228.3; MTU TYPE-2; RENAULT VI RLD, RLD-2; ZF TE-ML 04C/07C; CUMMINS 20071/72/76/77
	Q8 Oils preporuke:		MB 229.1; GLOBAL DHD-1; CATERPILLAR ECF-1/ECF-2



Ulja za menjače i osovine kod komercijalnih vozila

Kod savremenih menjača i osovina, od suštinskog značaja su dobra zaštita od trenja i termička stabilnost, da bi se postigao što duži servisni interval. Ulja za menjače imaju i veliki uticaj na potrošnju goriva. Kao na primer Q8 T 60Ntech u menjaču i Q8 T 66 u zadnjoj osovini.

	GL-4	GL-5	mil-prf 2104e	Synth. Base Oil Components	Long Drain	Fuel Economy	Drive Line = Gear Box + Rear Axle	Intarder Suited	DAF	Iveco	MAN	Mercedes	Renault	Scania	Volvo
MENJAC	Q8 Gear Oil XG	✓	✓	-	*	*	✓	-	-	-	✓	-	-	✓	-
	Q8 T60Ntech	-	-	-	**	**	-	✓	✓	✓	✓	-	✓	-	-
	Q8 Supergear S	GL-3	-	-	***	**	**	-	-	-	-	-	-	-	✓
	Q8 T 36	✓	-	-	***	***	*	-	-	-	-	✓	-	-	-
ZADNJA OSOVINA	Q8 Axle Oil XG	✓	✓	✓	-	*	✓	-	✓	✓	-	-	-	✓	-
	Q8 Trans XGS	✓	✓	✓	***	***	**	✓	✓	✓	✓	✓	-	-	-
	Q8 T 65	-	✓	-	***	***	**	-	-	-	-	-	-	-	✓
	Q8 Unigear GL-5	-	✓	-	**	**	**	-	-	-	-	-	-	-	✓
	Q8 T 66	✓	✓	✓	***	***	***	-	✓	✓	✓	✓	-	✓	✓

MENJAC	Q8 Gear Oil XG	80W-90	Q8 Gear Oil XG je automotivno univerzalno menjačko ulje za sinhronizovane i nesinhronizovane manuelne menjače, osovine i sve komponente koje prenose snagu (od motora do zadnje osovine) i koje zahtevaju API GL-4/GL-5 nivo performansi. Odobreno je od strane kompanije Scania za servisni interval do 180.000 km.
	Specifikacije: Odobrenja:		API GL-4; API GL-5 SCANIA STO 1:0; SAE J 2360 (PRI GL 0208); MAN 341 E2/Z2, 342 M2; ZF TE-ML 02B/05A/12E
MENJAC	Q8 T 60 Ntech	75W-80	Q8 T 60 Ntech je ulje na sintetičkoj bazi za manuelne menjače sa visokim performansama koji zahtevaju specijalne osobine tečnosti na niskim i visokim temperaturama, što rezultuje da se lakše menjaju brzine.
	Odobrenja: Q8 Oils preporuke:		ZF TE ML 02L MAN 341 Z3/E3/Z4; VOLVO 97305; ZF TE-ML 01L
MENJAC	Q8 SuperGear S	75W-80	Q8 SuperGear S je sintetičko ulje sa najnovijom tehnologijom aditiva za manuelne menjače. Može se koristiti kao višenamensko ulje za manuelne menjače kod kamiona, autobusa i putničkih automobila.
	Specifikacije: Q8 Oils preporuke:		API GL-3; VOLVO 97305 JOHN DEERE JDM J11C; VOLVO 97307
MENJAC	Q8 SuperGear V	75W-80	Q8 SuperGear V je sintetičko ulje razvijeno za Volvo manuelne menjače. Može se koristiti kao ulje za manuelne menjače u kamionima i autobusima.
	Specifikacije: Odobrenja: Q8 Oils preporuke:		API GL-4 VOLVO 97307 MAN 341 ZE-VR (former MAN 341 SL); VOITH RETARDER OIL CLASS C; EATON S SERIES TRANSMISSIONS
MENJAC	Q8 T 36	75W-90	Q8 T 36 je potpuno sintetičko ulje za "switch gear" menjače sa najvišim performansama koji zahtevaju posebna svojstva tečnosti na visokim i niskim temperaturama i time poboljšavaju prenose. Proizvod je razvijen specijalno za komercijalna vozila marke Mercedes.
	Specifikacije: Odobrenja:		API GL-4 MAN 342 TYP MB; MB 235.11
ZADNJA OSOVINA	Q8 Axle Oil XG	80W-140	Automotivno ulje koje je namenjeno za osovine i diferencijale. Odobreno je od strane kompanije Scania za servisni interval do 180.000 km.
	Specifikacije: Odobrenja: Q8 Oils preporuke:		API GL-4/GL-5; MIL-PRF-2105 E SCANIA STO 1:0; ZF TE-ML 05A/12E/16D/21A ZF TE-ML 02B
ZADNJA OSOVINA	Q8 Trans XGS	75W-90	Sintetičko automotivno ulje za zadnje osovine, diferencijale i pojedine manuelne menjače koji rade pod teškim uslovima i koji zahtevaju posebne osobine tečnosti pri niskim temperaturama da bi se dobila niža potrošnja goriva i lakša promena brzina.
	Specifikacije: Odobrenja: Q8 Oils preporuke:		API GL-4/GL-5; MIL-PRF-2105-E MAN 341 E3/Z2, 342 M3; SCANIA STO 1:0; ZF TE-ML 02B/5A/12B MAN 342 S1
ZADNJA OSOVINA	Q8 T 65	75W-90	Sintetičko ulje za menjače koje pruža kombinaciju dobrih osobina tečnosti na niskim i visokim temperaturama. Time se smanjuje trenje i samim tim smanjuje se i buka prenosa i potrošnja goriva.
	Specifikacije: Odobrenja: Q8 Oils preporuke:		API GL-5 VOLVO 97312; ZF TE-ML 17B/19B ZF TE-ML 05A
ZADNJA OSOVINA	Q8 Unigear GL-5	75W-90	Automotivno ulje na sintetičkoj bazi namenjeno je za manuelne menjačime i osovine u putničkim i komercijalnim vozilima.
	Specifikacije: Q8 Oils preporuke:		API GL-5; MIL-L-2105D ZF TE-ML 05A
ZADNJA OSOVINA	Q8 T 66	75W-110	Razvijen u cilju postizanja značajne uštede goriva za osovine u kamionima koji rade pod velikim opterećenjem. Relativno novi viskozitet SAE 110 se koristi radi postizanja optimalnog podmazivanja. Ovo sintetičko ulje je za podmazivanje visoko opterećenih komponenta, kao što su zadnje osovine, diferencijali i pojedini menjači. Potvrđeno je da Q8 T 66 smanjuje potrošnju goriva do 4,7 %.
	Specifikacije: Q8 Oils preporuke:		API GL-4/GL-5; API MT-1; MIL-PRF-2105E; SAE J 2360 ZF TE-ML-05B/12B; MACK GO-J; MB 235.8; MAN 341 S1; SCANIA STO 1:0





Ulja za automatske menjače u komercijalnim vozilima

Q8 Auto 14

Ulje za automatske menjače koje takođe odgovara za servo volane i kao hidraulično ulje.

Q8 Oils preporuke:

MB 236.7; VME; ZF TE-ML 14A; VOITH 55.6335.3X

Q8 Auto 15 ED

Q8 Auto 15 ED je ulje na sintetičkoj bazi za automatske menjače koje takođe odgovara za servo volane i kao hidraulično ulje.

Q8 Oils preporuke:

VOITH DIWA H55.6336.3X; ZF TE-ML 14B



Hidraulična ulja za komercijalna vozila

Q8 Haydn

10, 15,
22, 32,
46, 68,
100, 150

Univerzalno hidraulično ulje za višenamensku upotrebu sa indeksom viskoziteta vrednosti 100. Bazno ulje ima dobar prirodni otpor starenju (oskidaciji) i ujedno veoma svetlu boju. Ovo se lako filtrira.

Važeći za sledeće primene:

AFNOR 48-603, CATEGORY HM; MAG IAS P-68/P-69/P-70; DENISON HF-0/HF-1/HF-2; DIN 51524 PART 2, CATEGORY HLP; ISO 11158, CATEGORY HM; SS 155434, CATEGORY AM

Q8 Heller

15, 22,
32, 46,
68, 100

Q8 Heller je mineralno hidraulično ulje tipa HVLP sa izuzetno visokim indeksom viskoziteta, vrednosti 150. Q8 Heller je idealno za upotrebu u hidrauličnim sistemima koje rade u uslovima velikih temperaturnih promena. Optimalni viskozitet pri pokretanju u hladnim uslovima obezbeđuje neometani rad hidrauličnih sistema. Koristi se za kopačice i ostale mašine koje rade u spoljnim uslovima. Q8 Heller odgovara zahtevima većine proizvođača džipova.

Važeći za sledeće primene:

AFNOR 48-603, CATEGORY HV; DIN 51524 PART 3, CATEGORY HVLP; ISO 11158, CATEGORY HV



Masti za komercijalna vozila

Q8 Rembrandt EP 2

NLGI 2

Višenamenska litijumska mast unapređena sa aditivima koji poboljšavaju osobine otpornosti pri visokom pritisku i oksidaciji; takođe sadrži i inhibitor rđanja.

Veličina pakovanja:

50kg KEG, 12.5kg, 180kg, 12 x 400g (CART)

Q8 Rembrandt Moly

NLGI 2

Visoko kvalitetna višenamenska litijumska mast koja sadrži molibdenski disulfid koji obezbeđuje dodatnu zaštitu od trenja. Sadrži inhibitor rđanja i additive protiv oksidiranja.

Veličina pakovanja:

50kg KEG, 12.5kg, 180kg, 12 x 400g (CART)

Q8 Rembrandt EP 00 WV

NLGI 00

Litijumska mast za centralne sisteme podmazivanja marke Willy Vogel preporučuje se za upotrebu kada se zahtevaju specifikacije MB 264 i MAN 283. Specijalno za automotivne aplikacije gde je potrebno lako pumpanje pri niskim temperaturama.

Veličina pakovanja:

12.5kg, 50kg KEG, 12.5kg

Q8 Rubens WB Blau

NLGI 2

Višenamenska litijumska kompleksna mast za ležajeve u kamionima i prikolicama gde je potrebno lako pumpanje u centralnim sistemima za podmazivanje a zahteva se NLGI 2 mast.

Veličina pakovanja:

50kg KEG, 12.5kg, 12 x 400g (CART)



Ostali proizvodi

Q8 Brake Fluid DOT 4

Nepetrolejska kočiona tečnost sa osobinom stvaranja niskog parnog pritiska. Pogodna je za korišćenje u hidrauličnim sistemima kočnica i kvačila u svim putničkim automobilima, kamionima, autobusima i prikolicama gde se traže proizvodi visokih performansi. Ovaj proizvod se posebno preporučuje za funkcionisanje pri visokim temperaturama koje se stvaraju od kočionih diskova ili kada postoji dodatno opterećenje na kočionom sistemu.

Q8 Oils preporuke:

FMVSS 116 DOT 3; FMVSS 116 DOT 4; SAE J1703

Veličina pakovanja:

50kg KEG, 12.5kg, 180kg, 12 x 400g (CART)

Q8 Antifreeze Long Life

Univerzalni koncentrat antifrizna visokih performansi koji daje zaštitu tokom cele godine kao rashladna tečnost leti i antifriz zimi. Baziran je na etilen glikolu, hemijski stabilan i ne podleže koroziji.

Q8 Oils preporuke:

BS 6580, 5177; SAE J 1034; ASTM D 3306; FVV Heft R 443; MAN 324 TYPE SNF

Veličina pakovanja:

1L, 5L, 25L, 205L

Q8 Degreasing Fluid HFB

Višenamenski odmašivač koji se ispira vodom.

Veličina pakovanja:

25L, 208L

Q8 Oils

MOTORNO ULJE	Q8 T 905	208 litara	RAPIDEX BROJ - ULJA0171
	Q8 T 905	60 litara	RAPIDEX BROJ - ULJA0129
	Q8 T 905	20 litara	RAPIDEX BROJ - ULJA0130

MOTORNO ULJE	Q8 T 860	208 litara	RAPIDEX BROJ - ULJA0135
	Q8 T 860	60 litara	RAPIDEX BROJ - ULJA0128
	Q8 T 860	20 litara	RAPIDEX BROJ - ULJA0127
	Q8 T 860	5 litara	RAPIDEX BROJ - ULJA0157

MOTORNO ULJE	Q8 T 800	1000 litara	RAPIDEX BROJ - ULJA0185
	Q8 T 800	208 litara	RAPIDEX BROJ - ULJA0158
	Q8 T 800	60 litara	RAPIDEX BROJ - ULJA0193
	Q8 T 800	20 litara	RAPIDEX BROJ - ULJA0159
	Q8 T 800	5 litara	RAPIDEX BROJ - ULJA0160

MOTORNO ULJE	Q8 T 760	208 litara	RAPIDEX BROJ - ULJA0171
	Q8 T 760	20 litara	RAPIDEX BROJ - ULJA0129
	-	-	-

MOTORNO ULJE	Q8 T 750	208 litara	RAPIDEX BROJ - ULJA0136
	Q8 T 750	60 litara	RAPIDEX BROJ - ULJA0146
	Q8 T 750	20 litara	RAPIDEX BROJ - ULJA0145
	Q8 T 750	5 litara	RAPIDEX BROJ - ULJA0194

MOTORNO ULJE	Q8 T 520	208 litara	RAPIDEX BROJ - ULJA0161
	Q8 T 520	20 litara	RAPIDEX BROJ - ULJA0162
	-	-	-

ANTIFRIZ	G12 + KONCENTRAT	208 litara	RAPIDEX BROJ - HLA00648
	G12 + KONCENTRAT	20 litara	RAPIDEX BROJ - HLA00647
	-	-	-

MAST	Q8 REMBRANT EP2	192 kilograma	RAPIDEX BROJ - ULJA0246
	Q8 REMBRANT EP2	18 kilograma	RAPIDEX BROJ - ULJA0203
	Q8 REMBRANT EP2	5 kilograma	RAPIDEX BROJ - ULJA0183
	Q8 REMBRANT EP2	0,4 kilograma	RAPIDEX BROJ - ULJA0167
	Q8 RUBENS 00	18 kilograma	RAPIDEX BROJ - ULJA0184
	Q8 RUBENS WB/b	0,4 kilograma	RAPIDEX BROJ - ULJA0166

ULJE ZA KOČNICE I AUTOMATSKJE MENJAČE	Q8 BRAKE FLUID DOT4	0,25 litara	RAPIDEX BROJ - ULJA0163
	Q8 AUTO 15 ATF	20 litara	RAPIDEX BROJ - ULJA0182
	Q8 AUTO 15 ATF	1 litra	RAPIDEX BROJ - ULJA0165
	Q8 LHM MINERALNO ULJE	1 litra	RAPIDEX BROJ - ULJA0164
	-	-	-

HIDROL	Q8 HAYDN 10	208 litara	RAPIDEX BROJ - ULJA0240
	Q8 HAYDN 32	208 litara	RAPIDEX BROJ - ULJA0218
	Q8 HAYDN 46	208 litara	RAPIDEX BROJ - ULJA0212
	Q8 HAYDN 46	20 litara	RAPIDEX BROJ - ULJA0215
	Q8 HAYDN 68	208 litara	RAPIDEX BROJ - ULJA0213
	Q8 HAYDN 68	20 litara	RAPIDEX BROJ - ULJA0216
	Q8 HELLER 46	208 litara	RAPIDEX BROJ - ULJA0214
	Q8 HELLER 68	208 litara	RAPIDEX BROJ - ULJA0191
	-	-	-

ULJE ZA MENJAČ I DIFERENCJAL	Q8 T 60	75W-80	60 litara	RAPIDEX BROJ - ULJA0238
	Q8 T 60	75W-80	20 litara	RAPIDEX BROJ - ULJA0241
	Q8 T 36	75W-90	208 litara	RAPIDEX BROJ - ULJA0237
	Q8 T 65	75W-90	60 litara	RAPIDEX BROJ - ULJA0180
	Q8 T 65	75W-90	20 litara	RAPIDEX BROJ - ULJA0178
	Q8 T 35	80W	20 litara	RAPIDEX BROJ - ULJA0143
	Q8 T 55	80W-90	208 litara	RAPIDEX BROJ - ULJA0200
	Q8 T 55	80W-90	60 litara	RAPIDEX BROJ - ULJA0199
	Q8 T 55	80W-90	20 litara	RAPIDEX BROJ - ULJA0139
	Q8 T 55	80W-90	1 litra	RAPIDEX BROJ - ULJA0188
	Q8 T 55	85W-140	20 litara	RAPIDEX BROJ - ULJA0181
	-	-	-	-



NOVI SAD

Novosadski put 160
21000 Novi Sad
Srbija

Tel./Fax.

021 651 0521
021 651 0522
021 651 0523
021 651 1228
021 651 2254
060 824 8801

e-mail: office@rapidex.co.rs

BEOGRAD

Milošev kladenac BB

Tel./Fax.

011 406 59 48
011 406 67 82
011 406 67 83
060 824 8804

PARAĆIN

Carice Milice 54

Tel./Fax.

035 8 567 611
035 8 567 671
060 824 8833

office@rapidex.co.rs
www.rapidex.co.rs



ČAČAK

Konjevići bb

Tel.

032 559 0037
060 824 8821

LOZNICA

Bulevar Dositeja Obradovića 70

Tel.

015 877 883
015 877 884
060 824 8810

NOVI PAZAR

Save Kovačevića 300

Tel.

020 315 156
060 824 8824

VRANJE

Ivana Meštrovića 27

Tel.

017 410 088
060 824 8835

SOMBOR

XII Vojvodanske udarne
brigade 130

Tel.

025 461 481
060 824 8850

SUBOTICA

Beogradski put 21

Tel.

024 556 246
060 824 8862

VRBAS

Ivana Milutinovića 11

Tel.

021 700 087
060 824 8806

NIŠ

Bulevar 12. Februar 152

Tel./Fax.

018 585 824
060 824 8874

BIJELJINA RAPIDEX DOO

Pantelinska 1

Tel./Fax.

+387 55 247 687

