

The logo features a red hexagonal shape with a white 'X' inside, positioned behind the text.

RAPIDEX
TRADE

KATALOG

REZERVNIH DELOVA ZA KOMERCIJALNA VOZILA



2010/2011



KATALOG

REZERVNIH DELOVA
ZA KOMERCIJALNA VOZILA



Novi Sad

Novosadski put 160,
tel/fax. 021/6510-521, 6510-522, 6510-523, 064/824-88-00

e-mail: office@rapidex.co.rs
www.rapidex.co.rs

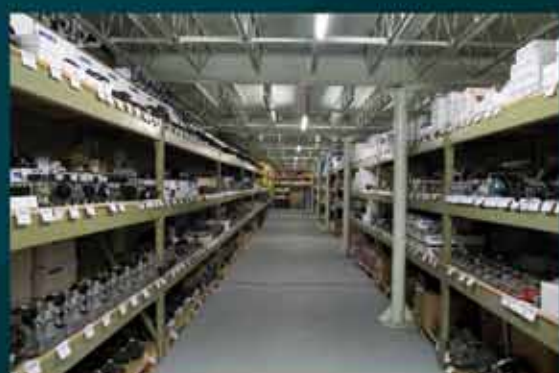

Predstavništva:



Beograd

Veternička 10
tel: 011/3691-365
064/824-88-04



Loznica

Dositeja Obradovića 70
tel. 015/877-883
064/824-88-10



Novi Pazar

Save Kovačevića 300
tel. 020/315-156
064/824-88-24



Čačak

Konjevići BB
tel. 032/459-199
064/824-88-26



Banja Luka

Predstavništvo "RAPIDO"
Nikole Pašića BB
tel. 00387-51/584-544
fax. 00387-51/584-606



ASORTIMAN ROBE RAPIDEX TRADE

Zastupljen je asortiman više od
20.000 pozicija rezervnih delova



SADRŽAJ:

1.0 MOTOR

1.1	Delovi motora	12
1.2	Pumpe vode, ulja i upravljača	27
1.3	Termostati	35
1.4	Španeri motora i prenosni kaiševi	39
1.5	Turbo kompresori	48
1.6	Visko ventilatori	49
1.7	Hladnjaci i interkuleri	51
1.8	Ekspanzione posude i uljni hladnjaci	55
1.9	Izmenjivači toplote i grejači kabine	57
1.10	Kondenzatori i isparivači klime	60
1.11	Creva vode i interkulera	62
1.12	Filteri	75
1.13	Napajanje gorivom	85
1.14	Davači i senzori	94
1.15	Izduvni sistemi	103

2.0 KVAČILO I TRANSMISIJA

2.1	Setovi kvačila i elementi	116
2.2	Centralni ležajevi kardana	124
2.3	Cilindri menjača	126

3.0 KOČIONA PNEUMATIKA I HIDRAULIKA

3.1	Kompresori i delovi	130
3.2	Isušivači vazduha i filteri	133
3.3	Ventili kočionog sistema	135
3.4	Ventili ogibljenja	148
3.5	Cilindri tristop i membranski	154
3.6	Ventili ABS, EBS i ECAS	157
3.7	Elektronika ABS, EBS i ECAS	161
3.8	Senzori	162
3.9	Cilindri kvačila	165
3.10	Pribor kočionog sistema	172
3.11	Setovi ABS, EBS i WABCO dijagnostika	179

4.0 KOMPONENTE KOČIONOG SISTEMA

4.1	Disk kočnica	192
4.2	Kočione pločice	205
4.3	Čeljusti kočnica	214
4.4	Doboši kočnica	219
4.5	Nosači kočionih obloga	228
4.6	Kočione obloge	230
4.7	Anker ploče	243
4.8	Šteleri kočnica	248
4.9	Kočione osovine (S ključevi)	260
4.10	Glavčine točka, ležajevi i semerinzi	266
4.11	Vijci i navrtke	275

5.0 ELEMENTI OGIBLJENJA I UPRAVLJANJA

5.1	Amortizeri	280
5.2	Vazdušni jastuci	302
5.3	Gibnjevi	338
5.4	Delovi stabilizatora	366
5.5	Delovi rukavca	379
5.6	Spone i delovi spona	386
5.7	Uporne spone	404
5.8	V spone	407

6.0 KABINA I DELOVI KABINE

6.1	Delovi kabine	412
6.2	Ogledala i delovi ogledala	510
6.3	Cilindri i pumpe za dizanje kabine	522
6.4	Elementi za oslanjanje kabine	527
6.5	Uređaji za pranje vetrobranskog stakla	541
6.6	Mehanizam vrata	545

7.0 ELEKTRIČNE INSTALACIJE

7.1	Farovi	552
7.2	Pokazivači pravca	573
7.3	Stop i gabaritna svetla	581
7.4	Rotacione lampe	610
7.5	Sijalice, osigurači i tahograf listići	614
7.6	Kablovi električne instalacije	620
7.7	Kombinovani prekidači pod volanom	623
7.8	Akumulatori i pribor	632
7.9	Alternatori	636
7.10	Anlaseri	642

8.0 PRIBORI

8.1	Obeležavajuće table i pribori A.D.R.	648
8.2	Pribor za osiguravanje tereta	664
8.3	Lanci za sneg	666
8.4	Vučne kuke	668
8.5	Grejanje kabine	671

1.0 MOTOR



1.0 MOTOR

1.1	Delovi motora	12
1.2	Pumpe vode, ulja i upravljača	27
1.3	Termostati	35
1.4	Španeri motora i prenosni kaiševi	39
1.5	Turbo kompresori	48
1.6	Visko ventilatori	49
1.7	Hladnjaci i interkuleri	51
1.8	Ekspanzione posude i uljni hladnjaci	55
1.9	Izmenjivači toplote i grejači kabine	57
1.10	Kondenzatori i isparivači klime	60
1.11	Creva vode i interkulera	62
1.12	Filteri	75
1.13	Napajanje gorivom	85
1.14	Davači i senzori	94
1.15	Izduvni sistemi	103

NAZAD NA GLAVNI SADRŽAJ



MAN								
Poz.	Naziv	Federal Mogul broj	Mahle broj	KS broj	Dimenzije (mm)	Tip motora	OE broj	RAPIDEX broj
1.	Klip KPL	87-285900-00	227 37 00	94 487 600	Ø108 EUII	D0826 LF, LOH, LUH	51.02511.7291	MOTO0864
2.	Klip KPL	87-285900-10	227 33 00	93 137 600	Ø108 EUI	D0826 LF, LFL, LUH	51.02511.0069	MOTO0556
3.	Klip KPL	87-285900-40			Ø108 turbo	D0826 LF, OH, LOH	51.02511.7550	MOTO0358
4.	Klip KPL	87-136500-00		99 339 600	Ø108 EUIII	D0836 LF, LOH, LUH	51.02511.6091	MOTO0767
5.	Klip KPL	87-280200-10	228 22 00	92 824 600	Ø125 normal	D2566 (170-240 KS)	51.02501.0459	MOTO0638
6.	Klip KPL	87-280400-00	228 82 00	93 274 600	Ø125 turbo	D2566 (230-320KS)	51.02501.0436	MOTO0415
7.	Klip KPL	87-283100-00	228 98 00	90 583 600	Ø128 EI turbo	D2866 (260-460KS)	51.02501.0886	MOTO0551
8.	Klip KPL	87-283100-30	228 90 00	90 334 600	Ø128 turbo	D2866 (260-420KS)	51.02501.0713	MOTO0865
9.	Klip KPL	87-283100-60	228 91 00	90 341 600	Ø128	D2866 (240-290KS)	51.02501.0787	MOTO0308
10.	Klip KPL	87-283100-80	228 31 00	90 578 600	Ø128 EUIII turbo	D2866 LF16-37, LOH23-26, LUH20-26	51.02511.7271	MOTO0631
11.	Klip KPL	87-143800-00	229 05 00	94 846 600	Ø128 EUIII, III	D2876 LF03, 4, 6	51.02511.0372	MOTO0293

MAN								
Poz.	Naziv	Federal Mogul broj	Mahle broj	KS broj	Dimenzije (mm)	Tip motora	OE broj	RAPIDEX broj
12.	Klip KPL	87-143800-10	229 05 10	94 847 600	Ø128 EUIII, III	D2876 LF03, 4, 14, 17	51.02511.0378	MOTO0294
13.	Klip KPL	87-143800-20	229 05 20	94 848 600	Ø128 EUIII, III	D2876 LF03, 4, 14, 17	51.02511.0379	MOTO0866
14.	Klip KPL	87-143800-30	229 04 00	99 330 600	Ø128 EUIII turbo	D2866 LF23 LOH27 LUH23	51.02500.6023	MOTO0307
15.	Klip KPL	87-143800-40	229 04 10	99 331 600	Ø128 EUIII turbo	D2866 LF23 LOH27 LUH23	51.02511.0430	MOTO0867
16.	Klip KPL	87-124500-00	228 14 00	94 394 600	Ø128 EUIII turbo	D2876 LF02	51.02511.0431	MOTO0292
17.	Klip KPL	87-423000-00			Ø120 EUIV	D2066 LF01	51.02500.6161	MOTO0129
18.	Košuljica	14-027680-00	227 WT 39	89 470 110	Ø108	D0824, 0826	51.01201.0378	MOTO0403
19.	Košuljica	14-450370-00	227 WN 32	89 056 110	Ø125	D2565, 2566	51.01201.0296	MOTO0605
20.	Košuljica	14-452920-00	227 WN 37	89 186 110	Ø128 (10,07)	D2865, 2866, 2876	51.01201.0309	MOTO0616
21.	Košuljica	14-450030-00	227 WN 42	89 518 110	Ø128 (10,27)	D2865, D2866, D2876	51.01201.0344	MOTO0760
22.	Košuljica	14-452930-00	227 WN 43	89 324 110	Ø128 (10,57)	D2865, D2866, 2876	51.01201.0324	MOTO0688
23.	Košuljica	14-452910-00	227 WN 34	89 092 110	Ø128 (253)	D2865, D2866	51.01201.0305	MOTO0760
24.	Košuljica	14-450630-00			Ø120	D2066 LF01 EUIV	51.01201.0417	MOTO0777
25.	Karike	08-285900-00	227 33 NO	80 00146 10	Ø108 (3, 2,5, 4)	D0824, D0826	51.02503.7003	MOTO0224
26.	Karike	08-280200-00	228 05 NO	80 00151 10	Ø125 (3, 3, 5) turbo	D2565, D2566	51.02503.7006	MOTO0505
27.	Karike	08-280400-10	228 82 NO	80 00154 10	Ø125 (3,5, 3, 5)	D2565, D2566	51.02503.0530	MOTO0226
28.	Karike	08-283100-00	228 90 NO	80 00155 60	Ø128 (3,5, 3, 5)	D2865, D2866	51.02503.7007	MOTO0731
29.	Karike	08-104300-00 08-143800-00	227 01 NO	80 00300 10	Ø128 (4, 3, 4)	D2876, D2866 LF23	51.02503.0781	MOTO0291
30.	Karike	08-423000-00			Ø120 (3,5, 3, 4)	D2066 LF01 EUIV	51.02503.0787	MOTO0126

MAN								
Poz.	Naziv	Federal Mogul broj	Mahle / Miba broj	KS broj	Dimenzije (mm)	Tip motora	OE broj	RAPIDEX broj
31.	Ležajevi radilice - leteći	71-3660/6	227PL20020		65 x 69 x 31	D0826	51.02410.0491	MOTO0427
32.	Ležajevi radilice - leteći	71-3938/6			70 x 74 x 27	D836LF, LOH, LUH EUIII	51.02410.6638	MOTO0868
33.	Ležajevi radilice - leteći	71-3561/5	1304P50	87 506 600	90 x 95 x 36,20	D2565, 2865	51.02410.6402	MOTO0400
34.	Ležajevi radilice - leteći	71-3561/6	1304P60	87 406 600	90 x 95 x 36,20	D2566, 2866	51.02410.6466	MOTO0441
35.	Ležajevi radilice - leteći	71-3637/6	1795P60	78 901 600	90 x 95 x 36,20 -sputer	D2866 (340-480KS)	51.02410.6533	MOTO0757
36.	Ležajevi radilice - leteći	71-3812/6	1831P60		90 x 95 x 36,20 -sputer	D2876 LF	51.02410.6632	MOTO0526
37.	Ležajevi radilice - leteći	71-4529/6			90 x 95 x 36,20 -sputer	D2066	51.02410.0723	MOTO0128
38.	Ležajevi radilice - ležeći	H049/7	227FL20018		77 x 82 x 26		51.01114.6072	MOTO0438
39.	Ležajevi radilice - ležeći	H082/7			77 x 82 x 26		51.01113.0062	MOTO0741
40.	Ležajevi radilice - ležeći	H992/7	1305H70	87 435 600	104 x 111 x 36	D2566, 2866, 2876	51.01110.6372	MOTO0662
41.	Ležajevi radilice - ležeći	H083/7	001HL10220		104 x 111 x 36	D2866, D2876	51.01113.6073	MOTO0398
42.	Ležajevi radilice - ležeći	H1239/7			104 x 111 x 36	D2066	51.01113.0113	MOTO0869
43.	Čaura klipnjače	55-3946			42 x 46 x 35,10	D0834, D0836 EUIII	51.02405.1027	MOTO0870
44.	Čaura klipnjače	55-4532				D2066	51.02405.1046	MOTO0127
45.	Čaura klipnjače	55-2862	001BB10332	87 267 690	46 x 50 x 38,70	D2566, D2866	51.02405.0056	MOTO0245
46.	Čaura klipnjače	55-3328		87 346 690	48 x 50,6 x 38,70	D2566, D2866	51.02405.1003	MOTO0451
47.	Čaura klipnjače	55-3813			50 x 54 x 38,70	D2876	51.02405.1021	MOTO0402
48.	Čaura klipnjače	55-4532				D2066 LF23-35	51.02405.1046	MOTO0127
49.	Čaura klipnjače	55-4563				D2066 LF01	51.02405.1057	MOTO0871

MAN								
Poz.	Naziv	Federal Mogul broj	Reinz broj	Elring broj	Dimenzije (mm)	Tip motora	OE broj	RAPIDEX broj
50.	Garnitura zaptivača	20-26468-04/0	01-27660-03	921.760	Ø108	D0826 LF, LOH, LUH	51.00900.6532	MOTO0289
51.	Garnitura zaptivača		01-27660-07	804.422	Ø108	D083 LF01-05, LOH01-04	51.00900.6627	MOTO0138
52.	Garnitura zaptivača		01-37180-01	198.610	Ø120	D2066 LF	51.00900.6680	MOTO0622
53.	Garnitura zaptivača	20-26235-18/0	01-25275-11	518.346	Ø125, Ø128	D2866 LF	51.00900.6601	MOTO0321
54.	Garnitura zaptivača		01-25275-18	332.780	Ø128	D2866 LUH23, 24, 25, 27	51.00900.6648	MOTO0618
55.	Garnitura zaptivača		01-25275-17	061.690	Ø128	D2876 LF	51.00900.6635	MOTO0295
56.	Set zaptivača glave	21-26468-22/0	02-27660-02	835.641	Ø108	D0826 LF	51.00900.6550	MOTO0872
57.	Set zaptivača glave		02-37180-01	195.080	Ø120	D2066LF	51.00900.6681	MOTO0873
58.	Set zaptivača glave	21-26235-23/0	03-25275-03	834.330	Ø125, Ø128	D2866 LF	51.00900.6558	MOTO0296
59.	Set zaptivača glave		03-25275-06	298.770	Ø128	D2876	51.00900.6630	MOTO0663
60.	Zaptivač glave	30-026468-00	61-27660-30		Ø108	D0826, 834	51.03901.0351	MOTO0578
61.	Zaptivač glave		61-37180-00	021.260	Ø120	D2066 LF	51.03901.0387	MOTO0613
62.	Zaptivač glave	30-025059-20	61-25110-60	834.548	Ø125	D2566	51.03901.0342	MOTO0306
63.	Zaptivač glave	30-026235-30	61-25275-00	829.722	Ø125, Ø128	D2866, D2876	51.03901.0338	MOTO0383
64.	Zaptivač kartera	31-025060-10	71-25912-10	895.319	Ø108	D0826	51.05904.0139	MOTO0341
65.	Zaptivač kartera		71-38062-00		Ø120	D2066	51.05904.0212	MOTO0593
66.	Zaptivač kartera	31-023335-10	71-23603-10		Ø125, Ø128	D2565, D2865	51.05904.0131	MOTO0136
67.	Zaptivač kartera	31-023336-10	71-23601-10	921.084	Ø125, Ø128	D2566, D2866	51.05904.0132	MOTO0364

MAN								
Poz.	Naziv	Federal Mogul broj	Reinz broj	Elring broj	Dimenzije (mm)	Tip motora	OE broj	RAPIDEX broj
61.	Zaptivač glave		61-37180-00	021.260	Ø120	D2066 LF	51.03901.0387	MOTO0613
62.	Zaptivač glave	30-025059-20	61-25110-60	834.548	Ø125	D2566	51.03901.0342	MOTO0306
63.	Zaptivač glave	30-026235-30	61-25275-00	829.722	Ø125, Ø128	D2866, D2876	51.03901.0338	MOTO0383
64.	Zaptivač kartera	31-025060-10	71-25912-10	895.319	Ø108	D0826	51.05904.0139	MOTO0341
65.	Zaptivač kartera		71-38062-00		Ø120	D2066	51.05904.0212	MOTO0593
66.	Zaptivač kartera	31-023335-10	71-23603-10		Ø125, Ø128	D2565, D2865	51.05904.0131	MOTO0136
67.	Zaptivač kartera	31-023336-10	71-23601-10	921.084	Ø125, Ø128	D2566, D2866	51.05904.0132	MOTO0364
68.	Zaptivač kartera		71-33488-00		Ø128	D2866, D2876	51.05904.0189	MOTO0322
69.	Semering radilice	50-306595-70	81-27522-10	749.983	66 x 90 x 12	D0826	51.01510.0237	OSTA0277
70.	Semering radilice	50-305115-00	81-33801-00	323.772	110 x 130 x 13	D0826	51.01510.0151	MOTO0683
71.	Semering radilice	31-020252-10			85 x 104,3 x 10,8	D0836	51.01510.0005	OSTA0313
72.	Semering radilice		81-38069-00	158.510	100 x 130 x 12	D2066	51.01510.6008	MOTO0627
73.	Semering radilice	50-307027-70			105 x 130 x 12	D2566, D2866	51.01510.0145	MOTO0553
74.	Semering radilice		81-23112-30	766.852	105 x 130 x 12 PTFE	D2566, D2866, D2876	51.01510.0197	MOTO0305
75.	Semering radilice	50-305151-00		090.158	120 x 140 x 13	D2566, D2866, D2876	51.01510.0133	OSTA0234
76.	Semering radilice		81-23113-30	766.852	120 x 140 x 13 PTFE	D2566, D2866, D2876	51.01510.6004	MOTO0304



MERCEDES								
Poz.	Naziv	Federal Mogul broj	Mahle broj	KS broj	Dimenzije (mm)	Tip motora	OE broj	RAPIDEX broj
1.	Klip KPL	87-174300-00	004 45 10	90 274 800	Ø97,00	OM352	352 030 17 19	MOTO0588
2.	Klip KPL	87-178200-20	004 50 00	92 581 600	Ø97,00	OM352	352 030 87 18	MOTO0738
3.	Klip KPL	87-740000-50	002 79 00	93 831 960	Ø97,50	OM364, 366	366 030 26 17	MOTO0615
4.	Klip KPL	87-740000-40	002 80 00	93 951 600	Ø97,50	OM366, 357	366 030 10 17	MOTO0384
5.	Klip KPL	87-288800-00	002 98 00	91 550 600	Ø97,50	OM366 EU1	366 030 05 18	MOTO0577
6.	Klip KPL	87-740000-10	003 02 00	91 598 600	Ø97,50	OM366 EU1 turbo	366 030 01 18	MOTO0626
7.	Klip KPL	87-740000-20	002 99 00	92 525 700	Ø97,50	OM366 EU1 turbo	366 030 10 18	MOTO0637
8.	Klip KPL	87-740000-00	002 81 00	94 333 600	Ø97,50	OM366 EU2 turbo	366 030 14 18	MOTO0528
9.	Klip KPL	87-289300-00	003 16 00	94 705 600	Ø102	OM904, 906, EU2	906 030 05 17	MOTO0545
10.	Klip KPL	87-176800-00	003 45 00	92 306 600	Ø125	OM402, 403, 404	403 030 47 17	MOTO0673

MERCEDES								
Poz.	Naziv	Federal Mogul broj	Mahle broj	KS broj	Dimenzije (mm)	Tip motora	OE broj	RAPIDEX broj
11.	Klip KPL	87-176000-10	003 62 00	93 231 600	Ø125	OM401A, 402LA turbo	402 030 05 17	MOTO0353
12.	Klip KPL	87-181700-00	003 66 10	93 484 602	Ø128	OM421-424	423 030 11 17	MOTO0501
13.	Klip KPL	87-179300-90	003 76 00	90 220 602	Ø128	OM441-444	422 030 08 17	MOTO0416
14.	Klip KPL	87-179300-10	003 77 00	94 512 600	Ø128	OM441-444	422 030 88 17	MOTO0385
15.	Klip KPL	87-179300-85	003 91 00	94 512 600	Ø128	OM441-444	442 030 13 37	MOTO0750
16.	Klip KPL	87-179300-80	003 76 00	90 220 602	Ø128	OM441-444	442 030 04 37	MOTO0671
17.	Klip KPL	87-179300-90	003 76 00	90 220 602	Ø128	OM441-444	442 030 11 17	MOTO0416
18.	Klip KPL	87-179300-65	003 76 00	90 220 602	Ø128	OM441-444	422 037 08 16	MOTO0134
19.	Klip KPL	87-179300-15	003 93 00	94 331 600	Ø128	OM441, 442LA EU1	442 030 13 17	MOTO0630
20.	Klip KPL	87-179300-05	003 90 00	94 681 600	Ø128	OM441, 442LA EU2	442 030 31 17	MOTO0564
21.	Klip KPL	87-179300-30	003 91 00	94 512 600	Ø128	OM447H 1985→	442 030 05 37	MOTO0639
22.	Klip KPL	87-179300-60	003 92 00	94 956 600	Ø128	OM442A EU1	442 030 30 17	MOTO0257
23.	Klip KPL	87-179300-70	003 67 00	93 485 600	Ø128	OM421-424A	442 030 03 37	MOTO0597
24.	Klip KPL	87-141800-00	004 61 00	99 948 600	Ø128	OM457 EU3	460 030 02 37	MOTO0666
25.	Klip KPL	87-743200-00	003 78 00	90 614 600	Ø130	OM441-444	444 030 04 17	MOTO0460
26.	Klip KPL	87-289600-00	001 23 00	40 448 600	Ø130	OM501, 502 96→2001	541 037 00 20	MOTO0414
27.	Klip KPL	87-136000-00			Ø130	OM501, 502, 2001→	541 030 32 37	MOTO0354
28.	Košuljica	14-021850-00	004WV08	89 178 190	Ø97	OM352	352 011 18 10	MOTO0412
29.	Košuljica	14-025800-00	004WV09	89 177 190	Ø97	OM352	352 011 16 10	MOTO0411
30.	Košuljica	14-025801-00	004WV13	89 178 190	Ø97	OM352	352 011 22 10	MOTO0410
31.	Košuljica	14-012260-00	004WV10	89 198 190	Ø97,5	OM366	366 011 00 01	MOTO0718

MERCEDES								
Poz.	Naziv	Federal Mogul broj	Mahle broj	KS broj	Dimenzije (mm)	Tip motora	OE broj	RAPIDEX broj
32.	Košuljica	14-028610-00	004WV18	89 513 190	Ø102	OM904, 906	906 011 01 10	MOTO0407
33.	Košuljica	14-451660-00	003WN14	89 181 110	Ø125	OM401-404	403 011 11 10	MOTO0641
34.	Košuljica	14-458110-00	003WN24	89 380 110	Ø125	OM401, 402EU1	403 011 11 10	MOTO0535
35.	Košuljica	14-452370-00	003WN16	89 192 110	Ø125	OM407	407 011 09 10	MOTO0534
36.	Košuljica	14-456980-00	003WN26	89 390 110	Ø128	OM447	447 011 01 10	MOTO0598
37.	Košuljica	14-451160-00	003WN15	89 180 110	Ø128	OM421-444	442 011 04 10	MOTO0502
38.	Košuljica	14-452030-00	003WN25	89 389 110	Ø128	OM421-444	444 011 01 10	MOTO0531
39.	Košuljica	14-452390-00	003WN28	89 395 110	Ø128	OM421-444	423 011 00 10	MOTO0874
40.	Košuljica	14-450380-00	001WN21	89 563 110	Ø128	OM457EU3	457 011 00 10	MOTO0592
41.	Košuljica	14-450250-00	003WN31	89 594 110	Ø130	OM501, 502	541 011 07 10	MOTO0510
42.	Košuljica	14-458580-00	003WN32	89 594 110	Ø130	OM501, 502	541 011 03 10	MOTO0686
43.	Košuljica	14-456330-00	003WN23	89 396 110	Ø130	OM441-444	442 011 00 10	MOTO0459
44.	Karika	08-174300-10	00445GO	800 010 910	Ø97	OM352	352 030 05 24	MOTO0679
45.	Karika	08-740000-00	00280NO	800 019 213	Ø97,50	OM366A	376 030 00 24	MOTO0465
46.	Karika	08-288800-00	00298NO	800 526 100	Ø97,50	OM366EU1	366 030 04 24	MOTO0469
47.	Karika	08-289300-00	00316VO	800 037 110	Ø102	OM904, 906EU2	30309724	MOTO0223
48.	Karika	08-176800-10	00345GO	800 011 211	Ø125	OM401-404	402 030 13 0	MOTO0759
49.	Karika	08-176000-00	00362NO	800 019 411	Ø125	OM401EU1 OM402EU1	402 030 01 24	MOTO0478
50.	Karika	08-181700-00		800 019 511	Ø128	OM421-424	421 030 00 18	MOTO0221
51.	Karika	08-179300-10	00376NO	800 019 510	Ø128	OM421-444LA	422 030 00 24	MOTO0474
52.	Karika	08-289600-00	00123VO	800 032 812	Ø130	OM501-502 OM501-502	541 030 00 24	MOTO0468
53.	Karika	08-743200-00	00378NO	800019710	Ø130	OM441-444	444 030 01 24	MOTO0453

MERCEDES								
Poz.	Naziv	Federal Mogul broj	Mahle / Miba broj	KS broj	Dimenzije (mm)	Tip motora	OE broj	RAPIDEX broj
54.	Ležajevi radilice - leteći	71-3572/6	001PS10000	87 428 600	60 x 65 x 29,4	OM352 OM366	366 030 00 60	MOTO0439
55.	Ležajevi radilice - leteći	71-3850/6	001PL19799	77 824 600	70 x 75 x 28,30	OM906	906 038 00 10	MOTO0492
56.	Ležajevi radilice - leteći	71-3009	001PL10264	87 404 600	90 x 65 x 31	OM401-404	422 038 01 10	MOTO0446
57.	Ležajevi radilice - leteći	71-3693/6	001PS10764	78 902 600	90 x 95 x 26,7	OM401, OM421, OM441LA	441 038 15 11	MOTO0496
58.	Ležajevi radilice - leteći	71-3638	001PL10266	78 897 600	90 x 95 x 31	OM421-444	421 030 05 60	MOTO0498
59.	Ležajevi radilice - leteći	71-3561/6	001PS18098	87 505 600	90 x 95 x 36,20	OM407-447	407 038 01 10	MOTO0441
60.	Ležajevi radilice - leteći	71-3893/6	001PS19805	77 723 600	90 x 95 x 36,20	OM457LA	407 038 12 10	MOTO0488
61.	Ležajevi radilice - leteći	71-3835	001PL19619	77 547 600	94 x 99 x 26,60	OM501LA	541 030 00 60	MOTO0493
62.	Ležajevi radilice - leteći	71-3868	001PL19628	77 550 600	94 x 99 x 35	OM502LA	542 030 07 60	MOTO0489
63.	Ležajevi radilice - ležeći	H712/7	001HL10279	87 426 600	88 x 93 x 24,10	OM352, OM352A	352 033 07 02	MOTO0252
64.	Ležajevi radilice - ležeći	H048/7	001HL1835	77 265 600	88 x 93 x 24,10	OM366LA	366 030 03 40	MOTO0635
65.	Ležajevi radilice - ležeći	H067/7	001AL19792	77 539 600	86 x 91 x 23,30	OM906LA	906 033 07 02	MOTO0437
66.	Ležajevi radilice - ležeći	H821/4	001HS10743	87 403 600	104 x 111 x 30,5	OM401, OM421, OM441	401 586 50 03	MOTO0428
67.	Ležajevi radilice - ležeći	H821/5	001HS10003	87 401 604	104 x 111 x 30,5	OM402, OM422, OM442	402 586 20 03	MOTO0424
68.	Ležajevi radilice - ležeći	H821/6	001HS1007	87 399 600	104 x 111 x 30,5	OM403, OM423 OM443	403 030 00 40	MOTO0420
69.	Ležajevi radilice - ležeći	H821/7	001HS10743	87 397 600	104 x 111 x 30,5	OM404, OM424, OM444	404 586 50 03	MOTO0875
70.	Ležajevi radilice - ležeći	H992/7	001HS18100	87 503 600	104 x 111 x 36	OM407, OM427 OM447	407 030 06 40	MOTO0662
71.	Ležajevi radilice - ležeći	H063/4	001HS19630	77 548 600	108 x 115 x 33,5	OM501	541 030 01 40	MOTO0509

MERCEDES								
Poz.	Naziv	Federal Mogul broj	Mahle / Miba broj	KS broj	Dimenzije (mm)	Tip motora	OE broj	RAPIDEX broj
72.	Ležajevi radilice - ležeći	H064/5	001HS19631	77 549 600	108 x 115 x 33,5	OM502	542 030 02 40	MOTO0483
73.	Čaura klipnjače	55-2535	001BS10713	87 354 693	36 x 39 x 34,5	OM352, 352A	352 038 11 50	MOTO0359
74.	Čaura klipnjače	01-3438.			32 x 35 x 21	OM352, 352A	352 038 13 50	MOTO0374
75.	Čaura klipnjače	55-3854	001BB19797		40 x 44 x 33,7	OM904, 906	904 038 05 50	MOTO0450
76.	Čaura klipnjače	55-2862	001BB10332	87 267 690	46 x 50 x 38,70	OM401-444	403 038 02 50	MOTO0245
77.	Čaura klipnjače	55-3328	001BB19423	87 346 690	48 x 50,6 x 38,70	OM401-444	403 038 04 50	MOTO0451

MERCEDES								
Poz.	Naziv	Federal Mogul broj	Reinz broj	Elring broj	Dimenzije (mm)	Tip motora	OE broj	RAPIDEX broj
78.	Garnitura zaptivača	20-26026-05/0	01-27350-06	826.871	Ø97	OM352	352 010 26 21	MOTO0691
79.	Garnitura zaptivača	20-26026-07/0	01-27350-09	826.936	Ø97	OM352A	352 568 12 90	MOTO0697
80.	Garnitura zaptivača	20-2606-06/0	01-27350-07	813.877	Ø97,50	OM366	366 010 61 20	MOTO0876
81.	Garnitura zaptivača	20-26235-41/0	01-25105-30	826.391	Ø125, Ø128	OM401, 421, 441	423 010 04 20	MOTO0378
82.	Garnitura zaptivača	20-26235-42/0	01-25105-33	826.642	Ø125, Ø128	OM402, 422, 442	422 010 04 80	MOTO0379
83.	Garnitura zaptivača	20-26235-43/0	01-25105-32	826.626	Ø125, Ø128	OM403, 423, 443	423 010 06 80	MOTO0461
84.	Garnitura zaptivača	20-26235-44/0	01-25105-44	826.677	Ø125, Ø128	OM404, 424, 444	424 010 04 20	MOTO0877
85.	Garnitura zaptivača	20-26235-47/0	01-24105-34	827.568	Ø125, Ø128	OM407, 427, 447	447 010 07 20	MOTO0549
86.	Garnitura zaptivača	22-28742-00/0½	01-34190-01	151.780	Ø130	OM501	541 010 13 05	MOTO0633
87.	Garnitura zaptivača	22-28744-00/0½	01-34190-03		Ø130	OM502	542 010 11 05	MOTO0878
88.	Garnitura zaptivača		01-36115-01	058.550	Ø102	OM906	906 010 15 05	MOTO0137
89.	Set zaptivača glave	21-26026-21/0	02-27350-05	813.842	Ø97	OM352	352 010 26 21	MOTO0879

MERCEDES								
Poz.	Naziv	Federal Mogul broj	Reinz broj	Elring broj	Dimenzije (mm)	Tip motora	OE broj	RAPIDEX broj
90.	Set zaptivača glave	21-26026-52/0	02-27350-04	813.877	Ø97,50	OM366	366 010 61 20	MOTO0880
91.	Set zaptivača glave	21-26235-26/0	03-25105-08	413.810	Ø125, Ø128	OM400, OM420, OM440	444 010 01 20	MOTO0118
92.	Set zaptivača glave	21-28700-50/0	03-34190-01	447.214	Ø130	OM501, OM502	541 010 11 20	MOTO0678
93.	Zaptivač glave	30-026026-50	61-27350-40	760.677	Ø97	OM352, OM352A	366 016 06 20	MOTO0382
94.	Zaptivač glave	30-026235-30	61-25105-15	451.690	Ø125, Ø128	OM400, OM420, OM440	422 016 04 20	MOTO0381
95.	Zaptivač glave		61-34285-10	002.281	Ø128	OM457	457 016 11 20	MOTO0676
96.	Zaptivač glave	30-028700-00	61-34190-10	052.480	Ø130	OM501, OM502 ← 357749	541 016 11 20	MOTO0380
97.	Zaptivač glave	30-030172-00	61-37190-00	862.562	Ø130	OM501, OM502 357749 →	541 016 13 20	MOTO0645
98.	Garnitura zaptivača kartera	23-26826-01/0	10-12413-02	284.734	Ø97	OM352, OM352A, OM366	352 010 08 80	MOTO0881
99.	Zaptivač kartera	31-023576-10	71-23922-10	765.694	Ø125, Ø128	OM401, OM421, OM441	441 014 00 22	MOTO0337
100.	Zaptivač kartera	31-029967-00	71-23443-20	765.716	Ø125, Ø128	OM402, OM422, OM442	442 014 02 22	MOTO0336
101.	Zaptivač kartera	31-022812-10	71-23347-20	775.347	Ø125, Ø128	OM403, OM423, OM443	443 014 00 22	MOTO0338
102.	Zaptivač kartera	31-024668-10	71-26976-10	775.789	Ø125, Ø128	OM404, OM424, OM444	444 014 00 22	MOTO0882
103.	Zaptivač kartera	31-023336-10	71-23601-10	768.367	Ø125, Ø128	OM407, OM427, OM447	447 014 00 22	MOTO0364
104.	Zaptivač kartera	31-028743-00	71-34892-00	445.980	Ø130	OM501	541 014 03 22	MOTO0346
105.	Zaptivač kartera	31-028744-00	71-34894-00	445.990	Ø130	OM502	542 014 03 22	MOTO0345

MERCEDES								
Poz.	Naziv	Federal Mogul broj	Reinz broj	Elring broj	Dimenzije (mm)	Tip motora	OE broj	RAPIDEX broj
106.	Semering radilice	50-306357-50		283.983	65 x 90 x 15	OM352, OM366	009 997 77 47	OSTA0310
107.	Semering radilice	50-306307-00	81-20504-40	553.272	65 x 90 x 13	OM352, OM366	014 997 16 47	OSTA0310
108.	Semering radilice	31-024323-30	71-24488-10	837.549	90 x 107 x 8	OM352, OM366	001 997 41 41	MOTO0883
109.	Semering radilice	50-307027-70		524.973	105 x 130 x 12	OM400, OM420, OM440	019 997 66 47	OSTA0235
110.	Semering radilice	50-306632-50		562.920	120 x 140 x 13	OM400, OM420, OM440	014 997 13 47	OSTA0234
111.	Semering radilice		81-23113-00	766.852	120 x 140 x 13 PTFE	OM400, OM420, OM440	013 997 14 47	MOTO0304
112.	Semering radilice		81-23112-30	766.852	105 x 130 x 12 PTFE	OM400, OM420, OM440	014 997 46 47	MOTO0305



DELOVI MOTORA

Poz.	Naziv dela	Tip vozila / Dimenzije (mm)	OE broj	RAPIDEX broj
1.	RADILICA	MAN D2566, D2866	51.02100.6037 51.02100.7515 51.02100.7613 51.02100.7708 51.02100.7741	MOTO0884
2.	RADILICA	MAN D2876	51.02100.6018 51.02100.6038 51.02100.6044 51.02100.7706	MOTO0885
3.	RADILICA	MERCEDES OM441 A/LA I=26,7	441 030 21 01	MOTO0886
4.	RADILICA	MERCEDES OM402, 422, 442 BM901	422 030 43 01 422 030 37 01	MOTO0887
5.	RADILICA	MERCEDES ACTROS OM501	541 030 08 01	MOTO0888
6.	KLIPNJAČA	MAN D2566, D2866 d1=46, d2=95, L=251	51.02401.6141 51.02401.6214 51.02401.6244	MOTO0889
7.	KLIPNJAČA	MAN D2866, D2876	51.02400.6011 51.02400.6049 51.02401.6242 51.02401.6243 51.02401.6282	MOTO0131
8.	KLIPNJAČA	MERCEDES OM400, 420, 440 d1=46, d2=95, L=256	403 030 17 20 422 030 03 20 422 030 04 20	MOTO0264

DELOVI MOTORA				
Poz.	Naziv dela	Tip vozila / Dimenzije (mm)	OE broj	RAPIDEX broj
9.	KLIPNJAČA	MERCEDES OM400, 420, 440 d1=46, d2=95, L=256 trapez	442 030 00 20 442 030 02 20	MOTO0356
10.	KLIPNJAČA	MERCEDES ACTROS OM501	541 030 03 20 541 030 05 20	MOTO0890
11.	GLAVA MOTORA	MAN D2566, D2865, D2866	51.03101.6585	MOTO0891
12.	GLAVA MOTORA	MAN D2866LF23-28, D2876LF03-11/14/17 LOH	51.03100.6053 51.03100.6802 51.03100.6807 51.03101.6824	MOTO0892
13.	GLAVA MOTORA	MERCEDES OM441, OM422, OM442	442 010 06 20	MOTO0893
14.	GLAVA MOTORA	MERCEDES ACTROS OM501, OM502	541 010 64 20 541 010 53 20	MOTO0894
15.	BREGASTA OSOVINA	MAN D2566, D2866	51.04401.6271 51.04401.6231 51.04401.6179	MOTO0895
16.	BREGASTA OSOVINA	MAN D2866 LF, LOH, D2876LF, LOH	51.04401.5053	MOTO0896
17.	BREGASTA OSOVINA	MERCEDES OM422A, LA, OM442A, LA	422 050 22 01	MOTO0515
18.	BREGASTA OSOVINA	MERCEDES ACTROS OM501	541 050 18 01 541 050 16 01 541 050 20 01 541 050 23 01	MOTO0897
19.	VIJAK KLIPNJAČE	MAN D2566, D2866, D2876 M16 x 1,5	51.90020.0139	MOTO0049
20.	VIJAK KLIPNJAČE	MAN D2866, D2876 M14 x 1,5	51.90490.0021	MOTO0139
21.	VIJAK KLIPNJAČE	MAN D2866, D2876 M16 x 1,5	51.90021.0004	MOTO0200
22.	VIJAK KLIPNJAČE	MERCEDES OM400, OM420, OM440 M16x1,5x67 mm	403 038 02 71	MOTO0173
23.	VIJAK KLIPNJAČE	MERCEDES OM400, OM420, OM440 M16 x 1,5 x 67,5	442 038 00 71	MOTO0898
24.	VIJAK KLIPNJAČE	MERCEDES ACTROS OM501, OM502 M16 x 1,5 x 73,5	541 038 00 71	MOTO0172







1



DELOVI MOTORA				
Poz.	Naziv dela	Tip vozila / Dimenzije (mm)	OE broj	RAPIDEX broj
25.	PODIZAČ VENTILA	MAN D0226, D0826, D0836	51.04301.0089	MOTO0899
26.	PODIZAČ VENTILA	MAN D2566, D2866, D2876	51.04301.0065	MOTO0056
27.	PODIZAČ VENTILA	MAN D2566, D2866, D2876 ojačan	51.04301.0109	MOTO0140
28.	PODIZAČ VENTILA	MERCEDES OM400, 420, 440	403 054 18 01	MOTO0900
29.	PODIZAČ VENTILA	MERCEDES OM400, 420, 440 ojačan	476 050 00 25	MOTO0901
30.	VENTIL PUMPE ULJA	MAN D2566, D2866, D2876	51.05405.5013	MOTO0057
31.	VENTIL PUMPE ULJA	MERCEDES OM400, OM420, OM440, OM501, OM502	541 180 07 15	MOTO0507
32.	VENTIL PUMPE ULJA	MERCEDES OM400, OM420, OM440	442 180 00 15	MOTO0058
33.	ULJNA DIZNA	MAN D2566, D2866	51.01601.50 66	MOTO0902
34.	ULJNA DIZNA	MAN D2566, D2866, D2876	51.01601.50 83	MOTO0903
35.	ULJNA DIZNA	MERCEDES OM400, OM420, OM440	442 180 05 43	MOTO0142
36.	ULJNA DIZNA	MERCEDES ACTROS OM501, 502	541 180 08 43	MOTO0201
37.	SEPARATOR ULJA-ODUŠAK	MAN D2566, D2866, D2876	51.01804.70 23	MOTO0046
38.	SEPARATOR ULJA-ODUŠAK	MAN D2566, D2866	51.01804.70 26	MOTO0047
39.	SEPARATOR ULJA-ODUŠAK	MAN D2865, D2866, D2876	51.01804.70 28	MOTO0048
40.	SEPARATOR ULJA-ODUŠAK	MAN D2866, D2876	51.01804.70 37	MOTO0165
41.	SEPARATOR ULJA-ODUŠAK	MERCEDES OM400, OM420, OM440	000 018 38 35	MOTO0311
42.	SEPARATOR ULJA-ODUŠAK	MERCEDES OM400, OM420, OM440	000 018 37 35	MOTO0904



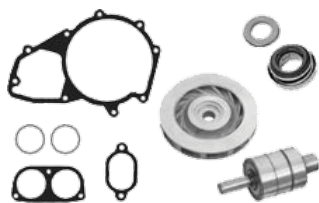



1



PUMPE VODE						
Slika	Poz.	Tip vozila	Tip motora	Frimatec broj	OE broj	RAPIDEX broj
	1.	DAF 95XF	XF280	220953	1609871	MOTO0071
	2.	IVECO EuroTrakker, Trakker, Stralis	F3BE0681G	2201103	500356553	MOTO0012
	3.	MAN F90, BUS	D2566, D2866	220728	51.06500.6282	MOTO0287
	4.	MAN F90, F2000, BUS Set za remont pumpe	D2865, D2866	220789 225775	51.06500.6408 51.06599.6012	MOTO0286 MOTO0273
	5.	MAN F90, F2000	D2865, D2866, D2876, D2840	220876	51.06500.6492	MOTO0283
	6.	MAN F90, F2000	D2865LF20, D2866LF/LF20	220999	51.06500.6547	MOTO0278



PUMPE VODE						
Slika	Poz.	Tip vozila	Tip motora	Frimatec broj	OE broj	RAPIDEX broj
	7.	MAN F2000	D2865LF21-24, D2866LF06/0920, D2876LF02, D2840	220816	51.06500.6479	MOTO0285
	8.	MAN F2000	D2865, D2840, D2866, D2876	220997	51.06500.6546	MOTO0279
	9.	MAN	D0826, D0834, D0836	2201066	51.06500.6606	MOTO0263
	10.	MAN TGA	D2876	2201065	51.06500.7066	MOTO0016
	11.	MAN TGS, TGX	D2066LUH01-48 D2876LF01	2201091	51.06500.6646	MOTO0011
	12.	MAN L2000	D0824, D0826	2201045	51.06500.6515	MOTO0776





PUMPE VODE						
Slika	Poz.	Tip vozila	Tip motora	Frimatec broj	OE broj	RAPIDEX broj
	13.	MAN F2000	D2865, D2866, D2876	2201108	51.06500.6457	MOTO0026
	14.	MERCEDES 814-2420	OM365, OM366	220845	366 200 59 01	MOTO0773
	15.	MERCEDES 810-1620	OM352, OM362, OM366LA	220783	353 200 56 01	MOTO0774
	16.	MERCEDES 1019-6036, BUS	OM401-403, 421-423, 440-442, 445,446	220728	403 200 51 01	HLAĐ0079
	17.	MERCEDES 1019-6036, BUS Set za remont pumpe 220728	OM401-403, 421-423, 440-442, 445,446	225747	403 200 69 01	MOTO0274
	18.	MERCEDES 1222-6036, BUS Set za remont pumpe	OM441-OM443	220789 225775	403 200 57 01	MOTO0286 MOTO0273

PUMPE VODE						
Slika	Poz.	Tip vozila	Tip motora	Frimatec broj	OE broj	RAPIDEX broj
	19.	MERCEDES ATEGO	OM904, OM906	220998	904 200 04 01	VESA0434
	20.	MERCEDES ATEGO Set za remont pumpe 220998	OM904, OM906	225816	904 200 00 04	MOTO0271
	21.	MERCEDES ATEGO	OM 906	2201075	906 201 16 01	MOTO0785
	22.	MERCEDES AXOR	OM457, OM457LA	2201053	457 200 05 01	MOTO0270
	23.	MERCEDES ACTROS MP1 Set za remont pumpe	OM541.920(501) LA	220880 225803	541 200 12 01	MOTO0282 VESA0433
	24.	MERCEDES ACTROS MP1 Sa retarderom	OM541.926 (502) LA	220881	542 201 04 01	MOTO0281

PUMPE VODE						
Slika	Poz.	Tip vozila	Tip motora	Frimatec broj	OE broj	RAPIDEX broj
	25.	MERCEDES ACTROS MP2 2003→	OM541.920 (501) LA	2201070	542 200 17 01	MOTO0277
	26.	MERCEDES ACTROS MP2 Sa retarderom 2003→	OM541.926 (502) LA	2201071	542 200 18 01	MOTO0276
	27.	MERCEDES ACTROS MP2/MP3 Sa retarderom	OM541.940-944	2201072	542 200 24 01	MOTO0146
	28.	SCANIA 92, 93	DN9, DS9, DSC9	220834	1 377 571	MOTO0284
	29.	SCANIA 94	DSC9	2201079	1 380 897	MOTO0275
	30.	SCANIA 114, 124	DSC11, DSC12	220941	1 372 365	MOTO0105

PUMPE VODE						
Slika	Poz.	Tip vozila	Tip motora	Frimatec broj	OE broj	RAPIDEX broj
	31.	SCANIA 144	DSC14	220940	1 365 841	MOTO0010
	32.	VOLVO FL10, FL12, FH12	D12A, D12A340, D12A380, D12A420	220945	1547155	MOTO0280
	33.	VOLVO FH16	D16C550, D16C610	2201101	3161436	MOTO0147

PUMPE ULJA					
Slika	Poz.	Tip vozila	Tip motora	OE broj	RAPIDEX broj
	1.	MAN F90, MERCEDES MK, SK, NG Do broja motora →121799	OM401, 402LA, 403, OM421, 422, 441A/LA, OM442, D2565, 2566, 2865, 2866	403 180 17 01 51.05100.6133	MOTO0778
	2.	MAN F90, MERCEDES MK, SK, NG Od broja motora 121800→	OM402LA, 403, 423, OM442A/LA, 443, D2565, 2566, 2865, 2866	423 180 05 01 51.05100.6150	MOTO0779

PUMPE ULJA					
Slika	Poz.	Tip vozila	Tip motora	OE broj	RAPIDEX broj
	3.	MAN TGA, F2000	D2865, D2866, D2867	51.05100.6262	MOTO0780
	4.	ATEGO	OM904, 906	906 180 06 01	MOTO0781
	5.	AXOR	OM457 HLA	403 180 28 01	MOTO0782
	6.	ACTROS	OM501	541 180 03 01	MOTO0783
	7.	ACTROS	OM502	542 180 02 01	MOTO0784



PUMPE UPRAVLJAČA

Poz.	Tip vozila	OE broj	RAPIDEX broj
1.	DAF 85, 95	1291230	HIDR0057
2.	DAF 75, 85, 95XF	1301265	HIDR0058
3.	MAN F90, F2000, LION'S	81.47101.6169	HIDR0059
4.	MAN TGA	81.47101.6170	HIDR0060
5.	MAN F90, F2000, TGA 18/24/26/28/32/33/35/37/40/41	81.47101.6181	HIDR0013
6.	MERCEDES 1214, 1218, 1414, 1418, 1614, 1618, 2314, 2318	000 466 71 01	HIDR0011
7.	MERCEDES LK, MK, SK, NG, O301-307, O404-407, Unimog	000 460 14 80	HIDR0010
8.	MERCEDES LK, MK, SK, NG, O301-307, O404-407, Unimog	000 460 60 80	HIDR0012
9.	MERCEDES ACTROS 1996-2003, TRAVEGO BUS	001 460 30 80	HIDR0008
10.	MERCEDES ACTROS 1996-2003	001 460 31 80	HIDR0061
11.	RENAULT MAGNUM	5000504322	HIDR0010
12.	RENAULT PREMIUM	7403986328	HIDR0062
13.	SCANIA SERIJA 2	571364	HIDR0014
14.	SCANIA SERIJA 3, SERIJA 4	1 308 495	HIDR0063
15.	SCANIA SERIJA 3, SERIJA 4 (DSC11)	1 324 223	HIDR0064
16.	SCANIA SERIJA 4 (94, 114, 124L, 144L, 164G)	1 333 790	HIDR0065
17.	SCANIA SERIJA 4 (94, 114, 124L, 144L, 164G)	1 332 653	HIDR0066
18.	VOLVO FH12/460, FM12/340, FM12/380	3172490	HIDR0067
19.	VOLVO FH12/340, FH12/380, FH12/420, FH12/460, FM12/360, FM12/380, FM12/420	3172488	HIDR0068
20.	VOLVO FH12/340, FH12/380, FH12/420, FH12/460, FM12/360, FM12/380, FM12/420	3172492	HIDR0009

TERMOSTATI						
Slika	Poz.	Tip vozila	T [°C]	Behr broj	OE broj	RAPIDEX broj
	1.	MAN F90, L/M/F2000, TGA IVECO Eurostar, Eurotech, Eurotrakker VOLVO M/G	79°C	2.105.79.300	51.06402.0044 751872 98424854	MOTO0730
	2.	MAN F/G90, L/F/M2000, TGA	83°C	2.105.83.300	51.06402.0060	MOTO0222
	3.	MERCEDES LK/LN2, LP, MK, NG, SK, T2/LN1, Unimog, Vario	71°C	2.085.71.300	001 203 32 75	MOTO0387
	4.	MERCEDES Actros, Atego, Axor, Citaro, Econic, Unimog, Vario	83°C	2.085.83	005 203 26 75	MOTO0222
	5.	MERCEDES, RENAULT, IVECO	79°C	2.085.79.300	003 203 91 75 5000 785 355 8420718	MOTO0730
	6.	MERCEDES Sprinter, MERCEDES Vito	87°C	2.426.87.355	611 200 02 15	MOTO0849

1

TERMOSTATI						
Slika	Poz.	Tip vozila	T [°C]	Behr broj	OE broj	RAPIDEX broj
	7.	DAF 95XF	75°C	2.409.75	222730	MOTO0850
	8.	DAF 2100-3600, 85, IVECO Eurostar, Turbostar	75°C	2.105.75.300	394346 98492868	MOTO0851
	9.	DAF 900-2600	75°C	1.132.75	167513	MOTO0852
	10.	DAF 2100-3600	75°C	2.085.75	390455	MOTO0853
	11.	IVECO Daily, IVECO Zeta	75°C	2.409.75	4703088	MOTO0854
	12.	IVECO Eurocargo, IVECO Zeta	79°C	2.057.79	8828492	MOTO0855

1

TERMOSTATI						
Slika	Poz.	Tip vozila	T [°C]	Behr broj	OE broj	RAPIDEX broj
	13.	IVECO Eurocargo, IVECO Zeta	79°C	6.232.79	98432310	MOTO0856
	14.	IVECO Eurotech, IVECO Turbotech	79°C	6.228.79	6131659	MOTO0857
	15.	IVECO Daily, IVECO Ducato	79°C	6.231.79	730361	MOTO0858
	16.	SCANIA 114,124,144,164	80°C	2.159.80	1 404 925	HLA0016
	17.	SCANIA 114,124,144,164	83°C	2.160.83	1 404 924	MOTO0859
	18.	SCANIA 94, 112, 113, 114, 142, 143	79°C	2.315.79	283281	MOTO0860

1

TERMOSTATI						
Slika	Poz.	Tip vozila	T [°C]	Behr broj	OE broj	RAPIDEX broj
	19.	SCANIA 114	79°C	2.093.79	0 251 899	MOTO0861
	20.	IVECO Eurotech, Eurotrakker, Stralis, VOLVO FH16, FL10, FM12	86°C	2.409.86	1665694 99431512	MOTO0862
	21.	VOLVO F12, FH12, FL6, FL7	82°C	2.409.82	1676306	MOTO0196
	22.	VOLVO F6, F7, F10, F12, FL4	81°C	1.145.81.310	1544390	MOTO0863



1



ŠPANERI I ROLERI				
Poz.	Naziv dela	Tip vozila	OE broj	RAPIDEX broj
1.	ŠPANER	DAF CF85, XF95, XF105	1690115	MOTO0792
2.	ŠPANER	DAF CF85, XF95, XF105	1695242	MOTO0793
3.	ROLER ŠPANERA	DAF CF85, XF95, XF105	1699240	MOTO0794
4.	ROLER ŠPANERA	DAF CF85, XF95, XF105	1628148	MOTO0795
5.	ŠPANER	MAN L/F2000, TGA	51.95800.7437	MOTO0104
6.	ŠPANER	MAN L/F2000, TGA	51.95800.7435	MOTO0796
7.	ŠPANER	MAN TGA	51.95800.7459	MOTO0156
8.	ŠPANER	MAN L/F2000, TGA	51.95800.7396 51.95800.7393	MOTO0188
9.	ROLER ŠPANERA	MAN TGL, TGA	51.95800.5001	MOTO0797
10.	ROLER ŠPANERA	MAN TGL	51.95800.6092	MOTO0110
11.	ROLER ŠPANERA	MAN TGA	51.95800.7431	MOTO0194
12.	ŠPANER	MERCEDES ACTROS	541 200 10 70	MOTO0369
13.	ŠPANER	MERCEDES ACTROS	541 200 11 70	MOTO0368
14.	ŠPANER	MERCEDES ACTROS	541 200 15 70	MOTO0155
15.	ŠPANER	MERCEDES ATEGO	906 200 06 70	MOTO0619

ŠPANERI I ROLERI				
Poz.	Naziv dela	Tip vozila	OE broj	RAPIDEX broj
16.	ROLER ŠPANERA	MERCEDES ATEGO	000 550 16 33	MOTO0316
17.	ROLER ŠPANERA	MERCEDES ACTROS	000 550 04 33	MOTO0317
18.	ŠPANER	SCANIA 114, 124, 144	1 545 982 1 459 988 1 503 113 1 545 982	MOTO0315
19.	ŠPANER	SCANIA 164	1 545 983 1 503 114 1 459 981	MOTO0798
20.	ROLER ŠPANERA	SCANIA 114, 124, 144, 164	1 514 086 1 514 086 1 428 940 1 353 717	MOTO0314
21.	ROLER ŠPANERA	SCANIA 114, 124, 164	1 428 941 1 514 087	MOTO0152
22.	ŠPANER	RENAULT MAGNUM	7408149855	MOTO0799
23.	ŠPANER	VOLVO FH12, FH16, FM9, FM12	8149855	MOTO0799
24.	ŠPANER	VOLVO FM7, FM9	3979979	MOTO0800
25.	ŠPANER	VOLVO B12, FM7, FM9	20739751	MOTO0801
26.	ROLER ŠPANERA	VOLVO FH12, FM9, FM12	39779924	MOTO0192
27.	ROLER ŠPANERA	VOLVO FH12, FH16, FM10	1636242	MOTO0802



KLINASTI I PK KAIŠEVI				
Poz.	Dimenzija (mm)	Tip vozila	Model vozila	RAPIDEX broj
1.	10 x 913	IVECO	Zeta 79.12	REME0080
2.	10 x 950	VOLVO	F16 (TD162, TD163)	REME0081
3.	10 x 1025	IVECO	Zeta 79.12	REME0082
4.	10 x 1070	RENAULT	MAGNUM	REME0083
5.	10 x 1200	VOLVO	FL6	REME0084
6.	10 x 1250	MAN, RENAULT	D0824	REME0085
7.	10 x 1275	MAN, RENAULT MIDLUM	D0826	REME0086
8.	10 x 1300	MAN, IVECO	Zeta, M90 (D0826)	REME0087
9.	10 x 1325	MAN	M90 (D0826)	REME0088
10.	10 x 1375	MAN	M2000, L2000	REME0089
11.	10 x 1400	MAN	M2000, L2000	REME0090
12.	10 x 1500	MAN	F2000 (D2866)	REME0076
13.	10 x 1525	MAN	F2000 (D2866)	REME0215
14.	13 x 1000	DAF	95XF, XF95	REME0216
15.	13 x 1025	DAF	95XF	REME0217
16.	13 x 1075	KÄSSBOHRER	SETRA	REME0228
17.	13 x 1200	RENAULT MIDLUM, MB, SCANIA	OM422, DSC14, DC11	REME0218

KLINASTI I PK KAIŠEVI				
Poz.	Dimenzija (mm)	Tip vozila	Model vozila	RAPIDEX broj
18.	13 x 1225	MAN, RENAULT PREMIUM	L2000 (D2866)	REME0067
19.	13 x 1250	MB, MAN, KÄSSBOHRER, SCANIA	OM422, D2866, SETRA	REME0229
20.	13 x 1275	MAN, DAF	F2000, TG, 95XF,	REME0219
21.	13 x 1300	MERCEDES, MAN, SCANIA	OM366, F2000, DSC14	VESA0541
22.	13 x 1325	IVECO, MAN, MERCEDES	EuroStar, F90, NG, O405	REME0220
23.	13 x 1350	MERCEDES, VOLVO, MAN	OM422, F12, F2000, TG	REME0091
24.	13 x 1375	RENAULT, MERCEDES, SCANIA	Premium, LK, Scania bus	REME0092
25.	13 x 1400	MAN, MERCEDES, IVECO	M90, O301, O402, EuroStar, Tech, Trakker	REME0093
26.	13 x 1425	MAN, IVECO	F90, M90, EuroTech, EuroTrakker	REME0221
27.	13 x 1450	MAN, MERCEDES, IVECO	F90, O303, O405	VESA0538
28.	13 x 1475	MAN, MERCEDES	F90, LP, NG, O405	REME0094
29.	13 x 1500	MAN, MERCEDES	F90, O301, O402, O405	REME0076
30.	13 x 1525	MAN, MERCEDES	F90, F2000, OM400-440	VESA0535
31.	13 x 1550	MAN, MERCEDES, RENAULT	M90, OM400-440, Magnum	REME0095
32.	13 x 1575	MAN, MERCEDES, SCANIA	M90, OM400-440, Serija 3	REME0222
33.	13 x 1600	DAF, MAN, SCANIA	F2300, 2500, Serija2, 3, M90	REME0223
34.	13 x 1625	MERCEDES, SCANIA	Unimog, Serija 2, 4	REME0096
35.	13 x 1750	MERCEDES, SCANIA	O305, O405, Serija 2, 3	REME0224
36.	4PK 1075	IVECO	EuroStar LD Cursor	REME0071
37.	4PK 1290	MAN	D2840	REME0097
38.	4PK 1390	MAN	D0834, D0836	REME0022
39.	5PK 1225	RENAULT	Renault Magnum	REME0098
40.	5PK 1290	RENAULT	Renault Magnum	REME0099
41.	5PK 1413	RENAULT	Renault Premium	REME0100

KLINASTI I PK KAIŠEVI				
Poz.	Dimenzija (mm)	Tip vozila	Model vozila	RAPIDEX broj
42.	5PK 1482	MAN	D2866, D2876	REME0101
43.	5PK 1525	MAN	TG, D2066, D2876	REME0102
44.	6PK 1065	RENAULT	Renault Premium	REME0103
45.	6PK 1110	RENAULT	Renault Magnum	REME0104
46.	6PK 1515	MAN	D0826	REME0105
47.	6PK 1748	RENAULT	Renault Magnum	REME0106
48.	6PK 1880	MAN	TG D2066	REME0107
49.	7PK 1753	DAF	CF85, XF95, XF105	REME0108
50.	8PK 855	MAN	TGA	REME0109
51.	8PK 880	MAN	D2866, D2876	REME0110
52.	8PK 1158	MERCEDES, MAN	Atego, Axor, OM906, 926, TG D2066	REME0111
53.	8PK 1174	MERCEDES	Atego, Axor, OM906, 926	REME0112
54.	8PK 1183	MERCEDES	Atego, Axor, OM906	REME0113
55.	8PK 1190	MERCEDES	Atego, Axor, OM906, 926	REME0114
56.	8PK 1205	MERCEDES	Actros OM501, OM502 (505161 18/19)	REME0018
57.	8PK 1215	MERCEDES	Actros OM501, OM502	REME0012
58.	8PK 1220	MERCEDES	Atego, Axor, OM906	REME0115
59.	8PK 1225	DAF	65CF, CF65	REME0116
60.	8PK 1244	MERCEDES	Atego, Axor, OM906, 926	REME0117
61.	8PK 1255	SCANIA	Scania 164	REME0118
62.	8PK 1369	MERCEDES	Atego, Axor, OM906, 926	REME0119
63.	8PK 1275	MAN	D0834, D0836	REME0120
64.	8PK 1376	MAN	D2866, D2876	REME0064
65.	8PK 1390	MERCEDES	Atego, Axor, OM906, 926	REME0121
66.	8PK 1405	MERCEDES	Atego, Axor, OM906, 926	REME0122
67.	8PK 1410	MERCEDES	Atego, Axor, OM906	REME0123
68.	8PK 1420	MERCEDES	Atego, Axor, OM906, 926	REME0020
69.	8PK 1427	MERCEDES	Atego, Axor, OM906, 926	REME0124

1

KLINASTI I PK KAIŠEVI				
Poz.	Dimenzija (mm)	Tip vozila	Model vozila	RAPIDEX broj
70.	8PK 1445	MERCEDES	Atego, Axor, OM906, 926	REME0125
71.	8PK 1480	MERCEDES	Atego, Axor, OM906, 926	REME0225
72.	8PK 1495	MAN	D0836, D2866	REME0126
73.	8PK 1510	SCANIA	Scania 124	REME0127
74.	8PK 1520	DAF	65CF, CF65	REME0128
75.	8PK 1540	MERCEDES	Atego, Axor, OM906, 926	REME0129
76.	8PK 1548	MAN	D0836	REME0130
77.	8PK 1550	SCANIA	Scania 114, 124	REME0226
78.	8PK 1580	MAN, MERCEDES	D0836, OM457LA	REME0131
79.	8PK 1585	SCANIA	Scania 114	REME0132
80.	8PK 1600	MERCEDES	OM457LA	REME0133
81.	8PK 1610	MERCEDES	OM457LA	REME0134
82.	8PK 1635	MAN	TG D2066	REME0135
83.	8PK 1655	MAN	D2066, D2676	REME0136
84.	8PK 1670	MERCEDES	Atego, Axor, OM906	REME0137
85.	8PK 1718	DAF	95XF	REME0138
86.	8PK 1720	DAF	CF85, XF95	REME0139
87.	8PK 1730	MERCEDES	Atego, Axor, OM906, OM926	REME0140
88.	8PK 1740	MERCEDES	Atego, Axor OM906, OM926	REME0141
89.	8PK 1780	MERCEDES	Atego, Axor OM906, OM926	REME0142
90.	8PK 1850	MERCEDES	Atego, Axor OM906, OM926	REME0143
91.	8PK 1910	MERCEDES	Atego, Axor OM906, OM926	REME0144
92.	8PK 1914	MERCEDES	Atego, Axor OM906, OM926	REME0145
93.	8PK 1920	MAN	D2066, D2676	REME0004
94.	8PK 1940	MERCEDES	Atego, Axor OM906, OM926	REME0146
95.	8PK 1955	MERCEDES	Atego, Axor OM906, OM926	REME0147

1

KLINASTI I PK KAIŠEVI				
Poz.	Dimenzija (mm)	Tip vozila	Model vozila	RAPIDEX broj
96.	8PK 1960	MERCEDES	Atego, Axor, OM906	REME0148
97.	8PK 1966	MERCEDES	Atego, Axor OM906, OM926	REME0149
98.	8PK 1979	MERCEDES	Atego, Axor OM906, OM926	REME0150
99.	8PK 1985	MERCEDES	Atego, Axor OM906, OM926	REME0151
100.	8PK 1993	MERCEDES	Atego, Axor, OM906	REME0152
101.	8PK 2000	MERCEDES	Atego, Axor, OM906	REME0153
102.	8PK 2040	MERCEDES	Atego, Axor OM906, OM926	REME0154
103.	8PK 2045	SCANIA	Scania 114	REME0155
104.	8PK 2050	DAF	CF85	REME0156
105.	8PK 2060	MERCEDES	Atego, Axor OM906, OM926	REME0157
106.	8PK 2080	SCANIA	Scania 164	REME0227
107.	8PK 2220	SCANIA	Scania 144	REME0158
108.	8PK 2380	DAF	75CF, CF75	REME0159
109.	8PK 2482	MERCEDES	Atego, Axor OM906, OM926	REME0160
110.	8PK 2497	MERCEDES	Atego, Axor OM906, OM926	REME0161
111.	8PK 2515	MERCEDES	Atego, Axor OM906, OM926	REME0162
112.	8PK 2523	MERCEDES	Atego, Axor OM906, OM926	REME0163
113.	8PK 2525	MERCEDES	Atego, Axor OM906, OM926	REME0164
114.	8PK 2560	MERCEDES	Atego, Axor OM906, OM926	REME0165
115.	8PK 2600	MERCEDES	Atego, Axor OM906, OM926	REME0166
116.	8PK 2850	MERCEDES	Atego, Axor OM906, OM926	REME0167
117.	9PK 1200	MAN	D0834, D0836	REME0168
118.	9PK 1330	MAN	D0824, D0826	REME0169
119.	9PK 1414	DAF	XF95, XF105	REME0170

KLINASTI I PK KAIŠEVI				
Poz.	Dimenzija (mm)	Tip vozila	Model vozila	RAPIDEX broj
120.	9PK 1680	MERCEDES	OM457LA	REME0171
121.	9PK 1725	MERCEDES, MAN	OM457LA, OM906LA, D2840	REME0172
122.	9PK 1825	MERCEDES	OM457LA, Actros OM502	REME0173
123.	9PK 1880	MERCEDES	OM457LA	REME0174
124.	9PK 1885	MERCEDES	Actros OM501, OM502	REME0061
125.	9PK 1900	MERCEDES	OM457LA	REME0175
126.	9PK 1920	MERCEDES	Actros OM501, OM502	REME0176
127.	9PK 2080	MERCEDES	OM502	REME0177
128.	9PK 2100	MERCEDES	OM457LA	REME0028
129.	9PK 2125	MERCEDES	OM457HLA	REME0178
130.	9PK 2295	MERCEDES	Actros OM501, OM502	REME0052
131.	9PK 2325	MERCEDES	Actros OM501	REME0179
132.	9PK 2338	MERCEDES	OM457LA	REME0180
133.	9PK 2835	MERCEDES	Actros OM501, OM502	REME0065
134.	9PK 2871	MERCEDES	Actros OM501, OM502	REME0024
135.	10PK 1300	MAN	D0836	REME0181
136.	10PK 1350	MERCEDES	Atego, Axor OM906	REME0182
137.	10PK 1405	MERCEDES	Atego, Axor OM906, OM926	REME0183
138.	10PK 1453	MAN	NL, Lion's (City)	REME0184
139.	10PK 1590	MERCEDES	OM457LA, OM906	REME0185
140.	10PK 1580	MAN	D0836	REME0186
141.	10PK 1620	MERCEDES	Atego, Axor OM906	REME0187
142.	10PK 1626	MERCEDES	Atego, Axor OM906	REME0188
143.	10PK 1670	MERCEDES	Atego, Axor OM906	REME0189
144.	10PK 1695	MAN	TG D2066	REME0190
145.	10PK 1745	MAN	D0836	REME0191
146.	10PK 1768	MAN	Atego, Axor OM906, OM926	REME0192
147.	10PK 1815	MERCEDES	Atego, Axor OM906	REME0193

KLINASTI I PK KAIŠEVI				
Poz.	Dimenzija (mm)	Tip vozila	Model vozila	RAPIDEX broj
148.	10PK 1850	MERCEDES	Atego, Axor OM906, OM457LA	REME0194
149.	10PK 1863	MAN	D0826	REME0195
150.	10PK 1867	MERCEDES	Atego, Axor OM906, OM457LA	REME0196
151.	10PK 1970	MERCEDES	Atego, Axor OM926	REME0197
152.	10PK 1980	MAN	D0836, D2866	REME0198
153.	10PK 2108	MAN	D2866, TGA D2876	REME0199
154.	10PK 2240	MERCEDES	Atego, Axor OM906, OM926	REME0200
155.	10PK 2340	MAN	TGA D2066, D2676	REME0201
156.	11PK 1890	MERCEDES	Actros OM501, OM502	REME0013
157.	11PK 1915	MERCEDES	Actros OM501	REME0202
158.	11PK 2017	MERCEDES	Atego, Axor OM906, OM457LA	REME0203
159.	11PK 2040	MERCEDES	Atego, Axor OM906, OM457LA	REME0204
160.	11PK 2065	MERCEDES	OM457LA	REME0205
161.	11PK 2835	MERCEDES	Actros OM501, OM502	REME0206
162.	11PK 2871	MERCEDES	Actros OM501, OM502	REME0207
163.	12PK 1300	MAN	D0826, D0834, D0836	REME0208
164.	12PK 1515	MERCEDES	Actros OM501, OM502	REME0049
165.	12PK 1962	MAN	D2840	REME0209
166.	12PK 2135	MERCEDES	Actros OM501, OM502	REME0210
167.	12PK 2500	MERCEDES	Actros OM501, OM502	REME0211
168.	14PK 1306	MAN	D2866, TGA D2876	REME0212
169.	14PK 1590	MAN	D2866, TGA D2876	REME0213
170.	14PK 1708	MAN	D2866, TGA D2876	REME0214

TURBO KOMPRESORI

Poz.	Tip vozila	OE broj	RAPIDEX broj
1.	DAF 85XF, 95XF	1319283	MOTO0950
2.	DAF 85CF, 95XF, CF85	1377426	MOTO0951
3.	DAF 95XF	1319282	MOTO0952
4.	MAN D0826, D0836	51.09100.7439	MOTO0953
5.	MAN D2566, D2866	51.09100.7086	MOTO0954
6.	MAN D2866, D2876	51.09100.7429	MOTO0955
7.	MAN D2876	51.09100.7495	MOTO0956
8.	MAN D2876	51.09100.7785	MOTO0957
9.	MERCEDES OM422LA, OM442A	003 096 55 99	MOTO0958
10.	MERCEDES OM401LA	004 096 36 99	MOTO0959
11.	MERCEDES Actros OM501	007 096 47 99	MOTO0014
12.	MERCEDES Actros OM502	008 096 16 99	MOTO0960
13.	SCANIA DSC9 12	1 501 641	MOTO0961
14.	SCANIA DSC11	1 423 029	MOTO0962
15.	SCANIA DSC12	1 375 883	MOTO0963
16.	SCANIA DSC14	1 384 862	MOTO0964
17.	VOLVO FH12, FM12(D12A, C, D)	3165219	MOTO0965
18.	VOLVO FH12 (D12A)	20728220	MOTO0966
19.	VOLVO FM12 (D13A)	20857656	MOTO0967

VISKO VENTILATORI

Poz.	Tip vozila	Dimenzija (mm)	OE broj	RAPIDEX broj
1.	DAF F95	Ø720 8p	1309501	MOTO0919
2.	DAF 95XF, XF95	Ø720 8p	1338736	MOTO0920
3.	DAF XF95	Ø720 8p	1634941	MOTO0921
4.	DAF CF85, XF95	Ø233	1654555	MOTO0922
5.	DAF CF75, 85	Ø725 8p	1448200	MOTO0923
6.	IVECO TurboStar, TurboTech	Ø660 8p	99454809	MOTO0924
7.	IVECO EuroCargo, EuroStarr, EuroTech, EuroTrakker	Ø704 8p	99479094	MOTO0925
8.	IVECO EuroTech, EuroTrakker Cursor	Ø654 8p	500342509	MOTO0926

1

VISKO VENTILATORI				
Poz.	Tip vozila	Dimenzija (mm)	OE broj	RAPIDEX broj
9.	MAN F90	Ø720 8p	51.06601.0243	MOTO0927
10.	MAN G90, M90	Ø180	51.06630.0043	MOTO0928
11.	MAN F90, F2000	Ø620 6p	51.06601.0238	MOTO0929
12.	MAN F90, F2000	Ø203	51.06630.0066	MOTO0930
13.	MAN M90, TGL	Ø186	51.06630.0067	MOTO0027
14.	MAN TGA		51.06630.0115	MOTO0518
15.	MERCEDES NG	Ø620 8p	002 205 60 06	MOTO0931
16.	MERCEDES O404	Ø720 9p	003 205 07 06	MOTO0932
17.	MERCEDES O405	Ø630 8p	002 205 66 06	MOTO0933
18.	MERCEDES SK	Ø720 8p	002 205 97 06	MOTO0934
19.	MERCEDES SK	Ø680 6p	002 205 83 06	MOTO0935
20.	MERCEDES Atego	Ø203	906 200 08 22	MOTO0936
21.	MERCEDES Actros	Ø233	000 200 72 22	MOTO0937
22.	MERCEDES Actros	Ø233	000 200 71 22	MOTO0938
23.	MERCEDES Axor	Ø233	000 200 67 22	MOTO0939
24.	MERCEDES MK, SK	Ø680 8p	003 205 16 06	MOTO0940
25.	MERCEDES Atego	Ø704 8p	906 205 04 06	MOTO0941
26.	MERCEDES Axor	Ø750 8p	003 205 36 06	MOTO0942
27.	MERCEDES Actros	Ø750 8p	003 205 31 06	MOTO0943
28.	SCANIA 114, 124	Ø750 8p	1 393 424	MOTO0944
29.	SCANIA 114, 124	Ø680 8p	1 402 869	MOTO0945
30.	VOLVO FH12, FM10, FM12	Ø680 8p	20364981	MOTO0946
31.	VOLVO FH16, FL12	Ø750 8p	1674553	MOTO0947
32..	VOLVO FH12, FH16	Ø750 8p	20517753	MOTO0948
33..	VOLVO FM9, FM12	Ø680 8p	20450239	MOTO0949

1

HLADNJACI I INTERKULERI				
Poz.	Tip vozila	Dimenzija (mm)	OE broj	RAPIDEX broj
1.	DAF 95	608 x 852 x 52	1287157	HLAD0269
2.	DAF 95 1987+1990	869 x 748 x 42	393433	HLAD0270
3.	DAF 95 1990+1998	1067 x 748 x 42	1286208	HLAD0271
4.	DAF 95XF	1067 x 748 x 42	1326966	HLAD0272
5.	DAF 95XF	554 x 852 x 52	1327673	HLAD0273
6.	DAF Bova	900 x 708 x 52	1451570	HLAD0274
7.	DAF XF95	1067 x 748 x 42	1617341	HLAD0275
8.	IVECO Daily 1996+1999	641 x 488 x 34	93825378	HLAD0276
9.	IVECO EuroCargo	570 x 560 x 33	500380655	HLAD0277
10.	IVECO EuroCargo Tector	520 x 432 x 52	500380659	HLAD0278
11.	IVECO EuroStar Cursor	900 x 748 x 42	500326345	HLAD0279
12.	IVECO EuroStar Cursor, Stralis	652 x 772 x 52	504015564	HLAD0280
13.	IVECO EuroStar, EuroTech	900 x 748 x 42	93160531	HLAD0281

1

HLADNJACI I INTERKULERI				
Poz.	Tip vozila	Dimenzija (mm)	OE broj	RAPIDEX broj
14.	IVECO Eurostar, Eurotech, Eurotrakker	650 x 712 x 52	41016520	HLAĐ0282
15.	IVECO EuroStar, EuroTrakker, Stralis	1124 x 748 x 42	41214447	HLAĐ0283
16.	IVECO EuroStar, EuroTrakker, Stralis	652 x 872 x 52	41214448	HLAĐ0284
17.	IVECO EuroTrakker 1993+2004	800 x 748 x 42	93192909	HLAĐ0285
18.	IVECO Eurotrakker Cursor, Stralis	800 x 748 x 42	41218266	HLAĐ0286
19.	IVECO Eurotrakker Cursor, Stralis	651 x 772 x 50	41218267	HLAĐ0287
20.	IVECO Stralis	900 x 748 x 42	504011119	HLAĐ0288
21.	IVECO TurboStar	489 x 792 x 50	93155694	HLAĐ0289
22.	MAN TGL 2005→	590 x 608 x 40	81.06101.6492	HLAĐ0290
23.	MAN F2000	652 x 612 x 64	81.06130.0083 81.06130.0082	HLAĐ0291
24.	MAN F2000	652 x 732 x 64	81.06130.0084	HLAĐ0292
25.	MAN F2000, III i IV	1065 x 708 x 42	81.06101.6424	HLAĐ0027
26.	MAN F2000, III i IV	945 x 708 x 42	81.06101.6437	HLAĐ0026
27.	MAN F2000, 343, 403, 463	945 x 708 x 42	81.06101.6423 81.06101.6438	HLAĐ0053
28..	MAN F2000, 463	1065 x 708 x 42	81.06101.6421 81.06101.6439	HLAĐ0292
29.	MAN F90 1986+1995, 292, 302, 322, 332, 372, 422	915 x 704 x 47	81.06101.6327	HLAĐ0056
30.	MAN TGA	920 x 938 x 42	81.06101.6459 81.06101.6512	HLAĐ0151
31.	MAN TGA	765 x 938 x 42	81.06101.6458 81.06101.6468 81.06101.6510	HLAĐ0052
32.	MAN TGA	845 x 938 x 42	81.06101.6482 81.06101.6511	HLAĐ0294
33.	MAN TGA	685 x 892 x 66	81.06130.0176	HLAĐ0295

1

HLADNJACI I INTERKULERI				
Poz.	Tip vozila	Dimenzija (mm)	OE broj	RAPIDEX broj
34.	MAN TGA	665 x 892 x 64 plastika	81.06130.0180 81.06130.0198 81.06130.0216	HLAĐ0296
35.	MAN TGA	665 x 892 x 64 aluminijum	81.06130.0199	HLAĐ0297
36.	MAN TGA	665 x 892 x 64 plastika	81.06130.0179	HLAĐ0298
37.	MAN TGL	535 x 512 x 50	81.06130.0192	HLAĐ0299
38.	MAN TGL, TGM	608 x 705 x 40	81.06101.6493	HLAĐ0300
39.	MERCEDES Actros	817 x 808 x 42	942 500 09 03	HLAĐ0301
40.	MERCEDES Actros	902 x 808 x 42	942 500 10 03	HLAĐ0034
41.	MERCEDES Actros	952 x 808 x 42	942 500 11 03	HLAĐ0009
42.	MERCEDES Actros	817 x 808 x 42	942 500 15 03	HLAĐ0302
43.	MERCEDES Actros	1051 x 808 x 42	942 500 12 03	HLAĐ0024
44.	MERCEDES Actros 1996→	752 x 652 x 50	942 501 03 01	HLAĐ0060
45.	MERCEDES Actros 1996→	752 x 852 x 66	942 501 02 01	HLAĐ0303
46.	MERCEDES Atego 1	572 x 432 x 52	656 501 00 01	HLAĐ0304
47.	MERCEDES Atego 1	572 x 512 x 64	970 501 02 01	HLAĐ0305
48.	MERCEDES Atego 2	596 x 712 x 64	940 501 02 01	HLAĐ0306
49.	MERCEDES Atego 715, 815, 1215	570 x 560 x 33	970 500 05 03	HLAĐ0062
50.	MERCEDES Atego 917, 818, 1017, 1217, 1317, 1517, 1523	570 x 558 x 42	970 500 04 03	HLAĐ0307
51.	MERCEDES Atego 2	815 x 668 x 42	940 500 03 03	HLAĐ0059
52.	MERCEDES Axor	974 x 668 x 42	940 500 07 03	HLAĐ0006
53.	MERCEDES NG 1635, 1644, 1935, 2035, 2235, 2635	740 x 660 x 50	001 501 37 01	HLAĐ0308
54.	MERCEDES O405 1984→	590 x 672 x 62	000 500 01 03	HLAĐ0309

HLADNJACI I INTERKULERI

Poz.	Tip vozila	Dimenzija (mm)	OE broj	RAPIDEX broj
55.	MERCEDES SK 1987→, 1735, 1935, 2635, 3235, 3535, 4844	730 x 638 x 42	652 501 45 01	HLAĐ0310
56.	MERCEDES SK 1987→, 1735, 1935, 2635, 3235, 3535	662 x 645 x 47	655 500 00 03	HLAĐ0311
57.	MERCEDES SK 1987→, 1748, 1844, 2044, 2448, 3248	823 x 802 x 47	655 500 30 03	HLAĐ0312
58.	MERCEDES Sprinter 2t, 3t	680 x 400 x 33	901 500 31 00	HLAĐ0313
59.	MERCEDES Sprinter 2t, 3t, 4t	680 x 406 x 42	901 500 36 00	HLAĐ0314
60.	MERCEDES Sprinter 2t, 3t, 4t	680 x 400 x 33	901 500 35 00	HLAĐ0315
61.	MERCEDES Sprinter 3t	633 x 232 x 50	901 501 10 01	HLAĐ0316
62.	MERCEDES Travego	1065 x 708 x 52	000 501 06 01	HLAĐ0317
63.	MERCEDES Travego	1015 x 808 x 42	002 501 01 01	HLAĐ0318
64.	MERCEDES Travego 1999→	931 x 732 x 66	000 500 00 02	HLAĐ0319
65.	SCANIA Serija 2, 112	970 x 760 x 60	310081, 334841, 570452	HLAĐ0320
66.	SCANIA Serija 2, 3, 112, 142, 113, 143	672 x 650 x 52	352304	HLAĐ0321
67.	SCANIA Serija 2, 3, 82, 92, 112, 93, 113	715 x 737 x 52	310080, 334840, 570453	HLAĐ0322
68.	SCANIA Serija 3, 143	715 x 1030 x 52	310082, 321888, 334842, 570451	HLAĐ0029
69.	SCANIA Serija 4, 114, 124, 144	860 x 938 x 42	1 327 249, 1 408 881, 1 442 751	HLAĐ0028
70.	SCANIA Serija 4, 124, 144	828 x 792 x 66	570472	HLAĐ0323
71.	SCANIA Serija P, R, T 2005→	828 x 792 x 66	1 547 316, 1 747 660, 1 795 730	HLAĐ0324
72.	VOLVO F10, F12	790 x 820 x 73	0475701, 16645004	HLAĐ0325
73.	VOLVO FH12	885 x 775 x 62	1665242, 8112564	HLAĐ0326
74.	VOLVO FH12, FH16	900 x 900 x 50	1676435, 1676635, 8113190	HLAĐ0327
75.	VOLVO FH12, FM7, FM12, 1993→	730 x 900 x 50	1665249, 1665349, 1676636	HLAĐ0328

EKSPANZIONE POSUDE I ULJNI HLADNJACI

Poz.	Tip vozila	Dimenzija (mm)	OE broj	RAPIDEX broj
1.	DAF 95XF, XF95	547 x 337 x 104	1295910	HLAĐ0400
2.	IVECO TurboStar	520 x 104 x 32	93155695	HLAĐ0401
3.	IVECO EuroCargo, TurboStar	490 x 140 x 223 10,6 l	42041318	HLAĐ0402
4.	IVECO EuroStar, EuroTech, EuroTrakker	270 x 165 x 192 5,3 l	8166285	HLAĐ0403
5.	IVECO EuroStar, EuroTech, EuroTrakker	306 x 170 x 416 8,0 l	8168290	HLAĐ0404
6.	IVECO Stralis, Trakker	589 x 460 x 180	41215631	HLAĐ0043
7.	MAN L2000	160 x 78 x 60	51.05601.0107	MOTO0913
8.	MAN F90, F2000, TGA	250 x 78 x 63	51.05601.0121	MOTO0163
9.	MAN F90, F2000, TGA	250 x 78 x 63	51.05601.0148	MOTO0168
10.	MAN F90	742 x 321 x 130 14,1 l	81.06102.6098	HLAĐ0002
11.	MAN M2000, L2000 1995→	742 x 321 x 130 5,6 l	81.06102.6100	HLAĐ0405
12.	MAN F2000	743 x 321 x 108	81.06102.6110	HLAĐ0150

EKSPANZIONE POSUDE I ULJNI HLADNJACI				
Poz.	Tip vozila	Dimenzija (mm)	OE broj	RAPIDEX broj
13.	MAN F2000	743 x 321 x 242	81.06102.6117	HLAĐ0406
14.	MERCEDES MK, NG, O303, O405, O407, SK	250 x 78 x 63	001 188 31 01	MOTO0914
15.	MERCEDES NG, O303, SK	250 x 78 x 63	422 188 00 01	MOTO0915
16.	MERCEDES NG, O303, SK	250 x 78 x 61	422 188 01 01	MOTO0916
17.	MERCEDES MK, NG, SK, O303, O404	250 x 78 x 63	001 188 88 01	MOTO0917
18.	MERCEDES LP, NG	460 x 74 x 270 6,4 l	381 500 08 49	HLAĐ0407
19.	MERCEDES MK, NG, SK	440 x 310 x 50 11,8 l	000 500 22 49	HLAĐ0408
20.	MERCEDES MK, NG, SK, Unimog	552 x 455 x 22 11,8 l	000 500 21 49	HLAĐ0409
21.	MERCEDES Actros 1996+2003	566 x 289 x 444 12,2 l	000 500 30 49	HLAĐ0030
22.	MERCEDES Actros 1996+2003	566 x 289 x 444 12,2 l	000 500 31 49	HLAĐ0031
23.	SCANIA 114 C, G, L	444 x 233 x 279 10,5 l	1 370 707	HLAĐ0410
24.	VOLVO B10	300 x 100 x 32	469698	MOTO0918



IZMENJIVAČI TOPLOTE				
Poz.	Tip vozila	Dimenzija (mm)	OE broj	RAPIDEX broj
1.	DAF 65CF, 75CF, 85CF, XF95, CF65, CF75, CF85	372 x 189 x 42	1454123	HLAĐ0247
2.	DAF 95XF	370 x 189 x 42	1335401	HLAĐ0248
3.	IVECO EuroCargo 1991→	295 x 175 x 42	98418409	HLAĐ0249
4.	MAN F2000, M2000	370 x 189 x 42	81.61901.0067	HLAĐ0250
5.	MAN F90 1986+1997	370 x 189 x 42	81.61901.0056	HLAĐ0152
6.	MAN G90 1987+1995	302 x 189 x 42	81.61920.6023	HLAĐ0251
7.	MAN L2000, M2000	370 x 189 x 42	81.61901.0065	HLAĐ0070
8.	MAN TGA 2000→	370 x 189 x 42	81.61901.6166	HLAĐ0130
9.	MERCEDES Actros 2003→	370 x 175 x 32	000 830 07 20	HLAĐ0252
10.	MERCEDES Actros 1996→	390 x 226 x 40	003 835 11 01	HLAĐ0253
11.	MERCEDES Atego, Axor	355 x 830 x 285	001 830 19 03	HLAĐ0254
12.	MERCEDES LK 711, 811, 814	420 x 552 x 52	673 501 01 01	HLAĐ0255
13.	MERCEDES MK 1988+1994, SK 1988+1994	390 x 226 x 40	002 835 68 01	HLAĐ0257

IZMENJIVAČI TOPLOTE

Poz.	Tip vozila	Dimenzija (mm)	OE broj	RAPIDEX broj
14.	MERCEDES NG 1973÷1991, SK 1989÷1994	360 x 171 x 48	002 835 09 01	HLAĐ0256
15.	MERCEDES NG, LP 709, 808, 809	320 x 171 x 42	001 835 92 01	HLAĐ0258
16.	MERCEDES O303, O305	372 x 229 x 40	002 835 00 01	HLAĐ0259
17.	MERCEDES O405	370 x 189 x 42	003 835 30 01	HLAĐ0260
18.	MERCEDES SK	398 x 784 x 50	655 501 00 01	HLAĐ0261
19.	MERCEDES Sprinter 1995÷2006	152 x 170 x 40	003 835 35 01	HLAĐ0262
20.	MERCEDES Unimog	468 x 432 x 50	437 501 05 01	HLAĐ0263
21.	SCANIA 104, 114, 124, 144, 1998→	453 x 157 x 32	1 437 263	HLAĐ0264
22.	SCANIA 113, 143, 1988÷1996	295 x 230 x 49	1 331 928	HLAĐ0265
23.	VOLVO F10, F12, F16	370 x 189 x 42	1 587 964	HLAĐ0266
24.	VOLVO FH12, FH16, FM7, FM12	370 x 189 x 40	3090893	HLAĐ0134
25.	VOLVO FL6	370 x 189 x 42	1697358	HLAĐ0267
26.	VOLVO FL7, FL10	370 x 189 x 42	1624373	HLAĐ0268

GREJAČI KABINE











Poz.	Naziv dela	Tip vozila	OE broj	RAPIDEX broj
1.	VENTILATOR GREJAČA KOMPLET	DAF 65-85CF, 95XF, XF95	1331270	ELEK0756
2.	VENTILATOR GREJAČA KOMPLET	MAN TGA	81.61930.6064	ELEK0757
3.	MOTOR GREJAČA	MAN F90, L2000, M2000	81.61930.0042	ELEK0761
4.	MOTOR GREJAČA	MAN F90, L2000, F2000	81.61930.6042	ELEK0762
5.	VENTILATOR GREJAČA KOMPLET	MERCEDES ATEGO1, ATEGO2	002 830 24 08	ELEK0758
6.	VENTILATOR GREJAČA KOMPLET	MERCEDES ACTROS	001 830 87 08	ELEK0759
7.	VENTILATOR GREJAČA KOMPLET	MERCEDES MK, NG, SK	000 830 86 08	ELEK0760
8.	MOTOR GREJAČA	MERCEDES MK, NG, SK	001 830 03 08	ELEK0763
9.	MOTOR GREJAČA	MERCEDES ATEGO1, ATEGO2	002 830 24 08	ELEK0758
10.	VENTILATOR GREJAČA KOMPLET	VOLVO FM	20443822	ELEK0764
11.	VENTILATOR GREJAČA KOMPLET	VOLVO FH12, FH16, FM7, FM12	3090905	ELEK0765











KONDENZATORI I ISPARIVAČI KLIME				
Poz.	Tip vozila	Dimenzija (mm)	OE broj	RAPIDEX broj
1.	DAF 95 1987÷1996	500 x 537 x 16	1287796	HLAĐ0356
2.	DAF 95XF 1997÷2002	470 x 610 x 22	1387308	HLAĐ0357
3.	DAF 95XF 1997÷2002	500 x 537 x 16	1321833	HLAĐ0359
4.	DAF XF95, XF105 2005 →	500 x 537 x 16	1629115	HLAĐ0360
5.	IVECO Daily 2 1999 →	680 x 310 x 19	99487944	HLAĐ0361
6.	IVECO EuroStar, EuroTech, EuroTrakker	483 x 580 x 33	8189330	HLAĐ0363
7.	IVECO Stralis 2002 →	478 x 424 x 20	533770202	HLAĐ0362
8.	MAN M90 1988÷1996, M2000 1995 →	652 x 286 x 48	81.61920.6019	HLAĐ0364
9.	MAN F90	682 x 260 x 48	81.61920.6011	HLAĐ0365
10.	MAN L2000 1993 →	596 x 247 x 48	81.61920.0011	HLAĐ0366
11.	MAN F2000 1994 →	678 x 305 x 33	81.61920.0012	HLAĐ0367
12.	MAN TGA 2000 →	750 x 351 x 16	81.61920.0018	HLAĐ0368
13.	MAN F90, M90, F2000, M2000	360 x 208 x 64	81.61920.6027	HLAĐ0369
14.	MAN L2000	360 x 208 x 64	81.61920.0013	HLAĐ0370
15.	MAN TGA	385 x 203 x 67	81.61920.6032	HLAĐ0371
16.	MERCEDES Sprinter 1995÷1906	670 x 380 x 18	901 500 04 54	HLAĐ0372
17.	MERCEDES NG, SK	784 x 312 x 32	645 500 00 54	HLAĐ0373
18.	MERCEDES SK	470 x 610 x 22	000 500 11 54	HLAĐ0374
19.	MERCEDES NG, SK 1988÷1996	470 x 610 x 22	000 500 12 54	HLAĐ0375
20.	MERCEDES Vario 1996 →	500 x 537 x 16	668 500 02 54	HLAĐ0376
21.	MERCEDES Atego 1998 →	500 x 537 x 16	970 500 00 54	HLAĐ0377
22.	MERCEDES Axor 2002 →	600 x 457 x 22	940 500 02 54	HLAĐ0378
23.	MERCEDES Actros	673 x 457 x 22	942 500 00 54	HLAĐ0379
24.	MERCEDES Vario 813, 814, 815, 816	206 x 182 x 64	670 830 03 58	HLAĐ0380
25.	MERCEDES MK, SK	348 x 208 x 64	000 830 58 58	HLAĐ0381











KONDENZATORI I ISPARIVAČI KLIME				
Poz.	Tip vozila	Dimenzija (mm)	OE broj	RAPIDEX broj
26.	MERCEDES Atego, Actros		000 830 17 83	HLAĐ0033
27.	MERCEDES Actros, Actros MP2		000 830 24 83	HLAĐ0413
28.	MERCEDES Actros 1996 →	385 x 203 x 67	000 830 83 58	HLAĐ0382
29.	MERCEDES Actros 2003 →	200 x 307 x 65	001 830 49 58	HLAĐ0383
30.	SCANIA 142 R/T 1981÷1996	605 x 525 x 20	1 335 417	HLAĐ0384
31.	SCANIA 94, 114, 124, 144, 164	820 x 453 x 26	1 449 779	HLAĐ0385
32.	SCANIA 94, 114, 124, 144, 164	820 x 453 x 26	1 354 110	HLAĐ0386
33.	VOLVO FL6 1985÷1998	400 x 546 x 32	3 121 351	HLAĐ0387
34.	VOLVO FH12 1993÷1995 FL10 1995 →	842 x 359 x 24	8144689	HLAĐ0388
35.	VOLVO FH12 1997÷2001, FH16 1997÷2001	684 x 352 x 26	3962651	HLAĐ0389
36.	VOLVO FH12 1998 →, FH16 1998 →	836 x 344 x 18	3980841	HLAĐ0390
37.	VOLVO FH12 1997÷2001, FH16 1997÷2001	684 x 352 x 26	3962652	HLAĐ0391
38.	VOLVO FH16 1993÷1997	683 x 359 x 24	8144690	HLAĐ0392
39.	VOLVO FH16 1995 →, FM10 1999 →, FM12 1998 →, FM7 1998 →	517 x 344 x 18	3981637	HLAĐ0393
40.	VOLVO FL6 1985÷1994	349 x 208 x 64	8150492	HLAĐ0394
41.	VOLVO FH12 1993 →, FH16 1993 →, FM7 1998 →, FM10 1999 →, FM12	359 x 229 x 67	3090880	HLAĐ0395
42.	VOLVO FH12 2002 →, FM9 2002 →, FM12 2002 →	235 x 306 x 65	20443846	HLAĐ0396



CREVA VODE					
Slika	Poz.	Tip vozila	Dimenzije (mm)	OE broj	RAPIDEX broj
	1.	DAF XF95	30 x 30 x 530	1347468	HLAĐ0086
	2.	DAF XF95	60 x 60 x 400	1353922	HLAĐ0087
	3.	DAF XF95	60 x 70 x 400	1293809	HLAĐ0088
	4.	DAF 95XF	60 x 60 x 440	1338931	HLAĐ0187
	5.	DAF 95XF	60 x 60 x 620	1297739	HLAĐ0188
	6.	DAF 95XF	31 x 42 x 440	1290141	HLAĐ0189
	7.	DAF 95XF	22 x 26 x 410	1293808	HLAĐ0190
	8.	DAF CF85	60 x 60 x 1250	1371353	HLAĐ0191
	9.	DAF CF85	60 x 60 x 345	1372303	HLAĐ0192
	10.	DAF CF85	25 x 34 x 460	1355106	HLAĐ0193
	11.	DAF CF	60 x 60 x 530	1440636	HLAĐ0194

CREVA VODE					
Slika	Poz.	Tip vozila	Dimenzije (mm)	OE broj	RAPIDEX broj
	12.	IVECO EuroTech, EuroTrakker	58 x 58 x 475	8164343	HLAĐ0195
	13.	IVECO EuroTech, EuroStar	58 x 58 x 830	8161344	HLAĐ0196
	14.	IVECO EuroTrakker	60 x 60 x 1000	8161345	HLAĐ0197
	15.	IVECO Stralis	55 x 57 x 720	41218703	HLAĐ0105
	16.	IVECO Stralis	55 x 57 x 525	41218702	HLAĐ0106
	17.	IVECO EuroCargo, EuroBus	40 x 44 x 545	500339054	HLAĐ0198
	18.	IVECO EuroCargo, EuroBus	44 x 44 x 490	500339052	HLAĐ0199
	19.	MAN TGA	60 x 60 x 430	81.96301.0677	HLAĐ0082
	20.	MAN NG, SG, SL, SR, SG	22 x 22 x 880	81.96305.0166	HLAĐ0200
	21.	MAN TGA	60 x 60 x 620	81.96301.0898	HLAĐ0083
	22.	MAN TGA	18 x 18 x 380	81.96305.0300	HLAĐ0094











CREVA VODE					
Slika	Poz.	Tip vozila	Dimenzije (mm)	OE broj	RAPIDEX broj
	23.	MAN TGA	18 x 18 x 630	81.96305.0217	HLAĐ0102
	24.	MAN TGA	18 x 18 x 520	81.96305.0262	HLAĐ0103
	25.	MAN TGA	18 x 18 x 510	81.96305.0272	HLAĐ0104
	26.	MAN TGL	18 x 18 x 960	81.96305.0304	HLAĐ0109
	27.	MAN TGL	50 x 50 x 565	81.96301.0904	HLAĐ0110
	28.	MAN TGL	50 x 50 x 485	81.96301.0906	HLAĐ0111
	29.	MAN TGA, TGL, TGM	18 x 18 x 460	81.96301.0895	HLAĐ0112
	30.	MAN TGA, TGL, TGM	18 x 18 x 18	81.96301.0896	HLAĐ0046
	31.	MAN TGA, TGL, TGM	18 x 18 x 280	81.96301.0894	HLAĐ0113
	32.	MAN F2000	60 x 60 x 460	81.96301.0659	HLAĐ0114
	33.	MAN F2000	60 x 60 x 615	81.96305.0088	HLAĐ0201

CREVA VODE					
Slika	Poz.	Tip vozila	Dimenzije (mm)	OE broj	RAPIDEX broj
	34.	MAN F2000	60 x 60 x 630	81.96305.0129	HLAĐ0115
	35.	MAN F2000	18 x 18 x 330	81.96305.0192	HLAĐ0116
	36.	MAN TGA	18 x 18 x 170	81.96305.0194	HLAĐ0118
	37.	MAN TGA	18 x 18 x 200	81.96305.0193	HLAĐ0119
	38.	MAN TGA	18 x 18 x 550	81.96305.0197	HLAĐ0120
	39.	MERCEDES Actros	65 x 65 x 740	941 501 03 82	HLAĐ0022
	40.	MERCEDES Actros	19 x 19 x 450	940 506 12 35	HLAĐ0084
	41.	MERCEDES Actros	20 x 22 x 340	940 506 18 35	HLAĐ0085
	42.	MERCEDES Actros	28 x 28 x 280	940 528 12 82	MOTO0159
	43.	MERCEDES Actros	63 x 63 x 240	941 501 05 82	HLAĐ0021
	44.	MERCEDES Travego	60 x 65 x 190	001 501 22 82	HLAĐ0202











CREVA VODE					
Slika	Poz.	Tip vozila	Dimenzije (mm)	OE broj	RAPIDEX broj
	45.	MERCEDES Travego	70 x 70 x 180	000 501 58 82	HLAĐ0203
	46.	MERCEDES Travego	37 x 37 x 100	000 501 54 82	HLAĐ0204
	47.	MERCEDES Travego	50 x 50 x 100	000 501 55 82	HLAĐ0205
	48.	MERCEDES Actros	28 x 28 x 335	942 501 06 82	HLAĐ0020
	49.	MERCEDES Actros	22 x 22 x 250	942 506 31 35	HLAĐ0019
	50.	MERCEDES Sprinter	65 x 65 x 820	901 528 47 82	HLAĐ0206
	51.	MERCEDES Sprinter	50 x 60 x 380	901 528 43 82	HLAĐ0207
	52.	MERCEDES Sprinter	42 x 42 x 290	901 501 18 82	HLAĐ0208
	53.	MERCEDES Sprinter	42 x 42 x 380	901 501 11 82	HLAĐ0209
	54.	MERCEDES Sprinter	65 x 65 x 610	901 528 22 82	HLAĐ0210
	55.	MERCEDES Sprinter	50 x 65 x 620	901 528 18 82	HLAĐ0211

CREVA VODE					
Slika	Poz.	Tip vozila	Dimenzije (mm)	OE broj	RAPIDEX broj
	56.	MERCEDES Sprinter	42 x 42 x 440	901 501 15 82	HLAĐ0212
	57.	MERCEDES Actros	22 x 22 x 450	942 466 02 81	HLAĐ0018
	58.	MERCEDES Actros	18 x 18 x 285	942 506 41 35	HLAĐ0068
	59.	MERCEDES Actros	10 x 10 x 340	942 506 10 35	HLAĐ0069
	60.	MERCEDES Actros	18 x 22 x 585	942 506 36 35	HLAĐ0095
	61.	MERCEDES Axor	32 x 35 x 490	940 528 08 82	HLAĐ0213
	62.	MERCEDES Axor	28 x 28 x 220	940 501 12 82	HLAĐ0214
	63.	MERCEDES Axor	60 x 70 x 480	940 501 15 82	HLAĐ0215
	64.	MERCEDES Axor	18 x 18 x 590	940 506 17 35	HLAĐ0216
	65.	MERCEDES Axor	60 x 60 x 265	940 501 14 82	HLAĐ0217
	66.	MERCEDES Axor	12 x 12 x 200	940 501 16 82	HLAĐ0218

1

CREVA VODE					
Slika	Poz.	Tip vozila	Dimenzije (mm)	OE broj	RAPIDEX broj
	67.	MERCEDES Axor	12 x 12 x 500	940 501 17 82	HLAĐ0219
	68.	MERCEDES Axor	18 x 20 x 560	940 506 16 35	HLAĐ0220
	69.	MERCEDES Axor	18 x 20 x 410	940 506 13 35	HLAĐ0221
	70.	MERCEDES Axor	50 x 50 x 560	940 501 09 82	HLAĐ0222
	71.	MERCEDES Axor	28 x 28 x 380	940 501 18 82	HLAĐ0223
	72.	MERCEDES Axor	38 x 38 x 330	620 528 02 82	HLAĐ0224
	73.	MERCEDES Atego	50 x 50 x 680	970 501 00 82	HLAĐ0096
	74.	MERCEDES Atego	21 x 21 x 400	970 501 08 82	HLAĐ0097
	75.	MERCEDES Atego	21 x 29 x 820	970 501 02 82	HLAĐ0098
	76.	MERCEDES Atego	22 x 28 x 520	973 501 02 82	HLAĐ0099
	77.	RENAULT Premium	48 x 48 x 26 x 530	5010514577	HLAĐ0225

1

CREVA VODE					
Slika	Poz.	Tip vozila	Dimenzije (mm)	OE broj	RAPIDEX broj
	78.	RENAULT Premium	48 x 53 x 510	5010514144	HLAĐ0226
	79.	RENAULT Premium	16 x 19 x 295	5010304545	HLAĐ0227
	80.	RENAULT Magnum	50 x 58 x 1040	5010315046	HLAĐ0228
	81.	RENAULT Magnum	49 x 54 x 525	5010514182	HLAĐ0229
	82.	RENAULT Magnum	49 x 49 x 970	5010514472	HLAĐ0230
	83.	RENAULT Magnum	49 x 58 x 455	5010315936	HLAĐ0231
	84.	RENAULT Premium	53 x 53 x 240	5010467589	HLAĐ0232
	85.	RENAULT Magnum DXI	49 x 59 x 490	7420780845	HLAĐ0233
	86.	RENAULT Magnum DXI	49 x 59 x 415	7420710486	HLAĐ0234
	87.	RENAULT Magnum DXI	70 x 63 x 445 x 340	5010228348	HLAĐ0235
	88.	SCANIA CR114, CR124	54 x 54 x 640	1 529 007	HLAĐ0101

CREVA VODE					
Slika	Poz.	Tip vozila	Dimenzije (mm)	OE broj	RAPIDEX broj
	89.	SCANIA CR164	10 x 10 x 540	1 376 895	HLAĐ0236
	90.	SCANIA CR164	10 x 10 x 685	1 376 896	HLAĐ0237
	91.	SCANIA CP DSC11, 75/79	55 x 55 x 410	1 385 086	HLAĐ0238
	92.	SCANIA CP DSC11, 75/79	55 x 55 x 420	1 395 066	HLAĐ0239
	93.	SCANIA CR144, CR164	55 x 55 x 580	1 449 431	HLAĐ0091
	94.	SCANIA CR144, GRS900R	56 x 56 x 440	1 377 231	HLAĐ0092
	95.	SCANIA CR144, CR164	31 x 34 x 410	1 426 194	HLAĐ0093
	96.	VOLVO FH12	20 x 20 x 310	3154395	HLAĐ0240
	97.	VOLVO FH12	20 x 20 x 340	3154396	HLAĐ0160
	98.	VOLVO FH12	60 x 60 x 480	1665951	HLAĐ0089
	99.	VOLVO FH12	65 x 65 x 520	1665940	HLAĐ0090

CREVA VODE					
Slika	Poz.	Tip vozila	Dimenzije (mm)	OE broj	RAPIDEX broj
	100.	VOLVO FH12	12 x 12 x 80	20367063	KOCN0369
	101.	VOLVO FH12, FM12	13 x 13 x 150	20456429	HLAĐ0241
	102.	VOLVO FH12	21 x 21 x 340	20544321	HIDR0049
	103.	VOLVO FH12	20 x 20 x 890	20453672	HLAĐ0100
	104.	VOLVO FH16	58 x 61 x 440	20968736	HLAĐ0242
	105.	VOLVO FH12, FM12	58 x 63 x 520	20542199	HLAĐ0107
	106.	VOLVO FL12	55 x 59 x 320	1544845	HLAĐ0243
	107.	VOLVO FH16	58 x 61 x 440	20968744	HLAĐ0244
	108.	VOLVO FM10	50 x 61 x 625	3183616	HLAĐ0245
	109.	VOLVO FH16	27 x 31 x 400	1674928	HLAĐ0246

1

CREVA INTERKULERA					
Slika	Poz.	Tip vozila	Dimenzija (mm)	OE broj	RAPIDEX broj
	1.	DAF	100 x 130	1286075	HLAĐ0329
	2.	DAF F85, F95, 95XF	101 x 117	1204236	HLAĐ0330
	3.	DAF 95XF, XF95	100 x 400	1378391	HLAĐ0331
	4.	DAF CF75, CF85, XF95, XF105	50 x 55 x 110	1650940	HLAĐ0332
	5.	DAF CF75, CF85, XF95, XF105	50 x 60 x 30 x 120	1149578	HLAĐ0333
	6.	IVECO EuroTrakker	90 x 170	42088621	HLAĐ0334
	7.	IVECO EuroTrakker, EuroTech	90 x 190	41026109	HLAĐ0335
	8.	IVECO EuroTech	90 x 130 x 130	8134300	HLAĐ0336
	9.	IVECO EuroTech	90 x 140	10900550	HLAĐ0337
	10.	MAN F90, F2000, TGA, TGS, TGX	90 x 290	81.96301.0668 81.96301.0900	MOTO0388
	11.	MAN F90, NG, RH	100 x 230	81.96301.0587	MOTO0389

1

CREVA INTERKULERA					
Slika	Poz.	Tip vozila	Dimenzija (mm)	OE broj	RAPIDEX broj
	12.	MAN M90, L/M2000, SL/SG	65 x 190	81.96320.0175	HLAĐ0338
	13.	MAN L/M2000, SL/SG	50 x 65 x 185	81.96320.0168	HLAĐ0339
	14.	MERCEDES Atego, Bus	85 x 200	000 501 00 82	HLAĐ0340
	15.	MERCEDES Atego, Bus	83 x 200	000 501 60 82	HLAĐ0341
	16.	MERCEDES NG, SK	100 x 250	001 094 78 82	HLAĐ0342
	17.	MERCEDES MK, SK, O405	100 x 250	002 094 52 82	HLAĐ0154
	18.	MERCEDES SK, Actros	100 x 205	002 094 54 82	HLAĐ0343
	19.	MERCEDES Actros, MP2	115 x 210	002 094 66 82	MOTO0391
	20.	NEOPLAN	100 x 150	224 997 07 82	HLAĐ0344
	21.	RENAULT Premium, Magnum	90 x 255	5010315483	HLAĐ0345
	22.	RENAULT Premium, Magnum	79 x 325	5010514310	HLAĐ0346

1

CREVA INTERKULERA					
Slika	Poz.	Tip vozila	Dimenzija (mm)	OE broj	RAPIDEX broj
	23.	RENAULT Premium, Magnum	76 x 100	5010211836	HLA0347
	24.	SCANIA Serija 4	100 x 182	1 358 202 1 442 579	HLA0348
	25.	SCANIA Serija 4	90 x 140	488368	HLA0349
	26.	SCANIA Serija 4	100 x 182	10402050	HLA0350
	27.	SETRA	100 x 400	4.741.291.400	HLA0351
	28.	SETRA	50 x 65 x 65	41400250	HLA0352
	29.	VOLVO F12, FL	76 x 245	1676744 1675097	HLA0353
	30.	VOLVO FH12, FH16, FM9, FM12	100 x 148	20463924 20561450	HLA0354
	31.	VOLVO FH12, FH16, FM	80 x 390	8149800 1665556	HLA0161
	32.	VOLVO FH12, FH16, FM	76 x 148	20589122	HLA0355

1



AUTOBUSI							
Poz.	Hengst broj	Knecht/Mahle broj	Mann broj	Dimenzije (mm)	Tip vozila	OE broj	RAPIDEX broj
1.	E116L	LX227	C23440/1	228 x 116 x 10,5 x 381	Neoplan Jetliner N208	0203.154.00	FILT0224
2.	E117L	LX271	C24650/1	243 x 132 x 496	Setra O303, 405, 407, 408	8319086094	FILT0324
3.	E118L	LX273	C301537	302 x 191 x 10,5 x 473	Setra 315 GT-HD, 313UL, 315H, HD, Neoplan Centroliner, Transliner	8.319.095.138 0203.170.00	FILT0323
4.	E213L	LX299	C30630	302 x 191 x 10,5 x 338	Ikarus 260, 266, 280		FILT0376
5.	E214L	LX655	C25860	243 x 132 x 10,5 x 376	SB220		FILT0300
6.	E272L	LX674	C331840	327 x 191 x 10,5 x 479	Setra S200, S300, S312HD, S317GT	8.319.143.188.0	FILT0352
7.	E10H02		H601/4	58 x 18,5 x 100	Setra SG180, Neoplan Centroliner, Skyliner	8.225.000.232.0	FILT0214
8.	E10KPD10	KX36	P811X	83 x 13,8 x 145	IK 200, 400, 600, Neoplan Jetliner, Transliner	8.319.126.161.0	FILT0245
9.	E13HD47	OX146D	HU1381X	121 x 56 x 148	Neoplan Centroliner	8.319.080.018.0	FILT0322
10.	E161HD28	OX155D	HU947/2X	83 x 37 x 212,5	Setra, Topclass	8.311.900.044.0	FILT0003

1

AUTOBUSI							
Poz.	Hengst broj	Knecht/ Mahle broj	Mann broj	Dimenzije (mm)	Tip vozila	OE broj	RAPIDEX broj
11.	E197HD23	OX137/D1	HU947/1Z-2	83 x 21 x 199	MB Turismo, Neoplan	8.311.907.042.0	FILT0198
12.	E500KP02D36	KX80D	PU999/1X	106 x 46 x 202,5	MB Citaro, Conecto, Tourismo, Travego, Setra	541 092 09 05	FILT0228
13.	E500HD37	OX168D	HU12140X	121 x 54 x 311,50	MB Travego, Setra	541 180 02 09	FILT0237
14.	E52KPD36	KX67/2D	PU1046X	91,8 x 44,9 x 102,7	MB Tourino, Citaro, Conecto, Neoplan	8.312.088.015.0	FILT0316
15.	E251HD11	OX69D	H12110/2X	120 x 56 x 270	MB, MAN, Neoplan	8.311.999.136.0	FILT0227
16.	E161H01D28	OX155D	HU947/2X	83 x 37 x 212,50	MB, MAN, Setra	93.21525-0017	FILT0244
17.	E56KPD72	KX73/1D	PU855X	76 x 27,5 x 229	MAN Lions star	51.12503.0037	FILT0314

DAF							
Poz.	Hengst broj	Knecht/ Mahle broj	Mann broj	Dimenzije (mm)	Tip vozila	OE broj	RAPIDEX broj
1.	E115L	LX265	C20325/3	198 x 103 x 9 x 376	F1700-3600, F95, N2800	265045	FILT0075
2.	E116L	LX227	C23440/1	228 x 116 x 10,5 x 381	F2100-2500, SB3000	112294	FILT0224
3.	E117L	LX271	C24650/1	243 x 132 x 10,5 x 496	F2100-2800, SB3000	607179	FILT0324
4.	E118L	LX273	C301537	302 x 191 x 10,5 x 473	80.330 AT1	694218	FILT0323
5.	E218L	LX531	C30703	302 x 191 x 10,5 x 381	F2900-F3200, F85, F95	667078	FILT0058
6.	E214L	LX655	C25860	243 x 132 x 10,5 x 376	SB220	393561	FILT0300
7.	E313L		C291410	281,5 x 147,5 x 525	95 XF	1295090	FILT0239
8.	E366L	LX1025	C291366	281,5 x 147,5 x 507	85CF, 95XF, XF95	1664524	FILT0288
9.	H18WDK03	KC178	WDK925	93 x M22 x 1,5 x 144	95XF, XF250/280/315M	134335	FILT0233
10.	E70KPD98			89 x 46 x 18 x 247,6	XF95, CF85	1450184	FILT0271
11.	H7090WK30			108 x 1-14UNS x 157	85CF, 95XF, CF85, F1800	1296851	FILT0210
12.	H710WK		PL420x	108 x 1-14UNS x 230	XF105, XF95, CF85, CF75	1433649	FILT0306
13.	Z13D94	OZ3	ZR904x	97,8 x 12,5 x 10 x 119	CF75, PE183/228/265C	1376481	FILT0202
14.	Z12D64		ZR903x	97,8 x 14,5 x 14,5 x 119	85CF, 95XF, CF83, XF95	1310891	FILT0247
15.	T200W			139 x M41 x 1,5 x 134	XF105, XF95, CF85, CF75	1391510	FILT0305
16.	E969LI	LA71	CU2534	260 x 164 x 38	CF65, CF75, CF85	1362124	FILT0264
17.	E2927LI			227 x 107 x 20	LF45, LF55	1600428	FILT0197

1

DAF							
Poz.	Hengst broj	Knecht/ Mahle broj	Mann broj	Dimenzije (mm)	Tip vozila	OE broj	RAPIDEX broj
18.	E944LI	LA50	CU3132	324 x 238 x 23,5	95XF	1658991	FILT0221
19.	E10H02		H601/4	58 x 18,5 x 18,5 x 100	85CF, 95XF, CF85, XF95	229348	FILT0214
20.	H300W01	OC234	W13145/3	136 x 100 x 1 1/2-16UN x 308	85, 95, F2900, F3200	267714	FILT0140
21.	H19W10			93,5 x 62 x M27 x 2 x 174	LF45, LF55	1399494	FILT0354
22.	H300W02	OC289	W13145/6		85CF 1998-2000 95XF 1997-2002		FILT0311
23.	H300W03	OC482		118,5 x 2 1/4 x 12U x 289,50	XF95	1288430	FILT0203
24.	E66KPD36		PU999/2x	92 x 46 x 201	CF75, CF85, XF95	1784782	FILT0274
25.	E43HD97			109 x 69 x 220	XF95, CF85, CF75		FILT0222
26.	E89HD97		HU12103X	113 x 56 x 220	XF105	1629393	FILT0269
27.	E82KPD36		PU966/1X	104 x 46 x 249,5	XF105	1699168	FILT0211

IVECO							
Poz.	Hengst broj	Knecht/ Mahle broj	Mann broj	Dimenzije (mm)	Tip vozila	OE broj	RAPIDEX broj
1.	E434L	LX1142	C17337	163 x 94 x 353	Daily IV	99478393	FILT0082
2.	E218L	LX531	C30703	302 x 191 x 381	370S12,12.30,12.35	8122408	FILT0058
3.	E118L	LX273	C301537	302 x 191 x 473	TurboTech, TurboStar, EuroTech, EuroTrakker, EuroStar, Stralis	1904550	FILT0323
4.	E116L	LX227	C23440/1	228 x 116 x 381	80-160, EuroCargo 135E23	1902465	FILT0224
5.	E115L	LX265	C20235/3	198 x 103 x 376	EuroCargo 80E15-135E18	1902077	FILT0075
6.	E214L	LX345	C24508	243 x 132 x 376	EuroCargo, SuperCargo	1907553	FILT0300
7.	E270L	LX626	C331600/1	327 x 216 x 515	EuroTrakker, EuroStar, Stralis	1907695	FILT0297
8.	E119L74		C33921	327 x 216 x 618	EuroTrakker Cursor 8,13	2291793	FILT0057
9.	E602L			78 x 63 x 60,1 x M16 1,5	EuroTrakker, EuroStar Cursor R, EuroTech Cursor, Eurorider, Stralis	500339085	FILT0312
10.	E75KD42	KX23	P917X	88 x 77 x 84 x 71,5	Zeta, TurboZeta,	1901929	FILT0212
11.	H70WK	KC68	WK842	82 x 61,5 x M16 x 1,5 x 154	Zeta 109-14, 8060.05.289	1909142	FILT0378
12.	H60WK01	KC68	WK731	76 x 62 x M16 x 1,5 x 119	TurboStar, EuroCargo, EuroTech,	1902134	FILT0054



IVECO							
Poz.	Hengst broj	Knecht/ Mahle broj	Mann broj	Dimenzije (mm)	Tip vozila	OE broj	RAPIDEX broj
13.	E10KPD10	KX36	P811X	83 x 13,8 x 13,8 x 145	8220.02.701	1900820	FILT0245
14.	H70WK09	KC186	WK950/6	96 x 62 x M14 x 1,5 x 191	EuroTrakker, EuroCargo, EuroRider, EuroStar, EuroTech, Stralis	1931061	FILT0307
15.	E595L		C25860/3	248 x 150 x 415	Eurocargo 120-320E tector	42471166	FILT0360
16.	E713L		C24745/3	228 x 150 x 415	Eurocargo 120-320E tector	2992388	FILT0112
17.	E633L	LX1072	C25660/1	244 x 150 x 335	Eurocargo 65, 75, 80, 90, 100, 120, 130, 140, 150, 180	42471161	FILT0101
18.	E681L			313,5 x 216,5 x 461	Stralis AD, AT, AS.Trakker	41272124	FILT0209
19.	H215WK			96 x 62 x M16 x 1,5 x 196	Stralis, EuroCargo II, Trakker	87435525	FILT0251
20.	E1908LI	LA170	CU4594	450 x 200 x 25	Stralis AD, AT, AS.Trakker	2995964	FILT0049
21.	E10H02		H601/4	58 x 18,5 x 18,5 x 100	Zeta, TurboZeta, TurboTech, Stralis TurboStar, TurboCity, Irisbus...	1902137	FILT0214
22.	H17W04	OC26	W940/5	93 x 62 x 1-12UNF x 154	8220.12.709, 8220.32.723...	1902135	FILT0380
23.	H230W	OC474	W1170/7	108 x 93 x M30 x 2 x 228,5	Cursor E0681A/B/C/D/E/F...	1931099	FILT0250
24.	H200W01	OC486	W11102/4	108 x 93 x 1 1/8-16UN x 260	EuroClas 389.10.31, 389.12.31	42537127	FILT0252

MAN							
Poz.	Hengst broj	Knecht/ Mahle broj	Mann broj	Dimenzije (mm)	Tip vozila	OE broj	RAPIDEX broj
1.	E115L	LX265	C20235/3	198 x 103 x 376	G/M90, L/M2000	81.08304.0056	FILT0075
2.	E116L	LX227	C23440/1	228 x 116 x 381	8 - 32t, NM, SD, SL, M01, M03, M05, ...	81.08304.0064	FILT0224
3.	E118L	LX273	C301537	302 x 191 x 473	F/G/M90, M2000, ...	81.08304.0044	FILT0323
4.	E214L	LX345	C24508	243 x 132 x 376	L/M2000, NG, NL, NM, SM, ...	81.08304.0074	FILT0300
5.	E218L	LX531	C30703	302 x 191 x 381	NL, NG, SG, Lions	81.08304.0086	FILT0058
6.	E237L	LX612	C301353	303 x 167 x 477,50	F90, F2000, F2000 Evolution	81.08304.0097	FILT0275
7.	E307L	LX560/1	C25730/1	248,5 x 119 x 382	L/M2000, L/M2000 Evolution	81.08304.0087	FILT0295
8.	E428L01		C271250/1	265 x 170 x 511	TGA	81.08405.0021	FILT0277
9.	E661L	LX1768	C23513/1	227 x 130 x 305	TGL, TGM	81.08405.0023	FILT0278
10.	E811L	LX7210/7		250 x 125 x 460	TGL, TGM	81.08405.0018	FILT0117
11.	E428LS	LXS277	CF1640	155,5 x 137 x 456,5	TGA, TGS, TGX	81.08405.0017	FILT0381
12.	E422KPD98		P1059x	95 x 46 x 172,5	TGA 310-430, D2066LF01-04/11, ...	51.12503.0063	FILT0284
13.	E1030K			89 x 89 x 55	A51-A85, F2000, TGA	81.12503.0086	FILT0334
14.	E10KPD10	KX36	P811X	83 x 13,8 x 145	F90, M90, D0826LUH	81.12503.0063	FILT0245
15.	E6KS			45 x 7,8 x 84	Bus Lions	81.11101.6151	FILT0216
16.	E11S03D132		PU50X	50 x 23 x 40 x 41	TGA, Lions Bus	51.12503.0043	FILT0217
17.	H7090WK30			108 x 80 x 1-14UNS x 157	MAN	51.12503.0066	FILT0210
18.	E906LI	LA67	CU40110	401,8 x 187 x 31	F2000, LE-Serie, M2000	81.61910.0011	FILT0199
19.	E954LC		CUK4795	470 x 184 x 70	TGA	81.61910.0019	FILT0276
20.	E954LI		CU4795	472 x 189 x 70	TGA	81.61910.0018	FILT0236
21.	E10H02		H601/4	58 x 18,5 x 100	F/G/M90, F/L/M2000, TGA	81.47301.6005	FILT0214
22.	E13HD47	OX146D	HU1381X	121 x 56 x 56 x 148	F2000, TGA	51.05504.0098	FILT0322
23.	E56KPD72	KX73/1D	PU855X	76 x 27,5 x 12 x 229	TGA.D0836 LUH, LOH.LF	51.12503.0048	FILT0314
24.	H210W01	OC206	W1160	109 x 92 x M30 x 2 x 180,5	G/M90, F/L/M2000	51.05501.7180	FILT0225
25.	E172HD35	OX123/1D	HU951X	83 x 37 x 37 x 174	TGA, D0836 LF, LUH	51.05500.6073	FILT0320
26.	E161HD28	OX155D	HU947/2X	83 x 37 x 28 x 212,5	F90, F2000, TGA	51.05504.0096	FILT0003
27.	E197HD31	OX137D2	HU947/1n	83 x 21 x 21 x 193	F90, F2000, TGA	51.05504.0094	FILT0246
28.	E422HD86		HU13125x	121 x 57 x 15 x 203,5	TGA	51.05504.0108	FILT0325

1

MERCEDES							
Poz.	Hengst broj	Knecht/ Mahle broj	Mann broj	Dimenzije (mm)	Tip vozila	OE broj	RAPIDEX broj
1.	E115L	LX265	C20235/3	198 x 103 x 376	SK (358, 625, 645-648, 655-) Unimog	001 094 42 04	FILT0075
2.	E116L	LX227	C23440/1	228 x 116 x 381	LK, MK, 8-24t, O303, Unimog	001 094 47 04	FILT0224
3.	E118L	LX273	C301537	302 x 191 x 473	O350 Turismo	003 094 50 04	FILT0323
4.	E133L	LX92	C20356	302 x 191 x 460	LK 809-1114 (673, 674, 675)	002 094 73 04	FILT0102
5.	E209L	LX335	C60345	597,5 x 170,5 x 81	T2508D-914D, LK710-914, Vario	004 094 41 04	FILT0301
6.	E214L	LX345	C24508	243 x 132 x 376	O350, O404	003 094 60 04	FILT0300
7.	E240L	LX511/1	C32338	314,5 x 276,5 x 70,5	Sprinter (901, 902, 903, 904)	003 094 82 04	FILT0068
8.	E272L	LX674	C331840	327 x 191 x 479	18 - 35t SK (625-659)	003 094 70 04	FILT0352
9.	E273L	LX441	C331015	327 x 261 x 256	MK (650-654), SK (655-659)	003 094 49 04	FILT0242
10.	E275L	LX263	C28715	338 x 133 x 254	LK(675-679), MK(650-653), K624	001 094 93 04	FILT0074
11.	E284L	LX80	C331305	387 x 167 x 356	617-648, LK, MK, SK (625-659)	002 094 24 04	FILT0240
12.	E295L	LX388	C15200	152 x 73 x 333	207-210, 307-309, 408-410, O100	003 094 51 04	FILT0087
13.	E297L	LX507	C421404	420 x 254 x 262,5	Actros, Atego, Axor	004 094 33 04	FILT0296
14.	E312L	LX506	C421729	420 x 280 x 305	Actros, Atego, Axor, Econic	003 094 91 04	FILT0294
15.	E314L	LX739	C291219/1	281,5 x 127 x 414,5	Actros	004 094 02 04	FILT0293
16.	E315L	LX747	C641500	633 x 570,5 x 765	Actros	004 094 11 04	FILT0292
17.	E361L	LX776	C291032/1	276 x 125 x 345,5	Atego, Econic	003 094 96 04	FILT0289
18.	E497L	LX814/1	C411776	520,5 x 221,8 x 332,3	Actros II 04.2003 -, Blue Tec, Axor	004 094 25 04	FILT0318
19.	E603L	LX1734		265 x 170 x 530	Actros II	004 094 35 04	FILT0234
20.	E1600L			125,5 x 74 x 320	Sprinter I, Vito I CDI	004 094 05 04	FILT0361
21.	E10KPD10	KX36	P811X	83 x 13,8 x 145	OM346.910-952, 352.916, 360, 403	945 508 02 00	FILT0245
22.	H35WK02D87	KC63/1D	WK817/3x	89 x 72 x M12 x 1,5 x 97	Unimog, OM601, 602	002 092 30 01	FILT0309
23.	H103WK	KL330F	WK31/5	36 x 102	Unimog OM616	001 477 79 01	FILT0095
24.	E5KFR2D12	KX68D	BF700X	70 x 11 x 115	LK/LP/MK/NG OM352, 357, 401, 422	000 092 54 05	FILT0382
25.	E10KFR4D10	KX65D	BF900X	83 x 13,8 x 145	SK/MK/NG, OM401, 421, 422, 441	000 090 14 51	FILT0243
26.	H278WK		WK842/23X	92 x 120	Sprinter CDI	646 092 07 01	FILT0110
27.	H167WK		WK842/18	91 x 120	Sprinter CDI, Vito	665 092 00 01	FILT0077
28.	H70WK11	KL100/1	WK842/13	91 x 128	Sprinter CDI, Vito	611 092 06 01	FILT0070



1

MERCEDES							
Poz.	Hengst broj	Knecht/ Mahle broj	Mann broj	Dimenzije (mm)	Tip vozila	OE broj	RAPIDEX broj
29.	H701WK			107,4 x 104 x 219	OM457, 541, 542	000 477 13 02	FILT0218
30.	H7090WK30			108 x 91 x 167	375.101-122, 628.040-050	375 477 00 02	FILT0210
31.	E982LI	LA43	CU3855	391 x 143,5 x 39	Actros I, 942.899, 943.899	000 830 12 18	FILT0001
32.	E931LI	LA42	CU3869	389 x 134 x 33	Actros I, 942.899, 943.899	000 830 11 18	FILT0230
33.	E1904LI			336 x 98 x 5	Atego, Actros 942.899	001 835 07 47	FILT0302
34.	E933LI	LA85	CU5877	579 x 163 x 38	Atego, Econic	973 835 01 77	FILT0268
35.	E980LI			454 x 190 x 56	Axor	940 835 00 47	FILT0263
36.	E2916LI		CU3569	354 x 235 x 34	New Sprinter	906 830 02 18	FILT0118
37.	E912LC		CUK3858	376 x 168 x 28	Sprinter 901, 902, 903, 904	901 830 04 18	FILT0135
38.	E10H02		H601/4	58 x 18,5 x 100	LK/MK/SK/NG, Vario, Atego, Actros, Axor	000 184 22 25	FILT0214
39.	E500KP02D36	KX80D	PU999/1X	106 x 46 x 222,5	Actros, Axor, Conecto, Citaro, Travego, Integro	541 092 09 05	FILT0228
40.	EAS500MD38	SOX1	C7161	64,6 x 31 x 120,3	Actros, Travego	541 010 00 80	FILT0226

1

MERCEDES							
Poz.	Hengst broj	Knecht/ Mahle broj	Mann broj	Dimenzije (mm)	Tip vozila	OE broj	RAPIDEX broj
41.	E502H02D121		SP2041-2X	120,5 x 50 x 271,5	Actros II	541 180 01 09	FILT0317
42.	E161H01D28	OX174D		83 x 37 x 211,5	Atego, Axor, Conecto, Econic, Citaro	000 180 17 09	FILT0244
43.	E52KPD36	KX67/2D	PU1046X	91,8 x 44,9 x 102,7	LK, Atego, Econic, Cito, Tourino	000 090 12 51	FILT0316
44.	E160H01D28	OX161D	HU931/5X	83 x 37 x 149,5	LK, Atego, Vario	000 180 16 09	FILT0321
45.	E134HD06	OX150D	HU932/4X	83 x 21 x 137	LK/LN, LP, MK, NG OM314	000 180 09 09	FILT0229
46.	E197HD23	OX137D1	HU947/1Z-2	83 x 21 x 199	MK, SK, OM401, 422, 423, 442, 443	401 180 01 09	FILT0198
47.	E251HD11	OX69D	H12110/2X	120 x 13,4 x 270	MK, NG, Conecto, OM421-423, 442	002 184 77 25	FILT0227
48.	E11HD57	OX153D3	HU718/4X	65 x 32,3 x 116	Sprinter, Vito, Viano,	001 184 94 25	FILT0069
49.	E172HD35	OX123/1D	HU951X	83 x 37 x 174	Vario 512-812D, OM601-602	602 180 00 09	FILT0320
50.	E500HD129	OX168D	HU12140X	121 x 44,5 x 311,5	Actros, MP2, Travego	541 180 02 09	FILT0237

RENAULT							
Poz.	Hengst broj	Knecht/ Mahle broj	Mann broj	Dimenzije (mm)	Tip vozila	OE broj	RAPIDEX broj
1.	E115L	LX265	C20235/3	198 x 103 x 376	RVI D100, DG100, GC, GLR, PR	5000241796	FILT0075
2.	E116L	LX227	C23440/1	228 x 116 x 381	RVI CLR230, Midliner, Midlum	5010317163	FILT0224
3.	E117L	LX273	C301537	302 x 191 x 473	RVI PR180	5000242504	FILT0324
4.	E279L	LX229	C23690	420 x 254 x 262,5	RVI G ... (Manager/Maxter)	4033128140	FILT0384
5.	E297L	LX507	C421404	420 x 254 x 262,5	RVI CBH340, CLM340	5000241284	FILT0296
6.	E10KFR4D10	KX65D	BF900X	83 x 13,8 x 145	RVI	5000031068	FILT0243
7.	H18WDK02		WK940/20	93 x 71 x 144	RVI Magnum, Midlum, Premium	5010505337	FILT0200
8.	E75KD42	KX23	P917X	88 x 77 x 71,5	RVI Messenger, Manager, Premium	7701010100	FILT0212
9.	Z13D94	OZ3	ZR904X	97,8 x 12,50 x 119	AE Magnum, Iliade, Kerax, Premium	4125030024	FILT0202
10.	E10H02		H601/4	58 x 18,5 x 100	Magnum, Premium, Midlum	5000820895	FILT0214
11.	H200W01	OC121	W11102/4	110 x 11/816UN x 260	Magnum, Premium, Midlum	5010550600	FILT0252
12.	E452L	LX713	C321447	312 x 186 x 465,5	Premium, Magnum, Midlum	5010230841	FILT0201
13.	E452LS	LXS224		180 x 145,4 x 444,5	Magnum, Premium, Midlum	5010317187	FILT0127
14.	E2927LI			227 x 107 x 20	Midlum, Premium	5001010063	FILT0197
15.	H10W02	OC83	W920/7	93 x 72 x 109	Midlum, Premium	5001846635	FILT0064
16.	H200W04	OC370		108 x 101 x 259,5	Premium II, Magnum	5001846642	FILT0255

1

SCANIA							
Poz.	Hengst broj	Knecht/ Mahle broj	Mann broj	Dimenzije (mm)	Tip vozila	OE broj	RAPIDEX broj
1.	E116L	LX227	C23440/1	228 x 116 x 381	B86, BR86S	235586	FILT0224
2.	E127L	LX84	C271390	271 x 159,5 x 570	→144, P/T420, P/R/T470	1 801 772	FILT0055
3.	E218L	LX531	C30703	302 x 191 x 381	BN/CN/CR/F113, K/P/R/S113, R143	371307	FILT0058
4.	E290L	LX712	C301500	303 x 167 x 526	144, 164, R/T 500V8, R/T 580V8	1 377 099	FILT0232
5.	E424L	LX604/1	C311254	309 x 177 x 464	P/R/T 124, P230-470, R230-470	1 801 775	FILT0283
6.	E451L	LX714	C301240	303 x 167 x 446	P/R/T 124, 164V8, 114	1 421 022	FILT0231
7.	E540L	LX227	C311495	304 x 178 x 543	→144, P/T420, P/R/T470	1 801 774	FILT0315
8.	H17WK04	KC94	WK940/12	93 x 62 x M24 x 1,5 x 141	94, 124, 144, DC12, DSC12, DT	1 372 444	FILT0261
9.	H17WK05	KC184	WK940/2	93 x 62 x M24 x 1,5 x 144	94, 124, 144, DC12, DSC12, DSC9, DC11	1 763 776	FILT0260
10.	T350W			148 x 12 x 168	P/R94, P/R114, P/R124, 144, 164V8	1 393 551	FILT0304
11.	H7090WK30			108 x 80 x 1-14UNS x 157	Serija 4	1 393 640	FILT0210
12.	H34WF		WA923/2	94 x 62 x 105,5	Serija 3, 4	378396	FILT0310
13.	H60WK08		WK723/1	70 x 62 x 126,5	Serija 2, 3, Bus K113	1 401 462	FILT0006
14.	E10H02		H601/4	58 x 18,5 x 100	P/R94, P/R114, P/R124, 144, 164V8	1 953 094	FILT0214
15.	H17W04	OC26	W940/5	93 x 62 x 154	K114, DSC11	1 347 591	FILT0380
16.	H10W02	OC83	W920/7	93 x 62 x 109	113, 142, 143,	173171	FILT0064
17.	H200W02	OC246	W11102/20	110 x 93 x 260	94, 114, 124, 144	1 347 726	FILT0256
18.	H24W05		W930/14	94 x 62 x 113,5	93, 94, 114, 124, 144,	1 301 696	FILT0249
19.	E41H		H929/3	84 x 19,5 x 107	Serija 3, 4, P, R, T	1 381 235	FILT0287

VOLVO							
Poz.	Hengst broj	Knecht/ Mahle broj	Mann broj	Dimenzije (mm)	Tip vozila	OE broj	RAPIDEX broj
1.	E115L	LX265	C20325/3	198 x 103 x 376	FLC 140	7362224	FILT0075
2.	E316L	LX832	AF25238	332 x 200 x 414	FH12	1665898	FILT0291
3.	E317L	LX1280		353 x 202 x 412	FH16	1665908	FILT0290
4.	E420L	LX1281		356 x 200 x 414	FH12	8149961	FILT0286
5.	E566L		C913/1	88 x 26 x 92	FL608-619, F12, F16	6888780	FILT0235
6.	E699L		C19620	207 x 135 x 580	FL6	6776715	FILT0215



VOLVO							
Poz.	Hengst broj	Knecht/ Mahle broj	Mann broj	Dimenzije (mm)	Tip vozila	OE broj	RAPIDEX broj
7.	E420LS			202,5 x 170 x 448	FH12, FH16	3162323	FILT0285
8.	E496LS	LX1587		168 x 134 x 441	FM7, FM9, FM12	3979928	FILT0004
9.	E75KD42	KX23	P917X	88 x 77 x 71,5	F406, F407	7236628	FILT0212
10.	H70WK	KC68	WK842	82 x 61,5 x 154	F406-409, FL408, FLC140	3976655	FILT0378
11.	H700WK			93 x 96 x 141	FH12, FH16	20998346	FILT0219
12.	H60WK07	KC24	WK723	76 x M16 x 1,5 x 124	B12, F10, F12, F16, FH16, FL	72430049	FILT0005
13.	H200WDK		WDK11102/1	108 x 93 x 262,50	FH12, FH16, FM9	20405160	FILT0254
14.	H18WK03	KC75	WK962/7	95 x 62 x 213	FH, FM	8193841	FILT0259
15.	E28H		HU721	65 x 32,3 x 151	FH12, FH16, FM7, FM9, FM12	20776259	FILT0076
16.	H28WF			96,5 x 63 x 147	FH12, FH16, FH, FL, FM, B12	20532237	FILT0248
17.	H7090WK30			108 x 80 x 157	FH12, FH16, FL, FM7, 9, 10, 12	81599755	FILT0210
18.	E1905LI		CU2785	270 x 188 x 45	F7, F10, F12, F16, FL7, 10, 12	47714779	FILT0383
19.	E947LI	LA148	CU2184	211 x 209 x 52,5	F12, F16, FH12, FH16	8143691	FILT0267
20.	H28WF			96,5 x 63 x 147	FH12, FH16, F16, FL12, FM7, 9, 12	20532237	FILT0248
21.	E10H02		H601/4	58 x 18,5 x 100	FL12, FH12, FM	3496197	FILT0214
22.	E28H		HU721	65 x 32,3 x 151	FH12-16, FM7-12, D12C/D	20776259	FILT0076
23.	H200WN	OC282	WP11102	110 x 93 x 260	F12-16, FH12-16, FL6-12, FM7-12	8121109	FILT0253
24.	H200W04	OC370		108 x 92 x 259,50	FH12, FH16, B12, F12, FM7-12	4787362	FILT0255

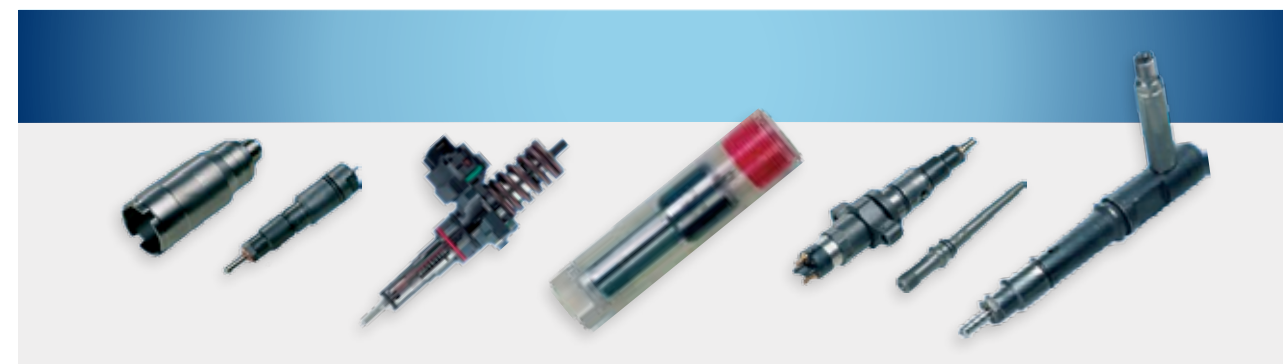

BRIZGALJKE I ULOŠCI BRIZGALJKI					
Poz.	Tip vozila	Tip motora	KBP	OE broj	RAPIDEX broj
1.	DAF F95	WS222-315G	DLLA145S1160	1207731	NAP0089
2.	DAF F85, F95	WS222-315G	DLLA152S1277	1284294	NAP0090
3.	DAF 85CF, 95XF	XF250/XE250C-XF355MC	DLLA155P657	1315101	NAP0091
4.	DAF 95.310 ATI	WS225	DLLA140S1117	066130	NAP0092
5.	DAF 95.300, 330, 360	WS222G, WS242, WS268G	DLLA145S1161	1207730	NAP0093
6.	DAF 95.350, 380	WS259, WS282	DLLA140S1116	066131	NAP0094
7.	DAF 95.430	WS315M	DLLA152S1280	1285073	NAP0095
8.	DAF 95XF		DLLA153P810	1350083	NAP0016
9.	IVECO	8060.25	DLLA136S1000	4800030	NAP0096
10.	IVECO Euro Trakker, Euro Star, Euro Tech	8210.42	DLLA143S1302	99434328	NAP0097
11.	IVECO TurboTech, TurboStar, EuroTrakker, EuroStar, EuroTech	8210.42	DLLA145S1169	98413209	NAP0098
12.	IVECO, KHD (Deutz)	F6L, 8L, 10L, 12L413	DLLA28S656	2145081	NAP0099
13.	IVECO EuroTrakker, EuroStar, EuroTech	9460.41CE2, 8460.41L	DSLA134P816	500338048	NAP0100
14.	MAN	D0826, D0824	DLLA134P180	51.10102.0202	NAP0101
15.	MAN	D0826, D0824	DSLA154P492/	51.10102.0234	NAP0102
16.	MAN	D0826	DSLA78P322	51.10102.0216	NAP0103
17.	MAN	D0826	DLLA140P175	51.10102.0199	NAP0104
18.	MAN	D2566	DSLA154P625	51.10102.0237	NAP0105
19.	MAN, Setra	D2566	DLLA30S678	51.10102.0146	NAP0106

BRIZGALJKE I ULOŠCI BRIZGALJKI					
Poz.	Tip vozila	Tip motora	KBP	OE broj	RAPIDEX broj
20.	MAN, Setra	D2566	DLLA25S722	51.10102.0150	NAP0107
21.	MAN	D2566	DLLA30S931	51.10102.0188	NAP0108
22.	MAN	D2866, D2840	DLLA136S943	51.10102.0189	NAP0109
23.	MAN	D2866, D2865	DLLA144P184	51.10102.0205	NAP0110
24.	MAN	D2865	DLLA146P166	51.10102.0206	NAP0111
25.	MAN	D2865 LUH	DLLA152P531	51.10102.0231	NAP0112
26.	MAN	D2866, D2876	DLLA152P452	51.10102.0221	NAP0064
27.	MAN	D2876, TGA	DLLA154P866	51.10102.0252	NAP0063
28.	MAN	TGA COMMON RAIL	DLLA144P1417	51.10102.0304	NAP0113
29.	MERCEDES	OM352, OM314	DLLA150S187	000 017 39 12	NAP0081
30.	MERCEDES	OM366, OM364	DLLA134P430	002 017 55 12	NAP0012
31.	MERCEDES	OM366, OM364	DLLA142S791	001 017 14 12	NAP0114
32.	MERCEDES	OM366, OM364, OM352	DLLA142S792	001 017 15 12	NAP0115
33.	MERCEDES	OM366, OM364	DLLA142S926	001 017 45 12	NAP0116
34.	MERCEDES	OM366, OM364	DLLA142S1096	001 017 75 12	NAP0117
35.	MERCEDES	OM366, OM364	DLLA142S1173	001 017 93 12	NAP0118
36.	MERCEDES	OM366	DLLA134S1201	002 017 10 12	NAP0119
37.	MERCEDES	OM442, 441	DLLA142P418	002 017 48 12	NAP0120
38.	MERCEDES	OM441	DLLA142P419	002 017 49 12	NAP0121
39.	MERCEDES	OM401, 402, 407, 404	DLLA144S485	000 017 60 12	NAP0122
40.	MERCEDES	OM442, 443, 441	DLLA134S999	001 017 82 12	NAP0123
41.	MERCEDES	OM421, 422, 423	DLLA144S829	001 017 16 12	NAP0124
42.	MERCEDES	OM421, 423	DLLA140S1003	001 017 30 12	NAP0125
43.	MERCEDES	OM441, 402, 442, 447	DLLA138S1191	001 017 97 12	NAP0068
44.	MERCEDES	OM441, 442	DLLA134S1199	002 017 09 12	NAP0126
45.	MERCEDES	Atego	DLLA156P1059		NAP0127
46.	MERCEDES	Atego	DSLA156P1411		NAP0128
47.	MERCEDES	Actros OM541,542	DLLA154P596		NAP0062
48.	MERCEDES	OM541, 542, 457	DLLA150P943		NAP0129

BRIZGALJKE I ULOŠCI BRIZGALJKI					
Poz.	Tip vozila	Tip motora	KBP	OE broj	RAPIDEX broj
49.	MERCEDES	Actros OM541, 542	DLLA150P1120		NAP0130
50.	SCANIA	Seriya 4 Truck, Bus	DLLA150P847	1 409 192	NAP0131
51.	SCANIA	Seriya 4 Truck, Bus	DLLA150P848	1 412 401	NAP0132
52.	SCANIA	Seriya 4, DC11, 12, 16	DLLA150P898	1 438 333	NAP0133
53.	SCANIA	Seriya 4, DC11, 12, 16	DLLA150P635	1 380 777	NAP0134
54.	SCANIA	Seriya 3, 4 Truck, Bus	DLLA155P306	1 327 377	NAP0135
55.	SCANIA	Seriya 4 Truck, Bus	DLLA150P573	1 375 440	NAP0136
56.	SCANIA	Seriya 4 Truck, Bus	DLLA147P538	1 364 500	NAP0137
57.	VOLVO	B10, C10M, F10, FL10	DLLA150P52	1 545153	NAP0138
58.	VOLVO	B58, F10	DLLA150S178	238896	NAP0139
59.	VOLVO	F12, B12, NL12	DLLA148P149	470934	NAP0140
60.	VOLVO	B10L, B10M	DLLA150P555	425694	NAP0141
61.	VOLVO	B10M, FL10, FM10	DLLA152P571	8194095	NAP0142
62.	VOLVO	FH12	DLLA155P572		NAP0143
63.	VOLVO	FH12	DLLA155P872		NAP0144
64.	VOLVO	FH12	DLLA152P903		NAP0145
65.	VOLVO	FH12	DLLA152P932		NAP0146
66.	VOLVO	FH16	DLLA148S1272		NAP0147



INJEKTORI I PUMPE VISOKOG PRITISKA

Poz.	Tip vozila	Tip motora	KBP	OE broj	RAPIDEX broj
1.	MAN	D2866EU3, LF, LUH, LOH	DLLA152P967	51.10102.0259	NAP0148
2.	MAN	D2866, 2876	DLLA154P866	51.10102.0252	NAP0063
3.	MAN	D0834, 0836	DSLA157P955	51.10102.0260	NAP0149
4.	MAN	D0836	DSLA154P960	51.10102.0258	NAP0007
5.	MAN	D2866 LF, LUH, LOH	DLLA152P1231	51.10102.0277	NAP0150
6.	MAN	D2866 LUH	DLLA152P1466	51.10102.0305	NAP0151
7.	MAN	D2866, 2876	DLLA152P452	51.10102.0221	NAP0064
8.	MAN	TGL, TGM, D0834, D0836	0 445 120 045	51.10100.6050	NAP0152
9.	MAN	TGL, TGM, D0834, D0836	0 445 120 098	51.10100.6065	NAP0153
10.	MAN	TGA D2066, D2876	0 445 120 030	51.10100.6032	NAP0154
11.	MAN	TGA D2066	0 445 120 061	51.10100.6064	NAP0155
12.	MAN	TGA 26.280, 330	0 445 020 014	51.11103.7655	NAP0156
13.	MAN	TGA 18, 24, 26, 28, 32, 33, 35, 41	0 445 020 018	51.11103.7740	NAP0157
14.	MAN	TGA 8, 24, 26, 28, 32, 33, 35, 41	0 445 020 023	51.11103.7738	NAP0158
15.	MERCEDES	OM457	0 432 191 384	005 017 53 21	NAP0159
16.	MERCEDES	Actros MP2	0 432 191 446	005 017 13 21	NAP0160
17.	MERCEDES	Actros MP2	0 432 191 348	005 017 45 21	NAP0161
18.	MERCEDES	Actros MP2, Axor, Citaro, Conecto	0 432 191 347	005 017 46 21	NAP0162
19.	MERCEDES	Actros MP2	0 432 191 363	005 017 39 21	NAP0163
20.	MERCEDES	Actros MP2	0 433 171 628		NAP0129
21.	MERCEDES	Actros MP2	0 433 171 740		NAP0164
22.	MERCEDES	Actros MP2	0 433 171 741		NAP0165
23.	MERCEDES	Actros MP2	0 433 171 724		NAP0166

AC PUMPE

Poz.	Tip vozila	OE broj	RAPIDEX broj
1.	DAF F85, 95, 85CF, 95XF	1339048	NAP0169
2.	DAF 75, 85CF, 95XF, XF95	1332609	NAP0170
3.	MAN D0824, D0826	51.12101.7136	NAP0171
4.	MAN D0826, 0836, 2866, 2876	51.12150.7022	NAP0172
5.	MAN D0826, 0836, 2866, 2876	51.12101.7101	NAP0173
6.	MAN D2566, D2866	51.12101.7038	NAP0174
7.	MAN D0826, 0836, 2866, 2876	51.12501.7228	NAP0175
8.	MERCEDES OM400, OM420, OM440	000 090 21 50	NAP0176
9.	MERCEDES OM400, OM420, OM440	000 090 30 50	NAP0177
10.	MERCEDES OM400, OM420, OM440	000 091 21 90	NAP0072
11.	MERCEDES OM400, OM420, OM440 ACTROS	000 090 60 50	NAP0021
12.	SCANIA DSC9, DC9	1 375 493	NAP0178
13.	SCANIA DC11, DSC11, DSC12	1 307 770	NAP0179
14.	SCANIA DC9, DC11, D12	1 539 298	NAP0180
15.	SCANIA DC16	1 536 255	NAP0181
16.	VOLVO D10B, D16A, D16B	863474	NAP0182
17.	VOLVO D12A	8148997	NAP0183

REZERVOARI GORIVA

Poz.	Tip vozila	Dimenzija (mm)	Zapremina (l)	RAPIDEX broj
1.	DAF	2300 x 670 x 620	870	NAP0184
2.	DAF F85, F85C, F95, F95XF	1460 x 720 x 720	700	NAP0185
3.	IVECO	2050 x 680 x 625	800	NAP0186
4.	IVECO EuroStar, EuroTech	1460 x 720 x 720	700	NAP0034
5.	IVECO EuroStar, EuroTech	1960 x 720 x 720	930	NAP0187
6.	MAN	1050 x 675 x 620	400	NAP0188
7.	MAN	1600 x 675 x 620	600	NAP0189
8.	MAN F2000	1460 x 720 x 720	700	NAP0190
9.	MAN TGA	1960 x 720 x 720	930	NAP0191
10.	MERCEDES	1560 x 685 x 625	600	NAP0192
11.	MERCEDES Sprinter	1506 x 530 x 210	145	NAP0193
12.	MERCEDES Atego, Actros	1960 x 720 x 720	930	NAP0194
13.	RENAULT Magnum	1960 x 720 x 720	930	NAP0195
14.	SCANIA 4	1460 x 720 x 720	700	NAP0196
15.	SCANIA 4	1960 x 720 x 720	930	NAP0197
16.	VOLVO	1200 x Ø710	450	NAP0198
17.	VOLVO FH12, FH16	850 x 720 x 720	400	NAP0199
18.	VOLVO FM7, FM10, FH12, FH16	1460 x 720 x 720	700	NAP0200
19.	VOLVO FM7, FM10, FH12, FH16	1960 x 720 x 720	930	NAP0201

PLOVCI

Poz.	Tip vozila	OE broj	RAPIDEX broj
1.	DAF F95	104950	NAP0202
2.	IVECO EUROSTAR, CURSOR, STRALIS	41042769	NAP0203
3.	IVECO EUROTRAKKER, EUROTRAK CURSOR	41042771	NAP0204
4.	MAN M/F90, M2000, F2000, TGA	81.27201.6094	NAP0020
5.	MAN M/F90, M2000, F2000, TGA	81.27203.6033	NAP0205
6.	MERCEDES ACTROS	011 542 71 17	NAP0038
7.	MERCEDES ACTROS	013 542 78 17	NAP0040
8.	MERCEDES AXOR	013 542 73 17	NAP0043
9.	MERCEDES LK, MK, NG	008 542 80 17	NAP0206
10.	MERCEDES SK	011 542 68 17	NAP0207
11.	RENAULT MAGNUM, MIDLUM, PREMIUM	5010505318	NAP0208
12.	SCANIA 94, 114, 124, 144, 164	1 423 990	NAP0209
13.	SCANIA 94, 114, 124, 144, 164	1 424 074	NAP0210
14.	VOLVO FH12, FM	20732304	NAP0211
15.	VOLVO FL6, FH12, FH16	20732301	NAP0212

POKLOPCI

Poz.	Naziv	Tip vozila	OE broj	RAPIDEX broj
1.	POKLOPAC REZERVOARA Ø60 mm	DAF F75, F85, F95	109996	OPRE0455
2.	POKLOPAC REZERVOARA Ø80 mm	DAF 85CF, 95XF, CF85, XF95	1697734	OPRE0456
3.	POKLOPAC ULJA	DAF F75, F85, F95	1277092	OPRE0457
4.	POKLOPAC EKSPANZIONE POSUDE	DAF XF95, XF105	1685352	OPRE0458
5.	POKLOPAC REZERVOARA Ø80 mm	MAN M/F90, M/L2000, TGL, TGM, TGA	81.12210.6027	OPRE0074
6.	POKLOPAC ULJA	MAN D0826, 0836, 2066, 2866, 2876	81.12210.0007	OPRE0459
7.	POKLOPAC EKSPANZIONE POSUDE	MAN M/F90, M/L2000, TGL, TGM, TGA	81.06111.0018	OPRE0460
8.	POKLOPAC EKSPANZIONE POSUDE	MAN M/F90, M/L2000, TGL, TGM, TGA	81.06111.0020	OPRE0461
9.	POKLOPAC EKSPANZIONE POSUDE	MAN TGA, TGX	81.06110.0007	OPRE0462
10.	POKLOPAC REZERVOARA Ø80 mm	MERCEDES SK, MK, NG, ACTROS, AXOR	000 471 67 30	OPRE0463
11.	POKLOPAC REZERVOARA Ø80 mm	MERCEDES ATEGO, ACTROS, AXOR, UNIMOG	000 470 04 05	OPRE0464
12.	POKLOPAC ULJA	MERCEDES SK, MK, NG, ACTROS, AXOR	111 018 03 02	OPRE0465
13.	POKLOPAC HLADNJAKA	MERCEDES SK, MK, NG, ACTROS, AXOR	000 501 64 15	OPRE0466
14.	POKLOPAC REZERVOARA	RENAULT MAGNU, PREMIUM, MIDLUM	5001864551	OPRE0467
15.	POKLOPAC ULJA	RENAULT MAGNU, PREMIUM, MIDLUM	0000149310	OPRE0468









POKLOPCI

Poz.	Naziv	Tip vozila	OE broj	RAPIDEX broj
16.	POKLOPAC REZERVOARA Ø60 mm	SCANIA SERIJA 4, 94, 114, 124, 144, 164	1 481 301	OPRE0469
17.	POKLOPAC ULJA	SCANIA DSC, DC9, 11, DSC14	1 385 367	OPRE0470
18.	POKLOPAC EKSPANZIONE POSUDE	SCANIA SERIJA 4, 94, 114, 124, 144, 164	1 374 050	OPRE0471
19.	POKLOPAC REZERVOARA Ø60 mm	VOLVO FH12, FH16, FM9, FM12	1079940	OPRE0472
20.	POKLOPAC REZERVOARA Ø80 mm	VOLVO FH12, FH16, FM9, FM12	20392751	OPRE0473
21.	POKLOPAC ULJA	VOLVO FH12, FH16, FM9, FM12	1675839	OPRE0474
22.	POKLOPAC HLADNJAKA	VOLVO FH12, FH16, FM9, FM12	1674083	OPRE0475



DAVAČI I SENZORI						
Slika	Poz.	Tip vozila	Tip motora	Dimenzije (mm)	OE broj	RAPIDEX broj
	1.	DAF	F3300/3600, 2800, Bus	0-10 bar, M14 x 1,5	287909	ELEK0735
	2.	DAF	F3300/3600, 2800, Bus	M14 x 1,5 120°C	248179	ELEK0736
	3.	DAF	F3300/3600, 2800, Bus		248180	ELEK0737
	4.	DAF	F3300/3600, 2800, Bus		672060	ELEK0738
	5.	DAF	Daf AVM		248178	ELEK0739
	6.	DAF	F85, F95, 75CF, 85CF, 95XF, XF95		1252439	ELEK0740
	7.	DAF	F85, 95, CF, 95XF, XF95		692387	ELEK0741
	8.	DAF	F85, 95, CF, 95XF, XF95		1449102	ELEK0742

DAVAČI I SENZORI						
Slika	Poz.	Tip vozila	Tip motora	Dimenzije (mm)	OE broj	RAPIDEX broj
	9.	DAF	65CF, CF65, CF75, CF85		1447974	ELEK0743
	10.	MAN	M90	4,8 - 5,2 bar, M12 x 1,5	81.25520.0079	ELEK0744
	11.	MAN	G/M/F90, L/M/F2000	4,8 - 5,8 bar, M12 x 1,5	81.25520.0076	ELEK0745
	12.	MAN	M/F90, L/M/F2000	0 - 10 bar, 5,2±0,3, M12 x 1,5	81.27421.0097	MOTO0803
	13.	MAN	M/F90, F2000	4,8 - 5,2 bar, M12 x 1,5	81.25520.0117	ELEK0746
	14.	MAN	M/F90, F2000	0,3 - 0,8 bar, M12 x 1,5	81.25520.0152	HLAĐ0124
	15.	MAN	L/M/F2000	M22 x 1	81.25520.0171	ELEK0747
	16.	MAN	L/M/F2000, TGA	5,4 - 5,8 bar, M12 x 1,5	81.25520.0184	ELEK0748

DAVAČI I SENZORI						
Slika	Poz.	Tip vozila	Tip motora	Dimenzije (mm)	OE broj	RAPIDEX broj
	17.	MAN	Bus Lions (City, Classic)	0,3 - 0,8 bar, M12 x 1,5	81.25520.0167	ELEK0749
	18.	MAN	D0824, D0826, D2866, D2876	0-5 bar, 0,25±0,15, M18 x 1,5	81.27421.0109	ELEK0052
	19.	MAN	L/M/F2000, Lions, Neoplan	0-16 bar, 5,3±0,4 bar, M12 x 1,5	81.27421.0151	MOTO0804
	20.	MAN	D0226, D2566, D2866	0-5 bar, 0,25±0,15, M18 x 1,5	81.27421.0088	MOTO0805
	21.	MAN	TGA, TGL, F2000 D0826, D2066, D2866, D2876	106°C+3°C	51.27421.0151	MOTO0806
	22.	MAN	TGA, TGL, F2000 D0836, D2066, D2866, D2876		51.27421.0165	MOTO0807
	23.	MAN	F90, F2000, TGA		81.27421.0171	MOTO0808
	24.	MAN	F2000, TGA, Lions, Neoplan		81.27420.0085	MOTO0809

DAVAČI I SENZORI						
Slika	Poz.	Tip vozila	Tip motora	Dimenzije (mm)	OE broj	RAPIDEX broj
	25.	MAN	F2000, TGA, Lions, Neoplan	M14 x 1,5 100°C	51.27420.0008	MOTO0810
	26.	MAN	TGA, TGL, F2000 D0826, D2066 D2866, D2876		51.27421.0077	MOTO0811
	27.	MAN	TGA, TGL, F2000 D0826, D2066, D2866, D2876		81.27421.0077	MOTO0060
	28.	MAN	M/F90, L/M/F2000	M18 x 1,5 / M27 x 1	81.25505.0808	ELEK0750
	29.	MAN	L/M2000, TGA	M27 x 1 / M10 x 1 2 - 5 bar	81.25520.6007	ELEK0751
	30.	MAN	G90	M10 x 1	81.25520.0037	ELEK0752
	31.	MAN	M/F90, L/M/F2000		81.27120.0016	ELEK0753
	32.	MAN, MERCEDES	F90, F2000, TGA, Serija SK, MK, NG	M18 x 1,5 / M27 x 1	81.25505.0538 003 545 16 14	ELEK0754

DAVAČI I SENZORI						
Slika	Poz.	Tip vozila	Tip motora	Dimenzije (mm)	OE broj	RAPIDEX broj
	33.	MAN, MERCEDES	F90, F2000, TGA, Serija SK, MK, NG	M18 x 1,5 / M27 x 1	81.25505.0636 001 545 47 14	ELEK0755
	34.	MERCEDES	OM400-404, 420-424, 440-444	0-5 bar, M18 x 1,5	002 542 17 17	ELEK0608
	35.	MERCEDES	OM400-404, 420-424, 440-444	0-5 bar, M18 x 1,5	004 542 43 17	MOTO0812
	36.	MERCEDES	OM400-404, 420-424, 440-444	0-5 bar, M14 x 1,5	004 542 89 17	MOTO0813
	37.	MERCEDES	Actros, OM501, 502 Atego, OM906	0-5 bar, M16 x 1,5	012 542 05 17	MOTO0814
	38.	MERCEDES	Actros, OM501, 502		004 153 49 28	MOTO0815
	39.	MERCEDES	Actros, OM501, 502 Atego, OM906		000 153 99 32	MOTO0816
	40.	MERCEDES	Actros, Axor		001 545 50 09	MOTO0817

DAVAČI I SENZORI						
Slika	Poz.	Tip vozila	Tip motora	Dimenzije (mm)	OE broj	RAPIDEX broj
	41.	MERCEDES	Atego, Actros OM501, OM502, OM457 OM441LA, OM442LA	M14 x 1,5 130°C max	003 153 84 28	MOTO0818
	42.	MERCEDES	Actros, Axor, OM501, OM502	M14 x 1,5 130°C max	004 153 25 28	MOTO0819
	43.	MERCEDES	Axor, Atego, OM906	M14 x 1,5 120°C max	004 153 42 28	MOTO0820
	44.	MERCEDES	OM407, 447, 449, OM401-404, OM420-424, OM440-444	M14 x 1,5 105°C	004 542 56 17	MOTO0821
	45.	MERCEDES	OM401-404, OM420-424, OM440-444	M14 x 1,5 103°C	003 153 90 28	MOTO0822
	46.	MERCEDES	OM401-404, OM420-424, OM440-444	M14 x 1,5 100°C	002 542 73 17	MOTO0823
	47.	MERCEDES	OM403	M14 x 1,5 97°C	004 545 55 24	MOTO0824
	48.	MERCEDES	OM403	M14 x 1,5 90°C	001 542 23 17	MOTO0825

DAVAČI I SENZORI						
Slika	Poz.	Tip vozila	Tip motora	Dimenzije (mm)	OE broj	RAPIDEX broj
	49.	MERCEDES	Serija SK, MK, NG	M18 x 1,5 115±3°C	011 542 18 17	MOTO0826
	50.	MERCEDES	OM457, OM441LA, OM442LA, Actros OM501		003 153 76 28	MOTO0827
	51.	MERCEDES	OM457, OM441LA, OM442LA, Actros OM501, Axor		004 153 03 28	MOTO0828
	52.	MERCEDES	Actros, Axor		000 542 91 18	MOTO0829
	53.	MERCEDES	Actros, Axor		000 542 92 18	MOTO0830
	54.	MERCEDES	Actros, Axor		001 545 74 09	MOTO0831
	55.	MERCEDES	Actros, Axor		001 545 7309	MOTO0832
	56.	MERCEDES	Actros, Axor		012 542 1017	MOTO0833

DAVAČI I SENZORI						
Slika	Poz.	Tip vozila	Tip motora	Dimenzije (mm)	OE broj	RAPIDEX broj
	57.	MERCEDES	Serija SK, MK, NG Actros, Axor		015 542 24 17	MOTO0834
	58.	MERCEDES	Serija SK, MK, NG Actros, Axor		012 542 46 17	MOTO0835
	59.	MERCEDES	Serija SK, MK, NG Actros, Axor		015 542 27 17	MOTO0836
	60.	MERCEDES	Actros, Axor		001 545 49 09	MOTO0837
	61.	MERCEDES	Serija SK, MK, NG	M27 x 1	001 545 76 14	MOTO0838
	62.	MERCEDES	Serija SK, MK, NG	M27 x 1 / M12 x 1,5	000 545 79 09	MOTO0839
	63.	MERCEDES	Serija SK, MK, NG	M27 x 1 / M12 x 1,5	001 545 27 09	MOTO0840
	64.	MERCEDES	Serija SK, MK, NG	M27 x 1 / M 12 x 1,5	001 545 28 09	MOTO0841

1

DAVAČI I SENZORI						
Slika	Poz.	Tip vozila	Tip motora	Dimenzije (mm)	OE broj	RAPIDEX broj
	65.	MERCEDES	Serijska SK, MK, NG	M27 x 1 / M20 x 1,5	001 545 29 09	MOTO0842
	66.	MERCEDES	Serijska SK, MK, NG	M18 x 1,5 / M27 x 1	001 545 81 14	MOTO0843
	67.	MERCEDES	Serijska SK, MK, NG		006 542 88 17	MOTO0844
	68.	MERCEDES	Serijska SK, MK, NG Actros, Axor		013 542 62 17	MOTO0845
	69.	SCANIA	Serijska 2, 3, 4 DSC9, DC9, DSC12, DC12	0-10 bar, 0,7±0,15, M14 x 1,5	374338	MOTO0846
	70.	SCANIA	Serijska 2, 3, 4 DSC11, DSC14	M14 x 1,5	1 316 331	MOTO0847
	71.	SCANIA	Serijska 4, DSC9, DC9, DSC12, DC12, DSC14		1 452 862	MOTO0848

1

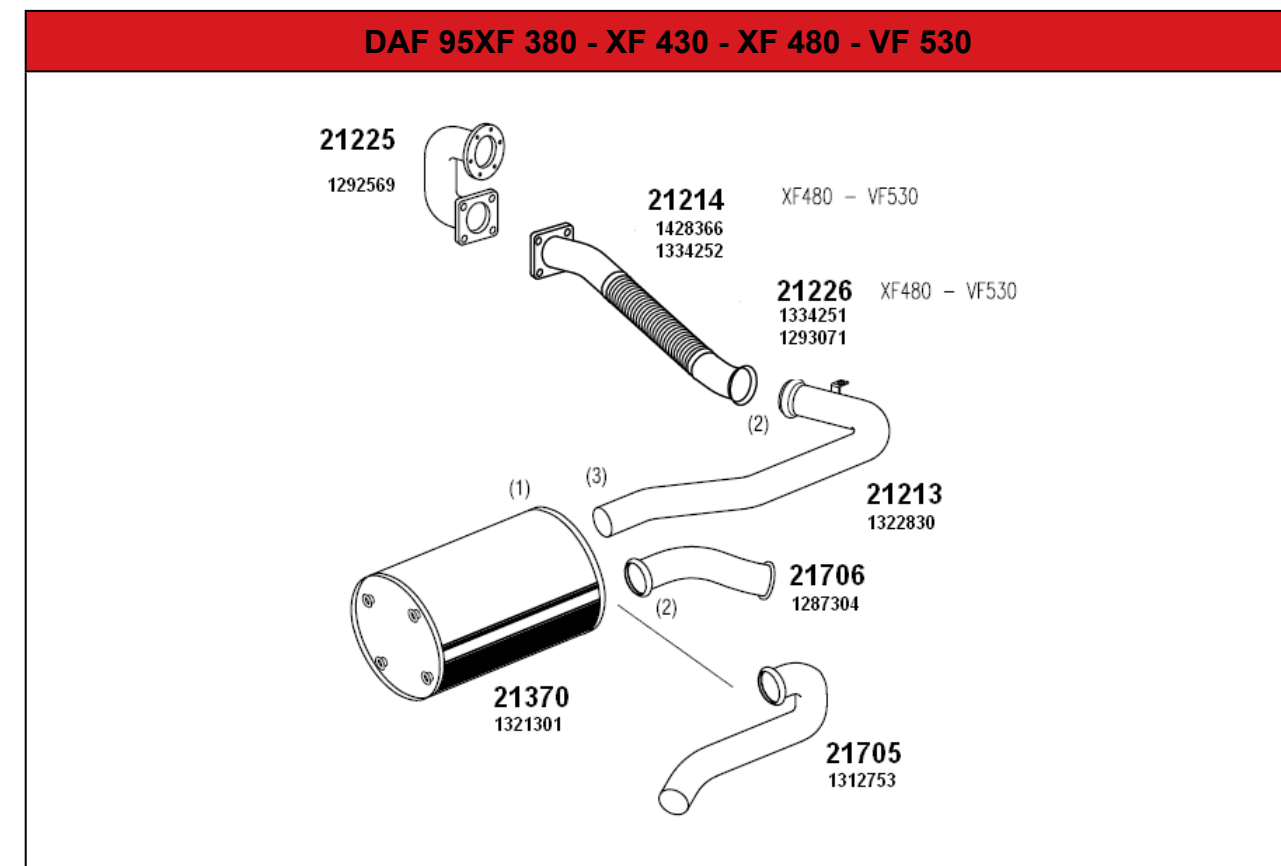

ELEMENTI IZDUVNOG SISTEMA				
Poz.	Naziv	Dinex broj	OE broj	RAPIDEX broj
1.	LONAC	21370	1321301	IZDU0036
2.	CEV	21705	1312753	IZDU0109
3.	CEV	21706	1287304	IZDU0110
4..	CEV	21213	1322830	IZDU0111
5..	CEV	21226	1334251	IZDU0112
6.	CEV	21214	1428366	IZDU0113
7.	CEV	21225	1292569	IZDU0114

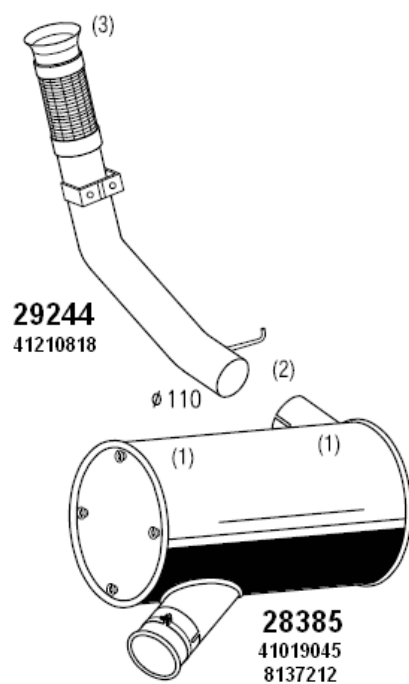
IVECO STRALIS 190S27 AD / 190S35 AD / 190S40 AD / 440S31 AT / 440S40 AS

ELEMENTI IZDUVNOG SISTEMA

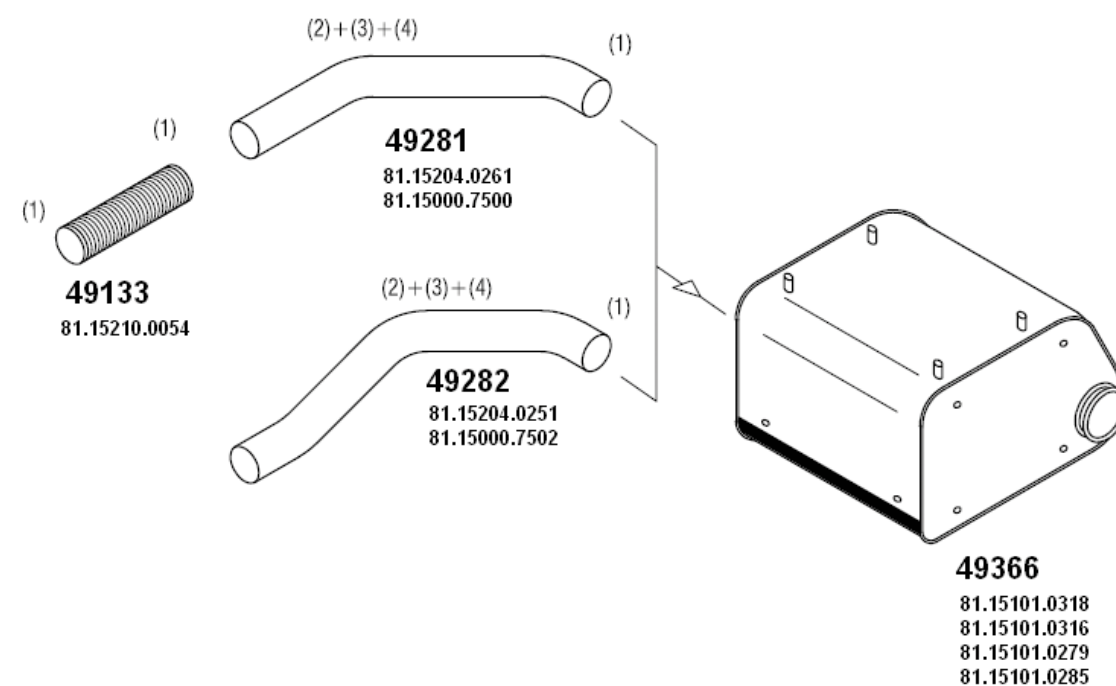
Poz.	Naziv	Dinex broj	OE broj	RAPIDEX broj
1.	LONAC	28385	41019045	IZDU0037
2.	CEV	29244	41210818	IZDU0115

MAN F2000 19 TON 4 x 2 FLL - 26 TON 6 x 2/2 FNLL

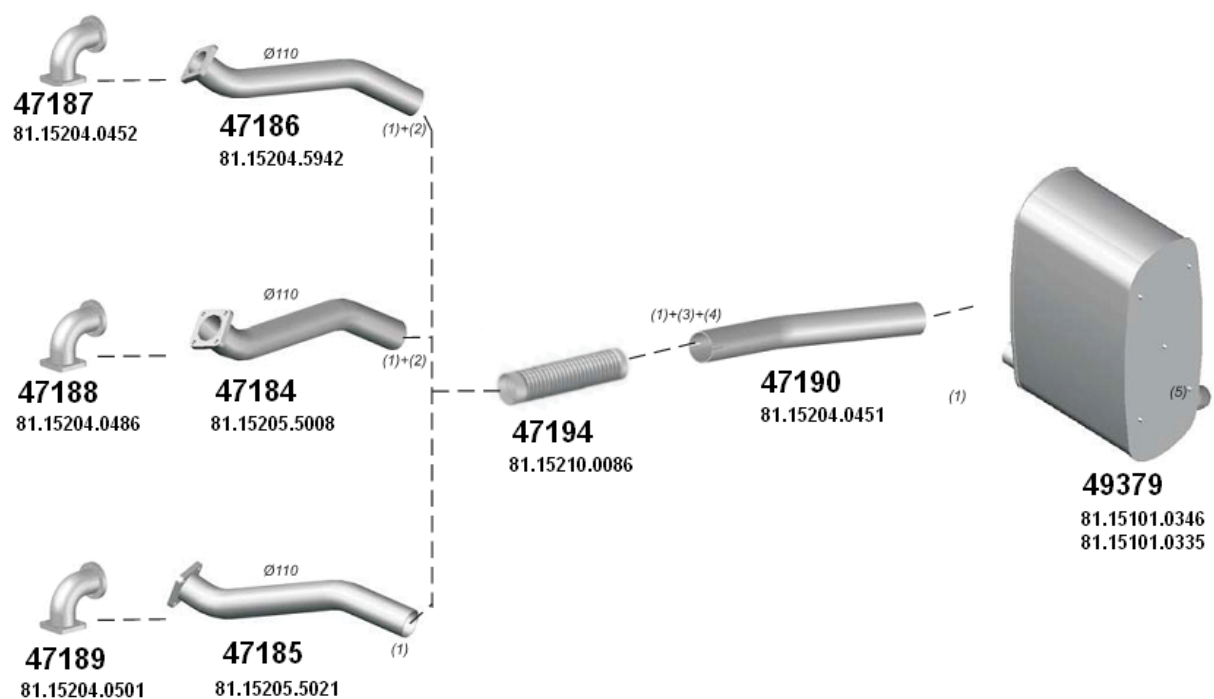
ELEMENTI IZDUVNOG SISTEMA

Poz.	Naziv	Dinex broj	OE broj	RAPIDEX broj
1.	LONAC	49366	81.15101.0318	IZDU0088
2.	CEV	49282	81.15204.0251	IZDU0116
3.	CEV	49281	81.15204.0261	IZDU0087
4..	CEV	49133	81.15210.0054	IZDU0117

MAN TGA (18t)H02, 09, 12, 51 (26t)H20, 23, (26/33t)

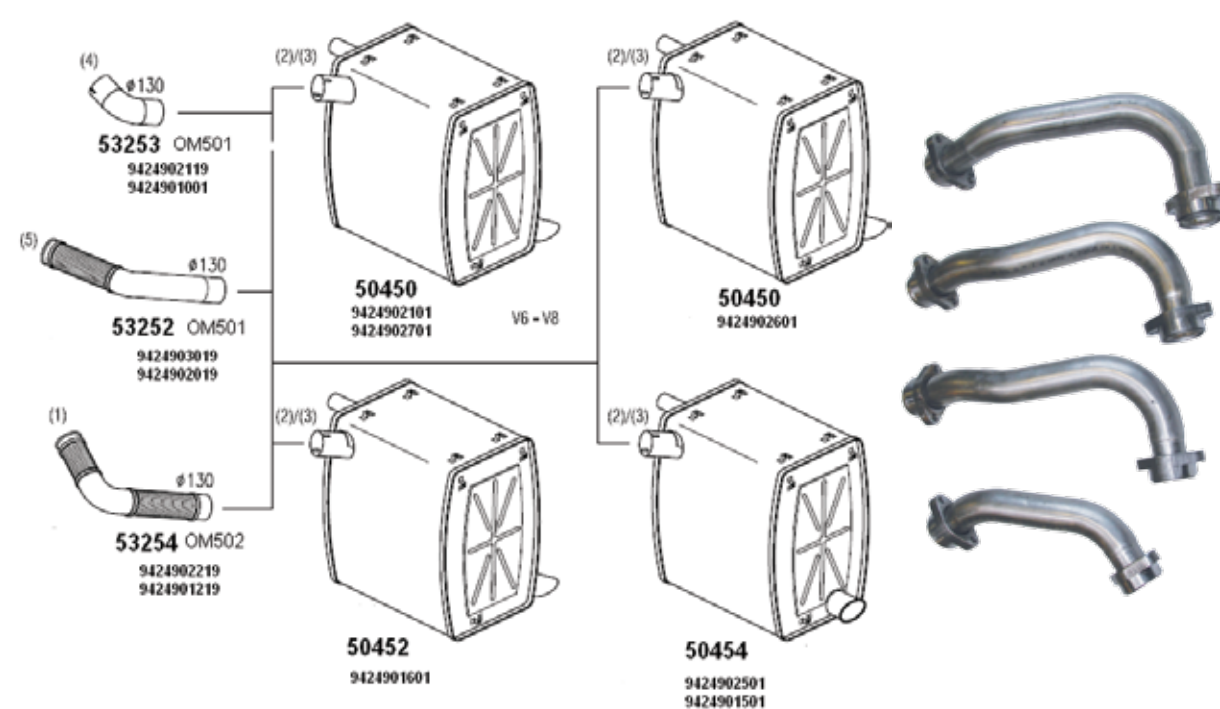
ELEMENTI IZDUVNOG SISTEMA

Poz.	Naziv	Dinex broj	OE broj	RAPIDEX broj
1.	LONAC	49379	81.15101.0346	IZDU0089
2.	CEV	47190	81.15204.0451	IZDU0047
3.	CEV	47194	81.15210.0086	IZDU0061
4.	CEV	47186	81.15204.5942	IZDU0118
5.	CEV	47184	81.15205.5008	IZDU0119
6.	CEV	47185	81.15205.5021	IZDU0120
7.	CEV	47189	81.15204.0501	IZDU0121
8.	CEV	47188	81.15204.0486	IZDU0122
9.	CEV	47187	81.15205.0452	IZDU0123

MERCEDES ACTROS

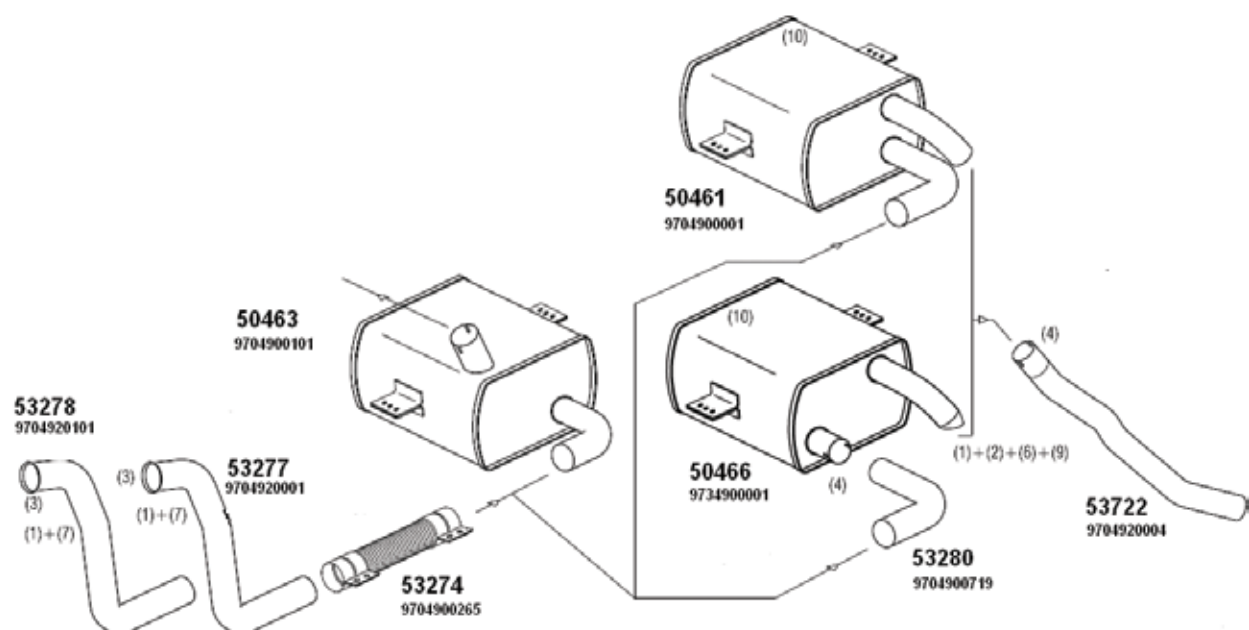
ELEMENTI IZDUVNOG SISTEMA

Poz.	Naziv	Dinex broj	OE broj	RAPIDEX broj
1.	LONAC	50450	942 490 26 01	IZDU0050
2.	LONAC	50454	942 490 25 01	IZDU0124
3.	LONAC	50452	942 490 16 01	IZDU0125
4.	CEV	53254	942 490 22 19	IZDU0080
5.	CEV	53252	942 490 30 19	IZDU0081
6.	CEV	53253	942 490 21 19	IZDU0126
7.	CEV TURBINE	53173	541 140 26 03	IZDU0045
8.	CEV TURBINE	53174	541 140 25 06	IZDU0044
9.	CEV TURBINE	53175	541 140 21 03	IZDU0043
10.	CEV TURBINE	53176	541 140 22 03	IZDU0042

MERCEDES ATEGO

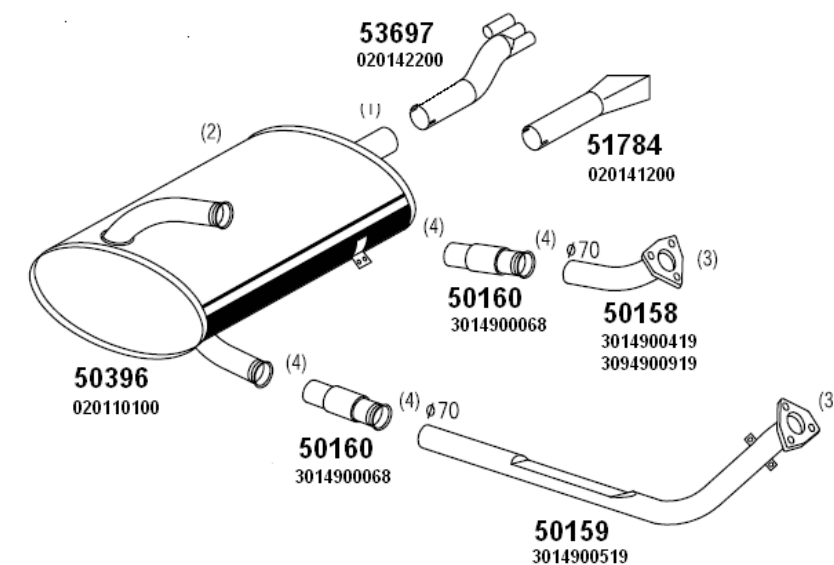
ELEMENTI IZDUVNOG SISTEMA

Poz.	Naziv	Dinex broj	OE broj	RAPIDEX broj
1.	LONAC	50461	970 490 00 01	IZDU0076
2.	LONAC	50454	973 490 00 01	IZDU0124
3.	LONAC	50463	970 490 01 01	IZDU0127
4.	CEV	53722	970 492 00 04	IZDU0128
5.	CEV	53274	970 490 02 65	IZDU0083
6.	CEV	53277	970 492 00 01	IZDU0129
7.	CEV	50463	970 490 01 01	IZDU0131
8.	CEV	53278	970 492 01 01	IZDU0130

NEOPLAN N116 SKILINER - CITYLINER - JETLINER V8

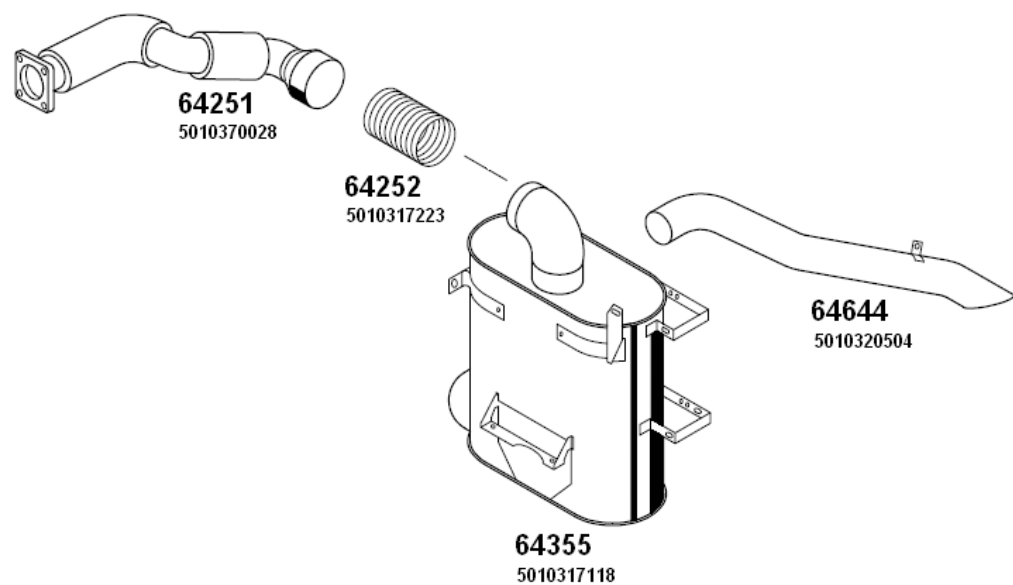
ELEMENTI IZDUVNOG SISTEMA

Poz.	Naziv	Dinex broj	OE broj	RAPIDEX broj
1.	LONAC	50396	020110100	IZDU0132
2.	CEV	50160	3014900068	IZDU0133
3.	CEV	50159	3014900519	IZDU0134
4.	CEV	50158	3014900419	IZDU0135
5.	CEV	51784	020141200	IZDU0136
6.	CEV	53697	.020142200	IZDU0137

RENAULT MAGNUM AE390 - AE430 - AE470 EURO 2

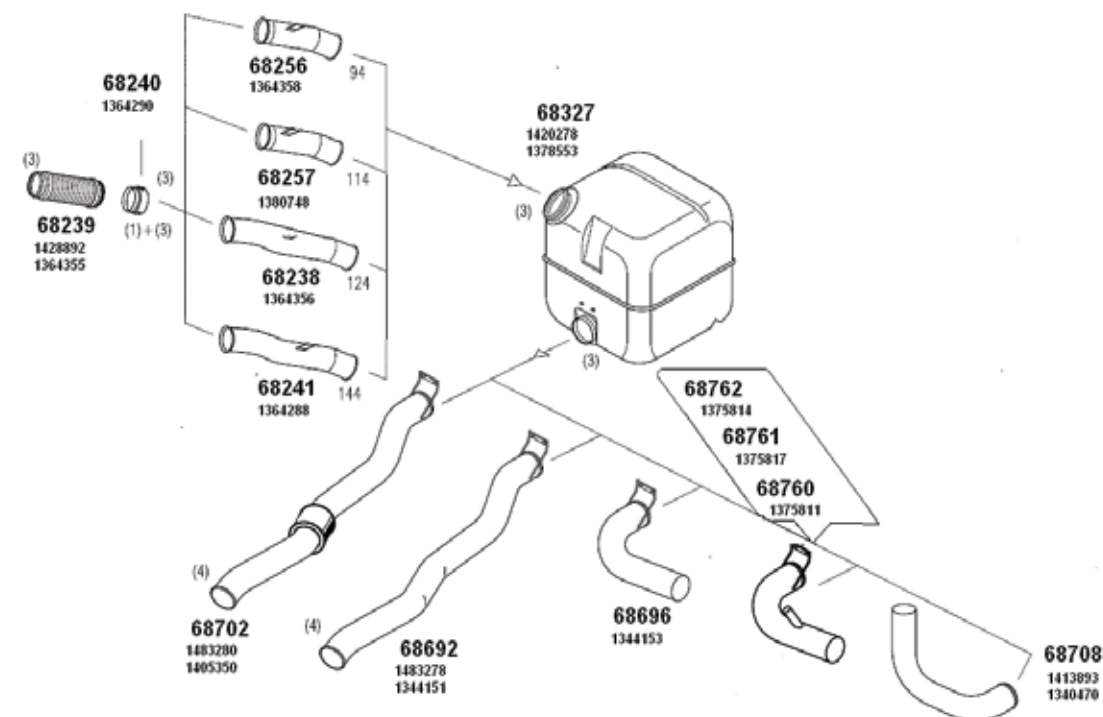
ELEMENTI IZDUVNOG SISTEMA

Poz.	Naziv	Dinex broj	OE broj	RAPIDEX broj
1.	LONAC	64355	5010317118	IZDU0138
2.	CEV	64644	5010320504	IZDU0139
3.	CEV	64252	5010317223	IZDU0140
4.	CEV	64251	5010370028	IZDU0141

SCANIA 94 D/L/C/G - 114 L/C/G - 124 L/C/G - 144 L/C/G

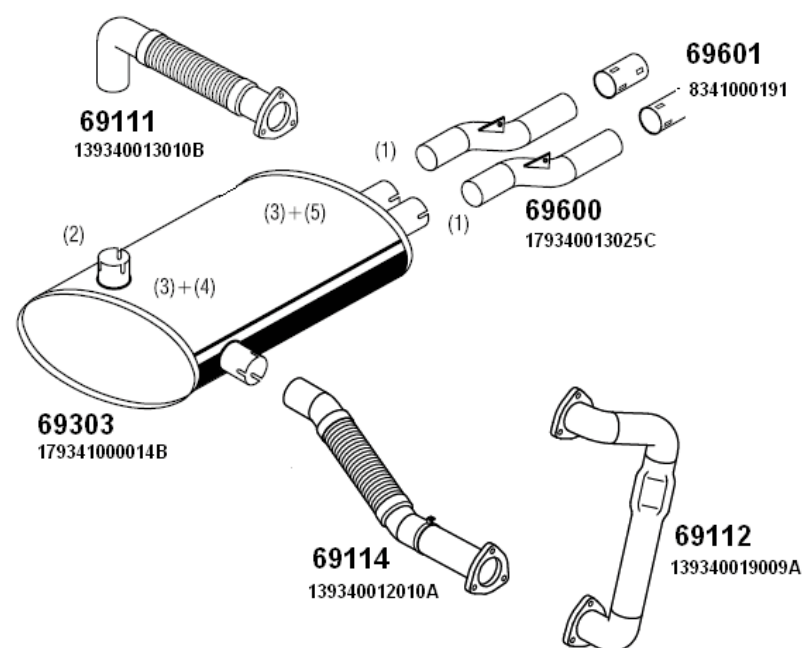
ELEMENTI IZDUVNOG SISTEMA

Poz.	Naziv	Dinex broj	OE broj	RAPIDEX broj
1.	LONAC	68327	1 420 278	IZDU0035
2.	CEV	68708	1 413 893	IZDU0142
3.	CEV	68762	1 375 814	IZDU0143
4.	CEV	68761	1 375 217	IZDU0144
5.	CEV	68760	1 375 811	IZDU0145
6.	CEV	68696	1 344 153	IZDU0146
7.	CEV	68692	1 483 278	IZDU0147
8.	CEV	68702	1 483 280	IZDU0148
9.	CEV	68241	1 364 288	IZDU0149
10.	CEV	68238	1 364 356	IZDU0150
11.	CEV	68257	1 380 748	IZDU0151
12.	CEV	68256	1 364 358	IZDU0152
13.	CEV	68239	1 428 892	IZDU0153

SETRA S213 - S214 - S215 - S216

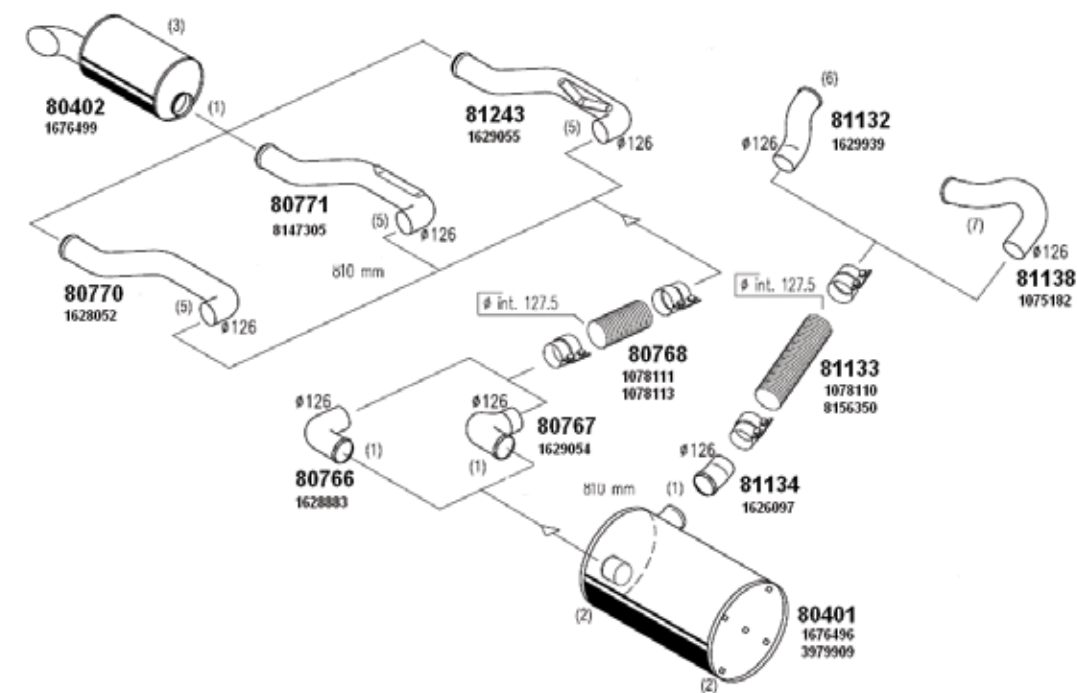
ELEMENTI IZDUVNOG SISTEMA

Poz.	Naziv	Dinex broj	OE broj	RAPIDEX broj
1.	LONAC	69303	179341000014B	IZDU0154
2.	CEV	69111	139340013010B	IZDU0155
3.	CEV	69114	139340012010A	IZDU0156
4.	CEV	69112	139340019009A	IZDU0157
5.	CEV	69600	179340013025C	IZDU0158
6.	CEV	69601	8341000191	IZDU0159

VOLVO

ELEMENTI IZDUVNOG SISTEMA

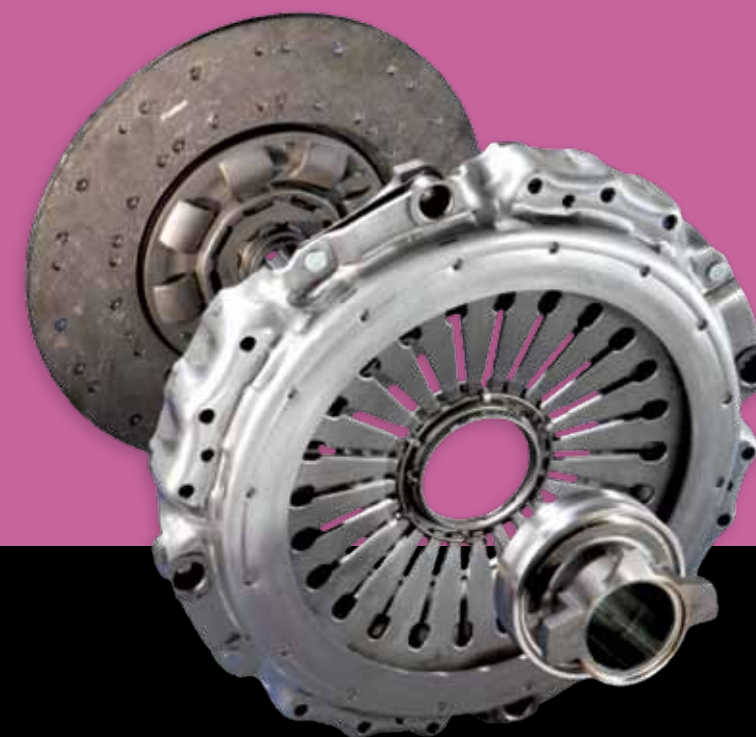
Poz.	Naziv	Dinex broj	OE broj	RAPIDEX broj
1.	LONAC	1676499	80402	IZDU0049
2.	LONAC	1676496	80401	IZDU0048
3.	CEV	1628052	80770	IZDU0160
4.	CEV	8147305	80771	IZDU0092
5.	CEV	1629055	81243	IZDU0161
6.	CEV	1628883	80766	IZDU0162
7.	CEV	1629054	80767	IZDU0090
8.	CEV	1078111	80768	IZDU0085
9.	CEV	1626097	81134	IZDU0084
10.	CEV	8156350	81133	IZDU0163
11.	CEV	1629939	81132	IZDU0086
12.	CEV	1075182	81138	IZDU0091

2.0 KVAČILO I TRANSMISIJA



2.0 KVAČILO I TRANSMISIJA

- 2.1 Setovi kvačila i elementi 116
- 2.2 Centralni ležajevi kardana 124
- 2.3 Cilindri menjača 126

[NAZAD NA GLAVNI SADRŽAJ](#)

SETOVI KVAČILA

Poz.	Tip vozila	Prečnik	Broj zuba	KBP	OE broj	RAPIDEX broj
1.	DAF95XF, XF95, CF	Ø430 mm	10	3400 122 101	1625968	MENJ0200
2.	IVECO EUROCARGO	Ø330 mm	10	3400 700 431	2996358	MENJ0228
3.	IVECO STRALIS, TRAKKER, EUROSTAR	Ø430 mm	10	3400 117 801	500335105	MENJ0237
4.	MAN L2000	Ø362 mm	10	3400 710 002	81.30005.9024	MENJ0239
5.	MAN L2000	Ø362 mm	10	3400 700 303	636302509	MENJ0291
6.	MAN L2000, M90	Ø362 mm	10	3400 121 801	81.30005.9003	MENJ0261
7.	MAN M2000	Ø395 mm	10	3400 121 701	81.30005.9006	MENJ0298
8.	MAN F90, F2000	Ø430 mm	10	3400 122 201	81.30005.9021	MENJ0184
9.	MAN F90, F2000, TGA	Ø430 mm	10	3400 700 327	81.30005.9019	MENJ0159
10.	MAN TGA	Ø430 mm	10	3400 127 401	81.30005.9022	MENJ0267
11.	MAN TGA	Ø430 mm	10	3400 700 402	82.30005.9004	MENJ0265

SETOVI KVAČILA

Poz.	Tip vozila	Prečnik	Broj zuba	KBP	OE broj	RAPIDEX broj
12.	MAN TGA	Ø430 mm	10	3400 700 404	81.30000.6572	MENJ0233
13.	MERCEDES LK, MK	Ø350 mm	10	3400 125 001	020 250 53 01	MENJ0268
14.	MERCEDES SK 1735-3550	Ø400 mm	10	3400 121 601	020 250 45 01	MENJ0142
15.	MERCEDES MK, SK	Ø430 mm	10	3400 122 601	020 250 50 01	MENJ0270
16.	MERCEDES MK, SK	Ø430 mm	10	3400 700 411	020 250 52 01	MENJ0221
17.	MERCEDES ATEGO	Ø362 mm	18	3400 127 701	018 250 94 01	MENJ0269
18.	MERCEDES ATEGO	Ø395 mm	18	3400 121 201	018 250 95 01	MENJ0285
19.	MERCEDES ATEGO, AXOR	Ø395 mm	18	3400 121 301	019 250 65 01	MENJ0250
20.	MERCEDES ACTROS, MP2	Ø400 mm dupli	18	3400 121 501	022 250 48 01	MENJ0185
21.	MERCEDES ACTROS	Ø430 mm	18	3400 122 701	018 250 98 01	MENJ0195
22.	MERCEDES ACTROS	Ø430 mm	18	3400 122 801	022 250 57 01	MENJ0263
23.	MERCEDES ACTROS, MP2	Ø430 mm	18	3400 700 416	022 250 33 01	MENJ0131
24.	RENAULT KERAX, MAGNUM, PREMIUM	Ø430 mm	20	3400 700 408	5001 486 489	MENJ0082
25.	RENAULT KERAX, MAGNUM, PREMIUM	Ø430 mm	10	3400 700 334	5001 866 891	MENJ0149
26.	SCANIA SERIJA 4	Ø430 mm	24	3400 122 001	643308709	MENJ0205
27.	SCANIA SERIJA 4	Ø430 mm	24	3400 700 352	71525	MENJ0199
28.	VOLVO FH12, FM	Ø380 mm	10	3400 700 325	85000310	MENJ0216
29.	VOLVO FH12, FM12	Ø380 mm	10	3400 700 326	85000309	MENJ0213
30.	VOLVO FH12, FL12	Ø380 mm	10	3400 700 426	85000310	MENJ0206
31.	VOLVO FH12, FM7, FM12	Ø430 mm	10	3400 127 101	8113811	MENJ0204
32.	VOLVO FH, FM	Ø430 mm	24	3400 700 342	85000274	MENJ0244
33.	VOLVO FH12, FM9, FM12	Ø430 mm	24	3400 700 343	85000268	MENJ0198
34.	VOLVO FH12	Ø430 mm	24	3400 700 350	85000277	MENJ0214

KORPE KVAČILA

Poz.	Tip vozila	Prečnik	Tip	KBP	OE broj	RAPIDEX broj
1.	DAF	Ø430 mm	GMF 430	3482 119 031	1310896	KVAC0176
2.	MAN	Ø310 mm	MFZ 310	3482 102 031	81.30305.0187	KVAC0171
3.	MAN	Ø400 mm	MFZ2/400X	3488 017 447	81.30305.0231	MENJ0188
4.	MAN	Ø420 mm	GF 420	1882 330 032	81.30305.0083	KVAC0175
5.	MAN	Ø430 mm	MFZ 430	3482 000 361	81.30305.0230	KVAC0173
6.	MERCEDES	Ø280 mm	MFZ 280	3482 054 131	003 250 93 04	KVAC0170
7.	MERCEDES	Ø310 mm	MF 310	3482 008 038	003 250 98 04	MENJ0251
8.	MERCEDES	Ø380 mm	GF2/380	1888 055 041	004 250 98 04	KVAC0168
9.	MERCEDES	Ø395 mm	MF 395	3482 000 464	021 250 27 01	KVAC0025
10.	MERCEDES	Ø430 mm	MFZ 430	3482 081 232	005 250 83 04	KVAC0011
11.	MERCEDES	Ø430 mm	MFZ 430	3482 081 231	005 250 84 04	MENJ0186
12.	MERCEDES	Ø430 mm	MFZ430	3483 030 031	005 250 93 04	KVAC0174
13.	MERCEDES	Ø430 mm	MFZ 430	3483 030 032	008 250 44 04	KVAC0014
14.	RENAULT	Ø430 mm	MFZ 430	3482 083 252	5010 244 203	KVAC0169
15.	SCANIA	Ø430 mm	MFZ 430	3482 083 150	1 341 687	KVAC0172

KORPE KVAČILA

Poz.	Tip vozila	Prečnik	Tip	KBP	OE broj	RAPIDEX broj
16.	SCANIA	Ø430 mm	MFZ 430	3482 083 039	571220	MENJ0215
17.	VOLVO	Ø350 mm	GF2/350	1882 250 143	1527474	MENJ0227
18.	VOLVO	Ø380 mm	M 380	3482 602 002	6795044	MENJ0136
19.	VOLVO	Ø400 mm	GMFZ2/400	3482 110 031	1669137	KVAC0003
20.	VOLVO	Ø430 mm	MFZ 430	3483 034 032	1668615	MENJ0005
21.	VOLVO	Ø430 mm	MFZ 430	3483 034 033	3192210	MENJ0260

LAMELE KVAČILA

Poz.	Tip vozila	Prečnik	Broj zuba	KBP	OE broj	RAPIDEX broj
1.	MERCEDES BUS	Ø380 mm	10	1861 219 157	003 250 51 03	KVAC0077
2.	MERCEDES LP, NG	Ø310 mm	10	1861 303 246	003 250 86 03	KVAC0066
3.	MERCEDES OM 352	Ø330 mm	10	1861 571 236	011 250 74 03	KVAC0109
4.	MERCEDES SK, NG	Ø420 mm	10	1861 760 034	008 250 74 03	KVAC0067
5.	MERCEDES NG	Ø380 mm	10	1862 135 035	007 250 47 03	KVAC0065
6.	MERCEDES NG	Ø380 mm	10	1862 138 032	010 250 78 03	KVAC0064
7.	MAN F2000, TGA	Ø400 mm	10	1862 539 031	81.30301.0539	MENJ0187
8.	MERCEDES SK	Ø380 mm	10	1878 000 105	006 250 90 03	KVAC0116
9.	VOLVO FH16	Ø400 mm	10	1878 000 625	340001720	KVAC0001

LAMELE KVAČILA

Poz.	Tip vozila	Prečnik	Broj zuba	KBP	OE broj	RAPIDEX broj
10.	RENAULT MAGNUM, VOLVO FH12	Ø430 mm	24	1878 000 634	8172802	KVAC0057
11.	VOLVO F7	Ø350 mm	10	1878 001 079	8112168	KVAC0153
12.	VOLVO F7	Ø350 mm	10	1878 001 083	3018130	KVAC0146
13.	VOLVO FH16	Ø400 mm	10	1878 002 458	1669138	KVAC0002
14.	MAN F2000, TGA, TGS, STEYR	Ø430 mm	10	1878 002 643	81.30301.0539	MENJ0097
15.	SCANIA SERIJA 3, 4	Ø430 mm	24	1878 003 066	1749123	KVAC0081
16.	RENAULT KERAX, MAGNUM, PREMIUM	Ø430 mm	20	1878 020 241	5000677007	KVAC0053
17.	MAN TGA, NEOPLAN	Ø430 mm	10	1878 038 041	81.30301.0446	MENJ0161
18.	RENAULT, IVECO	Ø430 mm	16	1878 049 041	5000677216	KVAC0046
19.	SCANIA SERIJA 2, 3	Ø430 mm	22	1878 062 944	364378	KVAC0112
20.	MERCEDES TRAVEGO, TOURISMO	Ø430 mm	10	1878 080 034	018 250 94 03	KVAC0019
21.	MAN F90, F2000	Ø430 mm	10	1878 080 035	81.30301.0502	MENJ0218
22.	MAN TGA, MERCEDES SK	Ø430 mm	10	1878 080 037	81.30301.9506	KVAC0114
23.	IVECO EUROTECH, EUROSTAR, STRALIS	Ø430 mm	10	1878 085 741	500372079	MENJ0240
24.	MERCEDES SK	Ø400 mm	10	1878 634 023	010 250 92 03	KVAC0177
25.	MERCEDES ACTROS	Ø430 mm	18	1878 634 024	015 250 7703	KVAC0007
26.	MAN F90, F2000	Ø430 mm	10	1878 634 028	81.30301.9569	MENJ0243

POTISNI LEŽAJEVI

Poz.	Tip vozila	Tip	KBP	OE broj	RAPIDEX broj
1.	DAF 85, 95, MAN F2000	KZISZ-5	3151 182 233	1780332	KVAC0094
2.	MAN L2000	KZIS-3	3151 199 001	81.30550.0044	KVAC0163
3.	MAN L2000	HHISZ-3	3182 005 231	ZA 4901.8.1	MENJ0194
4.	MAN	KZI-4.5	3151 067 031	81.30550.0043	KVAC0167
5.	MAN	KZIZ-5	3151 000 335	81.30550.0113	MENJ0232
6.	MAN TGA, F2000	KZISZ-5	3151 000 034	81.30550.0110	MENJ0282
7.	MAN TGA, IVECO	KZISZ-5	3151 000 144	42556650	KVAC0062
8.	MAN BUS	KZI-4.5	3151 058 001	81.30550.0052	KVAC0164
9.	MERCEDES NG	KZI-4.5	3151 108 031	000 250 75 15	KVAC0165
10.	MERCEDES NG	KZIS-4	3151 000 375	000 250 77 15	KVAC0162
11.	MERCEDES MK, SK, O303	KZIZ-5	3151 245 032	001 250 97 15	KVAC0166

POTISNI LEŽAJEVI

Poz.	Tip vozila	Tip	KBP	OE broj	RAPIDEX broj
12.	MERCEDES NG, SK	KZIZ-5	3151 246 031	001 250 98 15	KVAC0010
13.	MERCEDES ATEGO	HHIS-3	3182 998 501	ZA 5108A1	MENJ0246
14.	MERCEDES ATEGO	HHIS-3	ZA 5109.3.2	002 250 76 15	MENJ0144
15.	MERCEDES	KZI-4.5	3151 090 131	000 250 67 15	KVAC0090
16.	MERCEDES ACTROS	KZISZ-5	3100 002 255	002 250 98 15	MENJ0192
17.	RENAULT	KZISZ-5	3151 250 231	5010244017	MENJ0126
18.	RENAULT KERAX	KZISZ-5	3151 000 404	5010244086	KVAC0052
19.	SCANIA	KZIZ-5	3100 008 201	1407430	MENJ0222
20.	SCANIA	HHISZ-4	3182 009 938	1522377	MENJ0238
21.	VOLVO	KZIZ-5	3100 026 432	1672944	MENJ0207
22.	VOLVO	KZA-4	3151 600 533	1655288	MENJ0266
23.	VOLVO FH12, 16	KZISZ-5	3100 026 431	3192218	KVAC0089
24.	VOLVO FH12, 16	KZISZ-5	3100 026 434	20569153	KVAC0088

ZAMAJCI

Poz.	Tip vozila	Prečnik (mm)	KBP/OE broj	RAPIDEX broj
1.	MAN F90	380	51.0231.7290	MOTO0386
2.	MAN TGA	430	3421 601 044 / 51.02301.6034	MOTO0319
3.	MAN TGA	430	3421 601 046 / 51.02301.5209	MOTO0098
4.	MAN TGA	430	3421 601 047	MOTO0256
5.	MAN, MERCEDES	420	51.02301.0307	MOTO0397
6.	MERCEDES SPRINTER	240	611 030 20 05	KVAC0045
7.	MERCEDES LK	310	3421 601 003	MOTO0370
8.	MERCEDES VARIO	360	3421 601 052	MOTO0974
9.	MERCEDES MK, NG	430	3421 601 011	MOTO0668
10.	MERCEDES ACTROS	430	3421 601 016	MOTO0527
11.	MERCEDES AXOR	430	3421 601 050	MOTO0973
12.	MERCEDES TOURISMO, NEOPLAN	430	6594 000 007	MOTO0003
13.	MERCEDES O303, O304	430	3421 301 012	MOTO0572
14.	RENAULT MAGNUM	430	3421 601 023	MOTO0972
15.	RENAULT	430	3421 601 036	MOTO0971
16.	SCANIA SERIJA 3, 4	430	3421 601 020	MOTO0542
17.	SCANIA BUS	430	306993	MOTO0575





CENTRALNI LEŽAJEVI KARDANA						
Poz.	Tip vozila	Ø (mm)	B (mm)	L (mm)	OE broj	RAPIDEX broj
1.	DAF 65/75/85/95/95XF	55	18	190	1298157	MENJ0309
2.	DAF 85CF/95XF/95XF 530, F85/95	70	20	220	1235569	MENJ0310
3.	IVECO EUROTECH, EUROSTAR, EUROTRAKKER, EUROTECH/STAR CURSOR, STRALIS	70	17	220	42541437	MENJ0311

CENTRALNI LEŽAJEVI KARDANA						
Poz.	Tip vozila	Ø (mm)	B (mm)	L (mm)	OE broj	RAPIDEX broj
5.	IVECO TURBOTECH, EUROTECH, EUROSTAR, EUROTRAKKER, EUROTRAKKER CURSOR	60	37	220	42536961	MENJ0313
6.	MAN TGA	85	13	220	81.39410.6031	MENJ0308
7.	MAN TGA	75	20	230	81.39410.6020	MENJ0125
8.	MAN TGA	75	20	220		MENJ0124
9.	MAN F2000, F90, L2000, M2000, M90, TGA	65	23	230	81.39410.6019 81.39410.6017 81.39410.6013	MENJ0067
10.	MERCEDES SPRINTER	45	18	194	901 411 03 12	MENJ0314
11.	MERCEDES ATEGO, LK/LN2, NG, T2/LN1	45	19	191	381 410 15 22 381 410 02 22 381 410 12 22	MENJ0297
12.	MERCEDES ATEGO, AXOR, LK/LN2, LK, NG, SK	55	18	191	385 410 09 22 385 410 01 10 973 410 00 22	MENJ0276
13.	MERCEDES ATEGO, ACTROS	55	23	-	973 411 0012	MENJ0045
14.	MERCEDES ATEGO, ATEGO II, AXOR II, MK, NG, SK	60	22	246	654 410 00 22 389 410 02 22 389 410 01 22	MENJ0315
15.	MERCEDES ATEGO, AXOR II, ACTROS	70	20	246	655 410 00 22 620 410 00 10 395 410 00 22	MENJ0262
16.	MERCEDES ACTROS, ACTROS MP2	70	20	-	656 411 00 12	MENJ0071
17.	RENAULT R370, R390, R420	60	36	200	5000819211	MENJ0316
18.	SCANIA 93,112,113,143	60/82	22	-	294 270	MENJ0317
19.	SCANIA 93,112,113,143	60/87	22	-	1 113 031	MENJ0318
20.	VOLVO F10, F12, FL10, FH12, FH16	70	21	-	8 171 366 263567	MENJ0319
21.	VOLVO FM7, FM9, FM10, FM12, FH12, FH16	70	15	220	20471428 1068222	MENJ0320



CILINDRI MENJAČA					
Poz.	Tip vozila	Naziv	KBP	OE broj	RAPIDEX broj
1.	BOVA	BIRAČ BRZINA	626446AM	244863	MENJ0335
2.	BOVA	BIRAČ BRZINA	627307AM	244869	MENJ0336
3.	BOVA	CILINDAR MENJAČA	626447AM	252236	MENJ0337
4.	BOVA	CILINDAR MENJAČA	626448AM	252237	MENJ0338
5.	BOVA	CILINDAR MENJAČA	627132AM	259366	MENJ0339
6.	DAF	BIRAČ BRZINA	626260AM	1321160	MENJ0075
7.	DAF	BIRAČ BRZINA	626261AM	1321161	MENJ0241
8.	DAF	CILINDAR MENJAČA	625942AM	1306841	MENJ0076

CILINDRI MENJAČA					
Poz.	Tip vozila	Naziv	KBP	OE broj	RAPIDEX broj
9.	DAF	CILINDAR MENJAČA	625944AM	1306842	MENJ0340
10.	MAN	BIRAČ BRZINA	627496AM	81.30605.6111	MENJ0074
11.	MAN	CILINDAR MENJAČA	626998AM	81.32655.6115	MENJ0341
12.	MAN	CILINDAR MENJAČA	629218AM	81.32655.6181	MENJ0072
13.	MAN	CILINDAR MENJAČA	629219AM	81.32655.6182	MENJ0073
14.	MERCEDES	BIRAČ BRZINA	626321AM	000 260 40 98	MENJ0284
15.	MERCEDES	BIRAČ BRZINA	626661AM	000 260 41 98	MENJ0152
16.	MERCEDES	BIRAČ BRZINA	626662AM	000 260 42 98	MENJ0153
17.	MERCEDES	BIRAČ BRZINA	629582AM	000 260 59 98	MENJ0323
18.	MERCEDES	BIRAČ BRZINA	629862AM	000 260 60 98	MENJ0177
19.	MERCEDES	BIRAČ BRZINA	630388AM	000 260 61 98	MENJ0342
20.	MERCEDES	CILINDAR MENJAČA	626156AM	001 260 25 63	MENJ0078
21.	MERCEDES	CILINDAR MENJAČA	626597AM	001 260 34 63	MENJ0123
22.	MERCEDES	CILINDAR MENJAČA	626664AM	001 260 33 63	MENJ0158
23.	MERCEDES	CILINDAR MENJAČA	627494AM	001 260 59 63	MENJ0094
24.	MERCEDES	CILINDAR MENJAČA	629137AM	001 260 88 63	MENJ0092
25.	MERCEDES	CILINDAR MENJAČA	629138AM	001 260 91 63	MENJ0349
26.	MERCEDES	CILINDAR MENJAČA	629139AM	001 260 96 63	MENJ0344
27.	MERCEDES	CILINDAR MENJAČA	629303AM	001 260 97 63	MENJ0093
28.	MERCEDES	CILINDAR MENJAČA	629614AM	002 260 06 53	MENJ0345
29.	MERCEDES	CILINDAR MENJAČA	629920AM	002 260 16 53	MENJ0347
30.	MERCEDES	CILINDAR MENJAČA	629978AM	000 260 57 98	MENJ0347
31.	MERCEDES	CILINDAR MENJAČA	629979AM	000 260 58 98	MENJ0348

3.0 KOČIONA PNEUMATIKA I HIDRAULIKA



3.0 KOČIONA PNEUMATIKA I HIDRAULIKA

3.1	Kompresori i delovi	130
3.2	Isušivači vazduha i filteri	133
3.3	Ventili kočionog sistema	135
3.4	Ventili ogibljenja	148
3.5	Cilindri tristop i membranski	154
3.6	Ventili ABS, EBS i ECAS	157
3.7	Elektronika ABS, EBS i ECAS	161
3.8	Senzori	162
3.9	Cilindri kvačila	165
3.10	Pribor kočionog sistema	172
3.11	Setovi ABS, EBS i WABCO dijagnostika	179

[NAZAD NA GLAVNI SADRŽAJ](#)



KOMPRESORI				
Poz.	WABCO broj	Tip vozila / Opis	OE broj	RAPIDEX broj
1.	411 015 807 0	IVECO	0123 1528	KOCN0698
2.	411 052 300 0	DAF	1505906	KOCN1210
3.	411 141 000 0	ISUZU, DAF	1518577R	KOCN1514
4.	411 141 818 0	MERCEDES 159 cm ³	004 131 58 01	KOCN1513
5.	411 142 818 0	MERCEDES	004 131 59 01	KOCN1515
6.	411 143 805 0	DEUTZ, IVECO, TAM	1173860	KOCN1264
7.	411 145 512 0	MAN	51.54101.7229	KOCN0023
8.	411 147 062 0	MAN F90		KOCN1146
9.	411 151 008 0	MERCEDES ATEGO		KOCN0698
10.	411 154 003 0	MERCEDES	906 130 42 15	KOCN0078
11.	412 352 003 0	MAN	51.54100.7005	KOCN0456

KOMPRESORI				
Poz.	WABCO broj	Tip vozila / Opis	OE broj	RAPIDEX broj
12.	412 352 014 0	MERCEDES	457 130 24 15	KOCN1215
13.	412 442 000 0	RVI, DAF	5010550086	KOCN0361
14.	412 704 008 0	VOLVO	85000396	KOCN0360
15.	412 704 014 0	VOLVO II FH	20842990	KOCN0062
16.	911 003 001 0	DAF	1519074	KOCN1510
17.	911 004 851 0	IVECO	1908478	KOCN1511
18.	911 145 060 0	IVECO	99436216	KOCN1516
19.	911 145 560 0	IVECO	500310905	KOCN1195
20.	911 504 052 0	DAF - DVOCILINDRIČNI	1373081R	KOCN1137
21.	911 504 060 0	DAF - DVOCILINDRIČNI	1373426R	KOCN1066
22.	911 504 504 0	DAF - DVOCILINDRIČNI	1604420	KOCN1512
23.	911 504 506 0	DAF - DVOCILINDRIČNI	1736785	KOCN0606
24.	911 505 150 0	VOLVO	5003460	KOCN1226
25.	911 505 151 0	VOLVO	8112426	KOCN1223
26.	ACX 83 D	IVECO	500310903	KOCN1517
27.	LP 4845	RENAULT	5010195545	KOCN1219
28.	LP 4857	IVECO STRALIS	41211339	KOCN0811
29.	LP 4967	VOLVO BUS	9521675	KOCN1038
30.	LP 4974	VOLVO	3987602	KOCN1053



GLAVE KOMPRESORA

Poz.	WABCO broj	Tip vozila / Opis	Aparat / OE broj	RAPIDEX broj
1.	411 154 001 2	MERCEDES AXOR	411 154 000 0	KOCN0765
2.	411 999 801 2	MERCEDES NG	000 130 26 81	KOCN1519
3.	411 999 807 2	MAN F2000	51.54114.6045	KOCN1157
4.	412 090 803 2	MAN TGA	51.54114.6081	KOCN1214
5.	412 090 920 2	MAN TGA		KOCN1518
6.	412 352 924 2	MAN TGL	412 352 003 0	KOCN0257
7.	412 442 000 2	RENAULT RVI	5001859253	KOCN0209
8.	412 704 923 2	VOLVO FH	412 704 008 0	KOCN0016
9.	412 704 932 2	VOLVO FH II	412 704 014 0	KOCN0024
10.	412 704 933 2	VOLVO FH	412 704 008 0	KOCN0061
11.	911 145 803 2	MERCEDES, FAP		KOCN1214
12.	911 503 805 2	DAF	911 504 060 0	KOCN0489
13.	911 504 650 2	DAF	513821	KOCN0740
14.	911 504 920 2	DAF XF	911 504 504 0	KOCN0626
15.	911 505 804 2	VOLVO	3094622	KOCN0462



ISUŠIVAČI VAZDUHA

Poz.	WABCO broj	Tip vozila / Opis	OE broj	RAPIDEX broj
1.	432 410 021 0	9,5 Bar	4207 9486	KOCN1545
2.	432 410 034 0	UNIVERZALAN / 12,5 bar		KOCN0844
3.	432 410 075 0	11 Bar	1505220	KOCN0725
4.	432 410 102 0	UNIVERZALAN / 8,1 bar		KOCN1546
5.	432 410 104 0	8,1 bar	8285537000	KOCN0029
6.	432 410 127 0	UNIVERZALAN / 8,1 bar		KOCN0103
7.	432 410 250 0	10 bar	1518682R	KOCN1115
8.	432 415 016 0	11 bar	1518687	KOCN0338
9.	432 421 008 0	BEZ REDUCIRA VAZDUHA	001 431 22 15	KOCN1544
10.	432 425 101 0	VOLVO / ECAD		KOCN1548
11.	432 431 002 0	DUPLI / Pmax = 13 bar		KOCN1547
12.	432 432 002 0	10 bar	81.52102.6095	KOCN0589
13.	432 432 199 0	UNIVERZALAN / 10 bar		KOCN0707
14.		MAN TGA „ECAM“	81.52108.6026	KOCN1334

ISUŠIVAČI VAZDUHA				
Poz.	KBP	Tip vozila / Opis	OE broj	RAPIDEX broj
15.	932 400 006 0	12,5 bar	000 430 30 15	KOCN0525
16.	932 400 024 0	12,5 bar	000 430 30 15	KOCN0254
17.	932 500 007 0	MERCEDES ACTROS / APU 12,5 bar	001 431 82 15	KOCN1542
18.	932 500 014 0	MERCEDES ACTROS / APU 12,5 bar	002 431 07 15	KOCN1543
19.	ZB 4593	IVECO / APU 12,5 bar AE4502+LA8125		KOCN0726



FILTERI ISUŠIVAČA VAZDUHA				
Poz.	KBP	Tip vozila	Opis	RAPIDEX broj
1.	432 410 220 2	MERCEDES UNIMOG	Pmax = 20 bar, M42 x 1,5 mm	KOCN0463
2.	432 410 222 0	UNIVERZALNI	FILTER ULOŽAK ISUŠIVAČA VAZDUHA	KOCN0894
3.	432 410 927 2	SCANIA	G 1 1/4"	KOCN1030
4.	432 901 223 2	UNIVERZALNI	NOVI TIP, ABSORBUJE ULJE, M39 x 1,5 mm	KOCN0923
5.	432 901 228 2	SCANIA	PROTECTOR, G 1 1/4"	FILT0207
6.	T350W	VOLVO SCANIA	PLASTIČNI	FILT0304
7.	432 410 244 2	UNIVERZALNI	ASP - +	KOCN1768



KOMBINOVANI REDUKCIONI VENTILI					
Poz.	WABCO broj	Tip vozila	Opis	OE broj	RAPIDEX broj
1.	975 303 220 0	MAN L2000	16 bar	1505483R	KOCN1601
2.	975 303 473 0	MERCEDES	8,1 bar	002 431 83 06	KOCN1358
3.	975 303 474 0	MERCEDES	8,1 bar sa isušivačem	002 431 52 06	KOCN1341
4.	975 303 503 0	MERCEDES	10 bar	001 431 65 06	KOCN1602
5.	975 303 504 0	MERCEDES	10bar	002 431 47 06	KOCN1194

REPARACIONI SET KOMBINOVANOG REDUKCIONOG VENTILA				
Poz.	WABCO broj	Primena u aparatu	OE broj	RAPIDEX broj
1.	975 300 000 2	975 303 ...	000 430 11 07	KOCN1338
2.	975 303 001 2	975 303 ...	82 52101 6019	KOCN1245



ČETVOROKRUŽNI / ŠESTOKRUŽNI ZAŠTITNI VENTILI

Poz.	KBP	Opis	RAPIDEX broj
1.	934 702 040 0	M22/M16, MAX 10 bar, 6/5 bar	KOCN1611
2.	934 702 041 0	M22/M16, MAX 10 bar, 7/6,5 bar	KOCN1121
3.	934 702 221 0	M22/M16, MAX 20 bar, 7 bar	KOCN1339
4.	934 702 250 0	M22/M16, MAX 20 bar, 7 bar	KOCN1612
5.	934 702 260 0	M22, MAX 20 bar, VOSS 7 bar	KOCN1143
6.	934 702 322 0	M22/M16, MAX 20 bar, 7 bar	KOCN1613
7.	934 705 005 0	MERCEDES ACTROS ZAAPU - 003 431 54 06	KOCN1162
8.	934 714 119 0	M22/M16, MAX 13 bar, 7,5 bar	KOCN1114
9.	934 714 211 0	M22/M16, MAX 13 bar, 7,4 bar	KOCN1496
10.	934 714 740 0	VOLVO, MAX 23 bar	KOCN0080
11.	AE 4502	IVECO	KOCN0945
12.	AE 4516	IVECO	KOCN0596
13.	AE 4528	DAF	KOCN0139



VENTILI RELEJNI

Poz.	KBP	Tip vozila	OE broj	RAPIDEX broj
1.	473 017 000 0	MERCEDES, FAP, IVEO	001 429 21 44	KOCN1365
2.	973 001 010 0	MERCEDES, MAN	000 429 65 44	KOCN1354
3.	973 001 020 0	MERCEDES, MAN, FAP	000 429 30 44	KOCN1178
4.	973 006 001 0	MERCEDES ACTROS, MAN TGA	004 429 06 44	KOCN1229
5.	973 011 000 0	DAF, SCANIA, VOLVO	1 082 666	KOCN1754
6.	973 011 001 0	MAN F2000	81.52116.6070	KOCN0549
7.	973 011 050 0	DAF, SCANIA	1 342 598	KOCN0566
8.	973 011 201 0	KRONE, KÖGEL	5818121	KOCN0786
9.	973 011 203 0	IVECO	41025604	KOCN0870
10.	973 011 205 0	DAF	1302103	KOCN1755
11.	AC 574 AX Y	MAN, IVECO	41031426	KOCN1052



VENTILI OGRANIČENJA PRITISKA

Poz.	WABCO broj	Opis - Izlazni / Ulazni pritisak	OE broj	RAPIDEX broj
1.	475 009 004 0	0,4 - 8 bar	001 429 56 44	KOCN1738
2.	475 009 005 0	0,3 - 8 bar	81.52101.9120	KOCN1739
3.	475 010 015 0	7,3 - 10 bar	0467 6011	KOCN1120
4.	475 010 026 0	1,8 - 8 bar	02.431.09.60.0	KOCN1740
5.	475 010 300 0	8,5 - 10 bar	1506191R	KOCN0865
6.	475 010 301 0	10 - 12,5 bar	81.52101.6270	KOCN0724
7.	475 010 311 0	3,5 - 8,5 bar	81.52101.6084	KOCN1741
8.	475 010 314 0	7 - 10 bar	005 429 04 44	KOCN0750
9.	475 010 318 0	8 - 12 bar	81.52101.6282	KOCN1742
10.	475 015 001 0	7,4 - 16 bar	81.52101.6161	KOCN1743
11.	475 015 004 0	3,5 - 8 bar	0445 7300	KOCN1744
12.	475 015 005 0	8 - 12 bar	002 431 24 06	KOCN1745
13.	475 015 015 0	4 - 10 bar	81.52101.6009	KOCN1211
14.	475 015 018 0	8 - 10 bar	5100020	KOCN0924
15.	475 015 031 0	7,5 - 11 bar	0478 0200	KOCN1747
16.	475 015 032 0	11 - 12,5 bar	9841 3953	KOCN1746

VENTILI OGRANIČENJA PRITISKA

Poz.	WABCO broj	Opis - Izlazni / Ulazni pritisak	OE broj	RAPIDEX broj
17.	475 015 039 0	8,5 - 11 bar	0816 9587	KOCN0762
18.	475 015 046 0	9,5 - 12,5 bar	5010260421	KOCN0742
19.	475 015 063 0	8,5 - 12 bar	20382312	KOCN1748
20.	475 020 006 0	4,1 bar	005 429 39 44	KOCN1175

REPARACIONI SET VENTILA OGRANIČENJA PRITISKA

Poz.	WABCO broj	Primena u aparatu	OE broj	RAPIDEX broj
1.	475 009 000 2	475 009...	000 430 05 68	KOCN1284
2.	475 010 000 2	475 010...	000 420 54 55	KOCN1065
3.	475 010 001 2	475 010...	81.52101.6279	KOCN0552
4.	475 015 001 2	475 015...	81.52161.6269	KOCN1064



VENTILI BRZOG ISPUSTA

Poz.	WABCO broj	Opis	OE broj	RAPIDEX broj
1.	973 500 000 0	M22 x 1,5 mm	UNIVERZALAN	KOCN1273
2.	973 500 028 0	M22 x 1,5 23M16 VOSS	004 429 23 44	KOCN1141
3.	973 500 038 0	M 22 x 1,5 mm / M16	1738495	KOCN0501
4.	973 500 042 0	M 22 x 1,5 mm VOSS	81 52170 6140	KOCN0702
5.	973 500 051 0	INTERGISAN DUPLI	UNIVERZALAN	KOCN0997



DVOSMERNI VENTILI

Poz.	WABCO broj	Tip vozila	OE broj	RAPIDEX broj
1.	434 202 000 0	DAF, MERCEDES, MAN	566360	KOCN1280
2.	434 205 027 0	IVECO, MERCEDES, DAF, MAN	81.52170.6026	KOCN0672
3.	434 205 031 0	VOLVO	1628492	KOCN1669
4.	434 208 000 0	UNIVERZALNI	02.431.00.90.0	KOCN0590
5.	434 208 029 0	UNIVERZALNI	0123 6222	KOCN0888

PRELIVNI VENTILI

Poz.	WABCO broj	Tip vozila	OE broj	RAPIDEX broj
1.	434 100 034 0	MERCEDES, IVECO, MAN	002 429 72 44	KOCN0547
2.	434 100 105 0	UNIVERZALNI	88.52110.6207	KOCN1672
3.	434 100 126 0	UNIVERZALNI	002 429 00 44	KOCN1670

VENTIL RAZVODNIK

Poz.	WABCO broj	Tip vozila	OE broj	RAPIDEX broj
1.	463 036 000 0	UNIVERZALNI	001 997 61 36	KOCN1674
2.	463 036 001 0	UNIVERZALNI	001 997 50 36	KOCN1086



ELEKTROMAGNETNI VENTILI

Poz.	WABCO broj	Tip vozila / Opis	OE broj	RAPIDEX broj
1.	442 040 602 0	MERCEDES, IVECO, SCANIA, DAF	000 543 29 85	KOCN1661
2.	472 070 628 0	MAN	81.52160.6118	KOCN0981
3.	472 070 639 0	MERCEDES ACTROS	005 997 12 36	KOCN0484
4.	472 072 628 0	MAN F2000, TGA	81.52160.6115	KOCN0476
5.	472 072 639 0	MERCEDES ACTROS	005 997 11 36	KOCN0483
6.	472 102 040 0	DAF	1506136R	KOCN1665
7.	472 132 198 0	MAN, RAZVODNIK	81.52160.6087	KOCN1179
8.	472 133 158 0	UNIVERZALNI	1506134	KOCN0701
9.	472 170 600 0	UNIVERZALNI, RAZVODNIK	004 997 90 36	KOCN0993
10.	472 170 604 0	NEOPLAN, MAN, MERCEDES, RAZVODNIK	11017381	KOCN1139
11.	472 170 606 0	DAF, IVECO, SCANIA, RAZVODNIK	5010347977	KOCN0708
12.	472 171 428 0	MAN, RAZVODNIK	81.52160.6114	KOCN1007
13.	472 171 700 0	MERCEDES, MAN, RAZVODNIK	004 997 89 36	KOCN0253
14.	472 172 604 0	MAN, RAZVODNIK	81 52160 6092	KOCN0992



VENTILI PEDALE KOČNICE				
Poz.	WABCO broj	Tip vozila	OE broj	RAPIDEX broj
1.	461 315 008 0	MERCEDES	004 429 62 05	KOCN1270
2.	461 315 019 0	DAF	385759	KOCN1749
3.	461 315 088 0	MAN F90	81.52320.6132	KOCN1750
4.	461 315 150 0	DAF, RENAULT	1505300R	KOCN1751
5.	461 315 180 0	SCANIA, DAF	571190	KOCN1323
6.	461 315 263 0	MERCEDES ATEGO	004 431 41 05	KOCN0718
7.	461 315 264 0	MERCEDES ATEGO	004 431 59 05	KOCN0050
8.	461 316 002 0	MAN	81.52130.9128	KOCN0983
9.	461 317 000 0	DAF, MAN	1506089	KOCN1752
10.	461 318 003 0	MAN, MERCEDES, NEOPLAN	81.52130.6095	KOCN1124
11.	461 318 604 0	DAF, VOLVO, BUS	1524016	KOCN0948
12.	461 319 008 0	FAP, MERCEDES	002 431 10 05	KOCN1753

VENTILI PEDALE KOČNICE				
Poz.	WABCO broj	Tip vozila	OE broj	RAPIDEX broj
13.	461 319 088 0	MAN F90	81.52320.6136	KOCN0982
14.	461 319 260 0	MERCEDES LK	002 431 88 05	KOCN1263
15.	461 319 270 0	MERCEDES	002 431 82 05	KOCN0933
16.	461 319 273 0	MERCEDES ATEGO	004 431 44 05	KOCN0239
17.	461 319 274 0	MERCEDES ATEGO	004 429 62 05	KOCN0240
18.	461 494 110 0	RENAULT	5010097390	KOCN0207



NAGAZNI VENTILI MOTORNE KOČNICE				
Poz.	WABCO broj	Tip vozila	OE broj	RAPIDEX broj
1.	463 013 112 0	MERCEDES, IVECO	000 434 10 01	KOCN1660
2.	463 013 116 0	MERCEDES	000 434 08 01	KOCN1355
3.	463 013 122 0	MAN, SCANIA	81.51610.6007	KOCN0344
4.	463 013 200 0	MERCEDES	000 434 38 01	KOCN1237



VENTILI RUČNE PARKIRNE KOČNICE

Poz.	WABCO broj	Tip vozila / Opis	OE broj	RAPIDEX broj
1.	961 701 100 0	MERCEDES, TAM, MAN	81.52315.9044	KOCN1588
2.	961 702 001 0	MERCEDES, TAM, MAN	0176628R	KOCN1589
3.	961 703 001 0	MERCEDES	000 430 54 81	KOCN1040
4.	961 721 004 0	IVECO	41822694	KOCN0609
5.	961 722 151 0	MERCEDES	001 430 18 81	KOCN1282
6.	961 722 210 0	MERCEDES	000 430 91 81	KOCN0709
7.	961 722 262 0	NEOPLAN, MAN, MERCEDES	81.52315.6086	KOCN1130
8.	961 722 275 0	MERCEDES, SETRA	002 430 24 81	KOCN1344
9.	961 722 314 0	SCANIA	1 518 227	KOCN0609
10.	961 723 001 0	DAF	371274	KOCN0621
11.	961 723 005 0	MERCEDES, DAF	002 430 78 81	KOCN0479
12.	961 723 010 0	MERCEDES ACTROS, DAF	1518231	KOCN1733

VENTILI RUČNE PARKIRNE KOČNICE

Poz.	WABCO broj	Tip vozila / Opis	OE broj	RAPIDEX broj
13.	961 723 028 0	MERCEDES ACTROS, DAF	003 430 79 81	KOCN0653
14.	961 723 104 0	MERCEDES, RVI, DAF	002 430 79 81	KOCN1004
15.	961 723 118 0	MAN F2000	81.52315.6161	KOCN1009
16.	961 723 125 0	MERCEDES ACTROS	003 430 73 81	KOCN1161
17.	961 723 208 0	IVECO, RVI	5010145720	KOCN0359
18.	961 723 212 0	VOLVO FH12	1628144	KOCN0976
19.	961 723 215 0	VOLVO FH12	1078958	KOCN0862
20.	961 723 405 0	MAN F2000, DAF 95	81.52315.6136	KOCN0435
Poz.	KNORR broj	Tip vozila	OE broj	RAPIDEX broj
21.	DPM94AAX	IVECO	98474180	KOCN0495
22.	HB 1143	VOLVO	9515443	KOCN0442
23.	HB1500	MAN	81.52315.6118	KOCN0471

REPARACIONI SET VENTILA RUČNE PARKIRNE KOČNICE

Poz.	WABCO broj	Tip vozila / Opis	OE broj	RAPIDEX broj
1.	961 701 000 2	961 701 ...	695880	KOCN1598
2.	961 701 002 2	961 701 ...	000 430 57 60	KOCN1599
3.	961 702 000 2	961 702 ...	002 586 88 43	KOCN1600
4.	961 702 001 2	961 702 ...	272794	KOCN1315
5.	961 722 002 2	961 722 ...	000 430 57 60	KOCN0910
6.	961 722 003 2	961 722 ...	003 430 32 81	KOCN1294
7.	961 723 000 2	961 723 ...	003 430 52 81	KOCN1596
8.	961 723 001 2	961 723 ...	81.52315.6143	KOCN1597



VENTILI UPRAVLJANJA PRIKOLICE

Poz.	WABCO broj	Tip vozila	OE broj	RAPIDEX broj
1.	973 002 405 0	RENAULT, IVECO, MAN	5000438001	KOCN1680
2.	973 002 521 0	MERCEDES, FAP	001 431 87 05	KOCN1331
3.	973 008 005 0	DAF	92060	KOCN1681
4.	973 009 006 0	MAN F2000	81.52301.6189	KOCN1246
5.	973 009 010 0	VOLVO, DAF, SCANIA	20424432	KOCN1682
6.	973 009 300 0	MAN, DAF	82.52301.6015	KOCN1683



VENTILI PRIKOLIČNI KOČIONI

Poz.	WABCO broj	Tip vozila / Opis	OE broj	RAPIDEX broj
1.	971 002 150 0	PRIKOLIČNI, UNIVERZALNI	79310	KOCN1307
2.	971 002 152 0	PRIKOLIČNI, UNIVERZALNI	76275	KOCN0872
3.	971 002 300 0	PRIKOLIČNI, UNIVERZALNI	02.431.15.10.0	KOCN0986
4.	971 002 301 0	PRIKOLIČNI, UNIVERZALNI	5816897	KOCN0889
5.	971 002 900 0	PRIKOLIČNI, DUPLI, PARKIRNI	971 002 912 0	KOCN0974



OTKOČNI VENTIL I VENTIL RAZVODNIK PRIKOLIČNI

Poz.	KBP	Tip vozila / Opis	OE broj	RAPIDEX broj
1.	963 001 000 0	PRIKOLIČNI	8.283.553.000.0	KOCN1678
2.	963 001 013 0	PRIKOLIČNI	1 738 445	KOCN1169
3.	963 001 016 0	PRIKOLIČNI	1 519 448	KOCN1679
4.	963 001 051 0	PRIKOLIČNI, DUPLI	52190	KOCN0642
5.	963 001 052 0	PRIKOLIČNI, DUPLI	1 506 449	KOCN0343
6.	963 006 001 0	PRIKOLIČNI	6500698	KOCN0511
7.	463 032 022 0	PRIKOLIČNI, UNIVERZALNI	4712512	KOCN1684
8.	463 032 020 0	PRIKOLIČNI, UNIVERZALNI	02.4311.28.00	KOCN1271
9.	SV 3111	PRIKOLIČNI, DUPLI	6773736	KOCN0873



VENTILI RETARDERA

Poz.	WABCO broj	Tip vozila	OE broj	RAPIDEX broj
1.	472 250 000 0	DAF	1505432	MENJ0329
2.	472 260 002 0	MERCEDES ACTROS, DAF		MENJ0331
3.	472 260 005 0	MERCEDES ACTROS, DAF		KOCN0847
4.	472 260 011 0	MERCEDES ACTROS, DAF		MENJ0330



AUTOMATSKI REGULATORI SILE KOČENJA

Poz.	WABCO broj	Tip vozila / Opis	OE broj	RAPIDEX broj
1.	475 701 001 0	DAF, FAP ALB VENTIL	1506205R	KOCN1560
2.	475 702 022 0	PRIKOLIČNI	84492	KOCN1561
3.	475 710 000 0	MERCEDES, RVI, DAF	001 431 32 12	KOCN1562
4.	475 710 003 0	MAN	81.52161.6246	KOCN1563
5.	475 710 006 0	RVI, DAF	5021170215	KOCN1564
6.	475 710 020 0	MERCEDES, FAP	001 431 33 12	KOCN1565
7.	475 710 033 0	DAF, RVI	0371994R	KOCN1566
8.	475 710 036 0	MERCEDES	001 431 83 12	KOCN1567
9.	475 710 136 0	MERCEDES ACTROS	003 431 27 12	KOCN0285
10.	475 711 002 0	MERCEDES	001 431 44 12	KOCN1569
11.	475 711 002 0	MERCEDES	001 431 44 12	KOCN1570
12.	475 711 003 0	MERCEDES, DAF	001 431 48 12	KOCN0075

AUTOMATSKI REGULATORI SILE KOČENJA

Poz.	WABCO broj	Tip vozila / Opis	OE broj	RAPIDEX broj
13.	475 711 013 0	IVECO, RVI	98449593	KOCN1571
14.	475 711 027 0	MERCEDES	001 431 97 12	KOCN1573
15.	475 711 075 0	DAF	1504958R	KOCN0530
16.	475 711 097 0	MAN F2000	81.52161.6354	KOCN1576
17.	475 711 118 0	MERCEDES ACTROS	003 431 22 12	KOCN0550
18.	475 711 126 0	DAF	1302096R	KOCN0867
19.	475 711 155 0	RVI	5010422513	KOCN0233
20.	475 712 000 0	PRIKOLIČNI LSV	1 325 324	KOCN1574
21.	475 713 500 0	DAF, SCANIA, RVI	1 738 427	KOCN1283
22.	475 714 500 0	KÖGEL, RVI	6500671	KOCN1082
23.	475 714 509 0	SCANIA	1 738 428	KOCN1575

REPARACIONI SET AUTOMATSKOG REGULATORA SILE KOČENJA

Poz.	WABCO broj	Primena u aparatu	OE broj	RAPIDEX broj
1.	475 700 003 2	475 700 ...		KOCN1580
2.	475 710 001 2	475 710 ...	000 430 75 60	KOCN1248
3.	475 711 000 2	475 711 ...	000 430 36 60	KOCN1308
4.	475 711 001 2	475 711 ...		KOCN0777
5.	475 712 000 2	475 712 ...	1 518 974	KOCN0270
6.	475 713 000 2	475 713 ...	0812 4818	KOCN0093
7.	475 714 000 2	475 714 ...	93161487	KOCN1228
8.	475 715 000 2	475 715 ...	1 518 977	KOCN0269

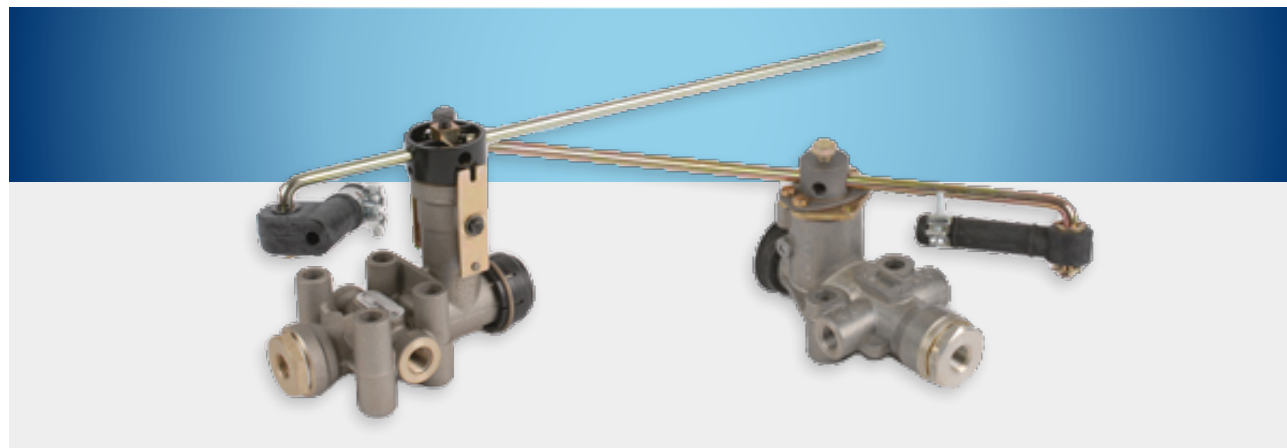

VENTILI NIVELACIJE VAZDUŠNOG OGIBLJENJA

Poz.	WABCO broj	Tip vozila	OE broj	RAPIDEX broj
1.	464 002 330 0	BPW, MERCEDES, VOLVO, MAN	02.431.00.50.0	VESA0778
2.	464 002 440 0	BPW	02.431.07.50.0	KOCN1685
3.	464 002 560 0	IKARBUS		KOCN1686
4.	464 006 000 0	DAF, VOLVO	1506114	VESA0755
5.	464 006 002 0	SCANIA, DAF	579037	VESA0773
6.	464 006 100 0	BPW, MERCEDES, MAN	02.431.13.50.0	VESA0703



VENTILI NIVELACIJE VAZDUŠNOG OGIBLJENJA

Poz.	BOCSH broj	Tip vozila	OE broj	RAPIDEX broj
1.	0 500 004 201	RENAULT	5000791228	VESA1069
2.	0 500 005 001	SCANIA	677279	VESA1070
3.	0 500 005 002	SCANIA	677280	VESA1071

VENTILI NIVELACIJE VAZDUŠNOG OGIBLJENJA

Poz.	BOCSH broj	Tip vozila	OE broj	RAPIDEX broj
4.	0 500 005 006	VOLVO	367838	VESA1072
5.	0 500 005 007	DAF	367839	VESA1073
6.	0 500 005 011	DAF	644521	VESA1074
7.	0 500 005 012	DAF	544520	VESA1075
8.	0 500 005 017	MERCEDES	000 328 43 30	VESA1076
9.	0 500 005 018	MERCEDES	000 328 44 30	VESA1077
Poz.	GRAU broj	Tip vozila	OE broj	RAPIDEX broj
10.	612 032 001	BPW	243113500	VESA1078
Poz.	HALDEX broj	Tip vozila	OE broj	RAPIDEX broj
11.	612 048 111	EVOBUS		VESA1079
12.	612 048 131	EVOBUS, TRAVEGO		VESA1080
13.	612 048 191	EVOBUS	000 327 90 25	VESA1081
Poz.	KNORR broj	Tip vozila	OE broj	RAPIDEX broj
14.	K013741N00	KÄSSBOHRER		VESA1028
15.	SV1200	RENAULT	5000252313	KOCN1034
16.	SV1202	KÄSSBOHRER	8283298000	KOCN1006
17.	SV1260	IVECO	4712511	VESA1083
18.	SV1261	MAN	81.43610.6066	VESA1084
19.	SV1269	MERCEDES	000 328 28 30	VESA1085
20.	SV1280	RENAULT	5000787083	KOCN1110
21.	SV1281	MERCEDES	000 328 33 30	KOCN1048
22.	SV1287	MAN	81.43610.6025	KOCN1129
23.	SV1288	MAN	81.43610.6052	KOCN1001

VENTILI NIVELACIJE VAZDUŠNOG OGIBLJENJA

Poz.	KNORR broj	Tip vozila	OE broj	RAPIDEX broj
24.	SV1290	MAN	81.43610.6057	VESA1086
25.	SV1294	MAN	81.43610.6079	KOCN0956
26.	SV1295	VOLVO	8030222	KOCN0946
27.	SV1296	RENAULT	5000788783	VESA1087
28.	SV1298	RENAULT	5000787249	VESA1088
29.	SV1303	SCANIA	322368	VESA1089
30.	SV1304	MERCEDES	000 328 36 30	VESA1090
31.	SV1307	ERF	412373	VESA1091
32.	SV1310	SETRA	8285011000	VESA1092
33.	SV1318	KÄSSBOHRER	8285086000	KOCN0423
34.	SV1321	ERF	KBSV 1321 ATR	KOCN0422
35.	SV.1323	SCANIA	523852	VESA1093
36.	SV1325	MAN	81.43610.6081	VESA1094
37.	SV1328	SCANIA	523851	VESA1095
38.	SV1329	DAF	287625	VESA1096
39.	SV1330	DAF	287624	VESA1097
40.	SV1343	VOLVO	6780384	VESA1098
41.	SV1345	MAN	81.43610.6090	VESA1099
42.	SV1350	MAN	81.43610.6092	KOCN1318
43.	SV1351	DENIS	651509	VESA1100
44.	SV1361	KÄSSBOHRER	82850008	KOCN0921
45.	SV1369	MAN	81.43610.6101	KOCN0464
46.	SV1370	MAN	81.43610.6100	VESA1101
47.	SV1371	MAN	88.43610.0009	VESA1102
48.	SV1376	RENAULT	5010019987	VESA1103
49.	SV1378	MAN	81.43610.6104	VESA1104

VENTILI NIVELACIJE VAZDUŠNOG OGIBLJENJA

Poz.	KNORR broj	Tip vozila	OE broj	RAPIDEX broj
50.	SV1380	RENAULT	5000787249	VESA1105
51.	SV1381	RENAULT	5000787250	VESA1106
52.	SV1395	MAN	81.43610.6117	VESA1107
53.	SV1399	VOLVO	3036549	KOCN0878
54.	SV1410	FRUEHAUF	CF352131	VESA1108
55.	SV1412	VOLVO	3036548	KOCN0499
56.	SV1418	UNIVERSAL	*	VESA1109
57.	SV1425	IVECO	8189439	VESA1110
58.	SV1426	IVECO	8189440	VESA1111
59.	SV1440	UNIVERSAL	*	VESA1112
60.	SV1441	ERF	413209	KOCN0622
61.	SV1465	UNIVERSAL	*	VESA1113
62.	SV1466	UNIVERSAL	*	VESA0924

VENTILI NIVELEACIJE KABINE

Poz.	WABCO broj	Tip vozila	OE broj	RAPIDEX broj
1.	464 007 001 0	MAN	81.43610.6129	VESA0716
2.	464 007 002 0	DAF, RENAULT, VOLVO	1505082	VESA0049
3.	464 007 003 0	DAF, IVECO, VOLVO	20531967	VESA0047
4.	464 007 010 0	RENAULT, SCANIA	5021170191	VESA0763
5.	464 007 011 0	MERCEDES ACTROS	000 328 45 30	VESA0685

TRISTOP CILINDRI KAMIONSKI

Poz.	WABCO broj	Tip vozila	Opis	OE broj	RAPIDEX broj
1.	925 305 130 0	MERCEDES	12/12	006 420 22 18	KOCN1774
2.	925 325 118 0	MAN	12/12	81 50410 6475	KOCN1191
3.	925 325 206 0	MERCEDES	12/16	012 420 59 18	KOCN1731
4.	925 325 216 0	MERCEDES	12/16	012 420 60 18	KOCN0583
5.	925 326 000 0	MAN	14/12	81.50410.6391	KOCN0492
6.	925 329 000 0	MAN, NEOPLAN	27/30	81 50410 6280	KOCN1525
7.	925 426 200 0	MAN	14/16	81 50410 6579	KOCN0998
8.	925 431 033 0	SCANIA	24/24	5 717 78	KOCN0543
9.	925 460 027 0	DAF, VOLVO	20/24	1522314	KOCN0304
10.	925 460 230 0	MAN TGA	20/24	81 50410 9733	KOCN0861
11.	925 480 004 0	MERCEDES ACTROS	20/24	015 420 47 18	KOCN0498
12.	925 480 005 0	MERCEDES ACTROS	20/24	019 420 64 18	KOCN1732
13.	925 484 021 0	MERCEDES ATEGO	16/24	020 420 59 18	KOCN0968
14.	925 488 000 0	MERCEDES	G-14/24 HFL3	020 420 13 18	KOCN1527
15.	925 488 001 0	-	G-14/24 HFL3	020 420 14 18	KOCN0246
16.	925 490 925 0	UNIVERZALNI	20/24		KOCN0989
17.	925 491 141 0	UNIVERZALNI	24/24	0867215R	KOCN1084
18.	925 492 102 0	UNIVERZALNI	TIP 30"	6500691	KOCN1528
19.	925 494 041 0	MERCEDES, DAF	16/24	1524590R	KOCN0563
20.	925 494 911 0	MERCEDES	16/24	019 420 88 18	KOCN0341

TRISTOP CILINDRI KAMIONSKI

Poz.	WABCO broj	Tip vozila	Opis	OE broj	RAPIDEX broj
21.	925 499 000 0	DAF, VOLVO	27/24	1506761	KOCN0857
22.	925 499 001 0	RVI, DAF	27/30	5021170342	KOCN1526

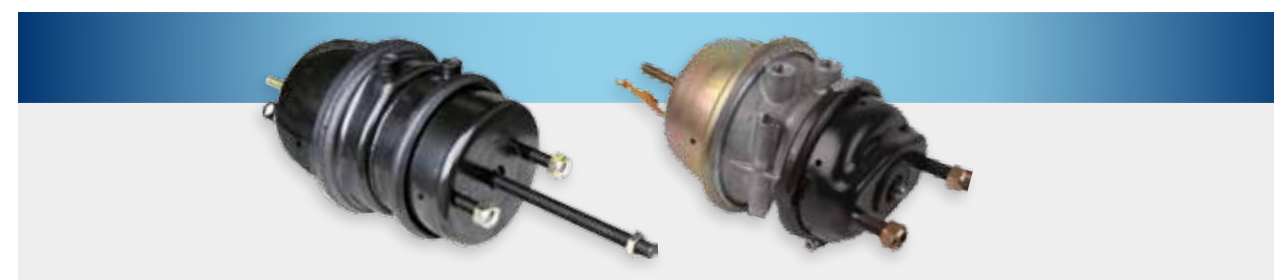
TRISTOP CILINDRI PRIKOLIČNI

Poz.	WABCO broj	Opis			RAPIDEX broj
1.	925 376 100 0	DOBOŠ	24/30	ŠIPKA 186 mm	KOCN0643
2.	925 376 101 0	DOBOŠ	24/30	ŠIPKA 186 mm	KOCN0111
3.	925 376 102 0	DOBOŠ	24/30	ŠIPKA 186 mm	KOCN1529
4.	925 376 106 0	DOBOŠ	24/30	ŠIPKA 208 mm	KOCN1532
5.	925 384 001 0	DISK	16/24		KOCN0074
6.	925 460 100 0	DISK	20/24		KOCN0298

MEMBRANSKI CILINDRI

Poz.	WABCO broj	Opis	RAPIDEX broj
1.	423 103 900 0	DOBOŠ TIP 12	KOCN1520
2.	423 104 298 0	DOBOŠ TIP 16	KOCN1521
3.	423 104 900 0	DOBOŠ TIP 16	KOCN1522

MEMBRANSKI CILINDRI			
Poz.	WABCO broj	Opis	RAPIDEX broj
4.	423 105 111 0	DOBOŠ TIP 20	KOCN1252
5.	423 105 409 0	DOBOŠ TIP 20	KOCN0063
6.	423 105 900 0	DOBOŠ TIP 20	KOCN1288
7.	423 106 106 0	DOBOŠ TIP 24	KOCN0899
8.	423 106 298 0	DOBOŠ TIP 24	KOCN1523
9.	423 106 900 0	DOBOŠ TIP 24	KOCN1268
10.	423 107 900 0	DOBOŠ TIP 30	KOCN1498
11.	423 206 700 0	DOBOŠ TIP 24	KOCN0965
12.	423 505 000 0	DISK TIP 20	KOCN0491
13.	423 506 001 0	DISK TIP 24	KOCN0490

MEMBRANE TRISTOP CILINDRA				
Poz.	WABCO broj	Tip	Prečnik x Visina	RAPIDEX broj
1.	897 120 495 4	TIP 9	Ø128 x 31 mm	KOCN1555
2.	897 120 505 4	TIP 12 P	Ø139 x 31 mm	KOCN1259
3.	897 120 510 4	TIP 16 P	Ø156 x 35 mm	KOCN0445
4.	897 120 515 4	TIP 16 S	Ø158 x 43 mm	KOCN1553
5.	897 120 520 4	TIP 20 P	Ø128 x 31 mm	KOCN0447
6.	897 120 525 4	TIP 20 S	Ø168 x 38 mm	KOCN1225
7.	897 120 530 4	TIP 24 P	Ø179 x 33 mm	KOCN1231
8.	897 120 535 4	TIP 24 S	Ø179 x 40 mm	KOCN1224
9.	897 120 536 4	TIP 24 D	Ø179 x 45 mm	KOCN0717
10.	897 120 540 4	TIP 30 P	Ø199 x 35 mm	KOCN1023
11.	897 120 546 4	TIP 30 D	Ø200 x 44 mm	KOCN1132
12.	897 120 547 4	TIP 27	Ø200 x 36 mm	KOCN1554
13.	897 121 720 4	TIP 14 D	Ø139 x 28 mm	KOCN1551
14.	897 121 923 4	TIP 12 D	Ø162 x 43 mm	KOCN0926



ABS RELEJNI VENTILI				
Poz.	WABCO broj	Tip vozila	OE broj	RAPIDEX broj
1.	472 195 009 0	IVECO, DAF, MAN	0816 7404	KOCN0820
2.	472 195 016 0	MERCEDES ACTROS, DAF	004 429 65 44	KOCN0551
3.	472 195 018 0	DAF, SCANIA, VOLVO	1 079 666	KOCN1164
4.	472 195 031 0	PRIKOLIČNI	50091	KOCN1272
5.	472 195 041 0	PRIKOLIČNI	5815328	KOCN0951

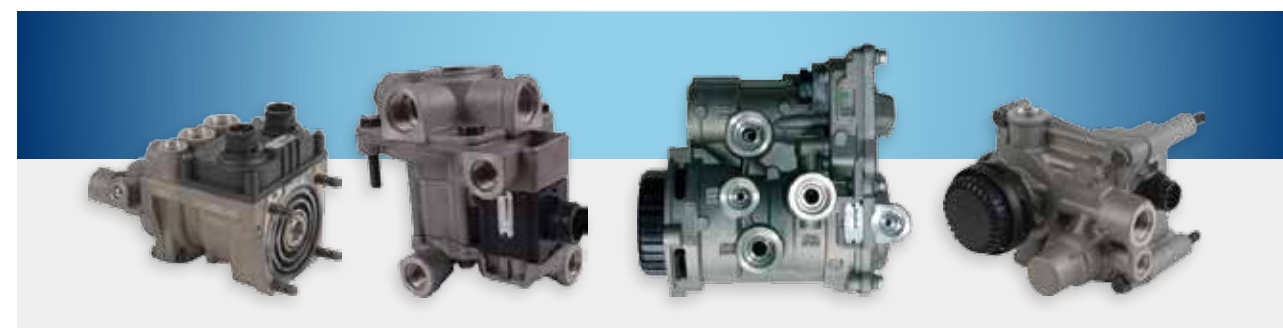

EBS VENTILI - KAMIONSKI				
Poz.	WABCO broj	Tip vozila / Opis	OE broj	RAPIDEX broj
1.	480 001 000 0	MERCEDES ACTROS VOSS 230	004 431 22 05	KOCN1138
2.	480 001 011 0	MERCEDES ACTROS EBS ventil sa prigušivačem	003 431 86 06	KOCN1222
3.	480 001 500 0	DAF XF, CF	1395722	KOCN1632
4.	480 003 000 0	MERCEDES ACTROS MP 2	003 431 95 06	KOCN0598
5.	480 202 004 0	MERCEDES ACTROS, IVECO Proporcionaln EBS rele ventil	005 429 12 44	KOCN1167
6.	480 204 002 0	MERCEDES ACTROS, STRALIS	000 431 94 13	KOCN1500
7.	480 205 001 0	MERCEDES EBS rele ventil	004 429 91 44	KOCN0901
8.	480 205 104 0	MERCEDES ACTROS	005 429 36 44	KOCN0808



EBS VENTIL - KAMIONSKI

Poz.	KBP broj	Tip vozila / Opis	OE broj	RAPIDEX broj
1.	0 486 203 023	MAN	81.52106.6001	KOCN1158
2.	0 486 203 024	VOLVO	20374944	KOCN1734
3.	0 486 203 026	SCANIA	1423910	KOCN1636
4.	0 486 203 030	RENAULT	5010 457 557	KOCN1735
5.	0 486 204 017	MAN	81.52106.6000	KOCN0834
6.	0 486 204 018	VOLVO	20374945	KOCN1736
7.	0 486 204 025	VOLVO FH VERZIJA 2	20374945	KOCN1737



EBS VENTIL - PRIKOLIČNI

Poz.	WABCO broj	Tip vozila / Opis	OE broj	RAPIDEX broj
1.	480 207 001 0	EBS RELE VENTIL	3391030	KOCN0985
2.	971 002 805 0	UNIVERZALNI	5870375	KOCN1046
3.	971 002 921 2	REPARACIONI SET UZ 971 002 805 0	5-9710029212	KOCN1059
4.	971 002 922 2	REPARACIONI SET UZ 971 002 805 0	1664348	KOCN1045



EBS VENTIL - OSOVINSKI MODULATOR - KAMIONSKI

Poz.	WABCO broj	Tip vozila / Opis	OE broj	RAPIDEX broj
1.	480 103 011 0	MERCEDES 4x2	000 429 15 24	KOCN0541
2.	480 103 012 0	MERCEDES 6x2	000 429 22 24	KOCN0971
3.	480 103 015 0	MERCEDES 4x2	000 429 26 24	KOCN0548
4.	480 103 016 0	MERCEDES 6x2	000 429 27 24	KOCN1148
5.	480 103 024 0	IVECO STRALIS	41211004	KOCN0761
6.	480 103 043 0	DAF 4x2	1340390	KOCN0641
7.	480 103 063 0	MERCEDES, MAN	000 429 23 24	KOCN1638

EBS VENTIL - OSOVINSKI MODULATOR - PRIKOLIČNI

Poz.	WABCO broj	Tip vozila / Opis	OE broj	RAPIDEX broj
1.	480 102 014 0	PRIKOLIČNI 4S/3M	56662	KOCN1077
2.	480 102 015 0	PRIKOLIČNI 4S/3M	56632	KOCN1639
3.	480 102 060 0	PREMIUM MAX 4S/3M		KOCN1640



VENTIL UPRAVLJANJA PODIZNE OSOVINE

Poz.	WABCO broj	Tip vozila	OE broj	RAPIDEX broj
1.	463 084 010 0	PRIKOLIČNI	02.431.14.20.0	VESA0516
2.	463 084 030 0	PRIKOLIČNI	2361688	VESA1061



ECAS ELEKTROMAGNETNI VENTIL

Poz.	WABCO broj	Tip vozila	OE broj	RAPIDEX broj
1.	472 900 012 0	DAF, SCANIA	1505292	VESA0514
2.	472 900 032 0	MAN	81.25902.9132	VESA1049
3.	472 900 050 0	MAN AUTOBUS	81.25902.6118	VESA0746
4.	472 900 053 0	DAF, MAN TGA	81.25902.9146	VESA1050
5.	472 900 054 0	MAN F2000, TGA	81.25902.9144	VESA0648
6.	472 900 055 0	DAF, MAN F2000, TGA	81.25902.9145	VESA0426
7.	472 900 057 0	MAN F2000, TGA	81.25902.9158	VESA1051
8.	472 900 060 0	MERCEDES ACTROS	000 327 67 25	VESA0687
9.	472 900 061 0	DAF, SCANIA	1 506 181	VESA1052
10.	472 905 111 0	MAN TGA	81.25902.9147	VESA0612



ECAS RUČNA KOMANDA - TELEKOMADA

Poz.	WABCO broj	Tip vozila	Opis	OE broj	RAPIDEX broj
1.	446 056 113 0	UNIVERZALNI	F/A, R/A, L/AXLE	UNIVERZALNI	VESA0700
2.	446 056 117 0	UNIVERZALNI	F/A, R/A, L/AXLE	UNIVERZALNI	VESA0663
3.	446 056 124 0	RVI	F/A, R/A, L/AXLE	5010249019	VESA1060
4.	446 056 134 0	MERCEDES	F/A, R/AXLE	000 545 87 13	VESA0662
5.	446 056 139 0	MAN	F/A, R/AXLE	81.25505.6601	VESA0661
6.	446 056 146 0	SCANIA	F/A, R/AXLE	1506033	VESA0518



ELEKTRONIKA ABS

Poz.	WABCO broj	Tip vozila / Opis	OE broj	RAPIDEX broj
1.	446 004 314 0	RENAULT	5010143568	KOCN1646
2.	446 004 320 0	IVECO STRALIS	41200566	KOCN1643
3.	446 004 414 0	DAF	1609940	KOCN1645

ELEKTRONIKA EBS

1.	446 130 014 0	MERCEDES, EBS/ECU 4S/4M	000 446 26 36	KOCN1292
2.	446 130 015 0	MERCEDES ACTROS, DAF	000 446 25 36	KOCN0996
3.	446 130 053 0	MERCEDES ACTROS MP2, ECU/EPB	000 446 41 36	KOCN0947

ELEKTRONIKA ECAS - CENTRALA

1.	446 055 046 0	MERCEDES	6 x 2 35 - PINSKI	000 446 08 17	VESA1058
2.	446 055 055 0	BUS	4 x 2 35 - PINSKI	7785008000	VESA0681
3.	446 055 066 0	PRIKOLIČNI	46 - PINSKI	1518019	VESA0654
4.	446 055 301 0		4 x 2 / 6 x 2 25 - PINSKI	81.25935.6713	VESA0411
5.	446 055 302 0		4 x 2 / 6 x 2 25 - PINSKI	81.25935.6712	VESA0519
6.	446 055 409 0		6 x 2 35 - PINSKI	81.25935.6830	VESA1059
7.	446 170 025 0	MERCEDES	4 x 2 18/15 - PINSKI	000 446 31 17	VESA0679
8.	446 170 026 0	MERCEDES	4 x 2 18/15 - PINSKI	000 446 32 17	VESA1057
9.	446 170 053 0	MAN TGA	6 x 2 18/15 - PINSKI	81.25811.7011	VESA0521
10.	446 170 055 0	MERCEDES	6 x 2 18/15 - PINSKI	000 446 33 17	VESA0210
11.	446 170 219 0	DAF XF105	6 x 2		VESA0200



SENZORI ABS

Poz.	WABCO broj	Tip vozila / Opis	RAPIDEX broj
1.	441 032 112 0	MAN TGA, PREDNJI LEVI	KOCN0809
2.	441 032 113 0	MAN TGA, PREDNJI DESNI	KOCN0047
3.	441 032 258 0	2000 mm, LEVI	KOCN0487
4.	441 032 259 0	2000 mm, DESNI	KOCN0950
5.	441 032 265 0	MAN TGA/TGX, ZADNJI	KOCN0347
6.	441 032 266 0	MAN TGA/TGX, ZADNJI	KOCN0348
7.	441 032 283 0	MAN	KOCN1253
8.	441 032 286 0	MAN, 2150 mm	KOCN1654
9.	441 032 288 0	MAN TGM, NEOPLAN, ZADNJI	KOCN0247
10.	441 032 289 0	MAN TGM, NEOPLAN, ZADNJI	KOCN0248
11.	441 032 291 0	MAN, 2150 mm	KOCN1313
12.	441 032 426 0	BUS, 280 mm	KOCN1649
13.	441 032 562 0	MERCEDES SK, 1940 mm	KOCN1650
14.	441 032 623 0	MERCEDES, 2900 mm	KOCN0911
15.	441 032 765 0	MERCEDES, 1440 mm	KOCN0201
16.	441 032 808 0	PRIKOLIČNI 400 mm	KOCN1216
17.	441 032 809 0	PRIKOLIČNI 1000 mm	KOCN0034
18.	441 032 823 0	MERCEDES, 2000 mm	KOCN1651
19.	441 032 905 0	UNIVERZALNI, 350 mm	KOCN1652
20.	441 032 920 0	MERCEDES ACTROS, 2000 mm	KOCN1653
21.	441 032 921 0	MERCEDES ACTROS, 3000 mm	KOCN1262
22.	441 032 921 2	UNIVERZALNI, 400 mm, SET	KOCN1147
23.	441 032 938 2	SCANIA, 2240 mm, SET	KOCN0748

SENZORI ABS			
Poz.	WABCO broj	Tip vozila / Opis	RAPIDEX broj
24.	441 032 963 2	UNIVERZALNI, 350 mm, SET	KOCN0916
25.	441 032 987 0	MAN TGL/M, ZADNJI	KOCN0760
26.	441 032 988 0	MAN TGL/M ZADNJI	KOCN0222



PRODUŽNI KABEL SENZORA

Poz.	WABCO broj	Opis	RAPIDEX broj
1.	449 711 080 0	DUŽINA 8000 mm	KOCN0165
2.	449 711 150 0	DUŽINA 15000 mm	KOCN0166
3.	449 712 008 0	DUŽINA 800 mm	KOCN1655
4.	449 712 018 0	DUŽINA 1800 mm	KOCN0891
5.	449 712 030 0	DUŽINA 3000 mm	KOCN1107
6.	449 712 040 0	DUŽINA 4000 mm	KOCN1656
7.	449 712 051 0	DUŽINA 5100 mm	KOCN0719
8.	449 712 060 0	DUŽINA 6000 mm	KOCN0886
9.	449 712 120 0	DUŽINA 12000 mm	KOCN0973

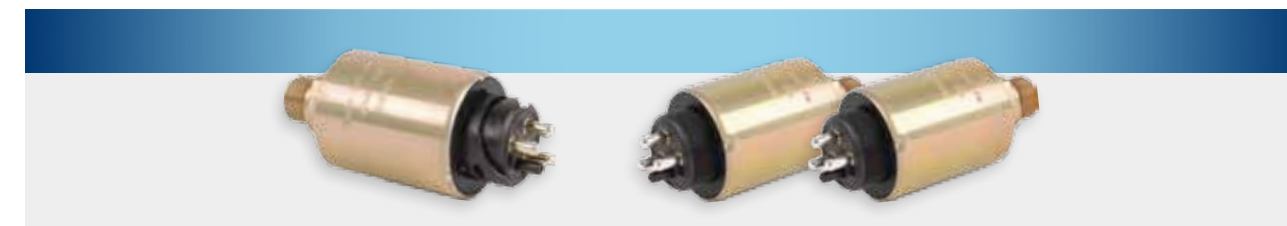

SENZOR PRITISKA

Poz.	WABCO broj	Opis	OE broj	RAPIDEX broj
1.	441 040 013 0	PRIKOLIČNI, 10 bar	53406	KOCN1657
2.	441 040 015 0	PRIKOLIČNI, 10 bar	348313	VESA0427
3.	441 044 102 0	PRIKOLIČNI, 10 bar	504255336	KOCN0582



PREKIDAČI PRITISKA

Poz.	WABCO broj	Opis	OE broj	RAPIDEX broj
1.	441 009 101 0	UNIVERZALNI	002 545 38 24	VESA0642
2.	441 014 006 0	UNIVERZALNI	000 763 09 10	KOCN1658
3.	441 014 010 0	UNIVERZALNI	0249 2526	VESA0488
4.	441 014 017 0	UNIVERZALNI	000 763 21 10	KOCN1659
5.	441 014 025 0	UNIVERZALNI	004 545 90 24	VESA0674



SENZORI ECAS-a

Poz.	WABCO broj	Tip vozila	OE broj	RAPIDEX broj
1.	441 050 006 0	MAN F90, L2000	81.25937.0014	VESA0739
2.	441 050 007 0	RVI	7700816098	VESA0490
3.	441 050 008 0	MERCEDES SK, DAF, SCANIA	010 542 78 17	VESA0777
4.	441 050 010 0	RVI, VOLVO	5010231137	VESA0753
5.	441 050 011 0	MAN F2000	81.25937.0016	VESA0747
6.	441 050 012 0	MERCEDES ACTROS	000 542 40 18	VESA0727
7.	441 050 100 0	DAF CF, LF	1365935	KOCN0843
8.	441 050 120 0	IVECO	41200708	ELEK0244
8.	441 050 121 0	MERCEDES ACTROS MP2	003 542 26 18	VESA0705
10.	441 050 123 0	MAN	81.25937.0040	VESA0745



SERVO CILINDRI KVAČILA

Poz.	WABCO broj	Tip vozila	OE broj	RAPIDEX broj
1.	462 012 101 0	DAF, MAN	81.30725.6005	KVAC0178
2.	470 051 114 0	MAN, IVECO, MERCEDES	81.30725.6034	KOCN0432
3.	970 051 102 0	DAF, NEOPLAN	0658882R	KVAC0179
4.	970 051 107 0	DAF, SCANIA	1505259R	KVAC0129
5.	970 051 111 0	DAF, MAN	1505136R	KVAC0140
6.	970 051 124 0	RVI	5001832980	KOCN0922
7.	970 051 126 0	DAF, MAN, RVI	1505138R	KVAC0139
8.	970 051 127 0	IVECO, DAF, NEOPLAN	4791101	KVAC0180
9.	970 051 129 0	EVOBUS, DAF	8285280000	KVAC0181
10.	970 051 131 0	MERCEDES	001 295 67 07	KVAC0158
11.	970 051 150 0	EVOBUS, DAF	753259	KVAC0182
12.	970 051 151 0	MERCEDES	000 295 08 18	KVAC0183
13.	970 051 157 0	MAN	81.30725.6055	KVAC0138
14.	970 051 158 0	MERCEDES	000 295 15 18	KVAC0101
15.	970 051 159 0	MERCEDES, DAF, RVI	000 295 14 18	KVAC0149
16.	970 051 176 0	DAF, MERCEDES, EVOBUS	1506459	KVAC0137
17.	970 051 217 0	MAN, DAF	81.30725.6060	KVAC0123
18.	970 051 406 0	MAN	81.30725.6069	KVAC0117
19.	970 051 412 0	MAN	81.30725.6084	KVAC0126

SERVO CILINDRI KVAČILA				
Poz.	WABCO broj	Tip vozila	OE broj	RAPIDEX broj
20.	970 051 414 0	MAN F2000, DAF	5021170436	KVAC0133
21.	970 051 423 0	MERCEDES, DAF, RVI	501006570	KVAC0184
22.	970 051 424 0	MERCEDES, DAF, RVI	1506467	KVAC0136
23.	970 051 431 0	MERCEDES ACTROS	000 254 00 47	KVAC0141
24.	970 051 433 0	MERCEDES ACTROS	000 295 37 18	KVAC0030
25.	970 051 435 0	MERCEDES		KVAC0069
26.	970 051 436 0	MERCEDES	000 254 03 47	KVAC0185
27.	970 051 441 0	MAN, MERCEDES	000 254 04 47	KVAC0087
28.	970 051 466 0	MAN F2000		KVAC0036
29.	974 010 001 0	SCANIA	1 412 317	MENJ0229



SERVO CILINDRI KVAČILA				
Poz.	KONGBER broj	Tip vozila	OE broj	RAPIDEX broj
1.	622199AM	SCANIA SERIJA 3	1 331 770	KOCN0466
2.	629276AM	VOLVO	20524584	KVAC0023
3.	629277AM	VOLVO	20524585	KVAC0022
4.	KV 25001A1	VOLVO F, FL	1526523	MENJ0190
5.	KV 25003A1	VOLVO FH	1521371	KVAC0190

REPARACIONI SETOVI SERVO CILINDRA KVAČILA				
Poz.	WABCO broj	Tip vozila	OE broj aparata	RAPIDEX broj
1.	470 051 006 2	IVECO	470 051 114 0	KVAC0005
2.	970 051 903 2	MERCEDES	970 051 131 0	KVAC0154
3.	970 051 905 2	DAF, MAN	970 051 111 0	KVAC0135
4.	970 051 911 2	MAN, DAF	970 051 217 0	KVAC0186
5.	970 051 916 2	MERCEDES	970 051 159 0	KVAC0188
6.	970 051 917 2	MERCEDES	970 051 151 0	KVAC0128
7.	970 051 961 2	MAN	970 051 412 0	KVAC0189
8.	970 051 970 2	MERCEDES	970 051 435 0	KVAC0187
9.	970 051 974 2	MERCEDES ACTROS	970 051 431 0	KVAC0119
10.	970 051 975 2	MERCEDES	970 051 436 0	KVAC0143



PRIMARNI CILINDRI						
Poz.	Tip vozila	KBP	Opis	Odlivak	OE broj	RAPIDEX broj
1.	DAF 65	KG 250005.0.1	Ø25,4 mm	S 5505	1255105	KVAC0191
2.	DAF 75, 85, 95	KG 28010.0.1	Ø28,57 mm	S 5505	894880	KVAC0192
3.	DAF 75	KG 250001.0.2	Ø25,4 mm	S 5171	395161	KVAC0193
4.	DAF 95	KG 22026.01.1	Ø22,2 mm	S 5505	1291190	KVAC0194

PRIMARNI CILINDRI						
Poz.	Tip vozila	KBP	Opis	Odlivak	OE broj	RAPIDEX broj
5.	DAF N 2800,3300	KG 23094.1.12	Ø23,81 mm	S 5138	1291509	KVAC0195
6.	IVECO EUROCARGO	KG 250009.1.1	Ø25,4 mm		4853409	KVAC0196
7.	IVECO EUROCARGO	KG 3106.0.1	Ø31,75 mm		4853408	KVAC0197
8.	IVECO EUROSTAR	KG 3107.1.1	Ø31,75 mm	S 5278	41211006	KVAC0198
9.	MAN M90, F2000	KG 23027.0.1	Ø23,81 mm	S 5500	81.30715.6111	KVAC0236
10.	MAN F90, F2000	KG 2597.1.1	Ø25,4 mm	S 5500	81.30715.6108	KVAC0237
11.	MAN F90, F2000, M2000	KG 23030.0.2	Ø23,81 mm	S 5571	81.30715.6135	KVAC0122
12.	MAN F90, F2000	KG 250007.0.3	Ø25,4 mm	S 5574	81.30715.6136	KVAC0238
13.	MAN F2000	KG 23851.0.1	Ø23,81/31,7 mm	S 5611	81.30715.6146	KVAC0239
14.	MAN M2000 L	KG 22027.0.2	Ø22,2 mm	S 5554	81.30715.6140	KVAC0199
15.	MAN M2000 L	KG 250006.0.2	Ø25,4 mm	S 5554	81.30715.6132	KVAC0200
16.	MAN M2000	KG 22028.0.2	Ø22,2 mm	S 5571	81.30715.6141	KVAC0201
17.	MAN F90	KG 19080.1.3	Ø19,05 mm	S 5310	81.30715.6124	KVAC0071
18.	MAN G90	KG 25794.1.3	Ø25,4 mm	S 5346	81.30715.6116	KVAC0095
19.	MAN TGA	MKG 23852.0.1	Ø23,81/40 mm		81.30715.6154	KVAC0076
20.	MAN SL II BUS	KG 2590.1.1	Ø25,4 mm	S 5126	81.30715.6030	KVAC0202
21.	MERCEDES ACTROS	KG 20001.0.10	Ø20,64 mm	PLASTIKA	001 295 95 06	KVAC0072
22.	MERCEDES ACTROS	KG 20001.0.3	Ø20,64 mm	PLASTIKA	001 295 92 06	KVAC0203
23.	MERCEDES ACTROS	KG 20010.01.1	Ø20,64 mm	PLASTIKA		KVAC0204
24.	MERCEDES ATEGO	KG 23850.1.9	Ø23,81 mm	S 5243	000 295 11 05	KVAC0205
25.	MERCEDES ATEGO	KG 20001.0.8	Ø20,64 mm	PLASTIKA	001 295 91 06	KVAC0118
26.	MERCEDES LK/LN2	KG 19098.1.7	Ø19,05 mm	S 5421	001 295 24 06	KVAC0206
27.	MERCEDES LK/LN2	KG 23021.1.3	Ø23,81 mm	S 5372	680 295 00 06	KVAC0207
28.	MERCEDES LK/LN2	KG 190072.0.1	Ø19,05 mm	S 5421	001 295 96 06	KVAC0208

PRIMARNI CILINDRI						
Poz.	Tip vozila	KBP	Opis	Odlivak	OE broj	RAPIDEX broj
29.	MERCEDES LK/LN2	KG 22019.1.4	Ø22,2 mm	S 5372	673 295 00 06	KVAC0132
30.	MERCEDES MK	KG 190042.0.1	Ø19,05 mm	S 5421	001 295 73 06	KVAC0209
31.	MERCEDES MK	KG 250003.0.1	Ø25,4 mm	S 5477	001 295 65 06	KVAC0210
32.	MERCEDES MK	KG 23031.0.2	Ø23,81 mm	S 5618	001 295 70 06	KVAC0211
33.	MERCEDES SK, NG	KG 2395.1.3	Ø23,81 mm	S 5185	012 956 00 06	KVAC0156
34.	MERCEDES SK, NG	KG 22019.1.1	Ø22,2 mm	S 5372	001 295 74 06	KVAC0132
35.	MERCEDES BUS O301	KG 23021.1.3	Ø23,81 mm	S 5372	012 959 70 06	KVAC0207
36.	MERCEDES BUS TOURISMO, O404	KG 23028.0.1	Ø23,81 mm	S 5185	001 295 78 06	KVAC0212
37.	RENAULT KERAX, MIDLUM	KG 28021.0.1	Ø28 mm		5001834842	KVAC0213
38.	RENAULT MAGNUM AE	KG 28018.1.1	Ø28,57 mm	S 5589	5010452711	KVAC0214
39.	RENAULT MANAGER	KG 2397.1.19	Ø23,81 mm	S 5575	5010056380	KVAC0215
40.	SCANIA 114 G/340	KG 250004.0.2	Ø25,4 mm	S 5524	1 361 136	0216
41.	VOLVO FL6	KG 2397.1.17	Ø23,81 mm	S 5575	3952543	0217
42.	VOLVO FM7	KG 28012.0.1	Ø19,05 mm	S 5547	1628218	0006
43.	VOLVO F10, FL10, 12	KG 28014.1.1	Ø28,57 mm	S 5269	1581209	0125





SEKUNDARNI CILINDRI

Poz.	Tip vozila	KBP	Opis	Odlivak	OE broj	RAPIDEX broj
1.	IVECO EUROCARGO	KN 38014A1	Ø38,1 mm		4854828	KVAC0218
2.	IVECO MK	KN 3809B1	Ø38,1 mm	S 3212	86030915	KVAC0219
3.	IVECO MK	KN 3192B1	Ø31,75 mm	S 6390	42026024	KVAC0220
4.	MAN M90, L2000	KN 31010A1	Ø31,75 mm	S 6607	81.30716.6089	KVAC0221
5.	MAN G90	KN 25031A1	Ø25,4 mm	S 6364	81.30716.6065	KVAC0063
6.	MAN G90	KN 28024C1	Ø28,57 mm	S 6501	81.30716.6078	KVAC0222
7.	MAN M90	KN 31010B1	Ø31,75 mm	S 6648	81.30716.6092	KVAC0223
8.	MAN SL200	KN 3107A1	Ø31,75 mm	S 6207	81.30716.6051	KVAC0224
9.	MERCEDES LK/LN2	KN 28027A1	Ø28,57 mm	S 6469	001 295 40 07	KVAC0225
10.	MERCEDES LK/LN2	KN 3899A1	Ø38,1 mm	S 6529	676 295 00 07	KVAC0226
11.	MERCEDES LK/LN2	KN 25021D1	Ø25,4 mm	S 6167	002 295 17 07	KVAC0227
12.	MERCEDES LP	KN 2895A1	Ø28,57 mm	S 6205	308 295 70 07	KVAC0127
13.	MERCEDES MK	KN 3199A1	Ø31,75 mm	S 6578	002 295 01 07	KVAC0228
14.	MERCEDES NG	KN 28022D1	Ø28,57 mm	S 6486	001 295 96 07	KVAC0229
15.	MERCEDES NG	KN 3805J1	Ø38,1 mm	S 6197	002 295 04 07	KVAC0230
16.	MERCEDES NG	KN 3194C1	Ø31,75 mm	S 6481	001 295 44 07	KVAC0080
17.	MERCEDES NG	KN 3895C1	Ø38,1 mm	S 6405	002 295 10 07	KVAC0231
18.	RENAULT MIDLINER M	KN 38015A1	Ø38,1 mm	S 6687		KVAC0232
19.	SCANIA 93 M, 94 D, 114, 124	KN 38013A1	Ø38,1 mm	S 6676		KVAC0233
20.	VOLVO FL6	KN 3807C1	Ø38,1 mm	S 6218	3127319	KVAC0234
21.	VOLVO F80	KN 3109A1	Ø31,75 mm	S 6157	1502270	KVAC0235



GLAVNI KOČIONI CILINDRI

Poz.	Tip vozila	KBP	Opis	Odlivak	OE broj	RAPIDEX broj
1.	IVECO DAILY	H 25934.0.1	Ø25,4 mm		2991743	KOCN1721
2.	IVECO EUROCARGO	H 3301.0.1	Ø33,34 mm		4817854	KOCN1723
3.	MAN G 10	H 31731.0.0	Ø31,75 mm	S 5329	81.51130.6044	KOCN1722
4.	MERCEDES LP	H 34902.0.1	Ø34,92 mm	S 5296	003 430 94 01	KOCN1724
5.	MERCEDES NG	H 38947.0.2	Ø38,1 mm	S 5154	003 430 74 01	KOCN1725
6.	MERCEDES NG	H 42900.0.1	Ø42,86 mm	S 5179	003 430 32 01	KOCN1726
7.	MERCEDES NG	H 34708.0.1	Ø34,92 mm	S 5249	003 430 55 01	KOCN1727
8.	MERCEDES NG	H 17853.10.1	Ø17,46/20,4 mm	S 5207	000 295 87 06	KOCN1343
9.	MERCEDES VARIO	H 2896.0.2	Ø28,57 mm	S 5448	004 430 72 01	KOCN1728
10.	MERCEDES VARIO	H 2692.0.2	Ø28,57 mm	S 5448	004 430 89 01	KOCN1729
11.	MERCEDES BUS	H 31717.0.0	Ø31,75 mm	S 367	002 430 61 01	KOCN1769
12.	MERCEDES BUS	H 34703.0.0	Ø34,92 mm	S 406	002 430 14 01	KOCN1771
13.	RENAULT MIDLINER S	H 41901.0.7	Ø41,27 mm	S 5154	5000547 036	KOCN1772
14.	RENAULT MIDLINER S	H 41905.0.4	Ø41,27 mm	S 5497	5010037 151	KOCN1773

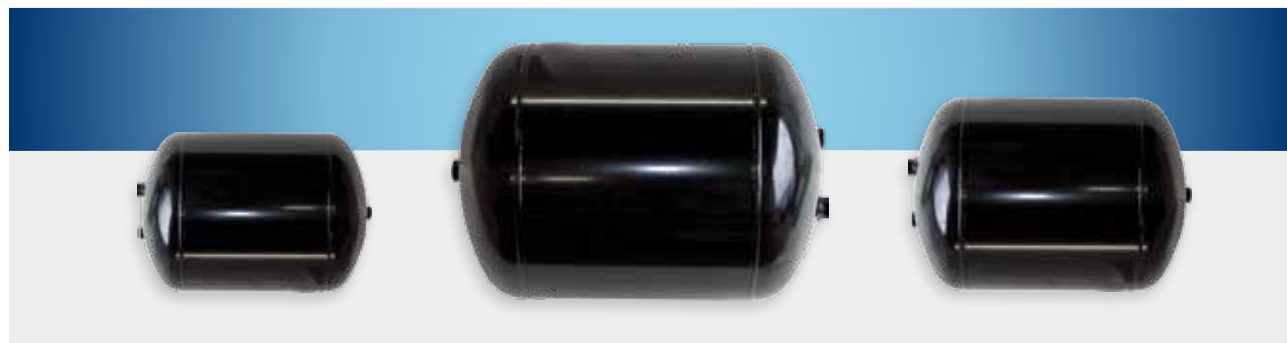

REZERVOARI ZA VAZDUH

Poz.	WABCO broj	Opis	RAPIDEX broj
1.	451 999 246 2	DRZAČ REZERVOARA VAZDUHA Ø246 mm	OPRE0086
2.	451 999 276 2	DRZAČ REZERVOARA VAZDUHA Ø276 mm	KOCN1608
3.	451 999 310 2	DRZAČ REZERVOARA VAZDUHA Ø310 mm	KOCN1607
4.	950 105 001 0	REZERVOAR VAZDUHA 5 litara, Ø152 x 356 mm	KOCN1606
5.	950 410 004 0	REZERVOAR VAZDUHA 10 litara, Ø206 x 335 mm	KOCN1603
6.	950 540 001 0	REZERVOAR VAZDUHA 40 litara, Ø246 x 915 mm	KOCN1605
7.	950 820 001 0	REZERVOAR VAZDUHA 20 litara, Ø300 x 380 mm	KOCN1604



CREVA VAZDUHA

Poz.	WABCO broj	Opis	Dužina	Boja	RAPIDEX broj
1.	452 711 001 0	SPIRALNO M22 x 1,5 mm	4,5 m	crveno	KOCN1556
2.	452 711 002 0	SPIRALNO M22 x 1,5 mm	4,5 m	zuto	KOCN1557
3.	452 711 006 0	SPIRALNO M16 x 1,5 mm	4,5 m	crveno	KOCN1559
4.	452 711 007 0	SPIRALNO M16 x 1,5 mm	4,5 m	zuto	KOCN1558
5.	452 711 011 0	SPIRALNO M16 x 1,5 mm	4,5 m	crveno	KOCN1275
6.	452 711 012 0	SPIRALNO M16 x 1,5 mm	4,5 m	zuto	KOCN1274



SPOJNA GLAVA

Poz.	WABCO broj	Opis	RAPIDEX broj
1.	452 200 011 0	M22 mm, ŽUTA, DUPLI VOD	KOCN1609
2.	452 200 012 0	M22 mm, CRVENA, DUPLI VOD	KOCN1610
3.	452 300 011 0	M22 mm, CRNA, MOTORNO VOZILO, max 8 bar	KOCN0791
4.	452 300 031 0	M22 x 1,5 mm, CRNA, MOTORNO VOZILO, max 8 bar	KOCN0792
5.	452 802 007 0	DUOMATIC - BRZA, M16 x 1,5 mm	KOCN0743
6.	452 802 009 0	DUOMATIC - BRZA sa ABE, M16 x 1,5 mm	KOCN1044
7.	452 803 005 0	DUOMATIC - BRZA, PRIKLJUČAK ABE, M16 x 1,5 mm	KOCN0521
8.	452 804 012 0	DUOMATIC - BRZA, VUČNO VOZILO, M16 x 1,5 mm	KOCN1043
9.	452 805 004 0	DUOMATIC - BRZA, M16 x 1,5 mm	KOCN0520
10.	952 200 021 0	M16 mm, CRVENA, PRIKOLICA	KOCN1345
11.	952 200 022 0	M16 mm, ŽUTA, PRIKOLICA	KOCN1346
12.	952 200 221 0	M16 mm, CRVENA, KAMION	KOCN1347
13.	952 200 222 0	M16 mm, ŽUTA, KAMION	KOCN1357
14.	952 201 001 0	SA FILTEROM, M16 mm, ŽUTA, max 8,5 bar	KOCN0827
15.	952 201 002 0	SA FILTEROM, M16 mm, CRVENA, max 8,5 bar	KOCN0826



CREVA VAZDUŠNE INSTALACIJE

Poz.	Opis	Dužina	KBP	RAPIDEX broj
1.	4 x 1,0 mm	25 m	T 7300.15	KOCN1068
2.	5 x 1,0 mm	25 m	T 7300.27	KOCN0885
3.	6 x 1,0 mm	25 m	T 7300.01	KOCN1073
4.	8 x 1,0 mm	25 m	T 7300.02	KOCN1067
5.	9 x 1,5 mm	25 m	T 7300.14	KOCN0853
6.	10 x 1,0 mm	25 m	T 7300.03	KOCN1072
7.	12 x 1,5 mm	25 m	T 7300.04	KOCN1071
8.	15 x 1,5 mm	25 m	T 7300.05	KOCN1070
9.	18 x 2,0 mm	25 m	T 7300.20	KOCN1069
10.	NW 11 x 3,5 mm	40 m	T 7299.97	KOCN0904
11.	NW 13 x 6,0 mm	40 m	T 7299.98	KOCN0903
12.	NW 15 x 5,0 mm	40 m	T 7299.96	KOCN0902



SPOJNICE CREVA

Poz.	WABCO broj	Opis	RAPIDEX broj
1.	893 129 401 2	CREVO 11 x 3,5 mm, M16 x 1,5 mm	OSTA0257
2.	893 129 402 2	CREVO 11 x 3,5 mm, M22x1,5 mm	OSTA0256
3.	893 129 403 2	CREVO 13 x 6 mm, M16x1,5 mm	OSTA0255
4.	893 129 404 2	CREVO 13 x 6 mm, M22x1,5 mm	OSTA0254
5.	893 226 682 2	UTIČNICA VOSS NG8 WABCO	OPRE0209
6.	893 226 689 2	ADAPTER M16 VOSS SA 232 NA 230	OPRE0021
7.	893 226 690 2	ADAPTER M22 VOSS SA 232 NA 230	OPRE0022
8.	893 800 005 2	CREVO 8 x 1 mm, M22 x 1,5 R mm	OSTA0176
9.	893 803 400 0	CREVO 8 x 1 mm, M22 x 1,5 mm	OSTA0268
10.	893 803 410 0	CREVO 10 x 1 mm, M16 x 1,5 mm	OSTA0267
11.	893 803 420 0	CREVO 10 x 1 mm, M22 x 1,5 mm	OSTA0266
12.	893 803 430 0	CREVO 12 x 1,5 mm, M16 x 1,5 mm	OSTA0265
13.	893 803 440 0	CREVO 12 x 1,5 mm, M22 x 1,5 mm	OSTA0264
14.	893 803 460 0	CREVO 15 x 1,5 mm, M22 x 1,5 mm	OSTA0263
15.	893 803 490 0	CREVO 8 x 1 mm, M12 x 1,5 mm	OSTA0270
16.	893 803 540 0	CREVO 8 x 1 mm, M16 x 1,5 mm	OSTA0269
17.	893 803 580 0	CREVO 6 x 1 mm, M12 x 1,5 mm	OSTA0271
18.	893 803 690 0	CREVO 16 x 2 mm, M22 x 1,5 mm	OSTA0261
19.	893 803 700 0	CREVO 6 x 2 mm, M10 x 1,5 mm	OSTA0258
20.	893 803 780 0	CREVO 15 x 2 mm, M22 x 1,5 mm	OSTA0262

SPOJNICE CREVA				
Slika	Poz.	Opis	KBP	RAPIDEX broj
	1.	6 x 1,0 mm	T 7700.01	KOCN1694
	2.	8 x 1,0 mm	T 7700.02	KOCN1695
	3.	9 x 1,0 mm	T 7700.08	KOCN1087
	4.	10 x 1,0 mm	T 7700.03	KOCN1696
	5.	11 x 1,5 mm	T 7700.04	KOCN1697
	6.	12 x 1,5 mm	T 7770 .05	KOCN1698
	7.	15 x 1,5 mm	T 7700.06	KOCN1103
	8.	6 x 1,0 mm	T 7710.01	KOCN1699
	9.	8 x 1,0 mm	T 7710.02	KOCN1700
	10.	10 x 1,0 mm	T 7710.03	KOCN1701
	11.	12 x 1,5 mm	T 7710.04	KOCN1702
	12.	15 x 1,5 mm	T 7710.05	KOCN1703
	13.	6 x 1,0 mm	T 7720.01	KOCN1704
	14.	8 x 1,0 mm	T 7720.02	KOCN1705
	15.	10 x 1,0 mm	T 7720.03	KOCN1706
	16.	12 x 1,5 mm	T 7720,04	KOCN1707
	17.	15 x 1,5 mm	T 7720.05	KOCN1708
	18.	4 mm	T 7820.00	KOCN1102
	19.	5 mm	T 7820.01	KOCN1101
	20.	6 mm	T 7820.02	KOCN1100
	21.	8 mm	T 7820.03	KOCN1099
	22.	10 mm	T 7820.04	KOCN1098
	23.	12 mm	T 7820.05	KOCN1097
	24.	15 mm	T 7820.06	KOCN1096
	25.	22 mm	T 7820.08	KOCN1095
		26.	4 mm	T 7830.00
27.		5 mm	T 7830.01	KOCN1710
28.		6 mm	T 7830.02	KOCN1028
29.		8 mm	T 7830.03	KOCN1027
30.		10 mm	T 7830.04	KOCN1026
31.		12 mm	T 7830.05	KOCN1025
32.		15 mm	T 7830.06	KOCN1709

SPOJNICE CREVA					
Slika	Poz.	Opis	KBP	RAPIDEX broj	
	33.	4 mm	T 7840.00	KOCN1022	
	34.	5 mm	T 7840.01	KOCN1713	
	35.	6 mm	T 7840.02	KOCN1021	
	36.	8 mm	T 7840.03	KOCN1020	
	37.	10 mm	T 7840.04	KOCN1019	
	38.	12 mm	T 7840.05	KOCN1018	
	39.	15 mm	T 7840.06	KOCN1714	
		40.	9 - 9 x 1,5 mm	T 0914.07	OPRE0002
		41.	9 - 11 x 1,5 mm	T 0914.08	OPRE0003
42.		9 - 12 x 1,5 mm	T 0914.09	OPRE0012	
43.		13 - 9 x 1,5 mm	T 0914.10	OPRE0004	
44.		13 - 11 x 1,5 mm	T 0914.11	OPRE0005	
45.		13 - 12 x 1,5 mm	T 0914.12	OPRE0006	
46.		13 - 14 x 2,0 mm	T 0914.13	OPRE0007	
47.		13 - 16 x 2,0 mm	T 0914.14	OPRE0028	
		48.	NG 8/6 x 1 mm	T 1983.01	KOCN1715
	49.	NG 8/8 x 1 mm	T 1983.02	KOCN0995	
	50.	NG 12/6 x 1 mm	T 1983.03	KOCN1716	
	51.	NG 12/8 x 1 mm	T 1983.04	KOCN1017	
	52.	NG 12/12 x 1,5 mm	T 1983.05	KOCN1016	
	53.	NG 12/16 x 2 mm	T 1983.06	KOCN1717	
	54.	NG 8 mm	T 1983.07	KOCN1015	
	55.	NG 12 mm	T 1983.08	KOCN1014	
	56.	M 16 x 1,5 SW22	T 7150.08	KOCN0816	
	57.	M 22 x 1,5 SW27	T 7150.09	KOCN0815	



PRIGUŠIVAČI ZVUKA

Poz.	WABCO broj	Opis	OE broj	RAPIDEX broj
1.	432 407 012 0	Ø87 x 62 mm	000 430 20 70	KOCN0746
2.	432 407 060 0	Ø69 x 56,5 mm	000 430 03 70	KOCN0858
3.	432 407 070 0	Ø 69 x 53 mm	000 430 09 70	KOCN0859



TEČNOST PROTIV SMRZAVANJA INSTALACIJA

Poz.	WABCO broj	Opis	RAPIDEX broj
1.	830 702 087 4	WABCOTIL 1/1	ULJA0042
2.	830 702 090 4	WABCOTIL 200/1	ULJA0043



STANDARDNI SET WABCO ABS-a VCS II GENERACIJE ZA POLUPRIKOLICE TIP 2S/2M

Elementi seta	Komada
MODULATOR VCS II TIP 2S/2M	1
NAPOJNI KABEL VCS II	1
PRODUŽNI KABEL SENZORA ABS-a	2
DIJAGNOSTIČKI KABEL VCS II	1
RAPIDEX broj: KOCN1109	



STANDARDNI SET WABCO ABS-a VCS II GENERACIJE ZA POLUPRIKOLICE TIP 4S/2M

Elementi seta	Komada
MODULATOR VCS II TIP 4S/2M	1
NAPOJNI KABEL VCS II	1
PRODUŽNI KABEL SENZORA ABS-a	4
DIJAGNOSTIČKI KABEL VCS II	1
RAPIDEX broj: KOCN0720	



**STANDARDNI SET WABCO EBS-a
"D" GENERACIJE ZA PRIKOLICE SA RUDOM TIP 4S/3M**

Elementi seta	Komada
MODULATOR EBS-a "D" GENERACIJE 4S/3M	1
RELE VENTIL EBS-a ZA PRIKOLICE SA RUDOM	1
NAPOJNI KABEL EBS	1
PRODUŽNI KABEL SENZORA ABS-a	4
DIJAGNOSTIČKI KABEL EBS	1
OTKOČNI VENTIL PRIKOLICE	1
VENTIL PODIZNE OSOVINE	1
EKSTERNI SENZOR PRITISKA	1
BRZOISPUSNI VENTIL	1

RAPIDEX broj: KOCN1756



**STANDARDNI SET WABCO EBS-a
"D" GENERACIJE ZA POLUPRIKOLICE TIP 4S/3M**

Elementi seta	Komada
MODULATOR EBS-a "D" GENERACIJE 4S/3M	1
NAPOJNI KABEL EBS	1
PRODUŽNI KABEL SENZORA ABS-a	4
DIJAGNOSTIČKI KABEL EBS	1
OTKOČNI VENTIL PRIKOLICE	1
VENTIL PODIZNE OSOVINE	1
BRZOISPUSNI VENTIL	1

RAPIDEX broj: KOCN1757



STANDARDNI SET WABCO EBS-a "E" GENERACIJE ZA POLUPRIKOLICE TIP 2S/2M	
Elementi seta	Komada
MODULATOR EBS-a "E" STANDARD	1
NAPOJNI KABEL EBS "E"	1
PRODUŽNI KABEL SENZORA ABS-a	2
DIJAGNOSTIČKI KABEL EBS "E"	1
OTKOČNI VENTIL PRIKOLICE	1
WABCO SMART BOARD	1
RAPIDEX broj: KOCN1758	



DIJAGNOSTIKA
Hardver & Softver
WABCO

Dok je ranijih godina za dijagnostiku svakog sistema na komercijalnim vozilima bio potreban poseban dijagnostički uređaj, danas je dovoljno posedovati Laptop ili desktop računar sa potrebnim programom - softverom.

WABCO raspolaže sa dva dijagnostička sistema:

- XD - WABCO Expert dijagnostika
- SD - WABCO Sistemska dijagnostika.

Za svaku od ovih dijagnostika nudimo neophodnu opremu i programe.

WABCO **XD - EXPERT DIJAGNOSTIKA**

XD je skraćenica za EXPERT dijagnostiku i predstavlja WABCO dijagnostiku za WABCO sisteme i sisteme razvijene i proizvedene od drugih proizvođača.

XD je jedan univerzalan »alat« sa mnogobrojnim funkcijama.

XD postoji u četiri osnovna paketa, napravljena da zadovolje različite potrebe korisnika.

Osnovne mogućnosti kojima raspolaže XD-dijagnostika su:

- MOGUĆNOST DIJAGNOSTIKE MOTORA I KOMPONENTI
- MOGUĆNOST DIJAGNOSTIKE KOČIONOG SISTEMA
- MOGUĆNOST DIJAGNOSTIKE VAZDUŠNOG OGIBLJENJA
- MOGUĆNOST DIJAGNOSTIKE MENJAČA I KOMPONENTI

WABCO XD - PAKETI

- **Compact Paket 446 302 001 0 / RAPIDEX broj: KOCN1759**



- **Advanced Paket 446 302 102 0 / RAPIDEX broj: KOCN1760**
(paket XD + WABCO SD dijagnostika)



- **Advanced Paket 446 302 104 0 / RAPIDEX broj: KOCN1761**



- **Premium Paket 446 302 103 0** ▶
RAPIDEX broj: KOCN1762

WABCO

SD - SISTEMSKA DIJAGNOSTIKA

Za SD dijagnostiku WABCO sistema koristi se sledeća oprema:

- KOFER ZA PROVERU PNEUMATSKE KOČIONE INSTALACIJE
- KOFERI SA DIJAGNOSTIČKOM OPREMOM
- PAKETI DIJAGNOSTIČKIH PROGRAMA

WABCO SD - OPREMA

• Kofer za dijagnostiku pneumatske kočione instalacije



W: 435 002 007 0
R: KOCN1763

• Kofer za dijagnostiku prikoličnih sistema **W: 446 301 023 0** **R: KOCN0837**

Sadržaj kofera za dijagnostiku sistema na prikolicama i poluprikolicama:

- Diagnostic Interface
- Trailer Standardkabel
- CAN Adapter
- CAN Adapterkabel
- VCS I
- VCS II
- TEBS C / D



• Kofer za dijagnostiku sistema na kamionima **W: 446 301 025 0** **R: KOCN1764**

Sadržaj kofera za dijagnostiku sistema na kamionima:

- Adapter 35-pol EPS
- Kabel MB Actros/Citaro
- Kabel EBS Euro Neoplan
- Kabel MAN-TGA
- Kabel EBS IVECO Stralis
- Kabel ABS-D
- Kabel EBS DAF
- Kabel Actros MPII (OBD II)
- Kabel ECAS
- Kabel 15-pol. DAF, Scania, MAN (OBD II)
- Kabel ABS D/E ISO 9141



• Kofer za dijagnostiku sistema na autobusima **W: 446 301 026 0** **R: KOCN1765**

Sadržaj kofera za dijagnostiku sistema na autobusima:

- Diagnostic Interface
- Kabel MB Actros/Citaro
- Kabel EBS Euro Neoplan
- Kabel MAN-TGA
- Kabel Setra NF 315 MTS
- Kabel Actros MPII (OBD II)
- Kabel 15-pol. DAF, Scania, MAN (OBD II)



• Paketi dijagnostičkih programa:

- PAKET FULL (KAMIONI, AUTOBUSI, PRIKOLICE) **W: 246 301 900 0**
R: OPRE0098
- PAKET PRIKOLICA - POLUPRIKOLICA **W: 246 301 901 0**
R: OPRE0524
- PAKET AUTOBUSI **W: 246 301 902 0**
R: OPRE0525
- PAKET KAMIONI **W: 246 301 904 0**
R: OPRE0526



RAPIDEX TRADE svake godine u saradnji sa WABCO-m organizuje **OBUKU - TRENING** za servisere WABCO sistema.

Obuka se odvija u **EDUKATIVNOM CENTRU** u Novom Sadu, Novosadski put 160.

Do sada je obuku uspešno završilo nekoliko generacija polaznika, koje se uspešno nose sa svakodnevnim problemima kvarova na vozilima širom Srbije i zemalja u okruženju.

Predavač WABCO TRENER gospodin Berislav Babić



Detalji sa obuke u edukativnom centru



- **PROIZVODI i REŠENJA** za komercijalna vozila
- **PRIMENA** za proizvodnju vozila
- **ORIGINALNI KVALITET** za Popravku

4.0 KOMPONENTE KOČIONOG SISTEMA

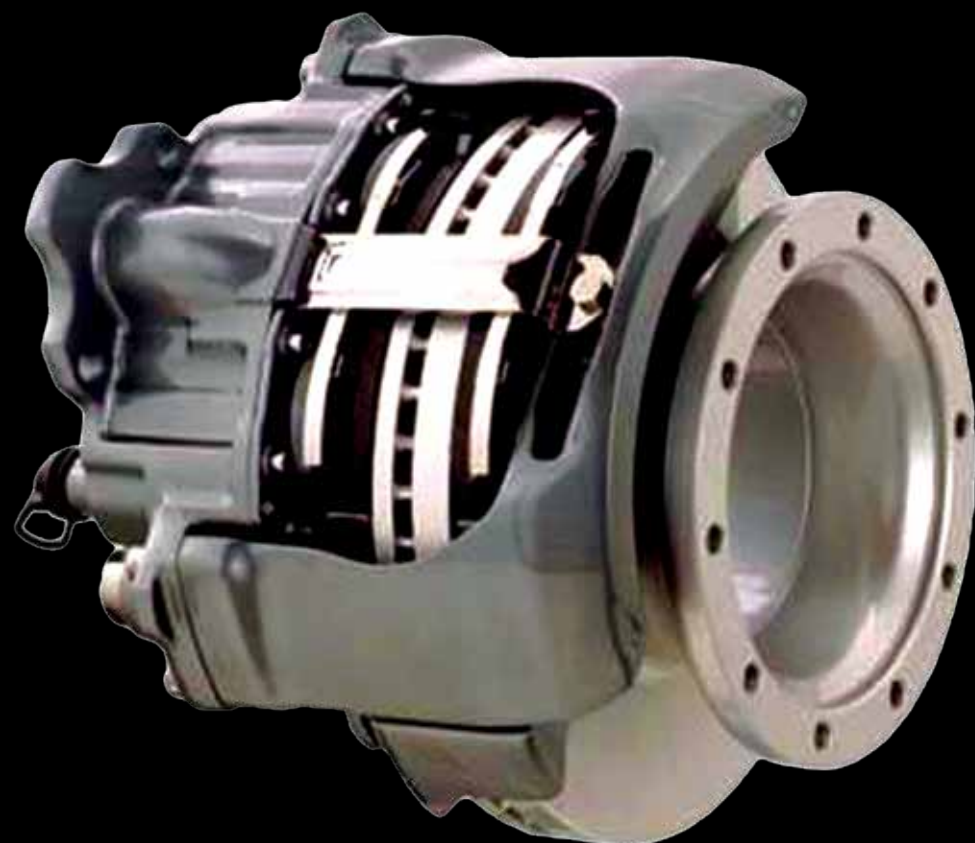
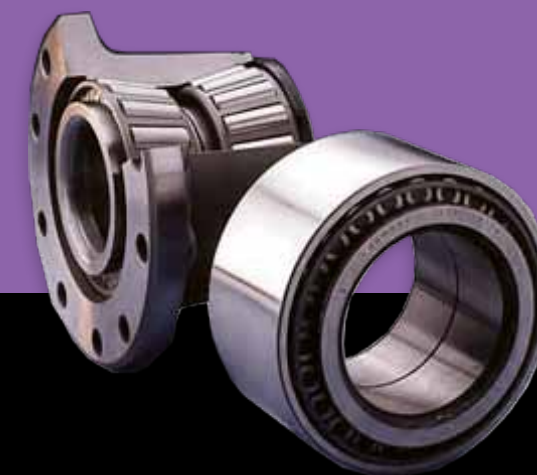



4.0 KOMPONENTE KOČIONOG SISTEMA



4.1	Disk kočnica	192
4.2	Kočione pločice	205
4.3	Čeljusti kočnica	214
4.4	Doboši kočnica	219
4.5	Nosači kočionih obloga	228
4.6	Kočione obloge	230
4.7	Anker ploče	243
4.8	Šteleri kočnica	248
4.9	Kočione osovine (S ključevi)	260
4.10	Glavčine točka, ležajevi i semerinzi	266
4.11	Vijci i navrtke	275

[NAZAD NA GLAVNI SADRŽAJ](#)

DAF							
Slika	Poz.	Tip vozila	A (mm)	B (mm)	C (mm)	OE broj	RAPIDEX broj
	1.	CF65, CF85, XF95, XF105	432	258	45	Z0009911	KOCN0121
	2.	BOVA/OD95/ DAF BUS	430	45	203	B221412	KOCN1435
	3.	LF 55	375	99	10 x Ø16	1400069	KOCN1436
	4.	LF	460	119	10 x Ø16	1238372	KOCN1437

IVECO							
Slika	Poz	Tip vozila	A (mm)	B (mm)	C (mm)	OE broj	RAPIDEX broj
	1.	STRALIS	436	138,5	12 x Ø16	2992477	KOCN0325
	2.	EURO STAR	430	101	12 x Ø16	01907631	KOCN0763

IVECO							
Slika	Poz.	Tip vozila	A (mm)	B (mm)	C (mm)	OE broj	RAPIDEX broj
	3.	DAILY	289	84,5	8 x Ø10,5	1908773	KOCN0850
	4.	DAILY	290	111	6 x Ø18	1908772	KOCN0851
	5.	EUROCARGO	304	128,5	6 x Ø18,5	1907725	KOCN1438
	6.	STRALIS	436	138,5	12 x Ø16	07179778	KOCN0794

MAN							
Slika	Poz	Tip vozila	A (mm)	B (mm)	C (mm)	OE broj	RAPIDEX broj
	1.	L 2000	324	102	10 x Ø14	81.50803.0010	KOCN0937
	2.	L 2000	330	104	10 x Ø14	81.50803.0026	KOCN0943

MAN							
Slika	Poz.	Tip vozila	A (mm)	B (mm)	C (mm)	OE broj	RAPIDEX broj
	3.	F 2000	438	135	10 x Ø16	81.50803.0009	KOCN0963
	4.	F 2000	438	135	10 x Ø16	81.50803.0015	KOCN0232
	5.	L 2000 N.T.	330	135	10 x Ø12	81.50803.0061	KOCN0129
	6.	TGA	432	130	10 x Ø19	81.50803.0023	KOCN0130
	7.	TGA	432	135	10 x Ø16	81.50803.0041	KOCN0892
	8.	TGA	432	135	10 x Ø16	81.50803.0021	KOCN0131



MAN							
Slika	Poz.	Tip vozila	A (mm)	B (mm)	C (mm)	OE broj	RAPIDEX broj
	9.	TGA, TGL	335	176	10 x Ø14	81.50803.0054	KOCN1439
	10.	TGL	335	176	10 x Ø12	81.50803.0063	KOCN1440
	11.	TGL	335	93	10 x Ø14	81.50803.0042	KOCN1441
	12.	L 2000	330	129,5	8 x Ø12	81.50803.0039	KOCN0448
	13.	F90	432	135	10 x Ø16	81.50803.0048	KOCN0021
	14.	F2000, LION'S, M2000, TGA,	432	130	12 x Ø19	81.50803.0040	KOCN0967

MERCEDES							
Slika	Poz.	Tip vozila	A (mm)	B (mm)	C (mm)	OE broj	RAPIDEX broj
	1.	ACTROS	430	132,5	10 x Ø14	942 421 09 12	KOCN0940
	2.	ACTROS	430	132,5	10 x Ø14	942 421 21 12	KOCN0138
	3.	609 711	304	91	6 x Ø12	669 421 06 12	KOCN0852
	4.	ATEGO	324	91	6 x Ø12	970 421 06 12	KOCN0529
	5.	VARIO	304	91	6 x Ø12	668 421 01 12	KOCN1442
	6.	TOURISMO	438	135	10 x Ø14	356 421 12 12	KOCN0906

MERCEDES							
Slika	Poz.	Tip vozila	A (mm)	B (mm)	C (mm)	OE broj	RAPIDEX broj
	7.	714 VARIO	324	91	6 x Ø12	670 421 03 12	KOCN1443
	8.	SPRINTER	276	77	5 x Ø15	902 421 03 12	KOCN1089
	9.	ATEGO	377	138,5	8 x Ø14	975 423 03 12	KOCN0134
	10.	ATEGO	335	111	8 x Ø12	970 423 12 12	KOCN0132
	11.	MK SK	410	175	8 x Ø12	301 423 01 01	KOCN0137
	12.	VITO	272	96	5 x Ø15	638 423 01 12	KOCN0755

MERCEDES							
Slika	Poz.	Tip vozila	A (mm)	B (mm)	C (mm)	OE broj	RAPIDEX broj
	13.	VITO	304	91	6 x Ø12	638 421 01 12	KOCN0732
	14.	SPRINTER	335	111	8 x Ø12	901 423 06 12	KOCN0876
	15.	609 714	304	91	6 x Ø12	669 421 01 12	KOCN0136
	16.	SPRINTER	285	93	6 x Ø15	904 423 03 12	KOCN0905
	17.	SPRINTER	276	77	5 x Ø15	902 421 06 12	KOCN0137
	18.	ATEGO	330	129,5	8 x Ø12	970 423 02 12	KOCN1378

MERCEDES							
Slika	Poz.	Tip vozila	A (mm)	B (mm)	C (mm)	OE broj	RAPIDEX broj
	19.	ATEGO N.T.	377	134	14 x Ø14,5	975 421 02 12	KOCN0810
	20.	VARIO	304	91	30	669 421 06 12	KOCN1094
	21.	ATEGO N.T.	377	138,5	8 x Ø14	975 423 06 12	KOCN0836
	22.	ATEGO	300	85	6 x Ø15	906 421 00 12	KOCN1444
	23.	Prikolica MERCEDES osovina	377	132	10 x Ø10	675 421 00 12	KOCN0075

RENAULT							
Slika	Poz.	Tip vozila	A (mm)	B (mm)	C (mm)	OE broj	RAPIDEX broj
	1.	MAJOR MANAGER	440	97	10 x Ø17	5010216548	KOCN0303
	2.	MAGNUM AE PREMIUM	438	97	10 x Ø17	5010216437	KOCN0712

SCANIA							
Slika	Poz.	Tip vozila	A (mm)	B (mm)	C (mm)	OE broj	RAPIDEX broj
	1.	SERIJA 4 124, 144	430	131	10 x Ø16	1 402 272 1 386 686	KOCN0513



VOLVO							
Slika	Poz.	Tip vozila	A (mm)	B (mm)	C (mm)	OE broj	RAPIDEX broj
	1.	B12	438	127	10 x Ø16	3112965	KOCN1379
	2.	FL4, FL6	322	90	6 x Ø14	6779208	KOCN1445
	3.	B7, B10	438	195	10 x Ø16	20515093	KOCN0126
	4.	FM7, FM9, FH12	434	45	220	3092710	KOCN0125
	5.	FM12, FH12, FH16	434	45	220	20515093	KOCN0140







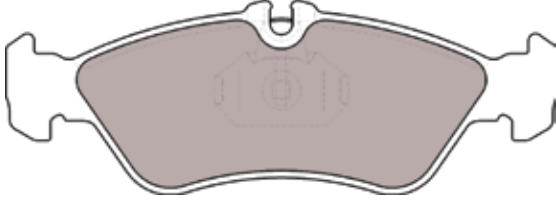
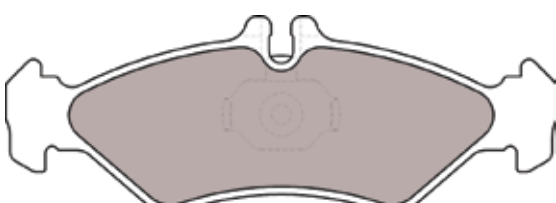
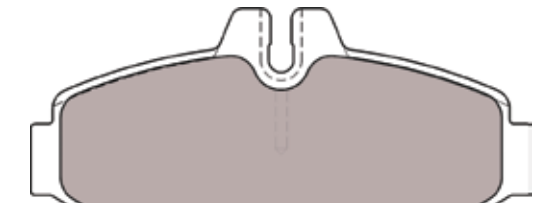
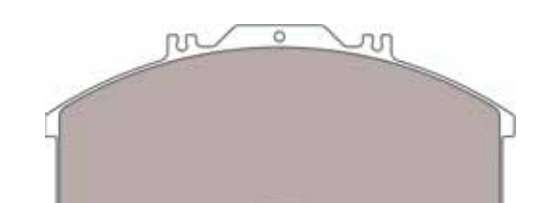
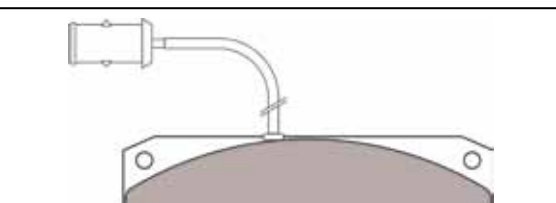

BPW							
Slika	Poz.	Tip vozila	A (mm)	B (mm)	C (mm)	OE broj	RAPIDEX broj
	1.	SB6000, SKH SERIJA	337	159,5	10 x Ø23	03.088.34.02.0	KOCN0830
	2.	SKRB	430	159,5	10 x Ø23	03.088.35.03.0	KOCN0929
	3.	SB6000, SKH SERIJA	377	159,5	10 x Ø23	03.088.34.04.0	KOCN1446
	4.	ECO	377	169,5	10 x Ø23	03.088.34.08.0	KOCN0128
	5.	SKH SERIJA	376	160	10 x Ø10	03.088.34.13.0	KOCN0324
	6.	SKH SERIJA	377	169,5	10 x Ø23	03.088.34.10.0	KOCN0593

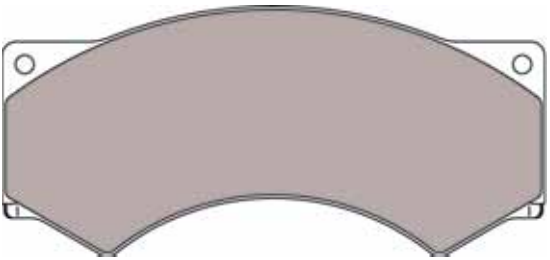

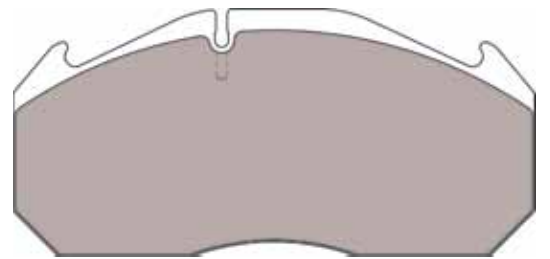

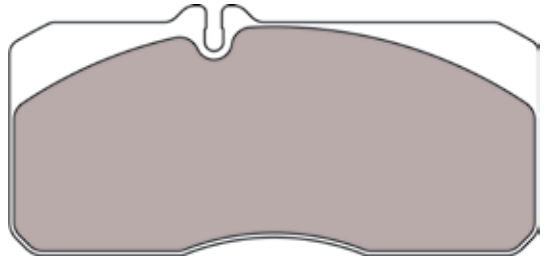

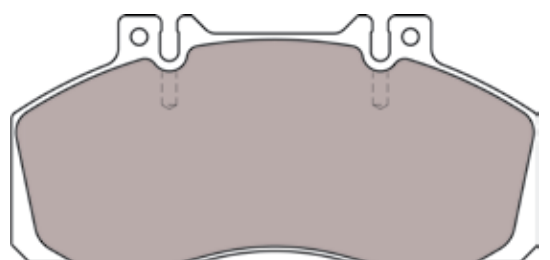

ROR							
Slika	Poz.	Tip vozila	A (mm)	B (mm)	C (mm)	OE broj	RAPIDEX broj
	1.	DX 195 (1998 - ...), TM DX 195	378	150	10 x Ø16	212 25 115	KOCN0854
	2.	TM ELSA 195	378	150	8 x Ø24	212 24 263	KOCN0592
	3.	ELSA 195	378	150	10 x Ø16	212 27 349	KOCN1447

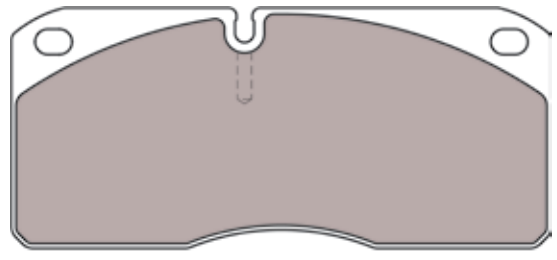
SAF							
Slika	Poz.	Tip vozila	A (mm)	B (mm)	C (mm)	OE broj	RAPIDEX broj
	1.	SKRB 9022	430	160,5	10 x Ø22,7	4.079.0005.02	KOCN0482
	2.	SKRS9019, SKRZ9019	377	157,5	10 x Ø23	4.079.0004.00	KOCN0122
	3.	SKRB9023	430	160,5	10 x Ø22,7	4.079.0005.00	KOCN0135

SAF							
Slika	Poz.	Tip vozila	A (mm)	B (mm)	C (mm)	OE broj	RAPIDEX broj
	4.	SKRB9019	375,5	139,5	45	4.079.0013.00	KOCN0227
	5.	SKRB9021	376	45	12 x Ø19	4.079.0010.00	KOCN0226
	6.	SKRB9019	375,5	139,5	37	4.079.0007.01	KOCN012
	7.	SKRB9019	430	252	37	4.079.0010.03	KOCN0017
	8.	SKRB9022 INTEGRAL 22,5	376	170	37	4.079.0013.02	KOCN0733
	9.	SKRB9019 INTEGRAL 19,5	376	170	45	4.079.0010.02	KOCN0613

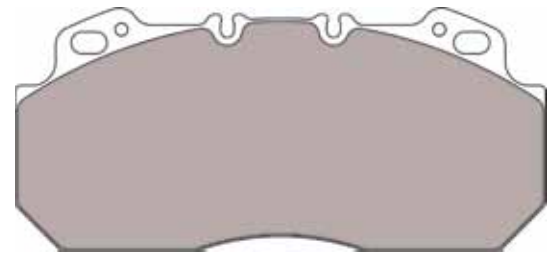
KOČIONE PLOČICE						
Slika	WVA broj		Dimenzije (mm)			RAPIDEX broj
			21592	Teves	156,3	55,4
	Poz.	Tip vozila			OE broj	
	1.	MERCEDES SPRINTER 208-214, 308-316, 408-416			002 420 60 20	
	21621	Teves	141	49	17	KOCN1449
	Poz.	Tip vozila			OE broj	
	1.	MERCEDES SPRINTER 208D-212D, 210-214CDI			002 420 56 20	
	23021	Teves	125,8	61,9	18,9	KOCN0823
	Poz.	Tip vozila			OE broj	
	1.	MERCEDES SPRINTER 308CDI, 310D, CDI314/316/408-416			000 420 97 20	
	29011	Bendix	240,4	125	25	KOCN0633
	Poz.	Tip vozila			OE broj	
	1.	IVECO EUROSTAR, EUROTECH EUROCARGO			1906191	
	29012	Teves	177	78	18	KOCN1450
	Poz.	Tip vozila			OE broj	
	1.	IVECO DAILY I			1906040	

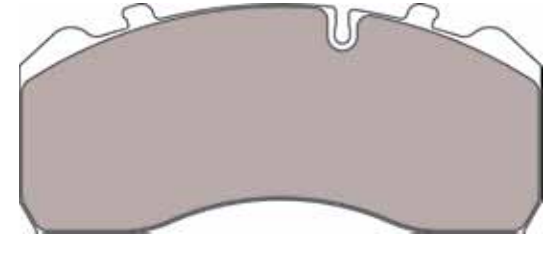
KOČIONE PLOČICE						
	WVA broj		Dimenzije (mm)			RAPIDEX broj
		29017	Wabco	191	87	23
	Poz.	Tip vozila			OE broj	
	1.	DAF 45, FA45, F1000, FA1000C, F600, FA600CD,			BBU8177	
	2.	IVECO ZETA 79-10, 79-10V, 79-14, 79-14H, 79-14V			1906345	
	WVA broj		Dimenzije (mm)			RAPIDEX broj
	29030	Meritor	249,6	118,4	28,2	KOCN0429
	Poz.	Tip vozila			OE broj	
	1.	RENAULT PREMIUM DISTRIBUTION, PREMIUM ROUTE			5001834075	
	2.	MAN F90, F2000			81.50820.6002	
	3.	RENAULT PREMIUM, PREMIUM ROUTE, MAGNUM			5001823000	
	4.	MAN L2000, M2000, F2000, TGA			81.50820.6035	
	WVA broj		Dimenzije (mm)			RAPIDEX broj
	29055	Wabco	175,8	82,5	22	KOCN0517
	Poz.	Tip vozila			OE broj	
	1.	MAN L2000			81.50804.6028	
	WVA broj		Dimenzije (mm)			RAPIDEX broj
	29065	Lukas	175	85	22	KOCN1453
	Poz.	Tip vozila			OE broj	
	1.	IVECO EUROCARGO			1906144	
	2.	RENAULT MIDLINER			5001014694	

KOČIONE PLOČICE						
	WVA broj		Dimenzije (mm)			RAPIDEX broj
		29067	Meritor	176	78	22
	Poz.	Tip vozila			OE broj	
	1.	IVECO EUROCARGO			1906297	
	2.	IVECO EUROCARGO, ZETA			1906043	
	3.	RENAULT MIDLINER			5001014704	
	WVA broj		Dimenzije (mm)			RAPIDEX broj
	29088	Wabco	175,5	85,6	26	KOCN0909
	Poz.	Tip vozila			OE broj	
	1.	DAF LF45, FA45			1436901	
	2.	MAN L2000, M2000			81.50820.5025	
	WVA broj		Dimenzije (mm)			RAPIDEX broj
	29090	Meritor	249,6	114,2	28,2	KOCN0874
	Poz.	Tip vozila			OE broj	
	1.	RENAULT PREMIUM, MAGNUM, VOLVO B12B AUTOBUS,			5001831161	
	WVA broj		Dimenzije (mm)			RAPIDEX broj
	29095	Knorr	210,7	92,5	30	KOCN1455
	Poz.	Tip vozila			OE broj	
	1.	IVECO EUROCARGO, TECTOR			2992336	
	2.	MAN M2000, TGL, TGM			81.50820.6022	
	3.	MERCEDES ATEGO, ATEGO II			002 420 78 20	

KOČIONE PLOČICE						
	WVA broj		Dimenzije (mm)			RAPIDEX broj
	29113		Meritor	249,6	118,5	28,2
Poz. Tip vozila OE broj						
1.	MAN F90, F2000, TGA			81.50820.6046		
	WVA broj		Dimenzije (mm)			RAPIDEX broj
	29124		Meritor	205,4	102	27
Poz. Tip vozila OE broj						
1.	ROR LM LM 9000 9300			15224835		
	WVA broj		Dimenzije (mm)			RAPIDEX broj
	29125		Meritor	249,5	111,2	29,2
Poz. Tip vozila OE broj						
1.	VOLVO FM9, FM10, FH			3095396		
2.	ROR LMLM9000, TA TA13000					
	WVA broj		Dimenzije (mm)			RAPIDEX broj
	29131		Meritor	249,6	118,2	30,2
Poz. Tip vozila OE broj						
1.	MAN TGA			81.50820.5073		
	WVA broj		Dimenzije (mm)			RAPIDEX broj
	29136		Meritor	175,7	89,1	29,2
Poz. Tip vozila OE broj						
1.	VOLVO FL 180-10, 180-12, 220-12, 250-12, 250-9			3093531		







KOČIONE PLOČICE						
	WVA broj		Dimenzije (mm)			RAPIDEX broj
	29137		Meritor	210,1	102,4	29,2
Poz. Tip vozila OE broj						
1.	VOLVO FL FL180-13, FL180-14, FL220-16, FL250-17			3093532		
	WVA broj		Dimenzije (mm)			RAPIDEX broj
	29143		Haldex	247,6	105	30
Poz. Tip vozila OE broj						
1.	SAF SKRB9022H			3.057.3179.00		
	WVA broj		Dimenzije (mm)			RAPIDEX broj
	29148		Knorr	173,6	84	34
Poz. Tip vozila OE broj						
1.	MERCEDES ATEGO			000 421 10 10		
	WVA broj		Dimenzije (mm)			RAPIDEX broj
	29159		Wabco	210,6	92,3	29,8
Poz. Tip vozila OE broj						
1.	DAF LF FA55			1629064		
	WVA broj		Dimenzije (mm)			RAPIDEX broj
	29165		Knorr	210,9	92,5	30
Poz. Tip vozila OE broj						
1.	BPW SKH SKHSM 9008ECO, SKH SKHM9010-15 ECOMXX, SKH SKHZF 9008 ECO			05.092.90.04.0		
2.	MERCEDES ATEGO 715, 814					

KOČIONE PLOČICE						
	WVA broj		Dimenzije (mm)			RAPIDEX broj
		29167	Knorr	247,7	109,7	30
	Poz.	Tip vozila		OE broj		
	1.	BPW SH SHSF10010-15, SH SHSF 9010 ECO, SH SHZM12010-16 ECO		09.801.06.96.0		
	WVA broj		Dimenzije (mm)			RAPIDEX broj
		29171	Knorr	210,9	108,3	30
	Poz.	Tip vozila		OE broj		
	1.	BPW SH SHSF10010-15 ECO, SH SHSF 9010SH, SHSM 901 ECO, SH SHZM901 ECO		09.801.06.95.0		
	WVA broj		Dimenzije (mm)			RAPIDEX broj
		29173	Meritor	216,2	97	29,2
	Poz.	Tip vozila		OE broj		
	1.	RENAULT MIDLUM		5001864365		
	2.	VOLVO FL, FM, FH II		20568712		
	WVA broj		Dimenzije (mm)			RAPIDEX broj
		29174	Meritor	249,6	106,9	29,2
	Poz.	Tip vozila		OE broj		
	1.	RENAULT MAGNUM		5001864363		
	2.	VOLVO FL, FM, FH II		20568711		



KOČIONE PLOČICE						
	WVA broj		Dimenzije (mm)			RAPIDEX broj
		29202	Knorr	247,7	109,5	30
	Poz.	Tip vozila		OE broj		
	1.	DAF 75CF, CF75, CF85, XF95, XF105		1617343		
	2.	IVECO EUROCARGO, EUROTECH, EUROTRAKKER, STRALIS AD/AS		2992476		
	3.	MAN TGA, TGS, TGX		81.50820.6030		
	4.	MERCEDES ATEGO, AXOR, ACTROS		004 420 60 20		
	5.	SCANIA SERIJA 4, P, G, R, T		1 734 529		
	WVA broj		Dimenzije (mm)			RAPIDEX broj
		29835	Teves	175	85	22
	Poz.	Tip vozila		OE broj		
	1.	MERCEDES VARIO		003 420 77 20		



SENZORI ISTROŠENOSTI PLOČICA

Slika	Poz.	Tip vozila	Dimenzije	OE broj	RAPIDEX broj
	1.	DAF CF65, CF75, CF85, IVECO, SCANIA	290 mm	2992666	KOCN0327
	2.	IVECO DAYLI, EUROCARGO	300 mm	1908407	KOCN0776
	3.	MAN L2000, M2000, BUS, MERCEDES ATEGO	350 mm	81.50822.6015	KOCN0231
	4.	MAN F2000	335 mm	81.50811.0004	KOCN0503
	5.	MAN TGA	370 mm	81.50822.6017	KOCN0228
	6.	MERCEDES SPRINTER	210 mm	901 540 00 17	KOCN0842

SENZORI ISTROŠENOSTI PLOČICA

Slika	Poz.	Tip vozila	Dimenzije	OE broj	RAPIDEX broj
	7.	VOLVO, RENAULT MAGNUM, PREMIUM,	250 mm	5001831161	KOCN0838
	8.	BPW SB7000, SKH SERIJA	360 mm	Z0008241	KOCN0229
	9.	BPW SH SERIJA	760 mm	Z0008242	KOCN0230

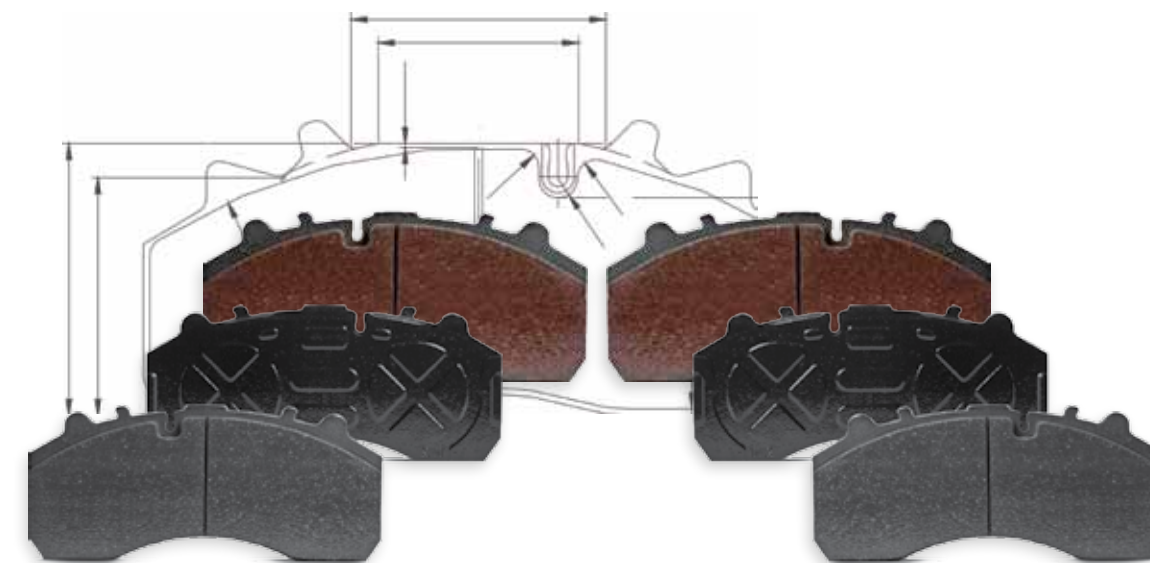



ČELJUSTI

Poz.	Tip vozila	Tip čeljusti	Proizvođač	KBP	OE broj	RAPIDEX broj
1.	DAF	22,5	KNORR	SN7167/K003808	1627244	KOCN1398
2.	DAF	PAN 22-1	WABCO	40 225 015	877933	KOCN0779
3.	DAF	PAN 22-1	WABCO	40 225 016	877934	KOCN0778
4.	DAF	PAN 17	WABCO	40 175 072	1440500	KOCN1382
5.	DAF	PAN 17	WABCO	40 175 073	1440501	KOCN1381
6.	DAF CF85	22,5	KNORR	SN7168/K003806	1627246	KOCN1397
7.	DAF CF85	22,5	KNORR	SN7178/K003805	1627247	KOCN1396
8.	DAF, SAF	PAN 19-1 PLUS	WABCO	40 195 037	877930	KOCN1119
9.	DAF, SAF	PAN 19-1 PLUS	WABCO	40 195 038	877931	KOCN1320
10.	IVECO	22,5	KNORR	SN7186RC/K003783L	CF104465E50	KOCN1153
11.	IVECO	22,5	KNORR	SN7196RC/K003784D	CF104464E50	KOCN0428

ČELJUSTI

Poz.	Tip vozila	Tip čeljusti	Proizvođač	KBP	OE broj	RAPIDEX broj
12.	IVECO		WABCO	40 468 008	0484 5537	KOCN0279
13.	IVECO EUROSTAR	22,5	KNORR	SB7682/K002709	99483108	KOCN1383
14.	IVECO EUROSTAR	22,5	KNORR	SB7692/K002708	99483109	KOCN1384
15.	IVECO STRALIS	22,5	KNORR	SN7042/K013161	41211269	KOCN1391
16.	IVECO STRALIS	22,5	KNORR	SN7042/K01360	41211270	KOCN1392
17.	IVECO EUROCARGO, TEKKTOR, STRALIS	22,5	KNORR	SN7066/K004579	41211286	KOCN1389
18.	IVECO EUROCARGO, TEKKTOR, STRALIS	22,5	KNORR	SN7076/K004578	41211287	KOCN1390
19.	MAN L2000 STARI TIP PREDNJA LEVA	1000 V-G	WABCO	40 100 001	81.50804.6017	KOCN0988
20.	MAN L-2000 STARI TIP PREDNJA DESNA	1000 V-G	WABCO	40 100 002	81.50804.6018	KOCN0987
21.	MAN L2000 NOVI TIP PREDNJA/ZADNJA LEVA 1996-	PAN 17	WABCO	40 175 049	81.50804.6087	KOCN0887
22.	MAN L2000 NOVI TIP PREDNJA/ZADNJA DESNA 1996-	PAN 17	WABCO	40 175 050	81.50804.6088	KOCN0411
23.	MAN F90, F2000 PREDNJA LEVA	22,5	MERITOR	LRG524	81.50804.6063	KOCN1406
24.	MAN F90, F2000 PREDNJA DESNA	22,5	MERITOR	LRG525	81.50804.6064	KOCN1766
25.	MAN F90/F2000 PREDNJA LEVA	22,5	MERITOR	LRG570	81.50804.6201	KOCN0580
26.	MAN F90/F2000 PREDNJA DESNA	22,5	MERITOR	LRG571	81.50804.6202	KOCN0581
27.	MAN TGA	22,5	MERITOR	LRG544	81.50804.6311	KOCN0265
28.	MAN TGA	22,5	MERITOR	LRG545	81.50804.6138	KOCN1767
29.	MAN TGA PREDNJA LEVA	22,5	MERITOR	LRG586	81.50804.6285	KOCN0586
30.	MAN TGA PREDNJA DESNA	22,5	MERITOR	LRG587	81.50804.6284	KOCN0587
31.	MAN TGA ZADNJA LEVA	22,5	MERITOR	LRG588	81.50804.6291	KOCN0574

ČELJUSTI						
Poz.	Tip vozila	Tip čeljusti	Proizvođač	KBP	OE broj	RAPIDEX broj
32.	MAN TGA ZADNJA DESNA	22,5	MERITOR	LRG589	81.50804.6290	KOCN0573
33.	MAN TGA ZADNJA DESNA	22,5	MERITOR	LRG638	81.50804.6321	KOCN0294
34.	MAN TGA ZADNJA LEVA	22,5	MERITOR	LRG639	81.50804.6322	KOCN0160
35.	MAN SG-313	22,5	MERITOR	LRG 574	81.50804.6197	KOCN1402
36.	MAN SC-313	22,5	MERITOR	LRG 575	81.50804.8198	KOCN1403
37.	MERCEDES ACTROS BPW	22,5	KNORR	SN7189RC/K003871	942 420 42 01	KOCN0497
38.	MERCEDES ACTROS BPW	22,5	KNORR	SN7211/K003800	942 420 16 01	KOCN1404
39.	MERCEDES ATEGO	17,5	KNORR	SN5016/SB5013	970 420 21 01	KOCN0737
40.	MERCEDES ATEGO	17,5	KNORR	SB5003/K004572	970 420 05 01	KOCN0637
41.	MERCEDES ATEGO NOVI TIP	19,5	KNORR	SN6567RC/K003792		KOCN1401
42.	MERCEDES VARIO	16	MERITOR	LRG624	001 420 34 01	KOCN0262
43.	MERCEDES VARIO	16	MERITOR	LRG625	001 420 35 01	KOCN0263
44.	SCANIA	22,5	KNORR	SN7208RC/K003813	1 756 385	KOCN1399
45.	SCANIA	22,5	KNORR	SN7218RC/K003814	1 756 384	KOCN1400
46.	SCANIA 124 / BUS	22,5	KNORR	SB7203RC/K003803	1 363 748	KOCN1395
47.	SCANIA 124 / BUS	22,5	KNORR	SB7213RC/K003804	1 363 749	KOCN1394
48.	VOLVO FL, FM, FH	22,5	MERITOR	LRG536	204024802	KOCN1387
49.	VOLVO FL, FM, FH	22,5	MERITOR	LRG537	204024803	KOCN1389
50.	VOLVO FH	22,5	MERITOR	LRG598		KOCN1712
51.	VOLVO FH	22,5	MERITOR	LRG599	20424071	KOCN1386
52.	SAF / BPW	22,5	KNORR	SK7052RC/K012634		KOCN0266
53.	SAF / BPW	22,5	KNORR	SK7042RC/K012633		KOCN0267
54.	SAF	22,5	KNORR	SB7810/K003781	942 420 40 01	KOCN1405
55.	SAF	22,5	KNORR	SB7800/K003782		KOCN1501
56.	SCHIMTZ MERCEDES OSOVINA	22,5	KNORR	SN7201RC/K003799	942 420 24 01	KOCN0898
57.	SCHIMTZ MERCEDES OSOVINA	22,5	KNORR	SN7195RC/K003782	942 420 25 01	KOCN0509



REPARACIONI SETOVI KOČIONIH ČELJUSTI					
Poz.	Naziv	KBP		Tip čeljusti	RAPIDEX broj
1.	REPARACIONI SET PAN-19	12999738VT	WABCO	40 195 002 40 195 004	KOCN0540
2.	REPARACIONI SET ČELJUSTI	12999776	WABCO	40 195 017 40 195 018	KOCN0824
3.	REPARACIONI SET ČELJUSTI	12999755	WABCO	40 195 001 40 195 002	KOCN0949
4.	REPARACIONI SET ČELJUSTI	12999580	WABCO	40 175 025 40 175 026	KOCN1112
5.	SET POTISKIVAČA SA KLIZAČIMA ČELJUSTI	MCK1171	MERITOR	DX.195.51 DX.195.52	KOCN0384
6.	SET POTISKIVAČA ČELJUSTI	MCK1192	MERITOR	DX.195.51 DX.195.52	KOCN0383
7.	SET KLIZAČA ČELJUSTI	MCK1102	MERITOR	LRG542 LRG543	KOCN0379
8.	SET KLIZAČA ČELJUSTI	MCK1243	MERITOR	LRG744 LRG745	KOCN0569
9.	SET KLIZAČA ČELJUSTI	MCK 1102	MERITOR	LRG537 LRG653	KOCN0570

REPARACIONI SETOVI KOČIONIH ČELJUSTI

Poz.	Naziv	KBP		Tip čeljusti	RAPIDEX broj
10.	SET KLIZAČA ČELJUSTI	MCK1254	MERITOR	LRG592 LRG564	KOCN0567
11.	REPARACIONI SET ČELJUSTI	MCK1102	MERITOR	LRG704 LRG705	KOCN0385
12.	REPARACIONI SET ČELJUSTI	CKSK 104	MERITOR	SB6/SN7	KOCN1131
13.	REPARACIONI SET ČELJUSTI	CKSK 101	MERITOR	SB6/SN7	KOCN1136
14.	REPARACIONI SET ČELJUSTI	MCK1243	MERITOR	LRG744 LRG745	KOCN1409
15.	SET POTISKIVAČA ČELJUSTI	K010603	KNORR	SB7/SN7	KOCN0764
16.	SET POTISKIVAČA ČELJUSTI	K010604	KNORR	SB7/SN7	KOCN1000
17.	SET KLIZAČA ČELJUSTI	II328090062	KNORR	SB6503	KOCN0234
18.	SET KLIZAČA ČELJUSTI	K000472	KNORR	SN7/SB6	KOCN0264
19.	REPARACIONI SET ČELJUSTI	K00696	KNORR	SB6/SN7	KOCN0350
20.	REPARACIONI SET ČELJUSTI	CKSK 8.1	KNORR	SB6/SB7 SN6/SN7	KOCN0351
21.	REPARACIONI SET ČELJUSTI	K00375	KNORR	SB 6503	KOCN0920
22.	REPARACIONI SET ČELJUSTI	K000132	KNORR		KOCN1408



DAF

Slika	Poz.	Tip vozila	Dimenzije (mm)			OE broj	RAPIDEX broj
	1.	F95	419,3	166	227	1233462	KOCN1221
	2.	F95	420	216	288	365579	KOCN0427
	3.	CF75, CF85	420	216,5	287	368829	KOCN1412

IVECO

Slika	Poz	Tip vozila	Dimenzije (mm)			OE broj	RAPIDEX broj
	1.	STRALIS, EUROSTAR	381	190	271	02479853	KOCN0025
	2.	EUROSTAR, EUROCARGO, EUROTECH, EUROTRAKKER	410	202	258	07172079	KOCN1413
	3.	STRALIS, BUS	410	190	250	07172329	KOCN1414



MAN							
Slika	Poz.	Tip vozila	Dimenzije (mm)			OE broj	RAPIDEX broj
	1.	F90, F2000	410	188	232	81.50110.0272	KOCN0819
	2.	F2000 TGA	410	232	300	81.50110.0144	KOCN0930
	3.	F90 TGA	410	192	280	81.50110.0101	KOCN0780
	4.	L2000 M2000	360	182	247	81.50110.0237	KOCN0302
	5.	L2000 M2000 F2000	410	188	232	81.50110.0214	KOCN0669
	6.	F2000 TGA	410	173	250	81.50110.0242	KOCN1415



MAN							
Slika	Poz.	Tip vozila	Dimenzije (mm)			OE broj	RAPIDEX broj
	7.	F2000 TGS, TGX,	410	180	232	81.50110.0232	KOCN0668
	8.	TGA TGM	410	160	250	81.50110.0213	KOCN1416
	9.	F90, F2000, TGA	410	192	280	81.50110.0279	KOCN1417

MERCEDES							
Slika	Poz.	Tip vozila	Dimenzije (mm)			OE broj	RAPIDEX broj
	1.	SK ACTROS	410	238	306	305 423 04 01	KOCN1135
	2.	SK MK	370	184	210	305 421 04 01	KOCN0907
	3.	SK	410	191	237	658 421 00 01	KOCN1418



MERCEDES							
Slika	Poz.	Tip vozila	Dimenzije (mm)			OE broj	RAPIDEX broj
	4.	ATEGO	364	142	193	677 421 04 01	KOCN0966
	5.	SK NK	410	172	250	387 421 0 01	KOCN1092
	6.	MB SK	410	172	270	346 423 06 01	KOCN0424
	7.	SK ACTROS	410	192	280	346 423 05 01	KOCN1359
	8.	MK NG	410	172	248	385 423 03 01	KOCN1419
	9.	ATEGO	364	170	210	677 423 05 01	KOCN1266



MERCEDES							
Slika	Poz.	Tip vozila	Dimenzije (mm)			OE broj	RAPIDEX broj
	10.	814	308	120	293	673 356 12 02	KOCN1420
	11.	MK, NG	410	238	306	307 423 01 01	KOCN0931
	12.	NG	410	335	280	381 423 00 01	KOCN1421
	13.	814	308	147	293	674 356 13 02	KOCN1422



SCANIA							
Slika	Poz	Tip vozila	Dimenzije (mm)			OE broj	RAPIDEX broj
	1.	124, 144	413	216	296	360572	KOCN0535
	2.	124, 144	413	214	275,5	1 414 153	KOCN0534

SCANIA							
Slika	Poz	Tip vozila	Dimenzije (mm)			OE broj	RAPIDEX broj
	3.	T114, T124	413	266	321	1 414 435	KOCN1423
	4.	T94, T124	413	189	263	1 414 152	KOCN1424

VOLVO							
Slika	Poz	Tip vozila	Dimenzije (mm)			OE broj	RAPIDEX broj
	1.	FH12, FM12	410	190	262	1599009	KOCN0533
	2.	FH12, FL10	410	220	295	1599012	KOCN1425
	3.	FH12, FH16	410	210	273	3171745	KOCN1426
	4.	FM9, FL10	410	199	260	1075309	KOCN1427

BPW							
Slika	Poz	Tip vozila	Dimenzije (mm)			OE broj	RAPIDEX broj
	1.	SH ECO	420	192	229	03.109.67.82.0	KOCN1430
	2.	SB 6000	420	200	277	03.106.77.04.0	KOCN0058
	3.	SH ECO	420	180	226	03.109.67.19.0	KOCN0591
	4.	SH ECO	420	194	246	03.106.67.12.0	KOCN0670
	5.	SKH SERIJA	420	200	287	03.109.77.72.0	KOCN1428
	6.	SH ECO	412	194	246	03.106.67.36.0	KOCN1429
	7.	SB6000	420	200	277	03.106.77.57.0	KOCN0600

BPW							
Slika	Poz	Tip vozila	Dimenzije (mm)			OE broj	RAPIDEX broj
	8.	SH ECO	420	192	229	03.106.67.13.0	KOCN0783
	9.	SKH SERIJA	412	194	246	03.106.67.40.0	KOCN1431

ROR							
Slika	Poz	Tip vozila	Dimenzije (mm)			OE broj	RAPIDEX broj
	1.	ROR-LM	419	187	237	212 20 183 V	KOCN0152
	2.	ROR-TM	311	207	260,5	212 09 723 S	KOCN0579



SAF							
Slika	Poz	Tip vozila	Dimenzije (mm)			OE broj	RAPIDEX broj
	1.	SKRB	420	196	227	1.064.0260.02	KOCN0733
	2.	SKRS	420	212	256	1.064.0261.01	KOCN0183
	3.	SKRB	420	190	260	1.064.0236.00	KOCN1423
	4.	SKRB	367	194	225	1.064.0280.00	KOCN1434
	5.	SKRS	420	193	255	1.064.0260.01	KOCN1433
	6.	RSM&RZM	420	193	255	1.064.0270.00	KOCN0721
	7.	SKRB	367	180	225	1.064.0280.01	KOCN0644



NOSAČI KOČIONIH OBLOGA

Poz.	Tip vozila	Dimenzije	OE broj	RAPIDEX broj
1.	DAF XF95/95XF/BUS	150 mm	1246530	OSOV0240
2.	DAF 75/85CF, XF95	175 mm	1246531	OSOV0241
3.	DAF 75/85CF, XF95, 95XF	200 mm	1246532	OSOV0242
4.	MAN F90/M90	180 mm	81.50201.6178	OSOV0248
5.	MAN F90, F2000	220 mm	81.50201.6218	OSOV0249
6.	MAN F90, F2000	410 x 183 mm	81.50220.0524	OSOV0250
7.	MAN NG, NL, NGT, SL, SG	410 x 223 mm	81.50221.0236	OSOV0251
8.	MERCEDES ACTROS, MK, NG, SK	180 mm	659 420 06 19	OSOV0243
9.	MERCEDES ACTROS, AXOR, SK, MK, UNIMOG	160 mm	659 420 00 19	OSOV0244

NOSAČI KOČIONIH OBLOGA

Poz.	Tip vozila	Dimenzije	OE broj	RAPIDEX broj
10.	MERCEDES SPRINTER /2-3T/	40/160 mm	002 420 58 20	OSOV0372
11.	MERCEDES NG, SK	160 mm	393 420 03 19	OSOV0054
12.	MERCEDES ATEGO, MK, SK, NG	410 x 160 mm	305 421 00 10	OSOV0245
13.	MERCEDES ACTRO MP2, MK, SK, NG	410 x 183 mm	346 423 96 10	OSOV0246
14.	MERCEDES SK, MK	220 mm	659 420 05 19	OSOV0247
15.	SCANIA SERIJA 4, 94,114,144,124	203 mm	1 104 544	OSOV0252
16.	SCANIA SERIJA 2, 3, 4, P, G, R, T	178 mm	1 104 543	OSOV0253
17.	SCANIA SERIJA 2, 3, 4, P, G, R, T	254 mm	1 104 545	OSOV0254
18.	VOLVO FH12, 13, 16, FM9, 10, 12	410 x 125 mm	3090073	OSOV0255
19.	VOLVO FH12, 13, 16, FM9, 10, 12	410 x 150 mm	3090074	OSOV0256
20.	VOLVO FH12, 13, 16, FM9, 10, 12	410 x 175 mm	3090075	OSOV0257
21.	VOLVO FH12, 13, 16, FM9, 10, 12	410 x 200 mm	3095196	OSOV0258
22.	VOLVO FM12, 13, 16, FM9, 10, 12	410 x 225 mm	3095197	OSOV0259
23.	BPW H HZVB, H HZM	420 x 180 mm	05.091.46.17.0	OSOV0331
24.	BPW SKH SKHSM	420 x 200 mm	05.091.27.54.2	OSOV0260
25.	BPW ECO MAX	420 x 180 mm	05.091.26.64.2	OSOV0008
26.	BPW NH/NRZD 9010 OD 1995	300 x 200 mm	03.092.14.12.0	OSOV0261
27.	BPW KH/KRZD 9010 OD 1995	360 x 200 mm	03.092.19.08.0	OSOV0262
28.	SAF RSM/RZM	420 x 180 mm	3.055.0052.00	OSOV0263
29.	SAF RSM/RZM	420 x 220 mm	3.055.0053.00	OSOV0264
30.	SAF RSM/RZM	300 x 200 mm	3.055.0048.00	OSOV0265
31.	SAF SK 500	420 x 180 mm	3.054.0120.00	OSOV0144



DAF							
	WVA broj	∅ mm				OE broj	RAPIDEX broj
	19010	420	150	181	8	683274	
	19010 2080						KOCN1549
	19010 2180						KOCN1550
Tip vozila							
F2300, F2500, CF65/75/85, 95XF							

DAF							
	WVA broj	∅ mm				OE broj	RAPIDEX broj
	19052	420	175	181	12	682421	
	19052 2070						KOCN1552
	19052 2170						KOCN1568
Tip vozila							
CF75, 85, 75FAG, 95XF, F2100							

DAF							
	WVA broj	∅ mm				OE broj	RAPIDEX broj
	19063	420	200	180	16	356501	
	19063 2070						KOCN1577
	19063 2170						KOCN1578
Tip vozila							
CF65, CF75, CF85, 95FTT, 95XF, F2300, F2900							

DAF							
	WVA broj	∅ mm				OE broj	RAPIDEX broj
	19620	325	150	209	14	313746	
	19620 1250						KOCN1579
	19620 1350						KOCN1581
Tip vozila							
F1100FA, F900							

DAF							
	WVA broj	∅ mm				OE broj	RAPIDEX broj
	19900	420	150	177	8	682845	
	19900 1910						KOCN1582
	19900 2010						KOCN1583
Tip vozila							
95FA, 95FAD, 95FTT, F1900, F2100							

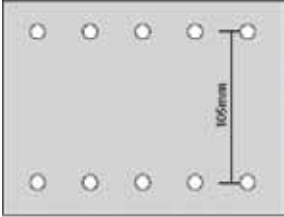
IVECO							
	WVA broj	\varnothing mm				OE broj	RAPIDEX broj
	19116	400	200	204	10	2992126	
	19116 2100						KOCN1584
	19116 2200						KOCN1585
Tip vozila							
EUROTRAKKER							

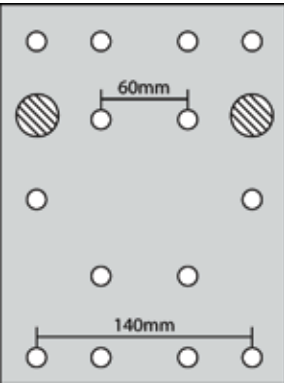
IVECO							
	WVA broj	\varnothing mm				OE broj	RAPIDEX broj
	19343	410	200	203	14	1906202	
	19343 2050						KOCN1586
	19343 2150						KOCN1587
Tip vozila							
EUROSTAR, EUROTRAKKER, EUROTECH							

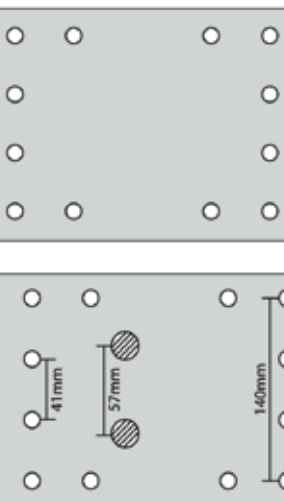
IVECO							
	WVA broj	\varnothing mm				OE broj	RAPIDEX broj
	19384	381	177	189	12	1902185	
	19384 1800						KOCN1590
	19384 1900						KOCN1591
19384 2000						KOCN1592	
Tip vozila							
EUROCARGO, TURBOSTAR							

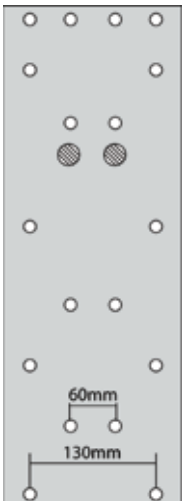
IVECO							
	WVA broj	\varnothing mm				OE broj	RAPIDEX broj
	19503	360	170	314	18	1906221	
	19503 1640						KOCN1593
	19503 1740						KOCN1594
19503 1840						KOCN1595	
Tip vozila							
EUROCARGO							

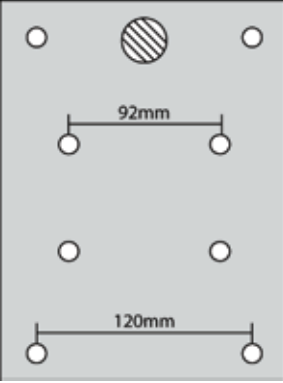
MAN, MERCEDES								
	WVA broj	\varnothing mm				OE broj	RAPIDEX broj	
	19494		410	163	178	8	81.50221.6094 617 423 18 30	
	19494 1700							KOCN0390
	19494 1830							KOCN0391
19494 1910							KOCN0392	
Tip vozila								
1.	MAN F90, M90, M2000, L2000							
2.	MERCEDES ATEGO, ATEGO 2, MK, NG, SK							

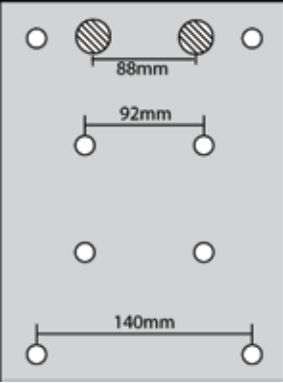
MAN, MERCEDES								
	WVA broj	\varnothing mm				OE broj	RAPIDEX broj	
	19495		410	183	178	8	81.50221.6098 659 423 40 10	
	19495 1700							KOCN0356
	19495 1830							KOCN0357
19495 1910							KOCN0358	
Tip vozila								
1.	MAN F90, F2000, M90, M2000, L2000							
2.	MERCEDES ACTROS, ATEGO, MK, SK							

MAN, MERCEDES								
	WVA broj	∅ mm				OE broj	RAPIDEX broj	RAPIDEX broj
	19496		410	223	178	8	81.50220.0632 659 423 36 10	
	19496 1700							KOCN1176
	19496 1830							KOCN0355
	19496 1910							KOCN0224
Tip vozila								
1.	MAN F90, F2000, EL, EM							
2.	MERCEDES ACTROS, ACTROS MP2, ATEGO, MK, SK							

MAN							
	WVA broj	∅ mm				OE broj	RAPIDEX broj
	15879	325	99,5	143	6	81.50221.0584	
	15879 1650						KOCN1614
	15879 1725						KOCN1615
Tip vozila							
G90, L2000							

MAN							
	WVA broj	∅ mm				OE broj	RAPIDEX broj
	17988	325	149,5	143	8	81.50221.0587	
	17988 1625						KOCN1616
	17988 1725						KOCN1617
Tip vozila							
G90, L2000							

MAN								
	WVA broj	∅ mm				OE broj	RAPIDEX broj	
	19708	360	182,5	174,3	12	81.50221.6070		
	19708 1625						KOCN1618	
	19708 1740						KOCN1619	
	19708 1810						KOCN1620	
Tip vozila								
M2000L, M2000M								

MAN							
	WVA broj	∅ mm				OE broj	RAPIDEX broj
	19713	410	163	173	8	81.50221.0922	
	19713 1700						KOCN1621
	19713 1830						KOCN1622
Tip vozila							
F90, M90, M2000, L2000							

MERCEDES							
	WVA broj	∅ mm				OE broj	RAPIDEX broj
	17409	304	135	247	10	316 421 19 10	
	17409 1030						KOCN1623
	17409 1230						KOCN1624
Tip vozila							
O309, AUTOBUS							

MERCEDES							
	WVA broj	∅ mm				OE broj	RAPIDEX broj
	19505	364	200	174	8	675 421 29 30	
	19505 1550						KOCN1625
	19505 1630						KOCN1626
Tip vozila							
LK/ N2, ATEGO, ATEGO2							

MERCEDES							
	WVA broj	∅ mm				OE broj	RAPIDEX broj
	19506	364	160	174	8	675 421 08 30	
	19506 1550						KOCN1627
	19506 1630						KOCN1628
Tip vozila							
LK/LN2 , ATEGO, ATEGO2, O301, O402							

MERCEDES							
	WVA broj	∅ mm				OE broj	RAPIDEX broj
	19707	410	222	173	8	357 423 79 10	
	19707 1797						KOCN1629
	19707 1897						KOCN1630
Tip vozila							
O303, O305, O307, O407, O408							

RENAULT							
	WVA broj	∅ mm				OE broj	RAPIDEX broj
	19187	414	220	204	10	5001019222	
	19187 1850						KOCN1631
	19187 2000						KOCN1633
Tip vozila							
MAGNUM AE, PREMIUM DISTRIBUTION							

RENAULT							
	WVA broj	∅ mm				OE broj	RAPIDEX broj
	19935	414	175	185	8	5000288508	
	19935 1850						KOCN1634
	19935 2000						KOCN1635
Tip vozila							
MIDLINER, MANAGER, MAJER, KERAX							

SCANIA							
	WVA broj	∅ mm				OE broj	RAPIDEX broj
	17161	413	127	193	8	551010	
	17161 1900						KOCN1637
	17161 2000						KOCN1641
17161 2100						KOCN1642	
Tip vozila							
SERIJA 2 T142, R142, 112H, 82M, 94M							

SCANIA							
	WVA broj	\varnothing mm				OE broj	RAPIDEX broj
	19393	413	203	189	12	551059	
	19393 1900						KOCN1644
	19393 2000						KOCN1647
Tip vozila							
SERIJA 2 T142, R142, 112H, 82M, 94M							

SCANIA							
	WVA broj	\varnothing mm				OE broj	RAPIDEX broj
	19931	413	178	235	16	1 535 248	
	19931 1900						KOCN1648
	19931 2000						KOCN1662
Tip vozila							
SERIJA 3 113, 143, 93, T113, SERIJA 4 114, 124, 144, 164, T114, T124							

SCANIA							
	WVA broj	\varnothing mm				OE broj	RAPIDEX broj
	19932	413	203	235	16	511124	
	19932 1900						KOCN1663
	19932 2000						KOCN1664
Tip vozila							
T142, R142, R124, R164, T113							

SCANIA							
	WVA broj	\varnothing mm				OE broj	RAPIDEX broj
	19933	413	254	193	12	1 535 250	
	19933 1900						KOCN1666
	19933 2000						KOCN1667
Tip vozila							
SERIJA 3 93, T93, T113, T143, SERIJA 4 94, 114, 124, 144, 164, T124, T144							

VOLVO							
	WVA broj	\varnothing mm				OE broj	RAPIDEX broj
	17992	410	123	178	8	3095173	
	17992 1840						KOCN1668
	17992 1990						KOCN1671
Tip vozila							
F12, F16, FH12, FH16, FL7, FL10, FM12							

VOLVO							
	WVA broj	\varnothing mm				OE broj	RAPIDEX broj
	19068	410	223	177,2	14	3095181	
	19068 1800						KOCN1673
	19068 1940						KOCN1675
Tip vozila							
F10, F12, F16, FH12, FH16, FL122, FM12							

VOLVO						
WVA broj	∅ mm				OE broj	RAPIDEX broj
19071	410	198	177,2	14	3095179	
19071 1800						KOCN1676
19071 1940						KOCN1677
Tip vozila						
F10, F12, F16, FH12, FH16, FL7, FL10						

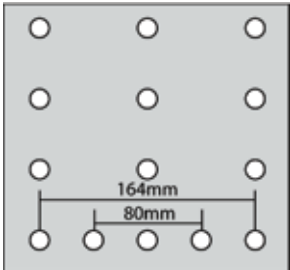

VOLVO						
WVA broj	∅ mm				OE broj	RAPIDEX broj
19941	410	150	177	12	3095175	
19941 1800						KOCN0213
19941 1940						KOCN1687
Tip vozila						
F10, F12, FL7, FL10, FL12						

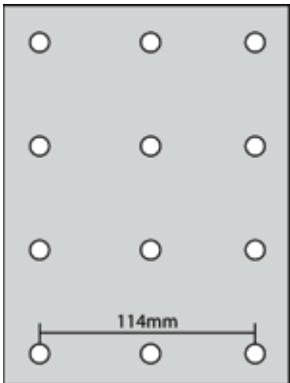

BPW, SAF						
WVA broj	∅ mm				OE broj	RAPIDEX broj
19032	420	180	204	10	03.092.26.01.0 3.057.3112.0	
19032 1800						KOCN0586
19032 1900						KOCN0605
19032 2000						KOCN0010
Tip vozila						
H HZVB, H HZM						

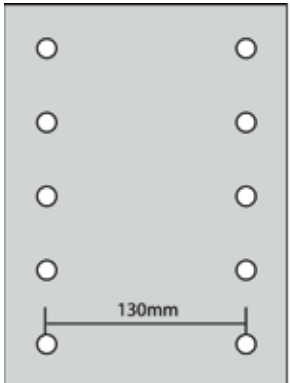

BPW, SAF						
WVA broj	∅ mm				OE broj	RAPIDEX broj
19094	420	200	204	10	03.092.27.63.0 3.057.0013.0	
19094 1800						KOCN0628
19094 1900						KOCN0011
19094 2000						KOCN0012
Tip vozila						
EH EHF, EH EHI, H HSM						

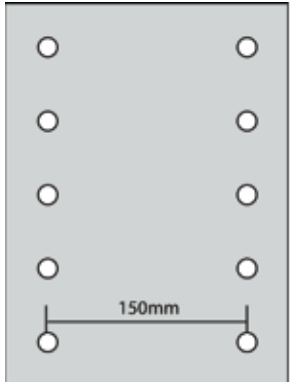

SAF						
WVA broj	∅ mm				OE broj	RAPIDEX broj
19283	420	180	189	8	1.057.0060.00	
19283 2050						KOCN0588
19283 2150						KOCN0587
19283 2250						KOCN1711
Tip vozila						
RSM&RZM, SKRZ, SKRS						

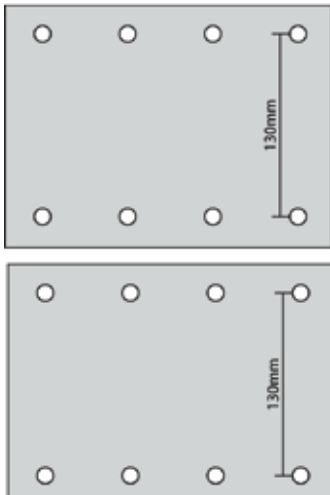

SAF						
WVA broj	∅ mm				OE broj	RAPIDEX broj
19477	420	203	189	8	3.057.3966.00	
19477 2050						KOCN0620
19477 2150						KOCN0619
Tip vozila						
RSM, RZM, SKRS, SKRLS, WRZM						

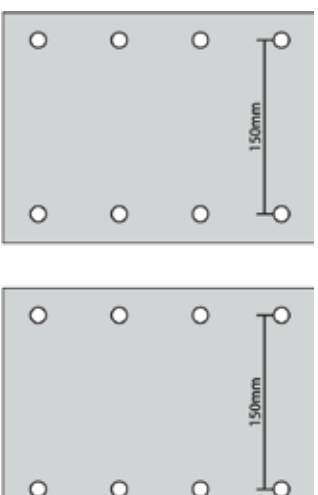

SAF						
WVA broj	∅ mm				OE broj	RAPIDEX broj
19479	367	180	179	8	1.057.0068.00	
19479 2060						KOCN1688
Tip vozila						
SKRS						

SAF						
WVA broj	∅ mm				OE broj	RAPIDEX broj
19490	367	200	179	8	3.057.3170.00	
19490 2060						KOCN0156
Tip vozila						
RSM, RZM, SKRS						

NITNE ZA OBLOGE					
Tip vozila	Dimenzije	Set	KBP	RAPIDEX broj	
BPW, SAF	∅8 x 15 mm	100 kom	96000 0044	KOCN0634	
MAN, MERCEDES	∅8 x 18 mm	100 kom	96000 0045	KOCN0388	

ANKER PLOČE				
Slika	Poz.	Tip vozila	OE broj	RAPIDEX broj
	1.	BPW H/R	03.10.98.13.0	OSOV0373
	2.	BPW H/R	99.000.00.04.0	OSOV0374
	3.	BPW NH/NR	99.000.00.09.3	OSOV0011
	4.	BPW NH/NR	99.000.00.08.8	OSOV0375
	5.	BPW NH/NR	99.000.00.0.71	OSOV0010
	6.	BPW NH/NR	99.000.00.08.0	OSOV0012



ANKER PLOČE				
Slika	Poz.	Tip vozila	OE broj	RAPIDEX broj
	7.	BPW NH/NR	99.00.000.08.3	OSOVO376
	8.	BPW NH/NR	99.0000.00.42	OSOVO377
	9.	BPW NH/NR	99.000.00.10.5	OSOVO378
	10.	FRUEHOF P/PS/PSL	A-JA0483-001	OSOVO379
	11.	ROR T 9000	212 20 647	OSOVO380
	12.	ROR T 9000	212 24 522	OSOVO381



ANKER PLOČE				
Slika	Poz.	Tip vozila	OE broj	RAPIDEX broj
	13.	ROR T 9000	210 08 062	OSOVO382
	14.	SAF RSM&RZM	3.005.0171.00	OSOVO383
	15.	SAF RSM&RZM	3.005.0141.00	KOCN624
	16.	SAF RSM&RZM	3.005.0173.00	KOCN625
	17.	SAF SKRS	3.005.0147.00	OSOVO148
	18.	SAF SKRS	3.005.0117.00	OSOVO373



ANKER PLOČE				
Slika	Poz.	Tip vozila	OE broj	RAPIDEX broj
	19.	SAF SKRS	3.005.0009.02	OSO0374
	20.	SCANIA	1 378 432	OSO0375
	21.	SCANIA	1 378 431	OSO0376
	22.	SCANIA	375329	OSOC0377
	23.	TRAILOR	6502809R	OSO0378
	24.	TRAILOR	M002904	OSO0379

ANKER PLOČE				
Slika	Poz.	Tip vozila	OE broj	RAPIDEX broj
	25.	VOLVO	1629835	OSO0380
	26.	VOLVO	2036734	OSO0381
	27.	VOLVO	1629836	OSO0382
	28.	VOLVO	1629834	OSO0383



DAF							
Slika	Poz.	Tip vozila	Broj zuba	Oсно rastojanje (mm)	Haldex broj	OE broj	RAPIDEX broj
	1.	65/75/85CF, 95XF	10	140	72523C	278350	KOCN1457
	2.	65/75/85CF, 95XF	10	140	72524C	278351	KOCN1458
	3.	75/85CF, 95XF	10	165	72538C	361544	KOCN1459
	4.	75/85CF, 95XF	10	165	72539C	361543	KOCN1460
	5.	65/75/85CF, 95XF	10	165	72542C	361541	KOCN1461
	6.	65/75/85CF, 95XF	10	165	72543C	361542	KOCN1462

DAF							
Slika	Poz.	Tip vozila	Broj zuba	Oсно rastojanje (mm)	Haldex broj	OE broj	RAPIDEX broj
	7.	F75/85/95, CF75/85, 95XF, BUS	10	140	72535C	159565	KOCN1463
	8.	75/85/95F, 75/85CF, 95XF	10	140	72834C	1242598	KOCN1464



MAN							
Slika	Poz.	Tip vozila	Broj zuba	Oсно rastojanje (mm)	Haldex broj	OE broj	RAPIDEX broj
	1.	TGA, TGS, TGM, TGX	26	145	80183C	81.50610.6266	KOCN0546
	2.	TGA, TGS, TGX, TGM	26	145	80176C	81.50610.6263	KOCN1466
	3.	TGA, TGX, TGS, TGM	26	145	80178C	81.50610.6259	KOCN1335



MAN							
Slika	Poz.	Tip vozila	Broj zuba	Oso rastojanje (mm)	Haldex broj	OE broj	RAPIDEX broj
	4.	TGA, TGX, TGM, TGS	26	145	80179C	81.50610.6260	KOCN0508
	5.	TGA, TGM, TGX, TGS	26	145	80180C	81.50610.6261	KOCN1467
	6.	TGA, TGS, TGM, TGX	26	145	80181C	81.50610.6262	KOCN1468
	7.	M90, M2000	26	145	79207C	81.50610.6217	KOCN1469
	8.	F90 F2000, M2000	26	145	79208C	81.50610.6211	KOCN1470
	9.	F90 F2000,	26	215	79223C	81.50610.6220	KOCN1471

MAN							
Slika	Poz.	Tip vozila	Broj zuba	Oso rastojanje (mm)	Haldex broj	OE broj	RAPIDEX broj
	10.	F90 F2000,	26	215	79224C	81.50610.6221	KOCN1472
	11.	F90 F2000,	26	145	79209C	81.50610.6210	KOCN1473
	12.	F90, F2000, M2000	26	145	72173C	81.50610.6234	KOCN1474
	13.	F90 F2000, M90, M2000,	26	145	79210C	81.50610.6083	KOCN1475
	14.	F90 F2000, M90, M2000, L2000	26	145	79211C	81.50610.6154	KOCN1502
	15.	F90 F2000, M90, M2000	26	145	79212C	81.50610.6151	KOCN1476



4



4

MAN							
Slika	Poz.	Tip vozila	Broj zuba	Osnovno rastojanje (mm)	Haldex broj	OE broj	RAPIDEX broj
	16.	F90 F2000, M90, M2000	26	145	79205C	81.50610.6176	KOCN0516
	17.	F90 F2000	26	145	79203C	81.50610.6183	KOCN0716

MERCEDES							
Slika	Poz.	Tip vozila	Broj zuba	Osnovno rastojanje (mm)	Haldex broj	OE broj	RAPIDEX broj
	1.	ACTROS, AXOR, MK, NG, ATEGO	26	145	80008C	942 420 09 38	KOCN1078
	2.	ACTROS, AXOR, ATEGO, MK, NG	26	145	80009C	942 420 08 38	KOCN1477
	3.	ACTROS, AXOR, ATEGO, MK, NG	26	145	80000C	942 420 02 38	KOCN1478

MERCEDES							
Slika	Poz.	Tip vozila	Broj zuba	Osnovno rastojanje (mm)	Haldex broj	OE broj	RAPIDEX broj
	4.	ACTROS, AXOR, ATEGO, MK, NG	26	145	80001C	942 420 03 38	KOCN1411
	5.	MK, NG, LK	26	145	80010C	945 420 08 38	KOCN1479
	6.	MK, NG, LK	26	145	80011C	945 420 07 38	KOCN1480
	7.	MK, NG, LK	26	145	70954C	617 420 02 38	KOCN1481
	8.	ACTROS, ACTROS II, AXOR	26	145	80014C	945 420 04 38	KOCN0331
	9.	MK, NG, SK	26	145	104407401	346 420 17 38	KOCN0821

MERCEDES							
Slika	Poz.	Tip vozila	Broj zuba	Oso rastojanje (mm)	Haldex broj	OE broj	RAPIDEX broj
	10.	NG	14	145	-	000 420 04 38	KOCN1482
	11.	MK, NG, SK	26	145	104507401	346 420 18 38	KOCN0831

RENAULT							
Slika	Poz.	Tip vozila	Broj zuba	Oso rastojanje (mm)	Haldex broj	OE broj	RAPIDEX broj
	1.	AE3809-AE520	27	145	79015C	5000789894	KOCN1483
	2.	PREMIUM, MIDLUM	28	145	79305C	5010260028	KOCN1484
	3.	MIDLUM	28	145	79304C	5010260027	KOCN0117

SCANIA							
Slika	Poz.	Tip vozila	Broj zuba	Oso rastojanje (mm)	Haldex broj	OE broj	RAPIDEX broj
	1.	SERIJA 4 94, 114, 124	10	145	72661C	1 112 834	KOCN1485
	2.	SERIJA 4 94, 114, 124	10	145	72660C	1 112 833	KOCN1486
	3.	SERIJA 4 94, 114, 124	10	145	72662C	1 112 831	KOCN1487
	4.	SERIJA 3	10	145	72663C	1 112 829	KOCN1488
	5.	SERIJA 3	10	145	72664C	1 112 830	KOCN1489
	6.	SERIJA 4 94, 114, 124, 144	10	145	79442C	1 358 634	KOCN0185

SCANIA							
Slika	Poz.	Tip vozila	Broj zuba	Oso rastojanje (mm)	Haldex broj	OE broj	RAPIDEX broj
	7.	SERIJA 4 94, 114, 124, 144	10	145	79443C	1 358 635	OSOV0074
	8.	SERIJA 3	10	145	72665C	1 112 836	KOCN1490

VOLVO							
Slika	Poz.	Tip vozila	Broj zuba	Oso rastojanje (mm)	Haldex broj	OE broj	RAPIDEX broj
	1.	B7, 10, 12	10	145	72785C	1197966	KOCN1491
	2.	B7, 10, 12	10	145	72678C	1196321	KOCN1492
	3.	B7, 10, 12	10	145	72783C	1195462	KOCN0238
	4.	B7, 10, 12	10	145	72678C	1501311	KOCN1493

BPW							
Slika	Poz.	Tip vozila	Broj zuba	Oso rastojanje (mm)	Haldex broj	OE broj	RAPIDEX broj
	1.	EH EHS, H HZMD	10	250, 140	100001760	05.174.65.13.0	KOCN0812
	2.	H HZVB, H HZM	10	250, 140	100001721	05.174.32.61.0	KOCN0829
	3.	EH EHF, EH EHI	10	250, 140	80019D	05.574.82.87.3	KOCN0942
	4.	H HZMD, HHZM	10	250, 140	100001721	05.174.52.61.0	KOCN0829
	5.	HHSFLL, H HSM	10	250, 140	72876C	05.174.82.31.2	KOCN0120

4

4

SAF							
Slika	Poz.	Tip vozila	Broj zuba	Oсно растојanje (mm)	Haldex broj	OE broj	RAPIDEX broj
	1.	SKRB	10	250, 140	79005D	3.434.3502.0	KOCN0942
	2.	SKRB	10	250, 140	79006C	4.175.0247.00	KOCN1494
	3.	SKRB	10	250, 140	100101047	2.175.0294.00	KOCN0640
	4.	SKRB	10	250, 140	100101743	2.175.0037.00	KOCN0813
	5.	SKRB	10	250, 140	72876C	4.175.0184.00	KOCN0120

SET ZA POPRAVKU ŠTELERA				
Slika	Poz.	Haldex broj	OE broj	RAPIDEX broj
	1.	76046		KOCN0235
	2.	76980		KOCN1327







S KLJUČEVI

Poz.	Tip vozila	OE broj	RAPIDEX broj
1.	DAF FT95	393771	OSO0384
2.	DAF FT95	392769	OSO0385
3.	MAN F90	81.50301.0223	OSO0386
4.	MAN EL, LION'S STAR, SL	81.50301.0225	OSO0387
5.	MAN EM, LION'S STAR, SL	81.50301.0226	OSO0388
6.	MAN F90, F2000, M90, NG, NL	81.50301.0112	OSO0389
7.	MAN F7/8/9, M/F90, M/F2000	81.50301.0224	OSO0390
8.	MAN F7/8/9, L/M/F2000	81.50301.0113	OSO0391
9.	MERCEDES SK/MK/NG	623 421 01 36	KOCN0896
10.	MERCEDES SK/MK/NG	623 421 02 36	KOCN0895
11.	SCANIA 94/114/124/144	1 340 859	OSO0392
12.	SCANIA 94/114/124/144	1 340 860	OSO0393
13.	SCANIA 94/114/124	1 342 746	OSO0394
14.	SCANIA 94/114/124	1 342 745	OSO0395
15.	BPW	05.097.0529.4	OSO0400
16.	BPW	05.097.0530.4	OSO0401
17.	BPW	05.097.6006.4	OSO0035
18.	BPW	05.097.60.05.4	OSO0036
19.	FRUEHAUF	A-JA-0476-003	OSO0402
20.	FRUEHAUF	A-JA-0476-004	OSO0403
21.	KÄSSBOHRER	010.24.21.849.59	OSO0404
22.	KÄSSBOHRER	010.24.21.849.77	OSO0405
23.	ROR	212 19 257	OSO0406
24.	ROR	212 19 258	OSO0407
25.	ROR	212 21 194	OSO0408
26.	ROR	212 21 195	OSO0409
27.	TRAILOR	6503390L	OSO0410
28.	TRAILOR	6503391M	OSO0411

ČAURE S KLJUČA

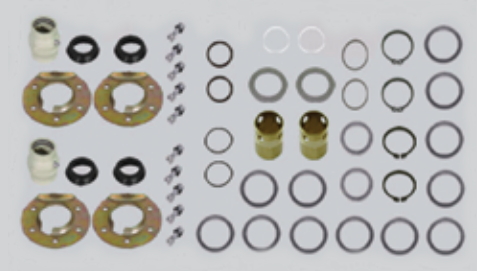
Slika	Poz.	Tip vozila	Dimenzije	OE broj	RAPIDEX broj
	1.	MAN	30 x 35 x 45	81.93020.0013	OSO0299
	2.	MAN	42 x 34 x 30	81.93020.0576	KOCN0769
	3.	MERCEDES	42 x 34 x 30	307 421 05 50	KOCN0769
	4.	SCANIA	38 x 42 x 26	289336	OSO0297
	5.	SCANIA	45 x 50 x 16	1302857	OSO0296
	6.	BPW	42 x 46 x 70,5	03.112.44.30.0	OSO0294
	7.	BPW	42 x 46 x 72,6	03.112.44.34.0	OSO0062
	8.	SAF	40 x 46 x 50	4.230.0180.00	OSO0295
	9.	SAF	60 x 56 x 333	4.230.0176.00	OSO0462

ČAURE S KLJUČA					
Slika	Poz.	Tip vozila	Dimenzije	OE broj	RAPIDEX broj
	10.	BPW	SET	09.801.02.13.0	OSOV0206
	11.	BPW	SET	09.801.02.15.0	OSOV0479
	12.	BPW	SET	09.801.06.09.1	KOCN0002
	13.	BPW	SET	09.801.00.14.1	OSOV0200
	14.	SAF	SET	3.434.3639.00	OPRE0109

ČAURE S KLJUČA					
Slika	Poz.	Tip vozila	Dimenzije	OE broj	RAPIDEX broj
	15.	SAF	SET	3.434.3638.00	OSOV0003
	16.	SAF	SET	3.434.3636.00	OSOV0002
	17.	SAF	SET	3.268.0034.00	OSOV01007
	18.	SAF	SET	3.434.3601.00	OSOV0463
	19.	SAF	SET	1.230.2001.01	OSOV0197

ČAURE S KLJUČA

Slika	Poz.	Tip vozila	Dimenzije	OE broj	RAPIDEX broj
	20.	SAF	SET	1.230.1002.04	OSOV0298
	21.	TRAILOR	SET	6503723T	OSOV0464
	22.	TRAILOR	SET	6502103X	OSOV0465



OPRUGE KOČNICA

Poz.	Tip vozila	Dimenzije (mm)	OE broj	RAPIDEX broj
1.	DAF F65/95, 65CF, BUS F3300/3600		1279502	OSOV0466
2.	DAF F85/95, F3600, F2800/3200		1340297	OSOV0467
3.	DAF BUS, F95, F3300, 2900		191530	OSOV0468
4.	MAN M/F90, M/F2000, TGA	240 mm	81.97610.0271	OSOV0469
5.	MAN M/F90, F2000, TGA, TGS, TGX	240 mm	81.97610.0115	OSOV0470
6.	MERCEDES ACTROS, ACTROS MP2, ATEGO, ATEGO 2, AXOR, MK, SK, NG	245 mm	617 993 11 10	KOCN0374
7.	MERCEDES ACTROS, ACTROS MP2, ATEGO, ATEGO 2, AXOR, MK, SK, NG	232 mm	945 993 00 10	OSOV0471
8.	MERCEDES ACTROS, ACTROS MP2, ATEGO, AXOR, MK, NG, SK	228 mm	346 993 08 10	OSOV0472
9.	SCANIA SERIJA 3, 4, P, G, R, T		1 309 465	OSOV0473
10.	VOLVO FL, FM, FH	215 mm	1695051	OSOV0474
11.	VOLVO FL, FM, FH	202 mm	346499	OSOV0475
12.	VOLVO FL, FM, FH	200 mm	1586683	OSOV0476
13.	BPW R RB5508, EH EHF, M MIF		05.397.58.03.0	OSOV0007
14.	BPW R RBF, EH EHIZVB	147 mm	03.397.2603.0	OSOV0215
15.	BPW M MB, M MSF	125 mm	03.397.3306.0	OSOV0013
16.	BPW H HBFH, R RIOTA	120 mm	03.397.3307.0	OSOV0014
17.	SAF SKRB, RBM RBM			KOCN0584
18.	SAF WRLZM, SKRLZ, RBM RBM	232 mm	1.147.0058.01	OSOV0015

GLAVČINE TOČKA

Poz.	Tip vozila	OE broj	RAPIDEX broj
1.	DAF F75, 85, 95, CF75, 85, 95XF, BUS	1348432	OSOVO266
2.	DAF CF85	1391615	OSOVO267
3.	DAF F95	0224363 1245169	OSOVO268
4.	DAF FT95	0538444 1355063	OSOVO269
5.	MAN TGL	81.35701.0165	KOCN0051
6.	MAN TGL KOMPLET	81.93420.0337	KOCN0319
7.	MERCEDES ATEGO	972 330 03 25	OSOVO412
8.	MERCEDES ACTROS	000 350 05 35	OSOVO033
9.	MERCEDES ACTROS, AXOR	385 356 14 01	OSOVO048
10.	MERCEDES ACTROS, AXOR, MK, SK	942 334 12 01	OSOVO277
11.	MERCEDES ATEGO	972 356 02 01	VESA0020

GLAVČINE TOČKA

Poz.	Tip vozila	OE broj	RAPIDEX broj
12.	SCANIA SERIJA 4 P/G/R/T	1 414 154	OSOVO270
13.	SCANIA SERIJA 4 P/G/R/T	1 480 933	OSOVO271
14.	SCANIA SERIJA 4 P/G/R/T	1 382 884	OSOVO272
15.	SCANIA P, T, R, G,	1 800 283	OSOVO273
16.	VOLVO FH12, FH16	1626992	OSOVO274
17.	VOLVO FH12, FH16, FM9, FM10, FM12	20517952	OSOVO275
18.	VOLVO FH12, FH16, FM9, FM10, FM12	20517164	OSOVO276
19.	BPW	03.272.43.14.1	OSOVO004
20.	BPW 9210	03.272.30.41.0	OSOVO019
21.	ROR-TM KOMPLET	14224262	OSOVO413
22.	SAF	1.146.2004.02	OSOVO278
23.	SAF SK 500 KOMPLET	3.307.1159.00	OSOVO170
24.	SAF SK 500 PLUS KOMPLET	3.307.1166.00	OSOVO169
25.	SAF SKRS 9042 NOVI TIP	3.307.3006.00	OSOVO414
26.	SAF SK90 19K KOMPLET	3.307.3025.01	OSOVO168
27.	SAF SKRB9019KI, INTEGRAL	3.307.3030.01	KOCN0599
28.	SAF HUB UNIT SA LEŽAJEVIMA	3.307.3012.00	OSOVO128
29.	TRAILOR	6502795C	OSOVO279
30.	TRAILOR	M006050	OSOVO280
31.	FRUEHAUF	A-JB0038-001	OSOVO348

LEŽAJEVI

Poz.	Tip vozila	Dimenzije (mm)			KBP	OE broj	RAPIDEX broj
1.	DAF 75/85/95, FC75/85, 95XF	160	105	43	33021	266488	OSOVO415
2.	DAF F2800, 2900, F75/95, CF75, BUS	100	45	38,25	32309	283686	OSOVO416
3.	DAF CF 75, 85, 95XF	140	80	46	33216	556290	OSOVO417
4.	DAF F1600, F2100, F2300	130	70	58	528983B	260204	OSOVO418
5.	DAF CF 65, 75, 85, 95FA, 95XF	110	50	42,25	32310A	626875	OSOVO219
6.	DAF CF75/85, XF95	120	55	45,5	32311A	272828	OSOVO420
7.	IVECO DAILY				30305	26800330	OSOVO421
8.	IVECO DAILY				32208	26800140	OSOVO422
9.	IVECO EUROSTAR, EUROTECH	180	100	49	32220A	1905351	OSOVO217
10.	IVECO EUROSTAR, EUROTECH, STRALIS				201059	1905487	OSOVO149
11.	IVECO EUROSTAR, EUROTECH, STRALIS				VKBA5397	1905487	OSOVO149

LEŽAJEVI

Poz.	Tip vozila	Dimenzije (mm)			KBP	OE broj	RAPIDEX broj
12.	MAN G90, L2000	100	55	40	201009	06.32489.0072	OSOVO098
13.	MAN M90, L2000	125	75	37	33115	06.32499.0040	OSTA0033
14.	MAN L2000, M2000	72	35	24,23	32207A	06.32499.0079	OSOVO109
15.	MAN F90, F2000	110	50	42,25	32310	06.32499.0016	OSOVO219
16.	MAN F90, F2000	170	110	47	33022	06.32499.0155	OSOVO423
17.	MAN F90, F2000	160	106	35	528595	06.32489.0009	OSOVO424
18.	MAN TGL, TGM				VKBA5412	81.93410.0344	OSOVO095
19.	MAN TGA				803750B	81.93420.0342	OSOVO091
20.	MAN TGA, TGS, TGX				VKHB5377	81.93420.0288	OSOVO093
21.	MAN TGA, TGM					81.93420.0379	OSOVO072
22.	MERCEDES ACTROS, ATEGO 2, MK, NG	150	70	54	32314	004 981 99 05	OSOVO425
23.	MERCEDES ACTROS, ACTROS MP2, ATEGO, AXOR	130	80	37	33116	012 981 40 05	OSOVO046
24.	MERCEDES ACTROS, ATEGO, AXOR 2	130	60	48,5	32312	011 981 68 05	OSOVO426
25.	MERCEDES ACTROS, ATEGO, AXOR 2, MK, NG	160	105	43	33021	005 981 49 05	OSOVO415
26.	MERCEDES ACTROS, ATEGO, MK, NG	110	50	42,25	32310	001 981 76 05	OSOVO219
27.	MERCEDES ACTROS, AXOR 2, ATEGO	157	110	43,5	VKHB2329	009 981 43 05	OSOVO427
28.	MERCEDES ACTROS, AXOR 2, ATEGO	150	100	32	32020X	006 981 04 05	OSOVO428
29.	MERCEDES ACTROS, AXOR, ATEGO	150	70	64	201069	013 981 42 05	OSOVO429
30.	MERCEDES ACTROS, AXOR, ATEGO	120	55	45,5	32311	006 981 08 05	OSOVO196
31.	MERCEDES ACTROS, AXOR 2, ATEGO, MK, NG, SK	180	110	63	33220	003 981 45 05	OSOVO431
32.	MERCEDES ATEGO 2, MK, NG, LK/LN				33208	003 981 39 05	OSOVO432
33.	MERCEDES ATEGO, ATEGO 2, SK, NG, MK	120	65	41	33213	003 981 37 05	OSOVO179

LEŽAJEVI							
Poz.	Tip vozila	Dimenzije (mm)			KBP	OE broj	RAPIDEX broj
34.	MERCEDES ATEGO, NG, LK				32306A	001 981 83 05	OSOVO234
35.	MERCEDES LK/LN2				33111	000 980 75 02	OSOVO433
36.	MERCEDES SPRINTER	73,43	41,27	20	VKHB2153	608 981 00 05	OSOVO097
37.	SCANIA SERIJA 2, 3	147	90	41,7	VKHB2029	1 524 625	OSOVO099
38.	SCANIA SERIJA 2, 3, 4	130	75	41	33215	260998	OSOVO106
39.	SCANIA SERIJA 3, 4, P, R, T	127	68	115	VKBA5314	1 413 785	OSOVO094
40.	SCANIA SERIJA 4	147	90	40	KHM218248	291060	OSOVO107
41.	SCANIA SERIJA 4	127	117	68	201037	1 439 070 S1	OSOVO006
42.	SCANIA SERIJA 4	130	70	43	VKHB2024	322748	OSOVO092
43.	VOLVO FM 7/9/10, FH12				VKHB2053		OSOVO115
44.	VOLVO F10, 12, 16, FH12,16, FL7, 10, 122	130	70	43	VKHB2024	8151816	OSOVO092
45.	VOLVO F10, 12, 16, FH12, 16, FM 9, 7	130	850	29	VKHB2169	184623	OSOVO434
46.	VOLVO B10, 12, F12,16, F7, 10				VKT8629	1523666	OSOVO435
47.	VOLVO FM 10, 7, FL10, FH12				30314	1656100	OSOVO436
48.	BPW SH ECO	110	50	42,25	32310A	02.6410.25.00	OSOVO101
49.	BPW ECO, ECO MAX	130	80	38	33116	02.6410.24.00	OSOVO103
50.	BPW ECO, ECO PLUS	150	90	45	33118	02.6410.23.00	OSOVO104
51.	BPW H HSM, H HSOM, H HSH	120	65	41	33213	02.6410.29.01	OSOVO105
52.	BPW NR NRZM, NR NRLL	130	75	41	33215	02.6407.75.00	OSOVO106
53.	BPW R RBM, NR NRS				VKBA5527	09.801.02.24.00	OSOVO096
54.	BPW ECO, 6, 5-9 T				VKBA5521	09.801.02.33.0	OSOVO160
55.	SAF RSM, RZM	132	76	41	KHM215249	4.200.1007.00	OSOVO437

LEŽAJEVI							
Poz.	Tip vozila	Dimenzije (mm)			KBP	OE broj	RAPIDEX broj
56.	SAF SK9042		SET			3.434.3012.00	OSOVO181
57.	SAF SK500/500PLUS		SET			3.434.3016.00	OSOVO162
58.	SAF RSM, RZM	147	90	40	KHM218248	4.200.1010.00	OSOVO041
59.	SAF WRLZM8130, RSM	120	65	41	33213	4.200.0060.00	OSOVO179
60.	SAF RSM, RZM				32218A	4.200.0027.00	OSOVO108
61.	SAF RSM, RLSM	165	120	29	32924	4.200.1010.00	OSOVO102
62.	SAF RSM, RLMB, RZM	147	90	40	VKHB2407S	4.200.1006.00	OSOVO107
63.	ROR TM&DX195	120	65	41	VKHB2405S	99041045S	OSOVO105
64.	ROR LM&LC	140	82	37,53	VKBA5553	99041075	OSOVO023



SEMERINZI

Poz.	Tip vozila	Dimenzije (mm)			OE broj	RAPIDEX broj
1.	DAF F65/75/85/95, CF75/85, 95XF	100	140	15/20,5	1238034	OSOV0439
2.	DAF CF65/75IV, 85IV, XF95, XF105	125	160/190	18/20	1335063	OSOV0440
3.	DAF F65/75/85, 95, CF65/75/85, 95XF, 95XF	100	140/166	16/22	1334961	OSOV0441
4.	DAF F65/75/85/95, CF65, 75, 85, 95XF, XF95	100	140	15,5/20	1278420	OSOV0442
5.	DAF F1900, F95	90	140	15,5/20	1278421	OSOV0443
6.	IVECO EURO TRAKKER, EUROTECH, EUROSTAR	140	165	13	098467213	OSOV0444
7.	IVECO EUROCARGO	114	153	13	099457401	OSOV0445
8.	IVECO EUROCARGO, TURBODAYLI	95	130	16	040102143	OSOV0446
9.	IVECO EUROCARGO, EUROSTAR, EUROTECH	179	200	15,7	040102941	OSOV0447

SEMERINZI

Poz.	Tip vozila	Dimenzije (mm)			OE broj	RAPIDEX broj
10.	IVECO EUROSTAR, EUROTECH	180	200	12	040100443	OSOV0448
11.	IVECO EUROCARGO, EUROCARGO, TEKKTOR	65	90	13/14,5	040102293	OSOV0449
12.	MAN F7/8/9, F90, F2000, TGA	145	175	14	06.56289.0335	OSOV0450
13.	MAN M/F90, L/M/F2000, TGA, TGS, TGX	80	135	15,4	06.56289.0293	OSOV0451
14.	MAN F2000	145	175	18	81.96503.0398	OSOV0452
15.	MAN F90, M90, F2000, M2000	145	175	17	06.56289.0386	OSTA0296
16.	MAN L/M2000, TGA, TGM, TGX, TGS.	132	172	12	81.96503.0333	OSOV0453
17.	MAN G90, F90, L2000, TGA	145	175/205	9/14	06.56289.0371	OSOV0454
18.	MERCEDES ACTROS, NK, SK	85	145	12/37	015 997 47 47	OSOV0455
19.	MERCEDES ACTROS, ACTROS MP2, ATEGO, AXOR	145	175	17/21	020 997 39 47	OSTA0237
20.	MERCEDES ACTROS, ACTROS MP2, AXOR, ATEGO, ECONIC	145	175	13	013 997 94 47	OSTA0307
21.	MERCEDES ACTROS, NG, SK	145	175	14	016 997 56 47	OSTA0300
22.	MERCEDES ACTROS, ACTROS MP2, AXOR, AXOR 2, SK, NG		SET		624 356 00 80	MENJ0245
23.	MERCEDES ACTROS, ATEGO, ECONIC, ACTROS MP2		SET		940 350 00 35	MENJ0249
24.	MERCEDES ACTROS, AXOR 2, ECONIC. TRAVEGO, AXOR	153	195,5	17	942 356 03 15	OSOV0174
25.	MERCEDES ACTROS, ATEGO, SK, MK	150	125	15	385 350 00 68	OSOV0175

SEMERINZI						
Poz.	Tip vozila	Dimenzije (mm)			OE broj	RAPIDEX broj
26.	MERCEDES ACTROS, ATEGO, MK, NG, SK, O 303	205/175	145	18/20	020 997 05 47	OSOVO207
27.	MERCEDES ACTROS MP2, AXOR 2, TOURISMO O403		SET		942 350 39 35	OSOVO195
28.	SCANIA SERIJA 3	125	160	15	375086	OSOVO318
29.	SCANIA SERIJA 3, 4, P, G, R, T	75	100	14	1 409 890	OSOVO319
30.	SCANIA SERIJA 3	137	162	15/12	370074	OSOVO456
31.	SCANIA SERIJA 4, 94, 114, 124, 144, 164, P, G, R, T	85	105	12/18	1 502 385	OSOVO316
32.	SCANIA SERIJA 4, 94, 114, 124, 144, 164, P, G, R, T	142	170	15/16	1 534 012	OSOVO317
33.	VOLVO FM9, 10, 12, FH12, 13, 16	52	38	7	958861	OSOVO457
34.	VOLVO F10, 12, 16, FH12, 16, FL10, 12, N10	164	140	20/23,5	1522372	OSOVO458
35.	VOLVO FM9, 10, 12, FH12, 13, 16	90	145	10/16	1673701	OSOVO459
36.	VOLVO FM9, F12, FH12	85	130	22	3152027	OSOVO460
37.	VOLVO FM9, 10, 12, FH12, 16	90	111	6/8	1652622	OSOVO461
38.	SAF SK 9037		SET		3.434.3013.00	OPRE0102
39.	SAF 403	117,47	125,4	25,4	4.373.0035.01	OSOVO178
40.	SAF SK 500, SK-500 PLUS	PRSTEN ABS			4.029.1001.01	OSOVO167
41.	KLIZAČ SEMERINGA	118	135/145	24	81.35710.0067	KOCN0478



DAF							
Poz.	Naziv	Dimenzije (mm)			Navoj (mm)	OE broj	RAPIDEX broj
1.	VIJAK	104	42	25,3	M22 x 1,5	0620647	OSOVO330
	NAVRTKA	30	OK32		M22 x 1,5	0652575	OSOVO334
2.	VIJAK	85	43	19	M22 x 1,5	0620646	OSOVO335
	NAVRTKA	30	OK32		M22 x 1,5	0652575	OSOVO334
3.	VIJAK	120	39	25	M22 x 1,5	0191175	OSOVO336
	NAVRTKA	18	OK32		M22 x 1,5	0 91649	OSOVO337
	NAVRTKA	22	OK32		M22 x 1,5	0 44922	OSOVO338

IVECO							
Poz.	Naziv	Dimenzije (mm)			Navoj (mm)	OE broj	RAPIDEX broj
4.	VIJAK	75	32		M18 x 1,5	07168333	OSOVO339
	NAVRTKA	27	OK27		M18 x 1,5	21190	OSOVO340
5.	VIJAK	110	38		M22 x 1,5	42117455	OSOVO341
	NAVRTKA	28	OK30		M22 x 1,5	41800483	OSOVO342

MAN

Poz.	Naziv	Dimenzije (mm)			Navoj (mm)	OE broj	RAPIDEX broj
6.	VIJAK	77	38		M22 x 1,5	81.45501.0076	OSOV0343
	NAVRTKA	28	OK30		M22 x 1,5	06.11222.0218	OSOV0344
7.	VIJAK	95	38		M22 x 1,5	81.45501.0080	OSOV0345
	NAVRTKA	23	OK30		M22 x 1,5	06.11222.0218	OSOV0343
8.	VIJAK	105	38		M22 x 1,5	81.45501.0081	OSOV0346
	NAVRTKA	23	OK30		M22 x 1,5	06.11222.0218	OSOV0343

MERCEDES

Poz.	Naziv	Dimenzije (mm)			Navoj (mm)	OE broj	RAPIDEX broj
9.	VIJAK	89	38		M22 x 1,5	381 401 05 71	OSOV0347
	NAVRTKA	23	OK30		M22 x 1,5	620 400 00 24	OSOV0348
10.	VIJAK	105	38		M22 x 1,5	381 401 06 81	OSOV0349
	NAVRTKA	23	OK30		M22 x 1,5	620 400 00 24	OSOV0348
11.	VIJAK	115	38		M22 x 1,5	381 401 08 71	OSOV0350
	NAVRTKA	23	OK30			620 400 00 24	OSOV0348
12.	VIJAK	89	43		M20 x 1,5	305 401 00 71	OSOV0351
	NAVRTKA	22	OK27			620 400 00 24	OSOV0348

SCANIA

Poz.	Naziv	Dimenzije (mm)			Navoj (mm)	OE broj	RAPIDEX broj
13.	VIJAK	96	72		7/8-11 BSF	272853	OSOV0360
	NAVRTKA	31	OK32		7/8-11 BSF	318690	OSOV0361
14.	VIJAK	90	64		7/8-11BSF	123294	OSOV0362
	NAVRTKA	31	OK32		7/8-11 BSF	318690	OSOV0363
15.	VIJAK	92	69		7/8-11BSF	121302	OSOV0364
	NAVRTKA	16	OK32		7/8-11BSF	121305	OSOV0365
	NAVRTKA	27	OK32		7/8-11 BSF	120913	OSOV0366

VOLVO

Poz.	Naziv	Dimenzije (mm)			Navoj (mm)	OE broj	RAPIDEX broj
16.	VIJAK	96	36		7/8-14BSF	6852474	OSOV0367
	NAVRTKA	35	OK32		7/8-14SAE	0943491	OSOV0368
17.	VIJAK	110	39		7/8-14BSF	1589009	OSOV0369
	NAVRTKA	35	OK32		7/8-14SAE	0943491	OSOV0368
18.	VIJAK	130	35	40	7/8-14SAE	0943406	OSOV0370
	NAVRTKA	22	OK32		7/8-14SAE	0943402	OSOV0371
	NAVRTKA	35	OK32		7/8-14SAE	0943491	OSOV0368

BPW

Poz.	Naziv	Dimenzije (mm)			Navoj (mm)	OE broj	RAPIDEX broj
19.	VIJAK	100	38	26	M22 x 1,5	03.296.2315.0	OSOV0320
	NAVRTKA	17	OK32		M22 x 1,5	03.260.0406.0	OSOV0321
	NAVRTKA	30	OK32		M22 x 1,5	02.521.9213.0	OSOV0322
20.	VIJAK	114	50	26	M22 x 1,5	03.296.2317.0	OSOV0325
	NAVRTKA	17	OK32		M22 x 1,5	03.260.0406.0	OSOV0326
	NAVRTKA	30	OK32		M22 x 1,5	02.521.9213.0	OSOV0327
21.	VIJAK	90	46	20	M22 x 1,5	03.296.3311.1	OSOV0328
	NAVRTKA	30	OK32		M22 x 1,5	2120399	OSOV0329

SAF

Poz.	Naziv	Dimenzije (mm)			Navoj (mm)	OE broj	RAPIDEX broj
22.	VIJAK	93	53		M22 x 1,5	1.303.1075.11	OSOV0352
	NAVRTKA	30	OK32		M22 x 1,5	4.247.3012.00	OSOV0353
23.	VIJAK	112	50	24	M22 x 1,5	1.303.1040.11	OSOV0354
	NAVRTKA	17	OK32		M22 x 1,5	4.342.0017.10	OSOV0355
	NAVRTKA	30	OK32		M22 x 1,5	4.247.3012.00	OSOV0356
24.	VIJAK	110	46	28	M22 x 1,5	1.303.1013.10	OSOV0357
	NAVRTKA	16	OK30		M22 x 1,5	4.342.0008.10	OSOV0358
	NAVRTKA	25	OK32		M22 x 1,5	4.342.0015.10	OSOV0359

5.0 ELEMENTI OGIBLJENJA I UPRAVLJANJA

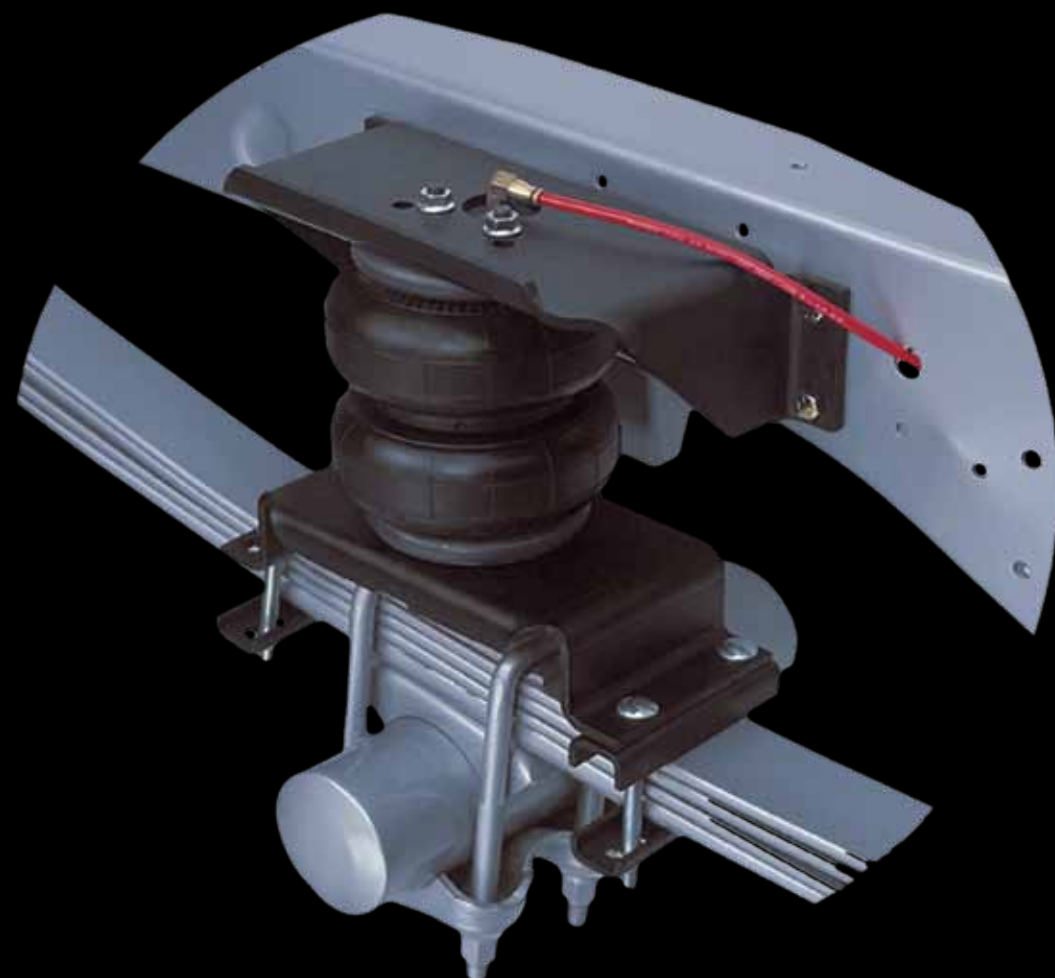

5.0 ELEMENTI OGIBLJENJA I UPRAVLJANJA

5.1	Amortizeri	280
5.2	Vazdušni jastuci	302
5.3	Gibnjevi	338
5.4	Delovi stabilizatora	366
5.5	Delovi rukavca	379
5.6	Spone i delovi spona	386
5.7	Uporne spone	404
5.8	V spone	407

[NAZAD NA GLAVNI SADRŽAJ](#)

AMORTIZERI - TIPOVI VEZA

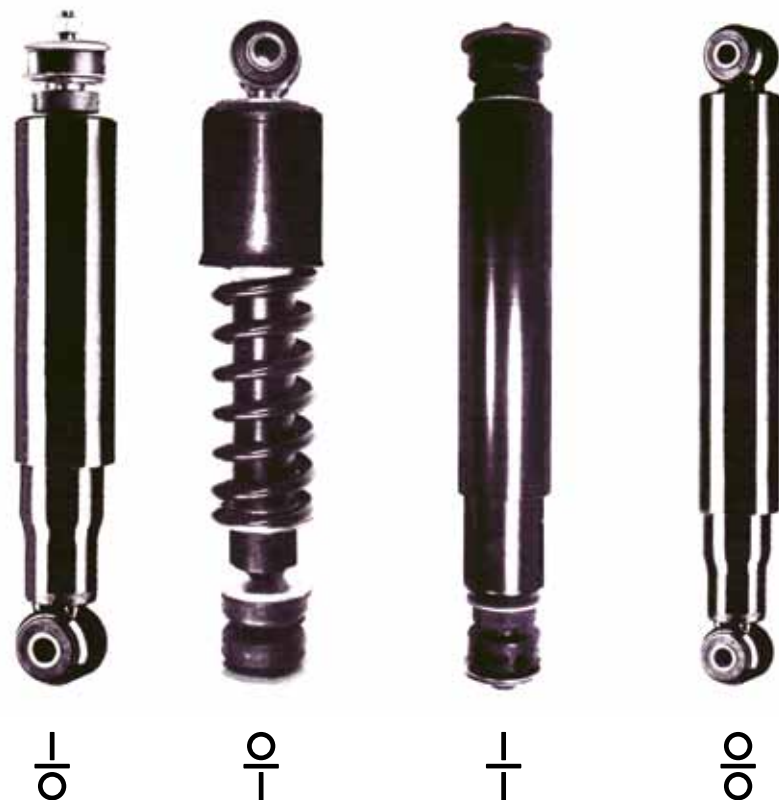

LEGENDA:

SIMBOL	ZNAČENJE	SIMBOL	ZNAČENJE
	VEZA OKO - OKO		AMORTIZER PREDNJE OSOVINE
	VEZA OKO - VIJAK		AMORTIZER ZADNJE OSOVINE
	VEZA VIJAK - OKO		PREDNJA I ZADNJA OSOVINA
	VEZA VIJAK - VIJAK		AMORTIZER KABINE - PREDNJI
	VEZA OKO - VILJUŠKA		AMORTIZER KABINE - ZADNJI
	AMORTIZER VOLANA		AMORTIZER KABINE



DAF						
Poz.	Tip vozila	Osovina	Tip veze	OE broj	Sachs broj	RAPIDEX broj
1.	LF45			AFRE002	300 026	AMOR0272
2.	LF45			AFRE008	311 500	AMOR0273
3.	LF45			1 407 073	310 616	AMOR0274
4.	LF45			AFRE007	311 496	AMOR0275
5.	LF55			AFRE003	311 498	AMOR0276
6.	LF55, 65, 65CF, CF65, 75, 75CF, CF75, 85, 85CF, CF85, 95, 95XF, XF95			1443695	290 981	AMOR0277
7.	LF55			AFRE010	311 502	AMOR0278
8.	65, 75, 85, 95			086576	112 277	AMOR0279
9.	65CF, 75, 75CF, 85, 85CF, 95, 95XF			1282623	124 874	AMOR0280
10.	65CF, 75CF, CF75, 85CF, CF85, 95, 95XF			1283732	112 002	AMOR0281
11.	CF75, CF85			1450885	290 982	AMOR0282
12.	CF75, CF85, 95			379131	106 977	AMOR0283
13.	CF75, 85CF, CF85			1427903	290 979	AMOR0284
14.	CF75, 85CF, CF85, XF95			1382704	290 983	AMOR0285
15.	CF85			092968	131 158	AMOR0286

DAF

Poz.	Tip vozila	Osovina	Tip veze	OE broj	Sachs broj	RAPIDEX broj
16.	95, 95XF			1283723	106 976	AMOR0287
17.	95			740021	112 145	AMOR0288
18.	95XF, XF95, XF105			1398694	290 980	AMOR0041
19.	XF105			1649947	-	AMOR0040
20.	Neoplan N113, 116, 121, 210, 214, 418			1002.103.00	101 424	AMOR0253
21.	Neoplan N113, 116, 121, 210, 214, 418			1002.102.00	101 425	AMOR0200

IVECO

Poz.	Tip vozila	Osovina	Tip veze	OE broj	Sachs broj	RAPIDEX broj
1.	Euro Cargo 60E, 65E, 75E			98426865	123 937	AMOR0289
2.	Euro Cargo 60E, 65E, 75E, 80E, 100E			98415100	112 498	AMOR0290
3.	Euro Cargo 80E, 100E			98411160	112 554	AMOR0291
4.	Euro Cargo 100E			504052219	311 492	AMOR0292
5.	Euro Cargo 120E, 130E			98447153	125 935	AMOR0293
6.	Euro Cargo 120E, 130E, 150E			98408706	125 938	AMOR0294
7.	Euro Cargo 120E, 130E			98408707	125 937	AMOR0295

IVECO

Poz.	Tip vozila	Osovina	Tip veze	OE broj	Sachs broj	RAPIDEX broj
8.	Euro Cargo 130E, 150E, 170E			98415098	125 936	AMOR0296
9.	Euro Cargo 130E, 150E, 170			98436446	125 941	AMOR0297
10.	Euro Cargo 150E			98443387	125 932	AMOR0298
11.	Euro Cargo 150E, 170E, 180E			98488520	125 942	AMOR0299
12.	Euro Cargo 170E, 180E			99431723	280 923	AMOR0300
13.	Euro Star 190E, 240E, 260E, 440E, Euro Star Cursor 260E, Euro Tech MP, Stralis			41214818	131 621	AMOR0007
14.	Euro Star, Cursor, Euro Tech, Euro Trakker, Stralis			41214700	131 377	AMOR0014
15.	Euro Trakker, 190E Cursor			98414526	125 933	AMOR0301
16.	Euro Trakker, 190E Cursor, 260E Cursor			98498740	125 889	AMOR0302
17.	Stralis AS 260			41033239	131 948	AMOR0303
18.	Stralis AS440S35, AS440S48			41225418	310 049	AMOR0008



MAN

Poz.	Tip vozila	Osovina	Tip veze	OE broj	Sachs broj	RAPIDEX broj
1.	F90, F2000, M90, M2000L			81.43701.6598	112 859	AMOR0105
2.	F2000, M2000L, M2000M			81.43701.6793	125 148	AMOR0106
3.	F90, F2000, M2000L			81.43701.6711	125 149	AMOR0094
4.	F90, F2000			81.43701.6633	123 863	AMOR0304
5.	F90, F2000, 19..., 22, 24, 25, 26			81.43701.6564	112 853	AMOR0305
6.	F90, F2000, M90, TGA, 22..., 24, 25, 26			81.43701.6568	112 854	AMOR0245
7.	F90, 16..., 17, 19, 20, 22, 24, 25, 26, 32, 40, 48			81.43701.6456	112 869	AMOR0306
8.	F90			81.43701.6751	112 929	AMOR0307
9.	F90, F2000, 19362FL			81.43701.6634	123 864	AMOR0308
10.	L2000, M2000L			81.43701.6789	125 512	AMOR0309
11.	L2000			81.43701.6782	124 610	VESA0088
12.	F2000			81.43701.6794	125 857	AMOR0310
13.	F2000			81.43701.6017	125 858	AMOR0311
14.	F90, TGA			81.43701.6721	131 146	AMOR0312
15.	TGA			81.43701.6902	131 750	AMOR0230
16.	TGA			81.43701.6904	280 928	AMOR0313

MAN

Poz.	Tip vozila	Osovina	Tip veze	OE broj	Sachs broj	RAPIDEX broj
17.	TGA			81.43701.6964	280 930	AMOR0104
18.	TGA			81.43701.6911	280 931	AMOR0314
19.	TGA			81.43701.6897	280 935	AMOR0315
20.	F2000, TGA			81.43701.6868	280 937	AMOR0316
21.	TGA			81.43701.6926	280 938	AMOR0317
22.	F2000, TGA			81.43701.6934	300 001	AMOR0318
23.	TGA			81.43701.6973	300 002	AMOR0319
24.	TGA			81.43702.6037	310 626	AMOR0320
25.	TGA			81.43701.6949	310 628	AMOR0321
26.	TGA			81.43701.6905	131 696	AMOR0192
27.	G90, 9...			81.43701.6349	101 993	AMOR0211
28.	TGA			81.43702.6002	311 478	AMOR0322
29.	TGA			81.43702.6011	311 480	AMOR0207
30.	TGL			85.43701.6006	311 891	AMOR0099
31.	TGL			81.43702.6000	311 895	AMOR0098
32.	BUS EL202, 222, 262, NG, NL, NU			81.43701.6713	112 912	AMOR0069
33.	BUS EL202, 222, 262, NG, NL, NU			81.43701.6672	112 913	AMOR0056

MERCEDES

Poz.	Tip vozila	Osovina	Tip veze	OE broj	Sachs broj	RAPIDEX broj
1.	709, 711, 809, 811, 814, 817, 914, 917			006 323 10 00	311 234	AMOR0361
2.	709, 809, 814, 914K, 914KO			005 326 29 00	106 832	AMOR0234
3.	812, 813, 815, 609, 709DK, 711D, 809D, 811, 814			004 326 13 00	310 775	AMOR0231
4.	709, 711, 809, 814, 817, 914, 917			006 323 28 00	310 771	AMOR0209
5.	512, 812, 507, 508, 510, 609, 709, 711, 809, 811, 814			004 323 88 00	112 370	AMOR0214
6.	814, MK, SK, 16-30 t			006 323 09 00	310 789	AMOR0103
7.	814, LK, NG, SK			004 323 45 00	310 772	AMOR0102
8.	MK, SK, 12-30 t			002 323 86 00	112 027	AMOR0068
9.	MK, SK, 16-25 t			002 326 88 00	310 801	AMOR0097
10.	1624, 1922, 2628L, LS			005 323 95 00	310 777	AMOR0091
11.	Atego 712-717			970 326 01 00	131 739	AMOR0111
12.	Atego 712-717			974 326 01 00	131 748	AMOR0323
13.	Atego, Actros			006 323 16 00	124 358	AMOR0243
14.	Actros, 1831-, 2031-, Atego 1823-, Axor			005 326 01 00	131 623	AMOR0005
15.	Actros 1831-, 2031-, Atego 1823-1828			005 326 33 00	125 908	AMOR0006
16.	Actros 1831-, 2031-, 3231-, 4140-, Atego 1823, 2628			005 323 97 00	125 898	AMOR0092

MERCEDES

Poz.	Tip vozila	Osovina	Tip veze	OE broj	Sachs broj	RAPIDEX broj
17.	Actros 1831-, 2031-, Atego 1215, Axor			006 323 51 00	131 056	AMOR0093
18.	Actros 1831-1860			006 323 84 00	290 007	AMOR0174
19.	Actros 1831-, 2031-, 3231-, 4140-, Atego 1823-2523			005 323 95 00	310 805	AMOR0228
20.	Actros 1831-, 2531-, Atego 1823-, 2523-			006 323 33 00	124 639	AMOR0227
21.	Actros 1831-, 2531-, Atego 1823-, 2523-			005 326 12 00	124 360	AMOR0107
22.	Actros 1831-1860, Atego 1823-2628			006 323 71 00	131 747	AMOR0173
23.	Actros 1831-, 2031-, 3231-, Atego 1823-2523, Axor			006 323 78 00	131 944	AMOR0360
24.	Actros 1831-, 2031-, 3231-, 4140-			005 323 96 00	124 678	AMOR0324
25.	Actros 1831-, 2031-, 2631-			005 326 25 00	124 361	AMOR0325
26.	Actros 1831-, 2031-, Atego 1823, Axor			004 326 99 00	131 534	AMOR0326
27.	Actros 1831-, Atego 1823-			005 326 11 00	124 359	AMOR0327
28.	Actros 1831-, 2031-, 3231-, Atego 2523-			005 326 14 00	124 376	AMOR0328
29.	Actros 1831-, 2031-			006 323 54 00	131 622	AMOR0329
30.	Actros 1831-, 2031-, Atego 1823-, 2523-, Axor			005 323 99 00	310 807	AMOR0330
31.	Actros 1831-, 2531-, 3231-, 4140-, Atego 2628			005 326 09 00	124 567	AMOR0331
32.	Atego 1215-, 1317-, 1517-, 1529-			974 323 00 00	125 909	AMOR0332

MERCEDES

Poz.	Tip vozila	Osovina	Tip veze	OE broj	Sachs broj	RAPIDEX broj
33.	Actros 1831-, 2031-, 3231-, Atego 1823-1828			005 326 10 00	124 313	AMOR0333
34.	Actros 1831-, 2031-, 3231-, Atego 1823-1828			006 323 45 00	290 242	AMOR0334
35.	O 405, 407, 408			396 320 00 30	310 792	AMOR0335
36.	O 405, 407, 408			357 326 00 00	310 782	AMOR0336
37.	O 580 Travego			629 323 00 00	280 966	AMOR0337
38.	O 580 Travego			629 326 00 00	290 992	AMOR0338
39.	O 580 Travego			629 326 01 00	300 091	AMOR0339
40.	O 530 Citaro			628 323 01 00	131 828	AMOR0340
41.	O 530 Citaro			628 326 07 00	131 532	AMOR0341
42.	O 345 Conecto, O 530 Citaro			628 326 08 00	290 991	AMOR0342
43.	O 350 Turismo, O 403, O 404			356 323 02 00	124 876	AMOR0343
44.	O 302, 303, 305			000 463 64 32	200 341	AMOR0344

RENAULT

Poz.	Tip vozila	Osovina	Tip veze	OE broj	Sachs broj	RAPIDEX broj
1.	Magnum, Premium, Serija 100			5010130401	310 962	AMOR0345
2.	Magnum			5010294158	131 184	AMOR0346
3.	Major, Midliner P, R, TR - Serija			23512058	110 652	AMOR0347
4.	Major, R - Serija			5000790689	170 191	AMOR0348
5.	Manager, G,			5000731488	110 647	AMOR0349

SCANIA

Poz.	Tip vozila	Osovina	Tip veze	OE broj	Sachs broj	RAPIDEX broj
1.	82, 92, 93, 112, 142,			1 012 044	310 797	AMOR0350
2.	92, 112, 142, Serija 3			1 110 589	112 889	AMOR0351
3.	Serija 3, Serija 4			1 353 105	125 600	AMOR0352
4.	Serija 3, Serija 4, Serija P, R, T			1 371 448	125 598	AMOR0009
5.	Serija 3, Serija 4, Serija P, R, T			1 421 062	125 997	AMOR0353
6.	Serija 3, Serija 4, Serija P, R, T			1 420 474	125 998	AMOR0354
7.	Serija 3, Serija 4, Serija P, R, T			1 478 507	310 786	AMOR0013
8.	Serija 3, Serija 4			1 375 832	290 010	AMOR0355

SCANIA

Poz.	Tip vozila	Osovina	Tip veze	OE broj	Sachs broj	RAPIDEX broj
9.	Serija 4, Serija P, R, T			1 427 423	290 993	AMOR0356
10.	Serija 4, Serija P, R, T			1 438 527	311 892	AMOR0010
11.	Serija 3, Serija 4, Serija P, R, T			1 478 506	131 475	AMOR0011
12.	Serija 3, Serija 4, Serija P, R, T			1 401 877	131 543	AMOR0012



VOLVO

Poz.	Tip vozila	Osovina	Tip veze	OE broj	Sachs broj	RAPIDEX broj
1.	F10, F12, FL7, FL10, FL12			1609553	310 787	AMOR0357
2.	F10, F12, FL7, FL10, FL12			1598814	106 896	AMOR0358
3.	F10, F12, F16, FH12, FH16, FL6, FL7, FL10			1628359	124 248	AMOR0359
4.	FH12, FH16, FM7, FM9, FM10, FM12			1629481	125 647	AMOR0169
5.	FH12, FH16, FL6, FM7, FM9, FM10, FM12			1629405	125 649	AMOR0167
6.	FH12, FH16, FM7, FM9, FM10, FM12			20374546	131 694	AMOR0170
7.	FH12, FM9, FM12			20374543	311 656	AMOR0168
8.	FH12, FH16, FL7, FM9, FM10, FM12			20374545	131 595	AMOR0171
9.	FH400			20769819	312 706	AMOR0129

VOLVO

Poz.	Tip vozila	Osovina	Tip veze	OE broj	Sachs broj	RAPIDEX broj
10.	B 51, 57, 58, B 615-727			150374	101 480	AMOR0249
11.	B9M, B10M			1134748	106 889	AMOR0248
12.	B9M, B10M, C10M			1134749	106 890	AMOR0191
13.	B9M, B10M, B12M			3027422	170 605	AMOR0190
14.	B10M, B12, B12B, B12M			3031626	170 606	AMOR0189
15.	B9M, B10M, B12			3027423	131 029	AMOR0188
16.	B10B, B12			3037213	125 756	AMOR0187
17.	B7L, B7LA, B10BLE, B10L, B10LA, B12B			3112260	131 105	AMOR0185
18.	B7L, B7LA			70302127	311 206	AMOR0184
19.	B7L, B7RLE			70371256	311 662	AMOR0183
20.	BUS			20726168	311 661	AMOR0182

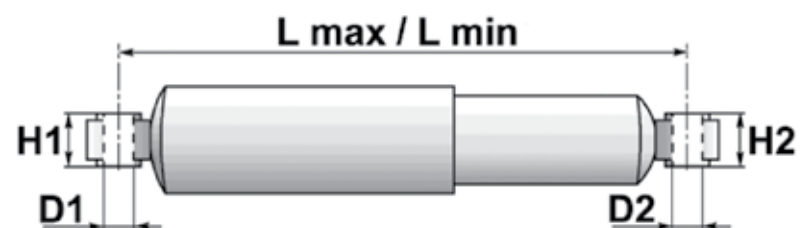



D1, D2 - unutrašnji prečnik čaure
 H1, H2 - visina čaure
 Lmax - dužina amortizera u izvučenom stanju
 Lmin - dužina amortizera u sabijenom stanju

BPW

Poz.	Tip osovine	Lmax ÷ Lmin (mm)	D ₁ x H ₁ (mm)	D ₂ x H ₂ (mm)	OE broj	Monroe broj	RAPIDEX broj
1.	O, ON, ONT 3,6-5,6 t	679 ÷ 413	20 x 55	20 x 55	02.3702.1400	F1113	AMOR0022
2.	O, OM, OT 6-13 t	694 ÷ 427	24 x 55	24 x 55	02.3702.2000	F5007	AMOR0024
3.	O, OM, OT	692 ÷ 429	24 x 55	24 x 55	02.3702.4800	F5008	AMOR0025
4.	O, OM, OT, 6,5-13 t	684 ÷ 424	24 x 55	24 x 55	02.3702.5100	F5009	AMOR0026
5.	OM, OT 6,5-13 t	794 ÷ 477	24 x 55	24 x 55	02.3702.6000	F5010	AMOR0027
6.	OM 6,5-13t	429 ÷ 294	24 x 55	24 x 55	02.3702.7000	F5011	AMOR0028
7.	ZZONT/O.OM, OT, LL, SLO 3-13 t	495 ÷ 327	24 x 55	24 x 55	02.3702.3600	F5073	AMOR0031
8.	O 6-10 t	789 ÷ 477	24 x 55	24 x 55	02.3702.1000	F5126	AMOR0034
9.	O, OM, OT, ON, ONM, ONT	764 ÷ 464	24 x 55	24 x 55	02.3702.1800	F5002	AMOR0057
10.	O, OM, OT 3-13 t	495 ÷ 327	24 x 55	24 x 55	02.3702.1600	F5004	AMOR0058
11.	OM, SL 6,5-13 t	539 ÷ 349	24 x 55	24 x 55	02.3702.9200	F5012	AMOR0061

FREUHAUF

Poz.	Tip osovine	Lmax ÷ Lmin (mm)	D ₁ x H ₁ (mm)	D ₂ x H ₂ (mm)	OE broj	Monroe broj	RAPIDEX broj
1.	Freuhaufl	445 ÷ 315	20 x 50	20 x 50	1518588	F5085	AMOR0067

GIGANT

Poz.	Tip osovine	Lmax ÷ Lmin (mm)	D ₁ x H ₁ (mm)	D ₂ x H ₂ (mm)	OE broj	Monroe broj	RAPIDEX broj
1.	GIGANT	489 ÷ 324	24 x 55	24 x 55	196103	F5083	AMOR0033
2.	GIGANT	764 ÷ 464	24 x 55	24 x 55	196116	F5002	AMOR0057
3.	GIGANT	495 ÷ 327	24 x 55	24 x 55	196107	F5004	AMOR0058
4.	GIGANT	429 ÷ 294	24 x 55	24 x 55	196119	F5011	AMOR0028
5.	GIGANT	495 ÷ 327	24 x 55	24 x 55	196115	F5073	AMOR0031

KÄSSBOHRER

Poz.	Tip osovine	Lmax ÷ Lmin (mm)	D ₁ x H ₁ (mm)	D ₂ x H ₂ (mm)	OE broj	Monroe broj	RAPIDEX broj
1.	Kässbohrer	560 ÷ 360	16 x 49	16 x 49	8.231.293.100	F5157	AMOR0036

R.O.R.

Poz.	Tip osovine	Lmax ÷ Lmin (mm)	D ₁ x H ₁ (mm)	D ₂ x H ₂ (mm)	OE broj	Monroe broj	RAPIDEX broj
1.	Flexair FL9000, FL11000	428 ÷ 303	24 x 58	24 x 58	21222271	F5015	AMOR0030

SAF

Poz.	Tip osovine	Lmax ÷ Lmin (mm)	D ₁ x H ₁ (mm)	D ₂ x H ₂ (mm)	OE broj	Monroe broj	RAPIDEX broj
1.	AR200	616 ÷ 383	20 x 44	20 x 44	2.376.0003.00	F1068	AMOR0021
2.	AR221	714 ÷ 436	20 x 44	20 x 44	2.376.0016.00	F1119	AMOR0023
3.	AR421	559 ÷ 359	20 x 62	20 x 62	2.376.0020.00	F5127	AMOR0035
4.	Intradisc Plus II	413 ÷ 278	20 x 78	20 x 68	2.376.0070.00	F5174	AMOR0037
5.	Intradisc Plus II	491 ÷ 315	20 x 78	20 x 68	2.376.0071.00	F5175	AMOR0038
6.	AR413 Specijal, AR213, 413, 416	477 ÷ 319	20 x 62	20 x 62	2.376.0010.01	F5254	AMOR0060
7.	AR413	465 ÷ 315	24 x 62	24 x 62	2.376.0005.00	F5020	AMOR0088
8.	AR313	635 ÷ 385	19 x 44	19 x 44	2.376.0002.00	V2097	AMOR0042

SCHMITZ

Poz.	Tip osovine	Lmax ÷ Lmin (mm)	D ₁ x H ₁ (mm)	D ₂ x H ₂ (mm)	OE broj	Monroe broj	RAPIDEX broj
1.	Weweler	475 ÷ 320	20 x 62	20 x 62	902398	F5025	AMOR0029
2.	Cargobull	489 ÷ 324	24 x 55	24 x 55	196103	F5083	AMOR0033
3.	Weweler	425 ÷ 295	20 x 62	20 x 62	017090	F5075	AMOR0032
4.	Cargobull	495 ÷ 327	24 x 55	24 x 55	020044	F5125	AMOR0059

DAF

Poz.	Tip vozila	Mesto ugradnje	Tip veze	Monroe broj	OE broj	RAPIDEX broj
1.	95XF 380-530, XF95			CB0042	1303516	AMOR0019
2.	95, 95XF, XF95, XF105			CBO033	1265281	KABI0082
3.	95XF 97/01→02/09, XF95 02/09→XF105 06/01→			CB0044	1319672	AMOR0020
4.	95, 95XF, XF95, XF105			CB0034	1353451	AMOR0258

IVECO

Poz.	Tip vozila	Mesto ugradnje	Tip veze	Sachs broj	OE broj	RAPIDEX broj
1.	Euro Star, Euro Tech MP, Euro Trakker			115 743	500348793	AMOR0259
2.	Stralis 02/02→			310 820	500357351	AMOR0178
3.	Stralis 02/02→			310 821	500357352	AMOR0196

MAN

Poz.	Tip vozila	Mesto ugradnje	Tip veze	Sachs broj	OE broj	RAPIDEX broj
1.	F90			112 211	81.41722.6014	AMOR0177
2.	F2000			112 211	81.41722.6014	AMOR0177
3.	F90, F90 Unterflur, F2000			112 855	81.41722.6009	AMOR0108
4.	F90, F90 Unterflur, F2000			112 856	81.41722.6010	AMOR0215



MAN						
Poz.	Tip vozila	Mesto ugradnje	Tip veze	Sachs broj	OE broj	RAPIDEX broj
5.	F2000 94/01→			105 855	81.41722.6051	AMOR0229
6.	F2000 94/01→, TGA 28.310-530 00/03→			105 856	81.41722.6052	AMOR0175
7.	F90, F90 Unterflur, F2000 94/01→			112 884	81.41722.6050	AMOR0261
8.	F90, F90 Unterflur, F2000 94/01→			112 885	81.41722.6045	AMOR0362
9.	F2000, L2000, M90, M2000L			112 321	81.43701.6629	AMOR0260
10.	L2000, M2000L			123 890	85.41722.6001	AMOR0262
11.	TGA 18.280-510, 26.310-530, 33.350-530 00/03→			290 977	85.41722.6010	AMOR0001
12.	TGA 18.280-510, 26.310-530, 33.350-530 00/03→			290 975	85.41722.6017	AMOR0193
13.	TGA 18.280-510, 26.310-530, 33.350-530, 41.480-660 00/03→			135 196	85.41722.6014	AMOR0195
14.	TGA 18.280-510, 26.310-530, 33.350-480 00/03→			313 182	85.41722.6015	AMOR0127
15.	TGA 18.280-510, 26.310-530, 33.350-530 00/03→			290 976	85.41722.6019	AMOR0194
16.	TGA 18.280-510, 26.310-530, 33.350-530 00/03→			290 978	85.41722.6011	AMOR0263
17.	TGA 18.280-510, 26.310-530, 33.350-530, 41.480-660 00/03→			135 198	85.41722.6012	AMOR0206
18.	TGA 18.280-510, 26.310-530, 33.350-530, 41.480-660 00/03→			313 183	85.41722.6012	AMOR0126
19.	TGA 18.280-510, 26.310-530, 33.350-530 00/03→, TGL 7.150-12.240 05/04→			135 200	85.41722.6013	AMOR0204



MAN						
Poz.	Tip vozila	Mesto ugradnje	Tip veze	Sachs broj	OE broj	RAPIDEX broj
20.	TGA 18.280-510, 26.310-530, 33.350-530, 41.480-660 00/03→			300 013	81.41722.6053	AMOR0172
21.	TGA 18.280-510, 26.310-530, 33.350-530, 41.480-660 00/03→			300 015	81.41722.6055	AMOR0202



MERCEDES						
Poz.	Tip vozila	Mesto ugradnje	Tip veze	Sachs broj	OE broj	RAPIDEX broj
1.	LK, NG 1013-2636			101 329	387 890 16 19	AMOR0125
2.	NG, SK Serija			101 456	000 891 18 05	AMOR0080
3.	Actros 1831-, 2031-, 2531-, 3231-, 4140-			290 997	942 890 02 19	AMOR0083
4.	Actros 1831-4148 96/06→, Atego 1823-2628			290 268	942 890 05 19	AMOR0156
5.	Actros 1831S, LS- 1853S, LS			105 392	942 890 29 19	AMOR0082
6.	Actros 1831S, LS- 1853S, LS			131 850	942 890 28 19	AMOR0109
7.	Actros 1831-, 2031-, 2531-, 3231-, 4140-			290 257	942 890 38 19	AMOR0130
8.	Actros 1831-, 2031-, 2531-, 3231-, 4140-			290 998	942 890 53 19	AMOR0199
9.	Actros 1831-, 2031-, 2531-, 3231-, 4140-			290 250	942 890 54 19	AMOR0203
10.	Actros 1831-, 2031-, 2531-, 3231-, 4140-			290 246	942 890 11 19	AMOR0198
11.	Actros 1831-, 2031-, 2531-, 3231-, 4140-			290 249	942 890 56 19	AMOR0197

MERCEDES

Poz.	Tip vozila	Mesto ugradnje	Tip veze	Sachs broj	OE broj	RAPIDEX broj
12.	Actros 1831-, 2031-, 2531-, 3231-, 4140-			290 259	942 890 50 19	AMOR0213
13.	Actros 1831-, 2031-, 2531-, 3231-, 4140-			105 423	942 890 23 19	AMOR0086
14.	Actros 1831-, 2031-, 2531-, 3231-, 4140-			311 663	943 890 38 19	AMOR0114
15.	Actros 1831-, 2031-, 2531-, 3231-, 4140-			290 245	942 890 04 19	AMOR0210
16.	Actros 1831-, 2031-, 2531-, 3231-, 4140-			290 247	942 890 36 19	AMOR0161
17.	Actros 1831-, 2031-, 2531-, 3231-			131 275	942 890 47 19	AMOR0085
18.	Atego 1823-1828, 2523-2528 Axor 1823-3238			135 066	940 890 08 19	AMOR0048
19.	Atego 1215, 1215L, 1517, 1517L			131 676	970 317 17 03	AMOR0264
20.	Atego 1215, 1215L, 1517, 1517L			131 726	970 317 18 03	AMOR0265
21.	Atego 1823-1828, 2523-2628, Axor 1823-3238			290 251	940 890 38 19	AMOR0266
22.	Atego 1823-1828, 2523-2628, Axor 1823-3238			290 995	940 890 39 19	AMOR0267

RENAULT

Poz.	Tip vozila	Mesto ugradnje	Tip veze	Sachs broj	OE broj	RAPIDEX broj
1.	Magnum 400.18-480.26 00/05→			-	5010228849	AMOR0043
2.	Kerax 97/06→, Premium 96/04→			310 957	5010228908	AMOR0115
3.	Magnum AE 385.18-560.26 90/09→			124 735	5010052404	AMOR0268
4.	Magnum AE 385.18-560.26 90/09→			124 737	5010052405	AMOR0269
5.	Premium 00/01→			135 050	5010269605	AMOR0270

SCANIA

Poz.	Tip vozila	Mesto ugradnje	Tip veze	Monroe broj	OE broj	RAPIDEX broj
1.	94, 114, 124, 144, 164			CB0058	1 363 120	AMOR0077
2.	94, 114, 124, 144, 164			CB0059	1 349 844	AMOR0078
3.	94, 114, 124, 144, 164		jastuk	CB0067	1 349 840	AMOR0079
4.	94, 114, 124, 144, 164			CB0009	1 381 906	AMOR0073
5.	94, 114, 124, 144, 164		jastuk	CB0030	1 381 919	AMOR0018
6.	94, 114, 124, 144, 164, P, R Serija		jastuk	CB0074	1 592 468	AMOR0081
7.	94, 114, 124, 144, 164, P, R Serija			CB0010	1 381 904	AMOR0074

VOLVO

Poz.	Tip vozila	Mesto ugradnje	Tip veze	Monroe broj	OE broj	RAPIDEX broj
1.	FH12, FH16			CB0003	1629719	AMOR0015
2.	FH12, FH16, FM7, FM9, FM10, FM12			CB0007	1622227	AMOR0016
3.	FH12, FH16			CB0029	1629721	AMOR0017
4.	FH400-520			CB0040	3198836	AMOR0076
5.	FH400-520, FH12, FH16			CB0028	1629722	AMOR0075
Poz.	Tip vozila	Mesto ugradnje	Tip veze	Sachs broj	OE broj	RAPIDEX broj
6.	FH400-520, FM300-480, FM7, FM10, FM12			312 694	1075445	AMOR0004
7.	F7, FL7, FL10			312 272	1594088	AMOR0271

GASNI AMORTIZERI

Poz.	Tip vozila	Dužina L (mm)	Sila F (N)	SE-M broj	OE broj	RAPIDEX broj
1.	DAF 95, 95XF, XF95	530	400	8384	1238280	AMOR0145
2.	MAN F2000	720	220	8376	81.74821.0095	AMOR0140
3.	MAN TGA, TGX - XXL	685	220	8375	81.61140.0016	AMOR0139
4.	MAN TGA 460A - XXL	480	50	8378	81.74821.0149	AMOR0141
5.	MAN TGA 460A - XXL	480	350	8379	81.74821.0039	AMOR0142
6.	MERCEDES MK, SK	750	220	8381	000 980 90 64	AMOR0143
7.	MERCEDES AXOR	610	360	8382	001 980 84 64	AMOR0144
8.	RENAULT PREMIUM	600	350	8397	-	AMOR0150
9.	VOLVO FH12, FH16	530	150	8386	1619106	AMOR0146

608N				
	Contitech broj	OE broj	Primena / Opis	RAPIDEX broj
	608N	4731003000	Kässbohrer, BPW	VESA0574

620N 8 bar				
	Contitech broj	OE broj	Primena / Opis	RAPIDEX broj
	620N 8 bar	02.200.20.80.0	BPW	VESA0930

644N				
	Contitech broj	OE broj	Primena / Opis	RAPIDEX broj
	644N	307 328 00 01	EVO Bus, Volvo	VESA0686

661N				
	Contitech broj	OE broj	Primena / Opis	RAPIDEX broj
	661N	100112250	Neoplan, Kässbohrer	VESA0617

662N				
	Contitech broj	OE broj	Primena / Opis	RAPIDEX broj
	662N	11016348	Neoplan	VESA0706

673N				
	Contitech broj	OE broj	Primena / Opis	RAPIDEX broj
	673N	621 328 00 01	Mercedes SK, različiti tipovi	VESA0767

701N				
	Contitech broj	OE broj	Primena / Opis	RAPIDEX broj
		701N	B 510040	Ikarus, Bova

706N				
	Contitech broj	OE broj	Primena / Opis	RAPIDEX broj
		706N	81.43601.0101	MAN F90, F2000

713N				
	Contitech broj	OE broj	Primena / Opis	RAPIDEX broj
		713N	6797169	Volvo

715N				
	Contitech broj	OE broj	Primena / Opis	RAPIDEX broj
		715N	363 329 00 01	Mercedes, zadnja osovina

716N				
	Contitech broj	OE broj	Primena / Opis	RAPIDEX broj
		716N	81.43601.0040	Man prednja osovina, Volvo F10-12

719N				
	Contitech broj	OE broj	Primena / Opis	RAPIDEX broj
		719N	02.200.24.00.0	BPW, Gigant, Daf, Neoplan, Kässbohrer

720N				
Contitech broj	OE broj	Primena / Opis	RAPIDEX broj	
720N	81.43601.0037	Man, Mercedes SK, Neoplan, Volvo Prednja i zadnja osovina	VESA0422	

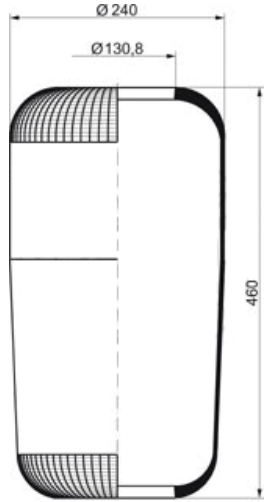

724N				
Contitech broj	OE broj	Primena / Opis	RAPIDEX broj	
724N	246169	Gigant 3053, različite serije	VESA0934	

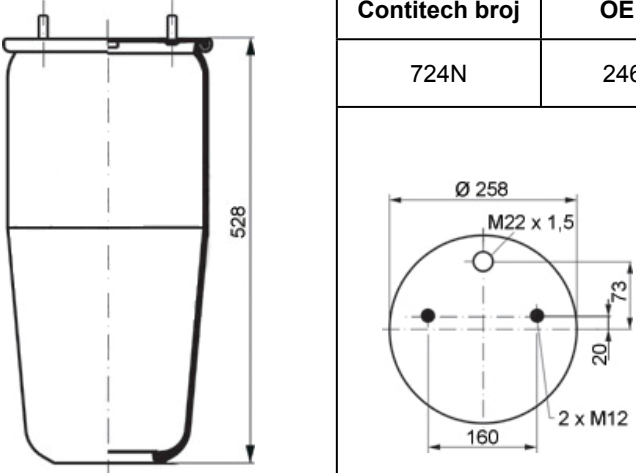

725N				
Contitech broj	OE broj	Primena / Opis	RAPIDEX broj	
725N	0246-149	Gigant 3653	VESA0935	

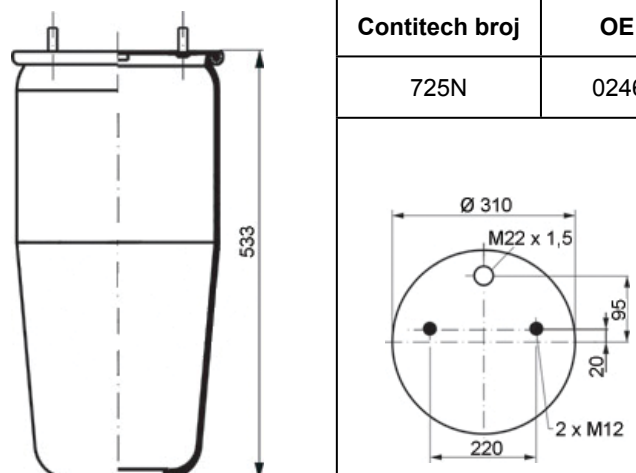

725NP02				
Contitech broj	OE broj	Primena / Opis	RAPIDEX broj	
725NP02	166217	Gigant 3653 sa centralnim vijkom	VESA0936	

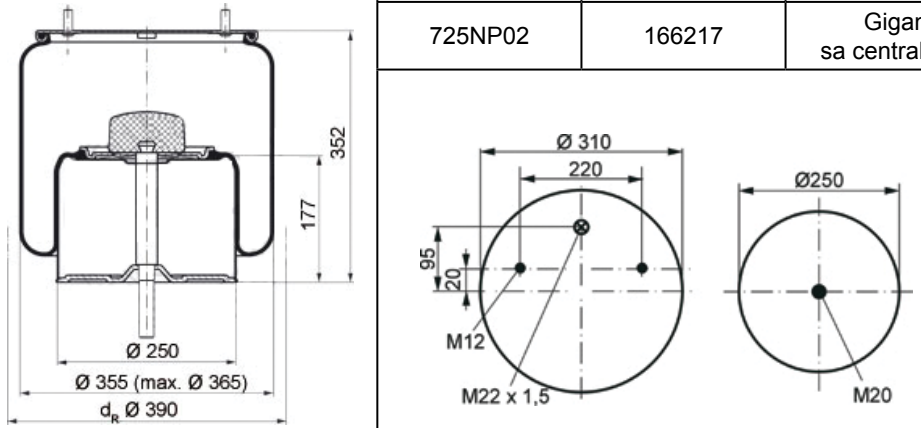

725NP03				
Contitech broj	OE broj	Primena / Opis	RAPIDEX broj	
725NP03	166252	Gigant 3653	VESA0937	

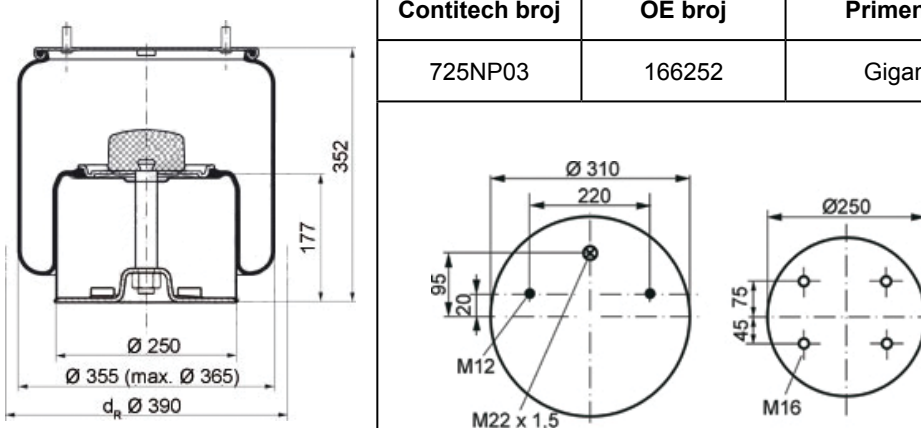

727N				
Contitech broj	OE broj	Primena / Opis	RAPIDEX broj	
727N	81.43601.0076	Man, Daf, Gigant, BPW, van Hool	VESA0938	

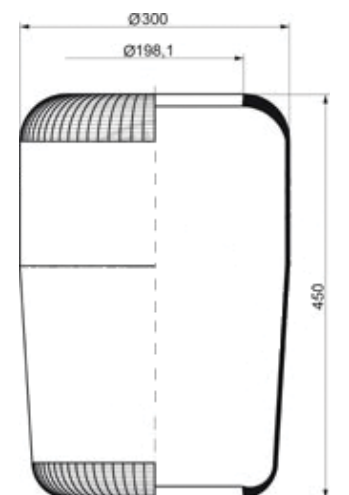

728N				
	Contitech broj	OE broj	Primena / Opis	RAPIDEX broj
		728N	750212	SCHMITZ

737N				
	Contitech broj	OE broj	Primena / Opis	RAPIDEX broj
		737N	393 328 02 01	Mercedes MK, SK

757N				
	Contitech broj	OE broj	Primena / Opis	RAPIDEX broj
		757N	363 328 02 01	Mercedes MK, SK, prednja osovina

762N				
	Contitech broj	OE broj	Primena / Opis	RAPIDEX broj
		762N	02.200.24.20.0	BPW, MAN, Kässbohrer, Neoplan, Ikarus

775N				
	Contitech broj	OE broj	Primena / Opis	RAPIDEX broj
		775N	196038	Gigant, Kässbohrer

782N				
	Contitech broj	OE broj	Primena / Opis	RAPIDEX broj
		782N	5000954173	Renault, Iveco Euro Tech, zadnja osovina

786N				
	Contitech broj	OE broj	Primena / Opis	RAPIDEX broj
		786N	81.43601.0053	MAN

788N				
	Contitech broj	OE broj	Primena / Opis	RAPIDEX broj
		788N	674 328 03 01	Mercedes, Neoplan, Renault, Volvo

810MB				
	Contitech broj	OE broj	Primena / Opis	RAPIDEX broj
		810MB	2.229.0002.00	SAF 2918, ROR, Scania

810NT				
	Contitech broj	OE broj	Primena / Opis	RAPIDEX broj
		810NT	81.43601.0047	MAN

811MB				
	Contitech broj	OE broj	Primena / Opis	RAPIDEX broj
		811MB	1322720	SAF

813MB				
	Contitech broj	OE broj	Primena / Opis	RAPIDEX broj
		813MB	2.229.0003.00	SAF 2923, Hendrickson, ROR

819N				
	Contitech broj	OE broj	Primena / Opis	RAPIDEX broj
		819N	000 328 01 01	Mercedes Vario, prednja i zadnja osovina

836M				
	Contitech broj	OE broj	Primena / Opis	RAPIDEX broj
		836M	0067504	Daf

836MB				
	Contitech broj	OE broj	Primena / Opis	RAPIDEX broj
		836MB	0513985	Daf

838N				
	Contitech broj	OE broj	Primena / Opis	RAPIDEX broj
		838N	674 328 00 01	Mercedes LK, zadnja osovina

876N				
	Contitech broj	OE broj	Primena / Opis	RAPIDEX broj
		876N	5000296816	Renault

881MB				
	Contitech broj	OE broj	Primena / Opis	RAPIDEX broj
		881MB	05.429.40.01.0	BPW (O, OM, OT, SL, AL)

882N1				
	Contitech broj	OE broj	Primena / Opis	RAPIDEX broj
		882N1	81.43601.0121	MAN F2000, F90, zadnja osovina

883N1				
	Contitech broj	OE broj	Primena / Opis	RAPIDEX broj
		883N1	81.43601.0071	MAN F2000, F90

884N				
	Contitech broj	OE broj	Primena / Opis	RAPIDEX broj
		884N	81.43601.0071	MAN, prednja i zadnja osovina Mercedes, Renault, Iveco

896N				
	Contitech broj	OE broj	Primena / Opis	RAPIDEX broj
		896N	411627	Scania

897N				
	Contitech broj	OE broj	Primena / Opis	RAPIDEX broj
		897N	411622	Scania

916N1				
	Contitech broj	OE broj	Primena / Opis	RAPIDEX broj
		916N1	81.43601.0095	MAN, prednja i zadnja osovina

940MB				
	Contitech broj	OE broj	Primena / Opis	RAPIDEX broj
	940MB	05.429.40.91.0	BPW (30 K)	VESA0760

941MB				
	Contitech broj	OE broj	Primena / Opis	RAPIDEX broj
	941MB	05.429.40.03.0	BPW (30)	VESA0772

942MB				
	Contitech broj	OE broj	Primena / Opis	RAPIDEX broj
	942MB	05.429.40.05.0	BPW (36-1)	VESA0576

946NP02				
	Contitech broj	OE broj	Primena / Opis	RAPIDEX broj
	946NP02	-	EVO Bus	VESA0072

1885N1				
	Contitech broj	OE broj	Primena / Opis	RAPIDEX broj
	1885N1	81.43601.0104	MAN F2000, F90, prednja i zadnja osovina (zamenjuje 1884 n1)	VESA0650

1888N				
	Contitech broj	OE broj	Primena / Opis	RAPIDEX broj
	1888N	81.43601.0163	MAN TGA, TGS, TGX (prednja osovina)	VESA0171

4004NP02			
Contitech broj	OE broj	Primena / Opis	RAPIDEX broj
4004NP02	4.284.3003.01	SAF 2618	VESA0640

4004NP03			
Contitech broj	OE broj	Primena / Opis	RAPIDEX broj
4004NP03	3.229.0007.00	SAF 2618	VESA0953

4022NP03			
Contitech broj	OE broj	Primena / Opis	RAPIDEX broj
4022NP03	3.229.0029.00	SAF 2618V	VESA0068

4022NP05			
Contitech broj	OE broj	Primena / Opis	RAPIDEX broj
4022NP05	3.229.0033.00	SAF 2619V	VESA0483

4023NP03			
Contitech broj	OE broj	Primena / Opis	RAPIDEX broj
4023NP03	3.229.0031.00	SAF 2923 V	VESA0487

4028NP02			
Contitech broj	OE broj	Primena / Opis	RAPIDEX broj
4028NP02	015323	Schmitz, Weweler	VESA0600

4156NP01				
	Contitech broj	OE broj	Primena / Opis	RAPIDEX broj
	4156NP01	-	ROR, Hendrickson	VESA0954

4157NP04				
	Contitech broj	OE broj	Primena / Opis	RAPIDEX broj
	4157NP04	21221307	ROR	VESA0132

4157NP05				
	Contitech broj	OE broj	Primena / Opis	RAPIDEX broj
	4157NP05	21222442	Weweler, ROR	VESA0955

4157NP06				
	Contitech broj	OE broj	Primena / Opis	RAPIDEX broj
	4157NP06	US 06316	Weweler, Schmitz	VESA0956

4157NP09				
	Contitech broj	OE broj	Primena / Opis	RAPIDEX broj
	4157NP09	21222442	ROR	VESA0957

4158NP02				
	Contitech broj	OE broj	Primena / Opis	RAPIDEX broj
	4158NP02	-	Schmitz, Weweler	VESA0958

4158NP03			
Contitech broj	OE broj	Primena / Opis	RAPIDEX broj
4158NP03	750999	Schmitz	VESA0520

4159NP03			
Contitech broj	OE broj	Primena / Opis	RAPIDEX broj
4159NP03	-	Fruehauf, (zamena za 4159NP14)	VESA0959

4159NP05			
Contitech broj	OE broj	Primena / Opis	RAPIDEX broj
4159NP05	-	Fruehauf	VESA0405

4159NP07			
Contitech broj	OE broj	Primena / Opis	RAPIDEX broj
4159NP07	UJB 0203001	Fruehauf, Trailor	VESA0087

4183NP24			
Contitech broj	OE broj	Primena / Opis	RAPIDEX broj
4183NP24	942 320 23 21	Mercedes Actros MP2 (jedan priključak za vazduh Voss 232)	VESA0227

4185NP21			
Contitech broj	OE broj	Primena / Opis	RAPIDEX broj
4185NP21	942 320 30 21	Mercedes Atego (jedan priključak za vazduh Voss 232)	VESA0960

4187NP21				
Contitech broj	OE broj	Primena / Opis	RAPIDEX broj	
4187NP21	-	Mercedes Actros MP2 (jedan priključak za vazduh Voss 232)	OSOVO032	

4390N1				
Contitech broj	OE broj	Primena / Opis	RAPIDEX broj	
4390N1	942 328 00 01	Mercedes Actros (jedan priključak za vazduh)	VESA0295	

4390N2				
Contitech broj	OE broj	Primena / Opis	RAPIDEX broj	
4390N2	942 328 01 01	Mercedes Actros (dva priključka za vazduh)	VESA0644	

4390NP01				
Contitech broj	OE broj	Primena / Opis	RAPIDEX broj	
4390NP01	942 320 01 21	Mercedes Actros, zadnja osovina	VESA0421	

4390NP02				
Contitech broj	OE broj	Primena / Opis	RAPIDEX broj	
4390NP02	942 320 02 21	Mercedes Atego, Actros	VESA0646	

4391NP22				
Contitech broj	OE broj	Primena / Opis	RAPIDEX broj	
4391NP22	942 320 54 21	Mercedes Actros (dva priključka za vazduh Voss 232)	VESA0961	

4705N1P01			
Contitech broj	OE broj	Primena / Opis	RAPIDEX broj
4705N1P01	81.43601.6068	MAN TGA	VESA0962

4713NP02			
Contitech broj	OE broj	Primena / Opis	RAPIDEX broj
4713NP02	1076594	Volvo F, FH, zadnja osovina	VESA0653

4737NP01			
Contitech broj	OE broj	Primena / Opis	RAPIDEX broj
4737NP01	946 320 03 21	Mercedes Actros (jedan priključak za vazduh Voss 230)	VESA0963

4757N1			
Contitech broj	OE broj	Primena / Opis	RAPIDEX broj
4757N1	942 327 00 01	Mercedes Atego, Actros	VESA0964

4757N2			
Contitech broj	OE broj	Primena / Opis	RAPIDEX broj
4757N2	974 328 00 01	Mercedes Atego, Actros	VESA0965

4757NP01			
Contitech broj	OE broj	Primena / Opis	RAPIDEX broj
4757NP01	942 320 01 17	Mercedes Atego, Actros, Econic Prednja osovina	VESA0420

4757NP09				
	Contitech broj	OE broj	Primena / Opis	RAPIDEX broj
	4757NP09	974 320 04 17	Mercedes Atego, prednja i zadnja osovina	VESA0486

4759NP01				
	Contitech broj	OE broj	Primena / Opis	RAPIDEX broj
	4759NP01	942 320 02 17	Mercedes Actros	VESA0966

4810NP05				
	Contitech broj	OE broj	Primena / Opis	RAPIDEX broj
	4810NP05	3229002700	SAF, različite serije	VESA0128

4813NP07				
	Contitech broj	OE broj	Primena / Opis	RAPIDEX broj
	4813NP07	1 314 906	Scania serija 3, zadnja osovina	VESA0412

4838NP01				
	Contitech broj	OE broj	Primena / Opis	RAPIDEX broj
	4838NP01	946 320 04 21	Mercedes Actros	VESA0967

4881NP02				
	Contitech broj	OE broj	Primena / Opis	RAPIDEX broj
	4881NP02	0542941010	BPW (36 K)	VESA0666

4882N1P01			
Contitech broj	OE broj	Primena / Opis	RAPIDEX broj
4882N1P01	81.43601.0151	MAN TGA	VESA0762

4882N1P05			
Contitech broj	OE broj	Primena / Opis	RAPIDEX broj
4882N1P05	81.43601.6041	MAN TGA (zadnja osovina)	VESA0229

4883N1P01			
Contitech broj	OE broj	Primena / Opis	RAPIDEX broj
4883N1P01	81.43601.0153	MAN TGA	VESA0402

4884N1P01			
Contitech broj	OE broj	Primena / Opis	RAPIDEX broj
4884N1P01	81.43601.0152	MAN TGA, zadnja osovina	VESA0406

4884N1P06			
Contitech broj	OE broj	Primena / Opis	RAPIDEX broj
4884N1P06	81.43600.6035	MAN TGA, TGX, TGS	VESA0231

4912NP07			
Contitech broj	OE broj	Primena / Opis	RAPIDEX broj
4912NP07	5010294307	RENAULT (zamena za 4912NP05)	VESA0233

4912NP08			
Contitech broj	OE broj	Primena / Opis	RAPIDEX broj
4912NP08	5001832067	RENAULT	VESA0223

4912NP10			
Contitech broj	OE broj	Primena / Opis	RAPIDEX broj
4912NP10	-	RENAULT, (jedan priključak za vazduh)	VESA0234

4913NP02			
Contitech broj	OE broj	Primena / Opis	RAPIDEX broj
4913NP02	1 379 392	Scania serija 4, zadnja osovina	VESA0498

4913NP04			
Contitech broj	OE broj	Primena / Opis	RAPIDEX broj
4913NP04	1 379 393	Scania serija 4, zadnja osovina	VESA0779

4940NP02			
Contitech broj	OE broj	Primena / Opis	RAPIDEX broj
4940NP02	05.429.42.56.0	BPW (30 K)	VESA0968

4960NP02			
Contitech broj	OE broj	Primena / Opis	RAPIDEX broj
4960NP02	05.429.41.77.0	BPW (30 K)	VESA0969

5

5

6605NP01				
	Contitech broj	OE broj	Primena / Opis	RAPIDEX broj
	6605NP01	3171692	Volvo	VESA0283

6606NP01				
	Contitech broj	OE broj	Primena / Opis	RAPIDEX broj
	6606NP01	20427801	Volvo	VESA0284

6608NP01				
	Contitech broj	OE broj	Primena / Opis	RAPIDEX broj
	6608NP01	20582215	Volvo	VESA0287

6609NP01				
	Contitech broj	OE broj	Primena / Opis	RAPIDEX broj
	6609NP01	20452138	Volvo FH12	VESA0970

RZ 415-25				
	Contitech broj	OE broj	Primena / Opis	RAPIDEX broj
	RZ 415-25	3027271	Volvo	VESA0493

RZ 415-28				
	Contitech broj	OE broj	Primena / Opis	RAPIDEX broj
	RZ 415-28	3027272	Volvo	VESA0971

RZ 450-25				
Contitech broj	OE broj	Primena / Opis	RAPIDEX broj	
RZ 450-25	356 327 02 01	Mercedes, EvoBus, O404, O350	VESA0972	

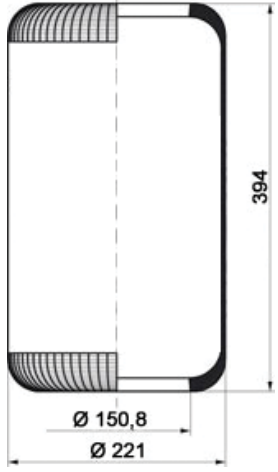

2 B 34 R-B				
Contitech broj	OE broj	Primena / Opis	RAPIDEX broj	
2 B 34 R-B	473 103 41 00	Kässbohrer	VESA0973	

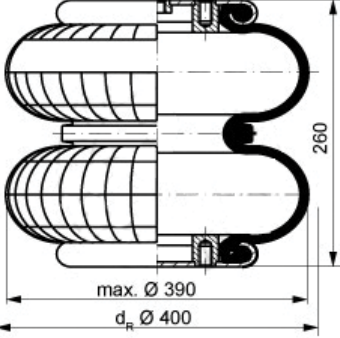

SZ 51-5				
Contitech broj	OE broj	Primena / Opis	RAPIDEX broj	
SZ 51-5	-	Vazdušni jastuk sedišta C.O.B.O.	VESA0458	

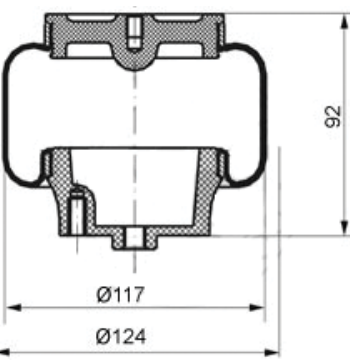
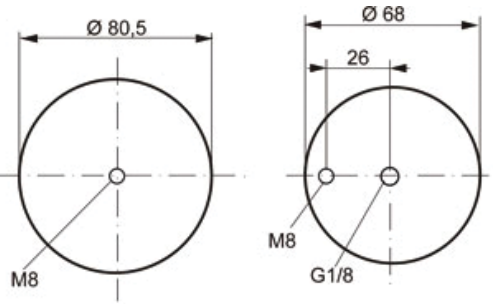

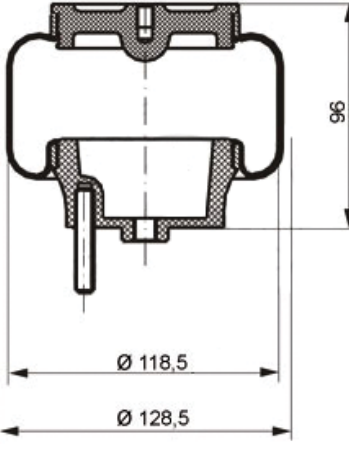
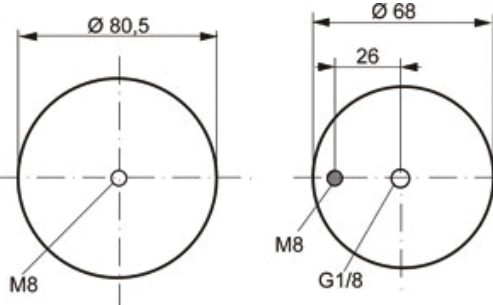

SZ 51-7				
Contitech broj	OE broj	Primena / Opis	RAPIDEX broj	
SZ 51-7	-	Vazdušni jastuk sedišta Pilot	VESA0974	

SA 51-10				
Contitech broj	OE broj	Primena / Opis	RAPIDEX broj	
SA 51-10	-	Vazdušni jastuk sedišta Möve	VESA0457	

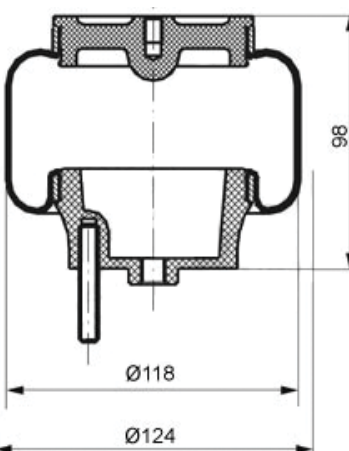
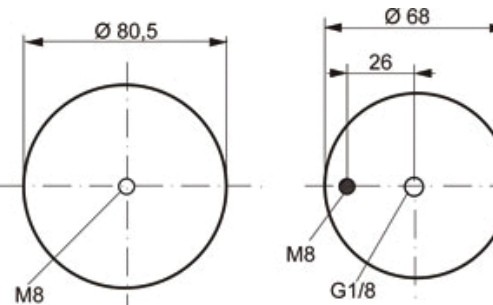

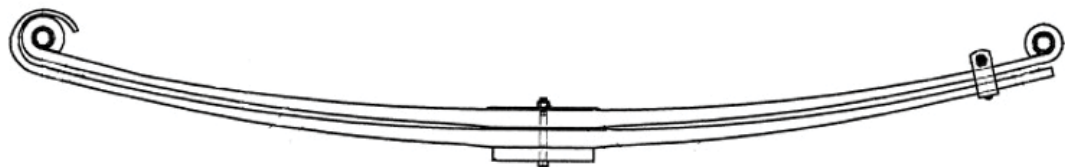

DAF (prednja osovina)

Poz.	Tip vozila	Opterećenje (t)	Širina (mm)	Broj listova x debljina lista (mm)	Dužina Lx/Ly (mm)	OE broj	RAPIDEX broj
1.	65CF, 75CF, 85CF, 95XF	6,5	80	2 x 32 1 x 23	900/900	1279672	VESA0278
2.	65CF, 75CF, 85CF, 95XF, XF95	7,1	80	1 x 28 1 x 30	900/900	1381683	VESA0279

IVECO (prednja osovina)

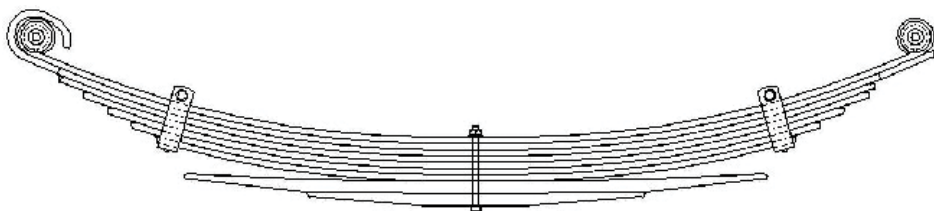
Poz.	Tip vozila	Opterećenje (t)	Širina (mm)	Broj listova x debljina lista (mm)	Dužina Lx/Ly (mm)	OE broj	RAPIDEX broj
1.	Eurocargo 130E18, 150E15-27, Tector 130E18-24, 150E18-28	-	80	8 x 13	879/879	98447663	VESA0310

IVECO (zadnja osovina)

Poz.	Tip vozila	Opterećenje (t)	Širina (mm)	Broj listova x debljina lista (mm)	Dužina Lx/Ly (mm)	OE broj	RAPIDEX broj
2.	Eurocargo 75E12-15, Tector 75E13-18	-	70	2 x 16 1 x 40 1 x 27	835/835	99445125	VESA0311
3.	Eurocargo 65E12H, 75E13-18, Tector 75E13-18	-	70	4 x 12 3 x 22	835/835	99445128	VESA0312

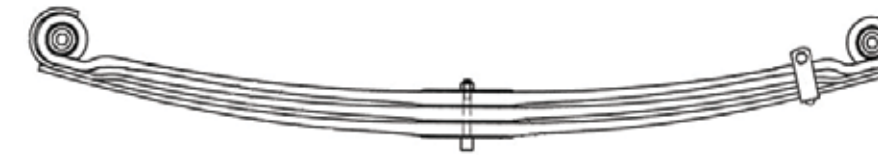
IVECO (prednja osovina)

Poz.	Tip vozila	Opterećenje (t)	Širina (mm)	Broj listova x debljina lista (mm)	Dužina Lx/Ly (mm)	OE broj	RAPIDEX broj
4.	Eurotrakker 340E34-37, 410E42	-	90	3 x 25	760/760	8161631	VESA0313

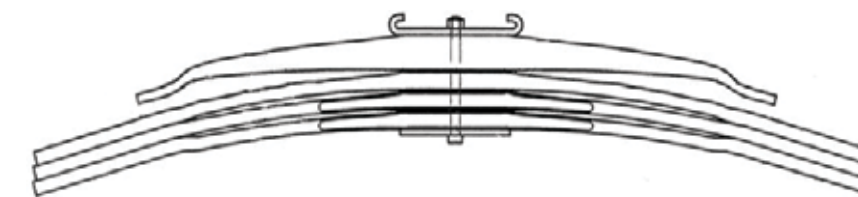
IVECO (zadnja osovina)

Poz.	Tip vozila	Opterećenje (t)	Širina (mm)	Broj listova x debljina lista (mm)	Dužina Lx/Ly (mm)	OE broj	RAPIDEX broj
5.	Eurotrakker, Eurotrakker Cursor	13,0	100	3 x 26 1 x 53 1 x 10	730/730	42126135	VESA0314

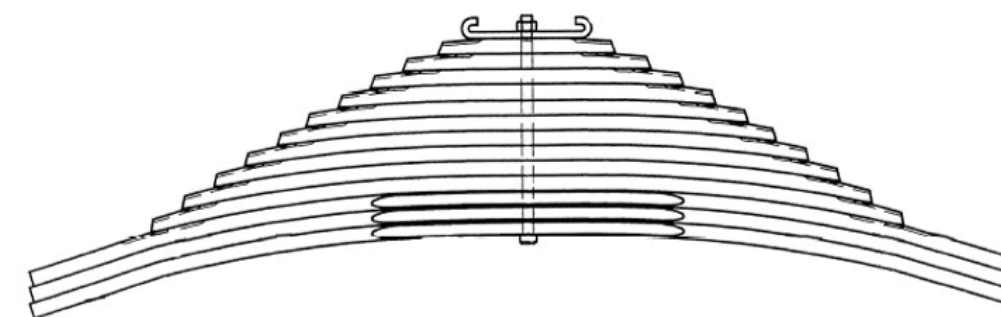
IVECO (zadnja osovina)

Poz.	Tip vozila	Opterećenje (t)	Širina (mm)	Broj listova x debljina lista (mm)	Dužina Lx/Ly (mm)	OE broj	RAPIDEX broj
6.	Eurotrakker, Eurotrakker Cursor	16,0	100	13 x 22 1 x 10	730/730	42121640	VESA0315

IVECO (prednja osovina) EUROTECH CURSOR, EUROSTAR CURSOR, STRALIS

Poz.	Tip vozila	Opterećenje (t)	Širina (mm)	Broj listova x debljina lista (mm)	Dužina Lx/Ly (mm)	OE broj	RAPIDEX broj
7.	190E31-43, 260E31-39, 440E35-39, Stralis 190S27-50, 260S27-50	-	90	1 x 25 1 x 40	950/931	500355490	VESA0316

IVECO (prednja osovina) EUROTECH, EUROTECH CURSOR, STRALIS

Poz.	Tip vozila	Opterećenje (t)	Širina (mm)	Broj listova x debljina lista (mm)	Dužina Lx/Ly (mm)	OE broj	RAPIDEX broj
8.	190E24-43, 240E38, 260E24-43, 440E31-43, 190S27-50, 260S27-43, 440S43-56	7,5	90	2 x 29	950/945	41213060	VESA0317

IVECO (prednja osovina) EUROTRAKKER CURSOR, EUROTECH 2, STRALIS

Poz.	Tip vozila	Opterećenje (t)	Širina (mm)	Broj listova x debljina lista (mm)	Dužina Lx/Ly (mm)	OE broj	RAPIDEX broj
9.	180E24-27, 190E24-44, 260E30-44, 330E34-37, 380E31-47, 400E31-44, 440E37-44, 260S48-54, 440S40-54	8,0	90	1 x 25 2 x 26	950/950	8161628	VESA0318

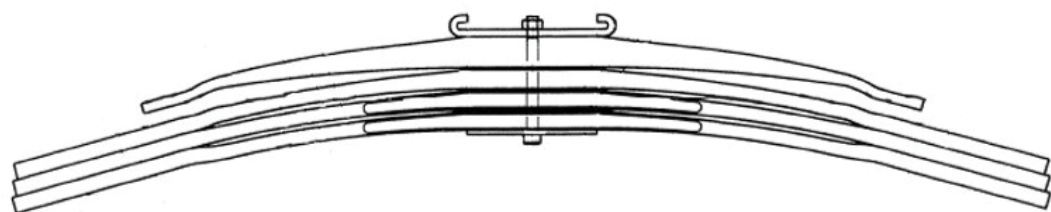
IVECO (zadnja osovina) EUROTRAKKER CURSOR

Poz.	Tip vozila	Opterećenje (t)	Širina (mm)	Broj listova x debljina lista (mm)	Dužina Lx/Ly (mm)	OE broj	RAPIDEX broj
10.	330E35-36, MP330E34H-37H, MP720E37HT-42HT	10,5	100	3 x 26 1 x 43 1 x 10	730/730	42126923	VESA0319

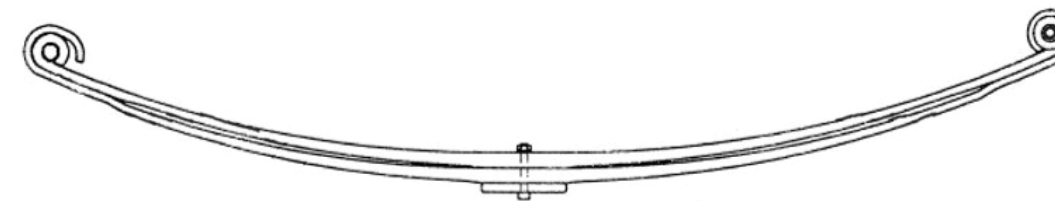
MAN (prednja osovina)

Poz.	Tip vozila	Opterećenje (t)	Širina (mm)	Broj listova x debljina lista (mm)	Dužina Lx/Ly (mm)	OE broj	RAPIDEX broj
1.	M90 08/88-06/96	-	80	2 x 25	800/900	81.43400.6456	VESA0320
2.	M90 08/88-06/96	-	80	2 x 25	850/850	81.43400.6368	VESA0321
3.	M90 08/88-06/96	-	80	3 x 25	900/900	81.43400.6409	VESA0322
4.	M90 08/88-06/96	7,1	80	3 x 26	900/900	81.43402.6021	VESA0323

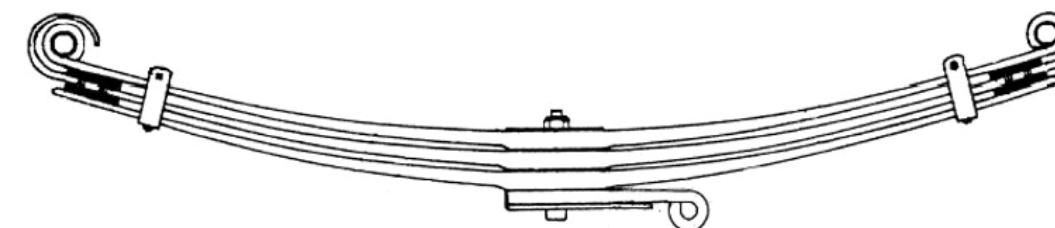
MAN (prednja osovina)

Poz.	Tip vozila	Opterećenje (t)	Širina (mm)	Broj listova x debljina lista (mm)	Dužina Lx/Ly (mm)	OE broj	RAPIDEX broj
5.	F90 05/88-06/96	7,1	90	3 x 23 1 x 18	900/900	81.43402.6013	VESA0324
6.	F90 05/88-06/96	8,0	90	3 x 25 1 x 18	900/900	81.43402.6014	VESA0325
7.	F90 05/88-06/96	7,5	90	4 x 23 1 x 18	900/900	81.43400.6412	VESA0326

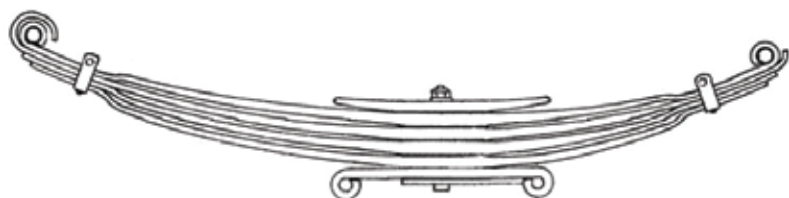

MAN (prednja osovina)

Poz.	Tip vozila	Opterećenje (t)	Širina (mm)	Broj listova x debljina lista (mm)	Dužina Lx/Ly (mm)	OE broj	RAPIDEX broj
8.	F90 05/88-06/96	8,0	90	4 x 23 1 x 18 1 x 21	900/700	81.43402.6006	VESA0327
9.	F90 05/88-06/96	9,0	90	4 x 24 1 x 18 1 x 21	900/700	81.43402.6009	VESA0328

MAN (zadnja osovina)

Poz.	Tip vozila	Opterećenje (t)	Širina (mm)	Broj listova x debljina lista (mm)	Dužina Lx/Ly (mm)	OE broj	RAPIDEX broj
10.	F90 05/88-06/96	10,0	100	2 x 33 1 x 46	840/840	81.43400.6879	VESA0329

MAN (zadnja osovina)

Poz.	Tip vozila	Opterećenje (t)	Širina (mm)	Broj listova x debljina lista (mm)	Dužina Lx/Ly (mm)	OE broj	RAPIDEX broj
11.	F90 05/88-06/96	13,0	100	1 x 26 1 x 19 4 x 18 5 x 23	825/825	81.43400.6867	VESA0330

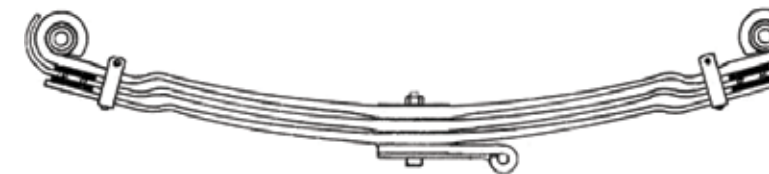
MAN (prednja osovina)

Poz.	Tip vozila	Opterećenje (t)	Širina (mm)	Broj listova x debljina lista (mm)	Dužina Lx/Ly (mm)	OE broj	RAPIDEX broj
12.	F2000	7,1	90	3 x 23 1 x 18	900/900	81.43402.6058	VESA0260

MAN (prednja osovina)



Poz.	Tip vozila	Opterećenje (t)	Širina (mm)	Broj listova x debljina lista (mm)	Dužina Lx/Ly (mm)	OE broj	RAPIDEX broj
13.	F2000	8,0	90	1 x 24 2 x 25 1 x 18 1 x 20	900/690	81.43402.6103	VESA0331

MAN (prednja osovina)

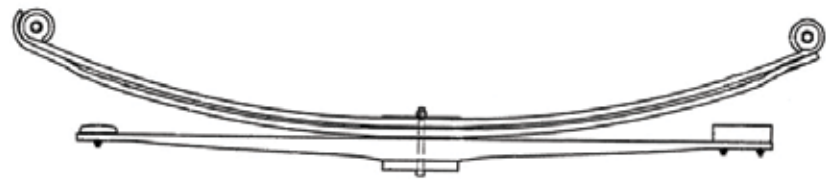

Poz.	Tip vozila	Opterećenje (t)	Širina (mm)	Broj listova x debljina lista (mm)	Dužina Lx/Ly (mm)	OE broj	RAPIDEX broj
14.	L2000 08/95→	3,2	80	2 x 20	825/825	81.43402.6050	VESA0332

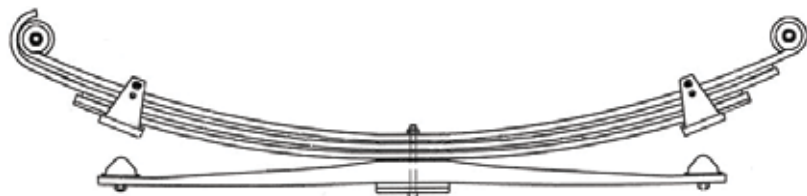
MAN (zadnja osovina)

Poz.	Tip vozila	Opterećenje (t)	Širina (mm)	Broj listova x debljina lista (mm)	Dužina Lx/Ly (mm)	OE broj	RAPIDEX broj
15.	L2000 08/95→	6,8	80	2 x 18 1 x 46 1 x 20	845/845	81.43402.6624	VESA0333

MAN (zadnja osovina)

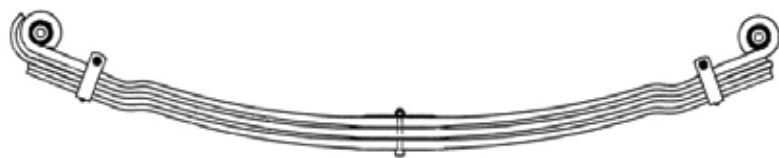
Poz.	Tip vozila	Opterećenje (t)	Širina (mm)	Broj listova x debljina lista (mm)	Dužina Lx/Ly (mm)	OE broj	RAPIDEX broj
16.	L2000 08/95→	6,8	80	1 x 13,5 1 x 12,6 1 x 13 1 x 45	800/800	81.43402.6538	VESA0334

MAN (prednja osovina)

Poz.	Tip vozila	Opterećenje (t)	Širina (mm)	Broj listova x debljina lista (mm)	Dužina Lx/Ly (mm)	OE broj	RAPIDEX broj
17.	M2000L, M2000M 08/95-12/05	7,1 - 7,5	90	3 x 23	875/875	81.43402.6207	VESA0335

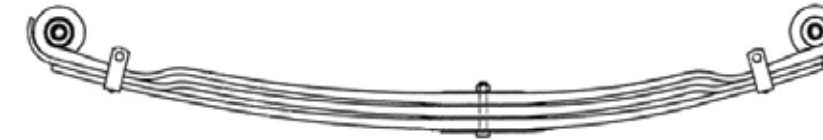
MAN TGA, TGS (prednja osovina)

Poz.	Tip vozila	Opterećenje (t)	Širina (mm)	Broj listova x debljina lista (mm)	Dužina Lx/Ly (mm)	OE broj	RAPIDEX broj
18.	32.310-35.480 02/04→	7,5	90	2 x 30	925/735	81.43402.6265	VESA0336
19.	18.410-18.510 26.310-26.530 33.360-40.480 02/04→	8,0	90	3 x 26	925/925	81.43402.6185	VESA0263
20.	32.310-35.480 01/02→ 35.530-41.530 07/06→ 41.350-41.530 12/04→	8,0	90	3 x 25	925/735	81.43402.6293	VESA0259
21.	32.310-35.530 09/02→ 41.410-41.530	8,0	90	1 x 24 3 x 23	925/735	81.43402.6200	VESA0337
22.	32.310-35.530 09/02→ 41.410-41.530	9,5	90	4 x 25	925/735	81.43402.6309	VESA0261

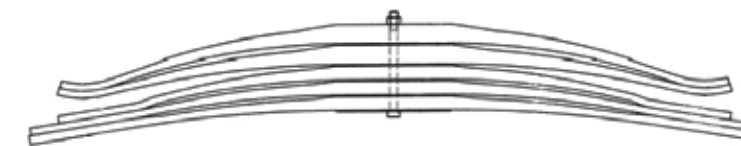
MAN TGA, TGS (zadnja osovina)

Poz.	Tip vozila	Opterećenje (t)	Širina (mm)	Broj listova x debljina lista (mm)	Dužina Lx/Ly (mm)	OE broj	RAPIDEX broj
23.	26.310-26.480, 32.310-35.480 40.410-40.480 05/04→	13,0	100	3 x 31 2 x 35	825/825	81.43402.6605	VESA0258
24.	F90 01/88-05/95, 18.360→, 26.310-26.530 10/00→, 33.410-33.530, 40.410-40.480 04/04→	16,0	100	3 x 31 2 x 42	825/825	81.43402.6681	VESA0338

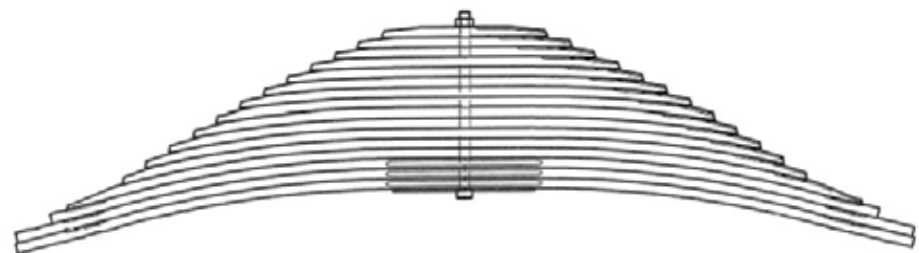
MAN TGA, TGS (zadnja osovina)

Poz.	Tip vozila	Opterećenje (t)	Širina (mm)	Broj listova x debljina lista (mm)	Dužina Lx/Ly (mm)	OE broj	RAPIDEX broj
25.	26.310-26.480, 32.310-35.480 40.410-40.480 05/04→	16,0	100	16 x 18	825/825	81.43402.6648	VESA0262

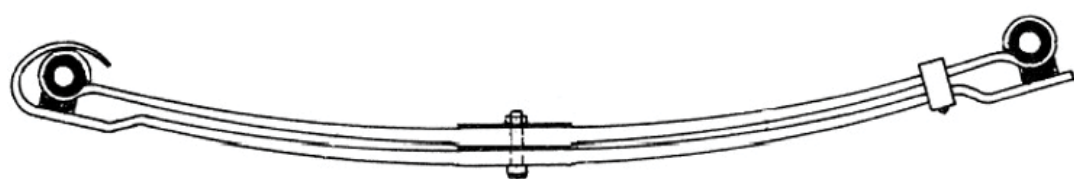
MERCEDES LK/LN2 (prednja osovina)

Poz.	Tip vozila	Opterećenje (t)	Širina (mm)	Broj listova x debljina lista (mm)	Dužina Lx/Ly (mm)	OE broj	RAPIDEX broj
1.	809K, 811K, 817, 914, 917, 1114, 1117 03/94-12/98	3,1	80	2 x 20	800/920	674 320 42 02	VESA0339
2.	814, 817, 914, 914K, 917, 917K 03/84-12/98	3,5	80	2 x 21	800/920	674 320 38 02	VESA0340
3.	809K, 811K, 814, 817, 914, 917, 1114-1120 03/84-12/98	3,8	80	3 x 18	800/920	675 320 48 02	VESA0341

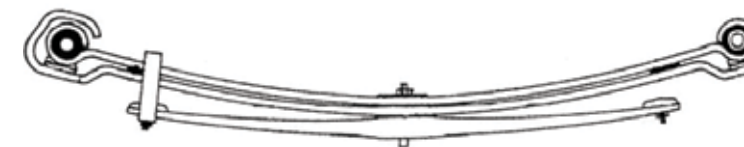
MERCEDES LK/LN2 (zadnja osovina)

Poz.	Tip vozila	Opterećenje (t)	Širina (mm)	Broj listova x debljina lista (mm)	Dužina Lx/Ly (mm)	OE broj	RAPIDEX broj
4.	809, 809K, 811, 811K, 814, 814K, 817, 817K, 917 03/94-12/98	4,9	80	2 x 14 1 x 34	790/790	673 320 21 06	VESA0342
5.	809, 811, 814, 817, 914, 917 03/94-12/98	6,2	80	1 x 16 1 x 15 1 x 36	790/790	674 320 35 06	VESA0343

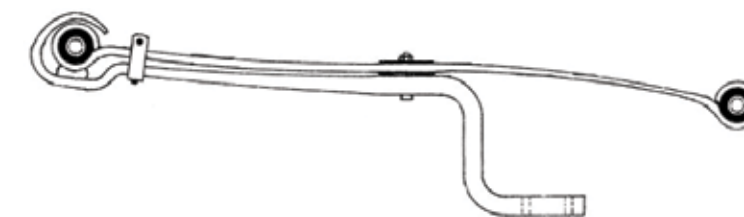
MERCEDES LK/LN2 (zadnja osovina)

Poz.	Tip vozila	Opterećenje (t)	Širina (mm)	Broj listova x debljina lista (mm)	Dužina Lx/Ly (mm)	OE broj	RAPIDEX broj
6.	814, 817L, 817LS	-	80	1 x 14 1 x 35	795/800	674 350 07 06	VESA0344
7.	1114, 1117, 1120, 1317, 1320, 1324, 1824	-	80	1 x 18 1 x 45	850/850	675 350 07 06	VESA0345



MERCEDES SPRINTER BM 903 (zadna osovina)



Poz.	Tip vozila	Opterećenje (t)	Širina (mm)	Broj listova x debljina lista (mm)	Dužina Lx/Ly (mm)	OE broj	RAPIDEX broj
8.	308, 310, 312, 314, 308CDI, 311CDI-316CDI 02/95-04/00	3,5	70	1 x 25	740/753	903 320 04 06	VESA0346
9.	314, 308CDI, 311CDI, 313CDI, 316CDI 04/00-05/06	-	70	1 x 19 1 x 20	740/753	903 320 19 06	VESA0347

MERCEDES ATEGO (prednja osovina)

Poz.	Tip vozila	Opterećenje (t)	Širina (mm)	Broj listova x debljina lista (mm)	Dužina Lx/Ly (mm)	OE broj	RAPIDEX broj
10.	714, 717, 812, 814, 815, 817, 822	3,2	80	1 x 29	860/940	970 320 14 02	VESA0348
11.	714, 717, 812, 814, 815, 817, 823	3,4	80	1 x 30	860/940	970 320 07 02	VESA0349

MERCEDES ACTROS, ATEGO, AXOR (zadnja osovina)

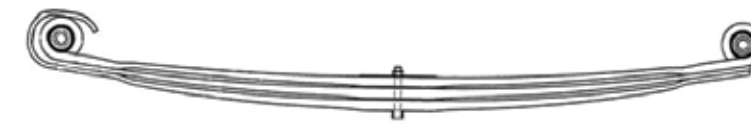

Poz.	Tip vozila	Opterećenje (t)	Širina (mm)	Broj listova x debljina lista (mm)	Dužina Lx/Ly (mm)	OE broj	RAPIDEX broj
12.	714, 717, 812, 814, 815, 817, 822 1517-1529	4,6	80	1 x 25 1 x 34	800/800	970 320 03 06	VESA0350
13.	714, 717, 812, 814, 815, 817, 823 1225, 1226	5,0	80	1 x 25 1 x 36	800/800	970 320 05 06	VESA0351

MERCEDES ACTROS, ATEGO, AXOR (prednja osovina)

Poz.	Tip vozila	Opterećenje (t)	Širina (mm)	Broj listova x debljina lista (mm)	Dužina Lx/Ly (mm)	OE broj	RAPIDEX broj
14.	1823-1853, 2528-2536, 2628-2657 04/96-10/02	7,1	90	1 x 22 2 x 23	900/900	943 320 02 02	VESA0352
15.	1831-1857, 2531-2553, 2631-2657 04/96-10/02	7,1	90	2 x 27	900/900	943 320 09 02	VESA0353
16.	1823-1853, 2031-2051, 2528-2536, 2628-2633 04/96-10/02	7,5	90	1 x 22 2 x 24	900/900	943 320 04 02	VESA0354
17.	1831-1855, 2531-2555, 2631-2655	7,1	90	2 x 27	900/900	000 320 01 02	VESA0274
18.	1831-1855, 2531-2555, 2631-2655	7,5	90	2 x 28	900/900	000 320 02 02	VESA0169
19.	1831-2031, 2635-2643, 3231-3343 04/96-10/02	8,0	90	1 x 22 2 x 25	900/900	943 320 03 02	VESA0277
20.	1828-1833, 2532-2555, 2628-2651, 3331-4144 04/96-10/02	8,0	90	1 x 24 2 x 25	900/900	943 320 05 02	VESA0355
21.	1831-1853, 2531-2648, 3240-3243, 4140-4148 09/96-10/02	7,5	90	1 x 23 2 x 25	780/800	949 320 03 02	VESA0356

MERCEDES ACTROS, ATEGO, AXOR (zadnja osovina)

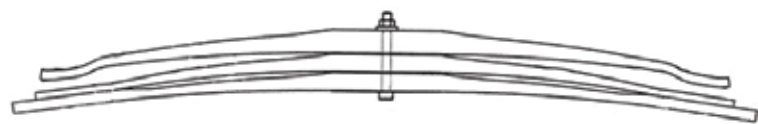
Poz.	Tip vozila	Opterećenje (t)	Širina (mm)	Broj listova x debljina lista (mm)	Dužina Lx/Ly (mm)	OE broj	RAPIDEX broj
22.	1831-1853, 2031-2640, 3240-3331 04/96-10/02	11,5	100	1 x 28 1 x 30 1 x 35	900/885	943 320 01 08	VESA0357

MERCEDES ACTROS, ATEGO, AXOR (zadnja osovina)

Poz.	Tip vozila	Opterećenje (t)	Širina (mm)	Broj listova x debljina lista (mm)	Dužina Lx/Ly (mm)	OE broj	RAPIDEX broj
23.	1831-2031, 2531-2631, 3240-4140 04/96-10/02	9,5	100	2 x 37 1 x 49	780/780	948 320 15 05	VESA0275
24.	2631-2658, 3231-3248 04/96-10/02	9,5	100	2 x 37 1 x 48	780/780	948 320 17 05	VESA0276
25.	1831-2031, 2531-2631, 3235-3340, 4140 04/96-10/02	15,0	100	4 x 37	780/780	948 320 10 05	VESA0358
26.	3331-3360, 4140-4151 04/96-10/02	16,0	100	5 x 37	780/780	948 320 11 05	VESA0359

MERCEDES ACTROS, ATEGO, AXOR (zadnja osovina)

Poz.	Tip vozila	Opterećenje (t)	Širina (mm)	Broj listova x debljina lista (mm)	Dužina Lx/Ly (mm)	OE broj	RAPIDEX broj
27.	1831-1855 04/96-10/02	13	100	1 x 23 4 x 25	900/750	944 320 02 08	VESA0273

RENAULT (prednja osovina)

Poz.	Tip vozila	Opterećenje (t)	Širina (mm)	Broj listova x debljina lista (mm)	Dužina Lx/Ly (mm)	OE broj	RAPIDEX broj
1.	Midliner-M	-	80	2 x 30	900/1060	5010167852	VESA0360

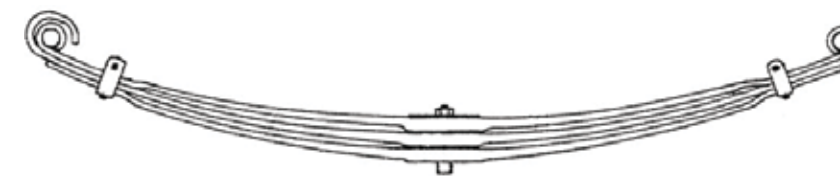
SCANIA (prednja osovina)

Poz.	Tip vozila	Opterećenje (t)	Širina (mm)	Broj listova x debljina lista (mm)	Dužina Lx/Ly (mm)	OE broj	RAPIDEX broj
1.	Seriya 3, Seriya 4	7,5	90	2 x 32	910/910	353174	VESA0266
2.	Seriya 3, Seriya 4	8,5	90	3 x 29	910/910	1 300 566	VESA0264

SCANIA (zadnja osovina)

Poz.	Tip vozila	Opterećenje (t)	Širina (mm)	Broj listova x debljina lista (mm)	Dužina Lx/Ly (mm)	OE broj	RAPIDEX broj
3.	Seriya 3, Seriya 4	-	100	1 x 47 1 x 44	707/410	1 421 061	VESA0265
4.	Seriya 3, Seriya 4	-	100	1 x 47 1 x 44	707/410	1 421 060	VESA0267

SCANIA (zadnja osovina)

Poz.	Tip vozila	Opterećenje (t)	Širina (mm)	Broj listova x debljina lista (mm)	Dužina Lx/Ly (mm)	OE broj	RAPIDEX broj
5.	Seriya 4, 94, 124, 144	26,3	90	10 x 25	795/795	1 398 987	VESA0268



VOLVO (prednja osovina)

Poz.	Tip vozila	Opterećenje (t)	Širina (mm)	Broj listova x debljina lista (mm)	Dužina Lx/Ly (mm)	OE broj	RAPIDEX broj
1.	FH12, FM12	-	100	1 x 28 1 x 30	990/900	257854	VESA0361
2.	FH12, FH16, FM7, FM10, FM12 (4 x 2, 6 x 2, 6 x 4)	7,1	100	2 x 30	990/900	257840	VESA0270
3.	FH12, FH16, FM7, FM10, FM12 (4 x 2, 6 x 2, 6 x 4)	7,1	100	2 x 30	990/900	257867	VESA0362

VOLVO (prednja osovina)

Poz.	Tip vozila	Opterećenje (t)	Širina (mm)	Broj listova x debljina lista (mm)	Dužina Lx/Ly (mm)	OE broj	RAPIDEX broj
4.	FH12, FH16, FM7, FM10, FM12	8,0	100	2 x 32	990/900	257857	VESA0272
5.	FH12, FH16, FM7, FM10, FM12 (8 x 2, 8 x 4)	6,5-8,0	100	2 x 32	990/900	257860	VESA0271
6.	FH12, FH16, FM7, FM10, FM12 (8 x 2, 8 x 4)	6,5-8,0	100	1 x 22 2 x 24	795/795	257868	VESA0269
7.	FH12, FM12	8,0	100	2 x 32	990/900	257927	VESA0305
8.	FH12, FM12	-	100	1 x 22 2 x 24	795/795	257928	VESA0306

VOLVO (zadnja osovina)

Poz.	Tip vozila	Opterećenje (t)	Širina (mm)	Broj listova x debljina lista (mm)	Dužina Lx/Ly (mm)	OE broj	RAPIDEX broj
9.	FH12, FH16, FM7, FM10, FM12	2 x 10,5	75	2 x 43 1 x 55	815/815	257871	VESA0363

VOLVO (zadnja osovina)



Poz.	Tip vozila	Opterećenje (t)	Širina (mm)	Broj listova x debljina lista (mm)	Dužina Lx/Ly (mm)	OE broj	RAPIDEX broj
10.	F, FL, N, NL	13,0	100	3 x 32	895/820	257428	VESA0364

BPW



Poz.	Tip osovine	Opterećenje (t)	Širina (mm)	Broj listova x debljina lista (mm)	Dužina Lx/Ly (mm)	OE broj	RAPIDEX broj
1.	BPW	-	100	1 x 48	578/295	05.082.12.92.0	VESA0365
2.	BPW	-	100	1 x 48	575/365	05.082.13.71.0	VESA0366
3.	BPW	-	100	1 x 51	578/295	05.082.13.48.0	VESA0367
4.	BPW	-	100	1 x 51	575/365	05.082.13.18.0	VESA0368

BPW

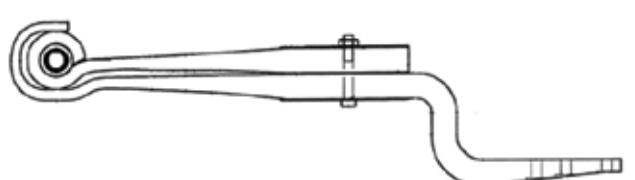

Poz.	Tip osovine	Opterećenje (t)	Širina (mm)	Broj listova x debljina lista (mm)	Dužina Lx/Ly (mm)	OE broj	RAPIDEX broj
5.	BPW	10,0	100	1 x 48	575/295	05.082.13.51.0	VESA0369
6.	BPW	10,0	100	1 x 48	575/365	05.082.12.93.0	VESA0280

BPW							
							
Poz.	Tip osovine	Opterećenje (t)	Širina (mm)	Broj listova x debljina lista (mm)	Dužina Lx/Ly (mm)	OE broj	RAPIDEX broj
7.	BPW	-	100	2 x 33	500/395	05.082.12.27.0	VESA0370
8.	BPW	-	100	2 x 33	550/395	05.082.02.74.0	VESA0371
9.	BPW	-	100	2 x 38	500/440	05.082.12.67.0	VESA0372
10.	BPW	-	100	2 x 40	550/395	05.082.02.99.0	VESA0373

BPW							
							
Poz.	Tip osovine	Opterećenje (t)	Širina (mm)	Broj listova x debljina lista (mm)	Dužina Lx/Ly (mm)	OE broj	RAPIDEX broj
11.	BPW	-	100	2 x 40	550/465	05.082.12.84.0	VESA0374
12.	BPW	-	100	2 x 43	500/465	05.082.13.33.0	VESA0375

BPW							
							
Poz.	Tip osovine	Opterećenje (t)	Širina (mm)	Broj listova x debljina lista (mm)	Dužina Lx/Ly (mm)	OE broj	RAPIDEX broj
13.	BPW	-	100	3 x 19	510/510	05.082.04.12.1	VESA0376
14.	BPW	-	100	3 x 19	610/610	05.082.03.32.0	VESA0282

BPW							
							
Poz.	Tip osovine	Opterećenje (t)	Širina (mm)	Broj listova x debljina lista (mm)	Dužina Lx/Ly (mm)	OE broj	RAPIDEX broj
15.	BPW	10,0	100	3 x 22	595/595	05.082.04.30.0	VESA0377

BPW							
							
Poz.	Tip osovine	Opterećenje (t)	Širina (mm)	Broj listova x debljina lista (mm)	Dužina Lx/Ly (mm)	OE broj	RAPIDEX broj
16.	BPW	8,0	100	3 x 21	515/515	05.082.03.48.0	VESA0378
17.	BPW	8,0	100	3 x 21	550/550	05.082.03.58.0	VESA0379
18.	BPW	8,0	100	4 x 15,5	503/503	05.082.03.57.0	VESA0380

GIGANT							
							
Poz.	Tip osovine	Opterećenje (t)	Širina (mm)	Broj listova x debljina lista (mm)	Dužina Lx/Ly (mm)	OE broj	RAPIDEX broj
1.	GIGANT	9,0	100	3 x 22	615/700	919013	VESA0381

GIGANT



Poz.	Tip osovine	Opterećenje (t)	Širina (mm)	Broj listova x debljina lista (mm)	Dužina Lx/Ly (mm)	OE broj	RAPIDEX broj
2.	GIGANT	10,0	100	3 x 20	565/592	419033	VESA0382

KÄSSBOHRER

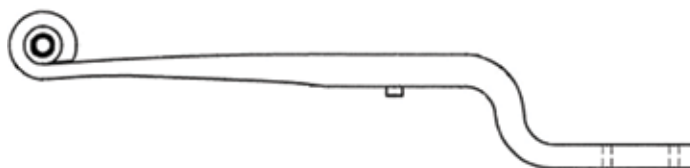
Poz.	Tip osovine	Opterećenje (t)	Širina (mm)	Broj listova x debljina lista (mm)	Dužina Lx/Ly (mm)	OE broj	RAPIDEX broj
1.	KÄSSBOHRER	9,0	80	2 x 40	550/340	8231224000C	VESA0383

ROR

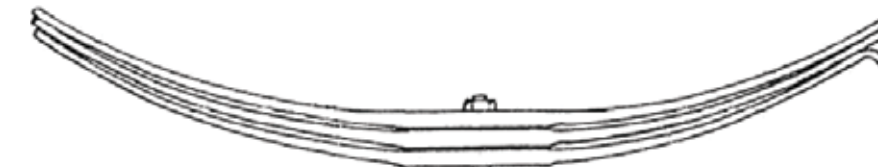
Poz.	Tip osovine	Opterećenje (t)	Širina (mm)	Broj listova x debljina lista (mm)	Dužina Lx/Ly (mm)	OE broj	RAPIDEX broj
1.	ROR	9,0	100	1 x 48	530/450	21222247	VESA0384

ROR

Poz.	Tip osovine	Opterećenje (t)	Širina (mm)	Broj listova x debljina lista (mm)	Dužina Lx/Ly (mm)	OE broj	RAPIDEX broj
2.	ROR	10,0	75	3 x 25	645/614	21204279	VESA0385

ROR

Poz.	Tip osovine	Opterećenje (t)	Širina (mm)	Broj listova x debljina lista (mm)	Dužina Lx/Ly (mm)	OE broj	RAPIDEX broj
3.	ROR	10,0	75	1 x 43	572/572	21200891	VESA0386

SAF

Poz.	Tip osovine	Opterećenje (t)	Širina (mm)	Broj listova x debljina lista (mm)	Dužina Lx/Ly (mm)	OE broj	RAPIDEX broj
1.	SAF	-	100	1 x 48	517/425	3.149.0045.02	VESA0387
2.	SAF	-	100	1 x 48	520/375	3.155.1028.02	VESA0388

SAF

Poz.	Tip osovine	Opterećenje (t)	Širina (mm)	Broj listova x debljina lista (mm)	Dužina Lx/Ly (mm)	OE broj	RAPIDEX broj
3.	SAF	-	100	2 x 33	520/365	3.155.1014.01	VESA0389
4.	SAF	-	100	2 x 38	520/365	3.155.1025.01	VESA0390

SAF



Poz.	Tip osovine	Opterećenje (t)	Širina (mm)	Broj listova x debljina lista (mm)	Dužina Lx/Ly (mm)	OE broj	RAPIDEX broj
5.	SAF	-	100	2 x 38	520/365	3.155.1025.02	VESA0391

TRAILOR

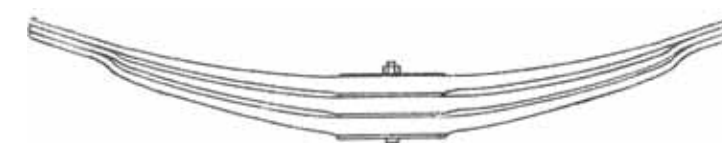

Poz.	Tip osovine	Opterećenje (t)	Širina (mm)	Broj listova x debljina lista (mm)	Dužina Lx/Ly (mm)	OE broj	RAPIDEX broj
1.	TRAILOR	-	100	2 x 33	520/365	6505240P	VESA0392

TRAILOR

Poz.	Tip osovine	Opterećenje (t)	Širina (mm)	Broj listova x debljina lista (mm)	Dužina Lx/Ly (mm)	OE broj	RAPIDEX broj
2.	TRAILOR	-	100	2 x 40	520/410	6505563P	VESA0393

TRAILOR

Poz.	Tip osovine	Opterećenje (t)	Širina (mm)	Broj listova x debljina lista (mm)	Dužina Lx/Ly (mm)	OE broj	RAPIDEX broj
3.	TRAILOR	-	90	3 x 21	570/570	6504765S	VESA0394



DAF						
Slika	Poz.	Tip vozila	Dimenzije d / D / h (mm)	SE-M broj	OE broj	RAPIDEX broj
	1.	65CF, 75CF, 85CF, 95XF, XF95	24 / 62,5 / 86	8755	1357764	VESA1020

IVECO						
Slika	Poz.	Tip vozila	Dimenzije d / D / h (mm)	SE-M broj	OE broj	RAPIDEX broj
	1.	Eurocargo 130E18, 150E15-27, Tector 130E18-24, 150E18-28	20 / 57 / 84	8291	98413939	VESA1021
	2.	Eurocargo 65E12H, 75E13-18, Tector 75E13-18	16 / 47 / 74	-	98413847	VESA1022
	3.	Eurocargo 65E12H, 75E13-18, Tector 75E13-18	16,5 / 45,5 / 40	-	98482540	VESA1023
	4.	Eurotrakker 340E34-37, 410E42, Stralis 190E24-43, 240E38, 260E24-43, 440E31-43, Stralis 190S27-50, 260S27-43, 440S43-56	20,3 / 62 / 97	8190	8160686	VESA1024
	5.	Eurotrakker 340E34-37, 410E42, Stralis 190E24-43, 240E38, 260E24-43, 440E31-43, Stralis 190S27-50, 260S27-43, 440S43-56	20 / 60 / 87	-	8138899	VESA1025

MAN						
Slika	Poz.	Tip vozila	Dimenzije d / D / h (mm)	SE-M broj	OE broj	RAPIDEX broj
	1.	M90 08/88-06/96	25 / 30 / 78	-	81.41304.0043	VESA1026
	2.	M90 08/88-06/96, L2000 08/95→	16 / 50 / 95	7725	81.96020.0231	VESA1027
	3.	F90 05/88-06/96	30 / 36 / 87	-	81.41304.0044	VESA0570
	4.	F90 05/88-06/96	44 / 48 / 95	-	81.41304.0050	VESA0584
	5.	F2000	24 / 70 / 95	1015	81.43722.0061	VESA1028
	6.	M2000L, M2000M 08/95-12/05	20 / 57 / 84	7856	81.43722.0051	VESA0243
	7.	TGA, TGS 32.310-35.480 01/02→, 35.530-41.530 07/06→, 41.350-41530 12/04→	24 / 65 / 95	7920	81.43722.0070	VESA0636

MERCEDES						
Slika	Poz.	Tip vozila	Dimenzije d / D / h (mm)	SE-M broj	OE broj	RAPIDEX broj
	1.	809K, 811K, 817, 914, 917, 1114, 1117 03/94-12/98	16 / 46 / 96	7589	673 320 00 50	VESA0470
	2.	814, 817, 914, 914K, 917, 917K 03/84-12/98	36 / 58 / 96	7581	673 320 01 50	VESA0731
	3.	814, 817, 914, 914K, 917, 917K 03/84-12/98	36 / 48 / 58	8236	673 320 02 50	VESA1029
	4.	1114, 1117, 1120, 1317, 1320, 1324, 1824	36 / 64 / 96	-	675 320 01 50	VESA1030
	5.	NG, SK Set za popravku osovinnice gibnja	25 / 140	-	395 320 02 65	VESA0615
	6.	NG, SK Set za popravku osovinnice gibnja	30 / 148	-	389 320 00 65	VESA1031
	7.	Sprinter 308, 310, 312, 314, 308CDI, 311CDI-316CDI 02/95-04/00	12 / 49 / 80	7821	901 324 03 50	VESA1032

MERCEDES						
Slika	Poz.	Tip vozila	Dimenzije d / D / h (mm)	SE-M broj	OE broj	RAPIDEX broj
	8.	Atego 714, 717, 812, 814, 815, 817, 822	16 / 50 / 96	-	970 320 00 44	VESA1033
	9.	Atego 714, 717, 812, 814, 815, 817, 822, 1517-1529	18 / 50 / 96	7897	970 320 01 44	VESA1034
	10.	Actros 1823-1853, 2528-2536, 2628-2657 04/96-10/02	24 / 62 / 96	8016	000 322 32 85	VESA1035
	11.	Actros 1831-1855 04/96-10/02, Atego 1823-2628	24 / 62 / 106	1007	000 325 07 85	VESA1036
	12.	1831-2031, 2531-2631, 3235-3340, 4140 04/96-10/02	A-232, B-165, h-152	8030	000 325 07 96	VESA0461

SCANIA						
Slika	Poz.	Tip vozila	Dimenzije d / D / h (mm)	SE-M broj	OE broj	RAPIDEX broj
	1.	Seriya 3, Seriya 4	M28 x 4 / 36 / 90	8266	128680	VESA1037
	2.	Seriya 3, Seriya 4	M28 x 4 / 166,5	8265	128681	VESA1038

VOLVO						
Slika	Poz.	Tip vozila	Dimenzije d / D / h (mm)	SE-M broj	OE broj	RAPIDEX broj
	1.	FH12, FH16, FM7, FM10, FM12 (4x2, 6x2, 6x4)	M33 x 4 / 170	-	1075723	VESA1039
	2.	FH12, FH16, FM7, FM10, FM12 (4x2, 6x2, 6x4)	M33 x 4 / 45 / 105	-	1075726	VESA1040
	3.	F, FL, N, NL	M24 x 3 / M44 x 3 / 112	-	1608019	VESA1041







BPW						
Slika	Poz.	Tip vozila	Dimenzije d / D / h (mm)	SE-M broj	OE broj	RAPIDEX broj
	1.	OT, SLM, SLO, SLU, O, OM	20 / 57 / 102	7781	02.0316.90.00	VESA1042
	2.	VH, VO	30 / 59,5 / 102	7971	02.0316.06.00	VESA0463
	3.	VA	50 / 100 / 130	7972	02.0316.65.00	VESA1043

BPW						
Slika	Poz.	Tip vozila	Dimenzije d / D / h (mm)	SE-M broj	OE broj	RAPIDEX broj
	4.	VA	30 / 52,5 / 68	7974	05.113.96.06.0	VESA1044
	5.	VO, VH, VA	24 / 50 / 68	7975	05.113.90.06.0	VESA1045
	6.	VB	60 / 105 / 146	7978	05.113.97.10.0	VESA1046

SAF						
Slika	Poz.	Tip vozila	Dimenzije d / D / h (mm)	SE-M broj	OE broj	RAPIDEX broj
	1.	SAF	30 / 68 / 104	7787	4.177.3010.00	VESA1047

IVECO							
Slika	Pozicija	Tip vozila	Mesto ugradnje	Dimenzije d x D x h (mm)	SE-M broj	OE broj	RAPIDEX broj
	1.	Euro Tech MP 11/99→	ZO	62 x 94 x 70/80	8119	008169892	VESA1013

MAN							
Slika	Pozicija	Tip vozila	Mesto ugradnje	Dimenzije d x D x h (mm)	SE-M broj	OE broj	RAPIDEX broj
	1.	G90 09/87-10/93	ZO	14 x 37.5 x 51	7704	81.96020.0286	VESA0469
	2.	G90 09/87-10/93	ZO	32 x 56 x 51	8528	81.43704.0052	VESA0501
	3.	L2000 09/00→	PO	39 x 56 x 60	7723	81.43722.0053	VESA0468
	4.	G90 09/87-10/93	PO	- x 27 x 50.5	8212	81.96210.0278	VESA0502
	5.	M90 08/88-06/96	PO	16 x 45 x 42	7436	81.43271.0029	VESA0819

MAN							
Slika	Pozicija	Tip vozila	Mesto ugradnje	Dimenzije d x D x h (mm)	SE-M broj	OE broj	RAPIDEX broj
	6.	F90, G90 09/87-10/93, F2000 01/94→	PO	16 x 45 x 47	7529	81.43722.0022	VESA0812
	7.	F90 04/89-06/96	ZO	22 x 75 x 62	7527	81.43722.0019	VESA0565
	8.	F90 04/89-12/90, M90 05/90-06/96	ZO	22 x 65 x 62	7528	81.43722.0021	VESA0813
	9.	F2000 01/94-12/95, M2000 08/95-12/05	ZO	22 x 67 x 62	7622	81.43722.0039	VESA0807
	10.	F90 02/90-06/96	PO	24 x 64 x 44	7673	81.43722.0047	VESA0804
	11.	F2000 01/94-12/95, M2000 08/95-12/05	ZO	22 x 68 x 62	7689	81.43722.0063	VESA0591
	12.	F90, G90 09/87-10/93, F2000 01/94→	PO	16 x 47 x 47	7545	81.96210.0450	VESA0809

MAN							
Slika	Pozicija	Tip vozila	Mesto ugradnje	Dimenzije d x D x h (mm)	SE-M broj	OE broj	RAPIDEX broj
	13.	TGA, TGX, TGS	PO	16 x 50 x 47	7702	81.43722.0059	VESA0121
	14.	F90 04/89-06/96	PO	44 x 47 x 60	7502	81.43704.0067	VESA0818
	15.	F90 02/90-06/96, F2000 01/94-12/98	ZO	60 x 78 x 60	7503	81.43704.0061	VESA0817
	16.	F90 04/90-06/96	ZO	56 x 93 x 70	7504	81.43271.0081	VESA0816
	17.	F90 04/89-06/96	ZO	55 x 77 x 60	7532	81.43704.0060	VESA0598
	18.	M2000	PO	45 x 64 x 51	7808	81.43704.0074	VESA0590
	19.	TGA, TGS	PO	43 x 76 x 50	8015	81.43704.0079	VESA0630

MAN							
Slika	Pozicija	Tip vozila	Mesto ugradnje	Dimenzije d x D x h (mm)	SE-M broj	OE broj	RAPIDEX broj
	20.	TGA, TGS	PO	46 x 76 x 50	7953	81.43704.0078	VESA0633
	21.	TGA, TGS	ZO	52 x 76 x 50	7865	81.43704.0077	VESA0799
	22.	F2000, M2000, TGA, TGS	ZO	55 x 82 x 70	7620	81.43722.0040	VESA0808
	23.	F90 02/90-06/96	ZO	55 x 80 x 80	7573	81.43704.0025	VESA0500
	24.	G90, L2000, M2000, M90	PO	46 x 71 x 80	7574	81.43704.0029	VESA0597
	25.	F90 02/90-06/96	ZO	39 x 66 x 75	7575	81.43704.0026	VESA0596
	26.	F90 02/90-06/96	ZO	60 x 85 x 80	8032	81.43704.0032	VESA0595

MAN							
Slika	Pozicija	Tip vozila	Mesto ugradnje	Dimenzije d x D x h (mm)	SE-M broj	OE broj	RAPIDEX broj
	27.	M90 08/88-06/96	ZO	19 x 65 x 130	7526	81.43271.0087	VESA0599
	28.	F90, M90, F2000	ZO	15 x 65 x 100	7603	81.43271.0080	VESA0728
	29.	F90 02/90-06/96	ZO	21 x 47 x 101	7837	81.96210.0511	VESA0122
	30.	S2000	-	15 x 67 x 80	7709	81.43220.6177	VESA0124
	31.	S2000	-	- x 67 x 83	7708	81.43220.6177	VESA0123

MERCEDES							
Slika	Pozicija	Tip vozila	Mesto ugradnje	Dimenzije d x D x h (mm)	SE-M broj	OE broj	RAPIDEX broj
	1.	LK 01/84-12/98, VARIO 512-815 09/96→, ATEGO 01/98-10/04, ATEGO 2 10/04→	ZO	17 x 38 x 38	8241	318 320 00 73	VESA0506

MERCEDES							
Slika	Pozicija	Tip vozila	Mesto ugradnje	Dimenzije d x D x h (mm)	SE-M broj	OE broj	RAPIDEX broj
	2.	ACTROS 04/96-10/02, AXOR 2 10/04→, ATEGO 05/98-09/04, ACTROS MP2	ZO	58 x 82 x 56	7931	000 326 44 81	VESA0191
	3.	ACTROS 04/96-10/02, AXOR 2 10/04→, ATEGO 05/98-09/04, ACTROS MP2, AXOR 01/02-10/04, MK, SK 09/89-09/96	PO	38.5 x 61 x 56	7729	000 326 24 81	VESA0467
	4.	ACTROS 04/96-10/02, AXOR 2 10/04→ ATEGO 05/98-09/04	PO/ ZO	40 x 65 x 45	8040	941 326 03 50	VESA0735
	5.	ACTROS 04/96-10/02, AXOR 2 10/04→, ATEGO 05/98-09/04, ACTROS MP2, AXOR 01/02-10/04, ECONIC 01/98→	ZO	40 x 70 x 36.5/46	7862	000 323 79 85	VESA0103
	6.	ACTROS 04/96-10/02, AXOR 2 10/04→, ATEGO 05/98-09/04, ACTROS MP2, AXOR 01/02-10/04, ECONIC 01/98→	ZO	40 x 80 x 46	7965	000 323 81 85	VESA0724
	7.	ACTROS 04/96-10/02, AXOR 2 10/04→, ATEGO 05/98-09/04, ACTROS MP2, AXOR 01/02-10/04, ECONIC 01/98→	ZO	82 x 110 x 65	7861	941 326 00 50	VESA0464

MERCEDES							
Slika	Pozicija	Tip vozila	Mesto ugradnje	Dimenzije d x D x h (mm)	SE-M broj	OE broj	RAPIDEX broj
	8.	LK/LN2 01/84-12/98	PO	28 x - x 60	8073	673 323 03 85	VESA1015
	9.	LK/LN2 01/84-12/98	PO	35 x - x 60	8096	673 323 06 85	VESA1014
	10.	LK/LN2 01/84-12/98	ZO	45 x - x 60	8765	675 326 06 81	VESA1016
	11.	LK/LN2 01/84-12/98	ZO	40 x 67 x 60	8766	675 326 04 81	VESA0499
	12.	LK/LN2 01/84-12/98	ZO	39 x 58 x 47	8089	673 326 06 81	VESA0823
	13.	MK, NG, SK 09/89-09/96	ZO	32 x 60 x 52	8803	000 326 23 81	VESA1017
	14.	MK, NG, SK 09/89-09/96	ZO	48 x 71.5 x 41	8335	655 323 00 85	VESA0031



MERCEDES							
Slika	Pozicija	Tip vozila	Mesto ugradnje	Dimenzije d x D x h (mm)	SE-M broj	OE broj	RAPIDEX broj
	15.	MK, NG, SK 09/89-09/96	PO	70 x 98 x 67	7963	941 323 01 50	VESA1018
	16.	MK, SK 09/89-09/96	ZO	65 x 111 x 65	7676	652 326 03 81	VESA1019
	17.	MK, NG 05/82-09/96	PO	30 x 55 x 20	8494	000 981 61 31	KABI0336

MERCEDES - SET STABILIZATORA			
Slika	Tip vozila / Opis	SE-M / OE broj	RAPIDEX broj
	LK, NG, SK 09/89-09/96 Prednja osovina	7788 621 320 04 28	VESA0446
	NG, SK 09/89-09/96 Zadnja osovina	7789 625 320 01 11	VESA0445

MERCEDES - SET STABILIZATORA			
Slika	Tip vozila / Opis	SE-M / OE broj	RAPIDEX broj
	NG, SK 09/89-09/96 Prednja osovina	7845 620 320 06 28	VESA0444
	NG, SK 09/89-09/96 Zadnja osovina	7924 621 320 00 11	VESA0442
	NG, SK 09/89-09/96 Zadnja osovina	7925 620 320 01 11	VESA0443
	NG, SK 09/89-09/96 Zadnja osovina	7927 387 320 03 28	VESA0635



MERCEDES - SET STABILIZATORA			
Slika	Tip vozila / Opis	SE-M / OE broj	RAPIDEX broj
	ACTROS 04/96-10/02, AXOR 2 10/04→, ATEGO 05/98-09/04, ACTROS MP2, AXOR 01/02-10/04, ECONIC 01/98→ Prednja i zadnja osovina	8000 000 3237985S-1	VESA0631
	ACTROS 04/96-10/02, AXOR 2 10/04→, ATEGO 05/98-09/04, ACTROS MP2, AXOR 01/02-10/04, ECONIC 01/98→ Prednja i zadnja osovina	7999 000 3237985S-2	VESA0632
	ACTROS 04/96-10/02, AXOR 2 10/04→, ATEGO 05/98-09/04, ACTROS MP2, AXOR 01/02-10/04, ECONIC 01/98→ Prednja i zadnja osovina	7998 000 3237985S-3	VESA0462





SCANIA							
Slika	Pozicija	Tip vozila	Mesto ugradnje	Dimenzije d x D x h (mm)	SE-M broj	OE broj	RAPIDEX broj
	1.	Seriya 4 08/96→	PO	65 x 103 x 103.5	8760	1 344 190	VESA0997
	2.	Seriya 4 08/96→	PO/ ZO	50 x 71 x 103	8011	0 228 483	VESA0998
	3.	Seriya 4 08/96→	PO	40 x 56 x 122	8012	0 213 604	VESA0999

VOLVO							
Slika	Pozicija	Tip vozila	Mesto ugradnje	Dimenzije d x D x h (mm)	SE-M broj	OE broj	RAPIDEX broj
	1.	FL6, FL7, FL10, FL12, FH12, FH16, FM7, FM9, FM10, FM12	ZO	34 x 65 x 64	7692	1620750	VESA1000
	2.	FL7, FL10, FL12, FH12, FH16	PO	17 x 45 x 50	7785	1624605	VESA1001
	3.	FL6, FL7, FL10, FL12, FH12, FH16, FM7, FM9, FM10, FM12	PO/ ZO	28 x 57.5 x 64	7822	1134955	VESA1002

VOLVO							
Slika	Pozicija	Tip vozila	Mesto ugradnje	Dimenzije d x D x h (mm)	SE-M broj	OE broj	RAPIDEX broj
	4.	FL7, FL10, FL12	PO/ ZO	59 x 90 x 95	8595	9519245	VESA1003
	5.	FL7, FL10, FL12, FH12, FH16	ZO	65 x 116 x 95	8596	1079256	VESA1004
	6.	FM7, FM9, FM10, FH12, FH16	ZO	72 x 116 x 95	8597	1077594	VESA1005
	7.	FL6, FL7, FL10, FL12, FH12	ZO	64 x 90 x 96	8111	1607561	VESA1006
	8.	FL6, FL7, FL10, FL12, FH12, FH16, FM7, FM9, FM10, FM12	ZO	54 x 72 x 96	8039	1605182	VESA1007
	9.	FL7, FL10, FL12, FH12	ZO	75 x 115 x 95	8109	1622838	VESA1008

VOLVO							
Slika	Pozicija	Tip vozila	Mesto ugradnje	Dimenzije d x D x h (mm)	SE-M broj	OE broj	RAPIDEX broj
	10.	FM7, FM9, FM10, FM12, FH12, FH16	PO	35 x 56.5 x 89	8107	1075179	VESA1009
	11.	FM7, FM9, FM10, FM12, FH12, FH16	PO	44 x 61 x 87.5	8108	1075180	VESA1010
	12.	FM7, FM10, FM12, FH12, FH16	PO	40 x 66 x 90	8598	1076890	VESA1011

NEOPLAN							
Slika	Pozicija	Tip vozila	Mesto ugradnje	Dimenzije d x D x h (mm)	SE-M broj	OE broj	RAPIDEX broj
	1.	Neoplan	PO	36 x 64 x 76	7645	0801.550.38	VESA0011
	2.	Neoplan	PO	32 x 60 x 66	7657	0801.550.37	VESA0996
	3.	Neoplan	PO	19 x 64 x 124	7632	0801.550.19	VESA0012

DELOVI RUKAVACA				
Slika	Poz.	Tip vozila	OE broj	RAPIDEX broj
	1.	DAF F1300, 1900, 2800, 3200, BUS	681621	OSOVO281
	2.	DAF F65, 75, 85, 95, CF65, 75, 85, 95XF, XF95	681706	OSOVO282
	3.	DAF CF65, 75, 85, XF95, XF105	683499	OSOVO283
	4.	IVECO EUROTECH, EUROCARGO, EUROSTAR	190 4698	OSOVO284
	5.	IVECO EUROCARGO	190 4697	OSOVO285

DELOVI RUKAVACA				
Slika	Poz.	Tip vozila	OE broj	RAPIDEX broj
	6.	MAN F7/8/9, SL, SG	81.44205.6010	OSOV0229
	7.	MAN F90, M90, F2000, M2000, L2000	81.44205.6013	OSOV0230
	8.	MAN M90, M2000, NG, LION'S	81.44205.6018	OSOV0191
	9.	MAN F90	81.36305.0015S	VESA0583
	10.	MAN M2000, F2000	81.44205.6023	OSOV0136

DELOVI RUKAVACA				
Slika	Poz.	Tip vozila	OE broj	RAPIDEX broj
	11.	MAN	81.36305.6016S	OSOV0481
	12.	MAN L2000	81.44205.6024	OSOV0139
	13.	MAN L2000	81.44205.6020	OSOV0143
	14.	MAN L2000, M2000	81.44205.6025	OSOV0140
	15.	MERCEDES ACTROS, ACTROS MP2, AXOR 2, ATEGO	942 330 05 19	OSOV0266

DELOVI RUKAVCA				
Slika	Poz.	Tip vozila	OE broj	RAPIDEX broj
	16.	MERCEDES NG, SK, MK, AXOR, ACTROS, ACTROS MP2, ATEGO	625 330 01 19	VESA0432
	17.	MERCEDES LP NG, SK	360 330 07 19	OSOV0287
	18.	MERCEDES, NG, SK, MK, ACTROS, ACTROS MP2, ATEGO, AXOR	346 330 00 19	VESA0583
	19.	MERCEDES NG, SK	625 330 02 19	VESA0013
	20.	MERCEDES ACTROS, ACTROS MP2, ATEGO, NG, MK	346 330 01 19	VESA0616

DELOVI RUKAVCA				
Slika	Poz.	Tip vozila	OE broj	RAPIDEX broj
	21.	MERCEDES LK/LN	670 330 02 19	VESA0484
	22.	MERCEDES ACTROS, ATEGO, AXOR, MK, SK	326 330 02 19	VESA0754
	23.	MERCEDES ACTROS, ATEGO, AXOR 2, CITARO	655 330 04 19	VESA0751
	24.	MERCEDES 208, 207, 209, 210, 307, 309	601 330 00 19	VESA0691
	25.	MERCEDES NK, SK, 0303, 0405, 0407, 0408	300 330 00 19	VESA0425

DELOVI RUKAVCA				
Slika	Poz.	Tip vozila	OE broj	RAPIDEX broj
	26.	MERCEDES MK, NG, SK	391 330 00 19	VESA0688
	27.	SCANIA SERIJA 4 114, 124, 94, T114, T124	550284	OSO0204
	28.	SCANIA SERIJA 4 114, 124, 94, T114, T124	550257	OSO0288
	29.	VOLVO B12, F10, 12, 16, FL6, 7	0276030	OSO0289
	30.	VOLVO N10N	0276029	OSO0290

DELOVI RUKAVCA				
Slika	Poz.	Tip vozila	OE broj	RAPIDEX broj
	31.	VOLVO FL6, 7, 10, 12	3090267	OSO0291
	32.	VOLVO FH12, 16, FM10, 12	3090266	OSO0292
	33.	VOLVO FH12, 16, FM9, 10, 12	85108338	OSO0293



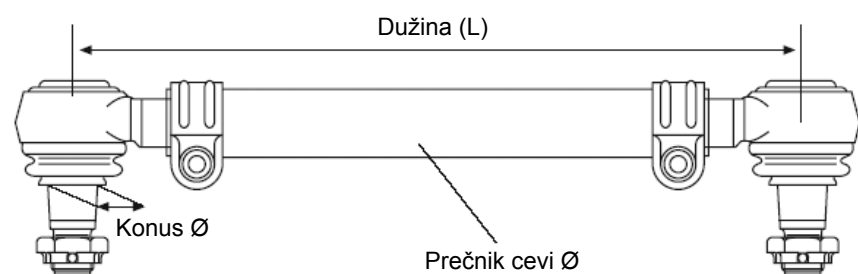

DAF				
Poz.	Tip vozila	Opis	OE broj	RAPIDEX broj
1.	LF45	Dužina: 900 (mm) Ø Cevi: 38 (mm) Ø Konusa: 19,3/22 (mm)	1700913	VESA0288
2.	95XF, 95	Dužina: 985 (mm) Ø Cevi: 52 (mm) Ø Konusa: 26 (mm)	1283203	VESA0857
3.	85, 95, 95XF	Dužina: 995 (mm) Ø Cevi: 52 (mm) Ø Konusa: 30 (mm)	554765	VESA0858
4.	95XF	Dužina: 1005 (mm) Ø Cevi: 52 (mm) Ø Konusa: 26 (mm)	071990	VESA0859

DAF				
Poz.	Tip vozila	Opis	OE broj	RAPIDEX broj
5.	75CF, 85CF, 95XF, F95	Dužina: 1615 (mm) Ø Cevi: 52 (mm) Ø Konusa: 26 (mm)	1353396 1286343	VESA0860
6.	65CF, 75CF, 85CF, 95XF	Dužina: 1698 (mm) Ø Cevi: 40 (mm) Ø Konusa: 26 (mm)	1353391 1270853	VESA0861

IVECO				
Poz.	Tip vozila	Opis	OE broj	RAPIDEX broj
1.	EUROCARGO	Dužina: 897 (mm) Ø Cevi: 42 (mm) Ø Konusa: 26 (mm)	04854874	VESA0862
2.	EUROTECH MT	Dužina: 900 (mm) Ø Cevi: 50 (mm) Ø Konusa: 30 (mm)	98446354	VESA0863
3.	EUROSTAR, EUROTECH, EUROTRAKKER, STRALIS	Dužina: 953 (mm) Ø Cevi: 52 (mm) Ø Konusa: 30 (mm)	08132397 41005463	VESA0864

IVECO				
Poz.	Tip vozila	Opis	OE broj	RAPIDEX broj
4.	EUROCARGO	Dužina: 1490 (mm) Ø Cevi: 38 (mm) Ø Konusa: 26 (mm)	98402553 500307556	VESA0865
5.	EUROSTAR, EUROTECH, EUROTRAKKER, STRALIS	Dužina: 1631 (mm) Ø Cevi: 48 (mm) Ø Konusa: 30 (mm)	41005451 8163773	VESA0866

MAN				
Poz.	Tip vozila	Opis	OE broj	RAPIDEX broj
1.	L2000, 1994→	Dužina: 825 (mm) Ø Cevi: 38 (mm) Ø Konusa: 22 (mm)	81.46610.6754 81.46610.6753 85.46610.6104	VESA0925
2.	L2000, 1994→	Dužina: 826 (mm) Ø Cevi: 32 (mm) Ø Konusa: 20 (mm)	85.46610.6201 85.46610.6030 81.46610.6725 85.46610.6102	VESA0045
3.	TGA, 2000→	Dužina: 967 (mm) Ø Cevi: 52 (mm) Ø Konusa: 30 (mm)	81.46611.6137 81.46611.6134 81.46611.6105 81.46611.6135	VESA0603







MAN				
Poz.	Tip vozila	Opis	OE broj	RAPIDEX broj
4.	TGA 2000→	Dužina: 993 (mm) Ø Cevi: 52 (mm) Ø Konusa: 30 (mm)	81.46611.6133	VESA0094
5.	F90 1988-1995, F2000 1994-1995	Dužina: 1040 (mm) Ø Cevi: 46 (mm) Ø Konusa: 30 (mm)	81.46610.6723 81.46610.6333 81.46610.6355 81.46610.6360 81.46610.6721 81.46610.6354	VESA0438
6.	F2000 1994-1995	Dužina: 1060 (mm) Ø Cevi: 48 (mm) Ø Konusa: 30 (mm)	81.46610.6782 81.46610.6779 81.46610.6780	VESA0109
7.	F90 1988-1995, F2000 1994-1995	Dužina: 1070 (mm) Ø Cevi: 48 (mm) Ø Konusa: 30 (mm)	81.46610.6656 81.46610.6659	VESA0479
8.	F90 1988-1995, F2000 1994-1995, L2000 1994→, M2000 1995→, TGA 2002→, TGM 2005→	Dužina: 1588 (mm) Ø Cevi: 52 (mm) Ø Konusa: 30 (mm)	81.46710.6122 81.46711.6736 81.46710.6380 81.46710.6836 81.46710.6378 81.46710.6830	VESA0594







MAN				
Poz.	Tip vozila	Opis	OE broj	RAPIDEX broj
9.	F90 1988-1995, F2000 1994-1995, M90 1990-1996, M2000 1995-2005	Dužina: 1628 (mm) Ø Cevi: 50 (mm) Ø Konusa: 30 (mm)	81.46711.6724 81.46710.6360 81.46710.6362 81.46710.6131 81.46710.6265 81.46710.6266	VESA0926
10.	L2000 1994→, M2000 1995-2005	Dužina: 1620 (mm) Ø Cevi: 36 (mm) Ø Konusa: 22 (mm)	81.46711.6719 81.46710.6851 81.46710.6852	VESA0927
11.	F90 1988-1995, F2000 1994-1995, M90 1990-1996, M2000 1995-2000, TGA 2002→	Dužina: 1652 (mm) Ø Cevi: 50 (mm) Ø Konusa: 30 (mm)	81.46710.6353 81.76710.6879 81.46710.6354 81.46711.6725 81.46710.6198 81.46710.6163	VESA0226
12.	F2000 1994-1995	Dužina: 1655 (mm) Ø Cevi: 50 (mm) Ø Konusa: 30 (mm)	81.46711.6726 81.46711.6729 81.46710.6994	VESA0928
13.	TGA 2000→, TGM 2005→	Dužina: 1729 (mm) Ø Cevi: 52 (mm) Ø Konusa: 30 (mm)	81.46711.6863 81.46711.6860 81.46711.6861	VESA0189





MERCEDES				
Poz.	Tip vozila	Opis	OE broj	RAPIDEX broj
1.	LK/LN2, NG	Dužina: 890 (mm) Ø Cevi: 40 (mm) Ø Konusa: 22 (mm)	383 460 24 05 383 460 08 05 383 460 16 05 383 460 45 05	VESA0771
2.	LK/LN2, NG	Dužina: 890 (mm) Ø Cevi: 40 (mm) Ø Konusa: 26 (mm)	383 460 44 05 383 460 06 05 383 460 14 05 383 460 23 05	VESA0867
3.	MK 1987-1996	Dužina: 830 (mm) Ø Cevi: 52 (mm) Ø Konusa: 32 (mm)	001 460 29 05 001 460 30 05	VESA0120
4.	MK, NG, SK 1987-1996	Dužina: 860 (mm) Ø Cevi: 42 (mm) Ø Konusa: 30 (mm)	619 460 25 05 619 460 29 05 619 460 52 05	VESA0184
5.	ATEGO 1998-2004, ATEGO 2 2004→	Dužina: 846 (mm) Ø Cevi: 42 (mm) Ø Konusa: 26 (mm)	970 460 07 05 970 460 09 05	VESA0208
6.	ATEGO 1998-2004, ATEGO 2 2004→	Dužina: 837 (mm) Ø Cevi: 40 (mm) Ø Konusa: 26 (mm)	972 460 14 05 972 460 16 05	VESA0225



MERCEDES				
Poz.	Tip vozila	Opis	OE broj	RAPIDEX broj
7.	ATEGO 1998-2004, ATEGO 2 2004→	Dužina: 894 (mm) Ø Cevi: 50 (mm) Ø Konusa: 30/26 (mm)	972 460 20 05	VESA0296
			972 460 18 05	
8.	ATEGO 1998-2004, ATEGO 2 2004→	Dužina: 894 (mm) Ø Cevi: 50 (mm) Ø Konusa: 26 (mm)	972 460 21 05	VESA0923
			972 460 19 05	
9.	ATEGO 1998-2004, ATEGO 2 2004→	Dužina: 873 (mm) Ø Cevi: 40 (mm) Ø Konusa: 26 (mm)	972 460 10 05	VESA0922
			972 460 12 05	
10.	ATEGO 1998-2004, ATEGO 2 2004→	Dužina: 884 (mm) Ø Cevi: 50 (mm) Ø Konusa: 30 (mm)	974 460 04 05	VESA0921
			974 460 08 05	
11.	ATEGO 1998-2004, ATEGO 2 2004→	Dužina: 894 (mm) Ø Cevi: 50 (mm) Ø Konusa: 30 (mm)	974 460 12 05	VESA0224
			974 460 10 05	
12.	ATEGO, AXOR, AXOR 2, ACTROS 1997-2002, ACTROS MP2 2003→	Dužina: 879 (mm) Ø Cevi: 42 (mm) Ø Konusa: 30 (mm)	001 460 67 05	VESA0828
			000 460 71 05	
	000 460 72 05			







MERCEDES				
Poz.	Tip vozila	Opis	OE broj	RAPIDEX broj
13.	MK, NG, SK, ATEGO, AXOR, AXOR 2, ACTROS 1997-2002, ACTROS MP2 2003→	Dužina: 873 (mm) Ø Cevi: 40 (mm) Ø Konusa: 30 (mm)	000 460 93 05	VESA0702
			000 460 92 05	
	001 460 69 05			
14.	MK, NG, SK, ATEGO, AXOR, AXOR 2, ACTROS 1997-2002, ACTROS MP2, 2003→	Dužina: 866 (mm) Ø Cevi: 38 (mm) Ø Konusa: 30 (mm)	001 460 98 05	VESA0903
			001 460 99 05	
15.	ATEGO, AXOR 2, ACTROS 1997-2002, ACTROS MP2 2003→	Dužina: 879 (mm) Ø Cevi: 36 (mm) Ø Konusa: 28,6 (mm)	002 460 44 05	VESA0147
			002 460 43 05	
16.	MK, NG, SK, ATEGO, AXOR, AXOR 2, ACTROS 1997-2002, ACTROS MP2 2003→	Dužina: 876 (mm) Ø Cevi: 40 (mm) Ø Konusa: 28,6 (mm)	002 460 48 05	VESA0209
			002 460 47 05	
17.	ATEGO 1998-2004, AXOR 2002-2004, AXOR 2 2004→	Dužina: 895 (mm) Ø Cevi: 40 (mm) Ø Konusa: 28,6 (mm)	002 460 49 05	VESA0038
			002 460 50 05	
18.	ATEGO, AXOR, AXOR 2, ACTROS 1997-2002, ACTROS MP2 2003→	Dužina: 895 (mm) Ø Cevi: 36 (mm) Ø Konusa: 28,6 (mm)	002 460 46 05	VESA0167
			002 460 45 05	



MERCEDES				
Poz.	Tip vozila	Opis	OE broj	RAPIDEX broj
19.	ACTROS 1996-2002, ACTROS MP2 2003→	Dužina: 858 (mm) Ø Cevi: 40 (mm) Ø Konusa: 28,6 (mm)	002 460 97 05 002 460 96 05	VESA0902
				
20.	LK/LN2, NG 1987-1996	Dužina: 1638 (mm) Ø Cevi: 46 (mm) Ø Konusa: 22 (mm)	358 330 01 03 358 330 05 03 381 330 03 03 381 330 05 03	VESA0898
				
21.	LK/LN2, NG 1987-1996	Dužina: 1611 (mm) Ø Cevi: 46 (mm) Ø Konusa: 26 (mm)	385 330 05 03 385 330 06 03 385 330 11 03 385 330 14 03	VESA0900
				
22.	ATEGO 1998-2004, ATEGO 2 2004→	Dužina: 1640 (mm) Ø Cevi: 40 (mm) Ø Konusa: 26 (mm)	970 330 02 03 970 330 00 03 970 330 01 03 970 330 04 03	VESA0723
				
23.	ATEGO 1998-2004, ATEGO 2 2004→	Dužina: 1605 (mm) Ø Cevi: 40 (mm) Ø Konusa: 30 (mm)	975 330 02 03 975 330 03 03 975 330 08 03 975 330 17 03	VESA0039
				
24.	LK/LN2 1992-1998, ATEGO 1998-2004	Dužina: 1435 (mm) Ø Cevi: 52 (mm) Ø Konusa: 26 (mm)	676 330 13 03 676 330 14 03	VESA0894
				



MERCEDES				
Poz.	Tip vozila	Opis	OE broj	RAPIDEX broj
25.	ATEGO 2 1015-1024, 1214-1229 10/04→	Dužina: 1560 (mm) Ø Cevi: 40 (mm) Ø Konusa: 30 (mm)	975 330 09 03 975 330 07 03 975 330 06 03	VESA0893
				
26.	ATEGO 2 1214-1229, 1524-1529 10/04→	Dužina: 1565 (mm) Ø Cevi: 60 (mm) Ø Konusa: 30 (mm)	975 330 10 03 975 330 00 03 975 330 04 03	VESA0892
				
27.	ATEGO, AXOR, AXOR 2, ACTROS 1996-2002, ACTROS MP2, 2003→	Dužina: 1735 (mm) Ø Cevi: 52 (mm) Ø Konusa: 32 (mm)	942 330 00 03, 942 330 01 03, 942 330 02 03, 942 330 07 03, 942 330 11 03	VESA0188
				
28.	ATEGO, AXOR 2, ACTROS 1996-2002, ACTROS MP2, 2003→	Dužina: 1735 (mm) Ø Cevi: 62 (mm) Ø Konusa: 32 (mm)	945 330 00 03 945 330 01 03 945 330 04 03 945 330 06 03	VESA0190
				
29.	ATEGO, AXOR, ACTROS 1996-2002	Dužina: 1565 (mm) Ø Cevi: 50 (mm) Ø Konusa: 32 (mm)	942 330 09 03 942 330 05 03 942 330 06 03	VESA0744
				
30.	ATEGO, AXOR, ACTROS 1996-2002, ACTROS MP2, 2003→	Dužina: 1735 (mm) Ø Cevi: 50 (mm) Ø Konusa: 32 (mm)	941 330 02 03 941 330 00 03 941 330 01 03 941 330 03 03	VESA0127
				







MERCEDES				
Poz.	Tip vozila	Opis	OE broj	RAPIDEX broj
31.	ATEGO, AXOR, ACTROS 1996-2002, ACTROS MP2, 2003→	Dužina: 1465 (mm) Ø Cevi: 40 (mm) Ø Konusa: 32 (mm)	945 330 02 03 945 330 03 03 945 330 05 03	VESA0891
				
32.	ATEGO, AXOR, ACTROS 1996-2002, ACTROS MP2 2003→	Dužina: 1687 (mm) Ø Cevi: 52 (mm) Ø Konusa: 32 (mm)	949 330 16 03 949 330 06 03 949 330 15 03	VESA0890
				
33.	MK, NG, SK, ATEGO, AXOR, ACTROS 1996-2002, ACTROS MP2 2003→	Dužina: 1625 (mm) Ø Cevi: 52 (mm) Ø Konusa: 32 (mm)	949 330 02 03 949 330 03 03 942 330 08 03 949 330 09 03	VESA0889
				
34.	ATEGO, AXOR, ACTROS 1996-2002, ACTROS MP2 2003→	Dužina: 1664 (mm) Ø Cevi: 50 (mm) Ø Konusa: 32 (mm)	942 330 03 03 942 330 04 03 942 330 16 03	VESA0037
				

RENAULT				
Poz.	Tip vozila	Opis	OE broj	RAPIDEX broj
.1.	MAGNUM AE 1992-1996, MAGNUM E TECH 2000→	Dužina: 720 (mm) Ø Cevi: 40 (mm) Ø Konusa: 30 (mm)	5010060764 5010557243	VESA0884
				
2.	PREMIUM ROUTE 1996→	Dužina: 809 (mm) Ø Cevi: 50 (mm) Ø Konusa: 30 (mm)	5010294288	VESA0885
				

SCANIA				
Poz.	Tip vozila	Opis	OE broj	RAPIDEX broj
1.	SERIJA 3 (93,113,143) 01/90-12/96	Duzina: 872 (mm) Ø Cevi: 50 (mm) Ø Konusa: 30 (mm)	345 124	VESA0914
				
2.	SERIJA 3 (93,113,143) 01/90-12/96	Duzina: 1752 (mm) Ø Cevi: 60 (mm) Ø Konusa: 30 (mm)	310 977	VESA0919
				
3.	SERIJA 4 (94,114, 124) 1996→, SERIJA P, R, T 2001→	Dužina: 420 (mm) Ø Cevi: 40 (mm) Ø Konusa: 30/26 (mm)	1 394 884	VESA0918
				
4.	SERIJA 4 (94,114, 124) 1996→	Dužina: 435 (mm) Ø Cevi: 38 (mm) Ø Konusa: 30 (mm)	1 759 691 1 343 283	VESA0093
				
5.	SERIJA 4 (94,114, 124) 1996→, SERIJA P, R, T 2001→	Dužina: 1054 (mm) Ø Cevi: 52 (mm) Ø Konusa: 30 (mm)	1 379 071 1 356 055 1 384 025	VESA0607
				
6.	SERIJA 4 (94,114, 124) 1996→, SERIJA P, R, T 2001→	Dužina: 1059 (mm) Ø Cevi: 52 (mm) Ø Konusa: 30 (mm)	1 384 027 1 769 597	VESA0737
				

SCANIA				
Poz.	Tip vozila	Opis	OE broj	RAPIDEX broj
7.	SERIJA 4 (94,114, 124) 1996→	Dužina: 1743 (mm) Ø Cevi: 42 (mm) Ø Konusa: 30 (mm)	1 378 435	VESA0920
				
8.	SERIJA 4 (94,114, 124) 1996→, SERIJA P, R, T 2001→	Dužina: 1743 (mm) Ø Cevi: 50 (mm) Ø Konusa: 30 (mm)	1 409 918 1 501 030 1 723 895 1 737 683 1 897 335 1 385 251	VESA0475
				
9.	SERIJA 4 (94,114, 124) 1996→, SERIJA P, R, T 2001→	Dužina: 1743 (mm) Ø Cevi: 62 (mm) Ø Konusa: 30 (mm)	1 361 413 1 897 333 1 395 614 1 734 019	VESA0454
				

VOLVO				
Poz.	Tip vozila	Opis	OE broj	RAPIDEX broj
1.	F10, F12, F16	Duzina: 850 (mm) Ø Cevi: 42 (mm) Ø Konusa: 31,5 (mm)	1 626 751 1 610 338	VESA0680
				
2.	FH12, FH16 1993→, FM7 1998-2001, FM10 1999-2001, FM12 1998-2005	Dužina: 860 (mm) Ø Cevi: 52 (mm) Ø Konusa: 28,6 (mm)	20393063 1075664 3988701	VESA0909
				
3.	FH12, FH16 1993→, FM7 1998-2001, FM10 1999-2001, FM12 1998-2005	Dužina: 861 (mm) Ø Cevi: 52 (mm) Ø Konusa: 28,6 (mm)	20393069 1075663 3988704	VESA0213
				

VOLVO				
Poz.	Tip vozila	Opis	OE broj	RAPIDEX broj
4.	FH12, FH16 1993→	Dužina: 863 (mm) Ø Cevi: 50 (mm) Ø Konusa: 28,6 (mm)	1075005	VESA0910
				
5.	FH12, FH16 1993→, FM7 1998-2001, FM10 1999-2001, FM12 1998-2005	Dužina: 869 (mm) Ø Cevi: 50 (mm) Ø Konusa: 28,6 (mm)	20393075 1629397	VESA0911
				
6.	FH12, FH16 1993→, FM7 1998-2001, FM10 1999-2001, FM12 1998-2005	Dužina: 881 (mm) Ø Cevi: 52 (mm) Ø Konusa: 28,6 (mm)	3988698 3988700 2039059	VESA0929
				
7.	FH12, FH16 1993→, FM7 1998-2001, FM10 1999-2001	Dužina: 881 (mm) Ø Cevi: 52 (mm) Ø Konusa: 28,6 (mm)	3988695 1075153	VESA0904
				
8.	B6, B7, B10, B12 1992→	Dužina: 300 (mm) Ø Cevi: 36 (mm) Ø Konusa: 28,6 (mm)	20497798 9959151 3112050	VESA0216
				
9.	B10, B12 1992→	Dužina: 1025 (mm) Ø Cevi: 60 (mm) Ø Konusa: 28,8 (mm)	9519278 20490123 20745923	VESA0160
				

VOLVO				
Poz.	Tip vozila	Opis	OE broj	RAPIDEX broj
10.	B10, B12 1992→	Dužina: 1025 (mm) Ø Cevi: 60 (mm) Ø Konusa: 31,5 (mm)	1197338	VESA0186
11.	FH12, FH16 1993→, FM7 1998-2001, FM10 1999-2001, FM12 1998-2005	Dužina: 1645 (mm) Ø Cevi: 42 (mm) Ø Konusa: 28,6 (mm)	3962343, 1626637, 3986450, 3988711	VESA0839
12.	FH12, FH16 1993→, FH13 2005→, FM9 2001-2005, FM12 1998-2005, FM 2005→	Dužina: 1634 (mm) Ø Cevi: 50 (mm) Ø Konusa: 28,6 (mm)	3198276 21260274	VESA0905
13.	FH12, FH16 1993→, FM9 2001-2005, FM12 1998-2005	Dužina: 1660 (mm) Ø Cevi: 60 (mm) Ø Konusa: 28,6 (mm)	3198234 21260275	VESA0906
14.	FH12, FH16 1993→, FH13 2005→, FM9 2001-2005, FM12 1998-2005, FM 2005→	Dužina: 1660 (mm) Ø Cevi: 60 (mm) Ø Konusa: 32 (mm)	20587731 21106938	VESA0907
15.	FH12, FH16 1993→, FM9 2001-2005, FM12 1998-2005	Dužina: 1818 (mm) Ø Cevi: 52 (mm) Ø Konusa: 28,6 (mm)	20399543 85115631	VESA0908

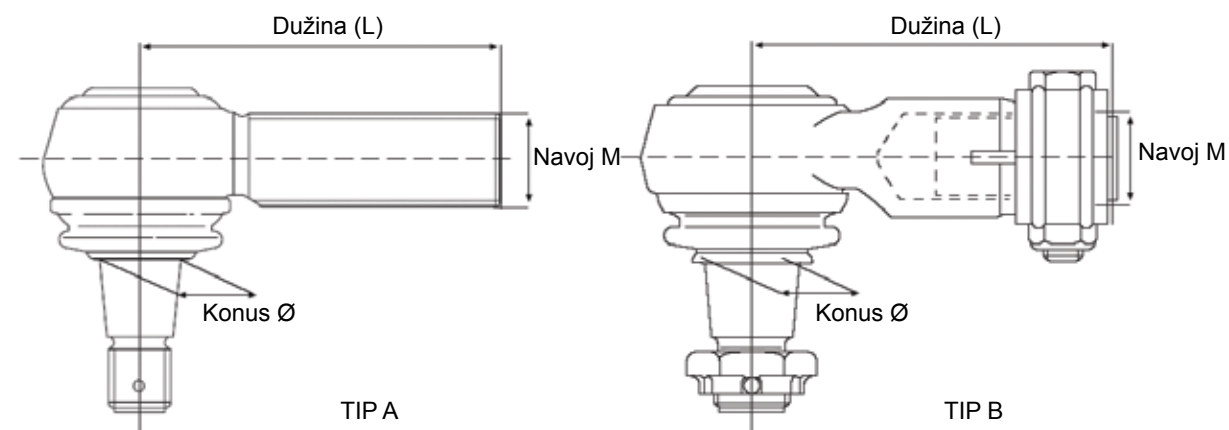

DELOVI SPONA							
Poz.	Tip vozila	Dužina L (mm)	Konus Ø (mm)	Navoj M (mm)	Tip A/B	OE broj	RAPIDEX broj
1.	DAF, IVECO, MAN, MERCEDES, SCANIA	55	-	M12 x 1.75 ∪	B	81.95301.6063	VESA0842
2.	DAF, IVECO, MAN, MERCEDES, SCANIA	55	-	M12 x 1.75 ∪	B	81.95301.6064	VESA0843
3.	MERCEDES SPRINTER	76	18	M16 x 1.5 ∪	B	901 460 01 48	VESA0114
4.	IVECO, MAN, SCANIA	80	30	M26 x 1.5 ∪	B	81.95301.6219	VESA0844
5.	DAF, IVECO, MAN, MERCEDES, RENAULT, VOLVO	95	20	M24 x 1.5 ∪	A	000 330 85 35	VESA0182
6.	DAF, IVECO, MAN, MERCEDES, RENAULT, VOLVO	95	20	M24 x 1.5 ∪	A	000 330 86 35	VESA0183
7.	MAN, MERCEDES, SCANIA	95	30	M26 x 1.5 ∪	B	000 460 49 48	VESA0845
8.	IVECO, MERCEDES, VOLVO	105	22	M24 x 1.5 ∪	A	000 330 12 35	VESA0098
9.	IVECO, MERCEDES, VOLVO	105	22	M24 x 1.5 ∪	A	000 330 13 35	VESA0099
10.	DAF, IVECO, MAN, MERCEDES, RENAULT, VOLVO	105	22	M28 x 1.5 ∪	A	000 330 14 35	VESA0096

DELOVI SPONA							
Poz.	Tip vozila	Dužina L (mm)	Konus Ø (mm)	Navoj M (mm)	Tip A/B	OE broj	RAPIDEX broj
11.	DAF, IVECO, MAN, MERCEDES, RENAULT, VOLVO	105	22	M28 x 1.5 U	A	000 330 15 35	VESA0097
12.	MERCEDES	115	22	M30 x 1.5 U	A	000 330 31 35	VESA0100
13.	IVECO, NEOPLAN	115	26	M28 x 1.5 U	A	8582333	VESA0192
14.	IVECO, NEOPLAN	115	26	M28 x 1.5 U	A	8582332	VESA0193
15.	DAF, IVECO, MAN, MERCEDES, RENAULT	115	26	M30 x 1.5 U	A	000 330 01 48	VESA0018
16.	DAF, IVECO, MAN, MERCEDES, RENAULT	115	26	M30 x 1.5 U	A	000 330 02 48	VESA0846
17.	MERCEDES	120	30	M24 x 1.5 U	A	001 460 21 48	VESA0050
18.	MERCEDES	120	30	M24 x 1.5 U	A	001 460 20 48	VESA0051
19.	DAF, IVECO, KÄSSBOHRER, MAN, MERCEDES, RENAULT	120	26	M30 x 1.5 U	A	000 460 01 48	VESA0847
20.	DAF, EVOBUS, IVECO, KÄSSBOHRER, MAN, MERCEDES, RENAULT, SCANIA, VAN HOOL	120	30	M30 x 1.5 U	A	000 340 11 70	VESA0736
21.	DAF, EVOBUS, IVECO, KÄSSBOHRER, MAN, MERCEDES, RENAULT, SCANIA, VAN HOOL	120	30	M30 x 1.5 U	A	000 340 61 69	VESA0758
22.	VOLVO	120	31.5	M30 x 1.5 U	A	1698840	VESA0774
23.	VOLVO	120	31.5	M30 x 1.5 U	A	1698557	VESA0689
24.	MERCEDES	120	32	M30 x 1.5 U	A	000 460 58 48	VESA0742
25.	MERCEDES	120	32	M30 x 1.5 U	A	000 460 57 48	VESA0848
26.	IVECO, RENAULT	120	30	M38 x 1.5 U	A	4688948	VESA0849
27.	VOLVO	125	28.6	M30 x 1.5 U	A	3090727	VESA0161
28.	VOLVO	125	28.6	M30 x 1.5 U	A	3090728	VESA0162

DELOVI SPONA							
Poz.	Tip vozila	Dužina L (mm)	Konus Ø (mm)	Navoj M (mm)	Tip A/B	OE broj	RAPIDEX broj
29.	DAF	133	30	M46 x 1.5 U	B	67303	VESA0850
30.	DAF	133	30	M46 x 1.5 U	B	67389	VESA0851
31.	SCANIA	135	30	M30 x 1.5 U	A	1 337 366	VESA0125
32.	DAF, MAN, SCANIA	135	30	M30 x 1.5 U	A	81.95301.0022	VESA0820
33.	KÄSSBOHRER, MERCEDES, SAF	135	38	M38 x 1.5 U	A	000 460 17 48	VESA0852
34.	MERCEDES	150	26	M35 x 1.5 U	B	000 330 40 35	VESA0853
35.	MERCEDES	150	26	M35 x 1.5 U	B	000 330 19 35	VESA0854
36.	MAN, MERCEDES	155	30	M30 x 1.5 U	A	81.95301.6263	VESA0222
37.	VOLVO	168	28.6	M52 x 1.5 U	B	1131742	VESA0855
38.	VOLVO	168	28.6	M52 x 1.5 U	B	1131741	VESA0856
39.	MAN, MERCEDES	168	30	M52 x 1.5 U	B	000 460 67 48	VESA0102



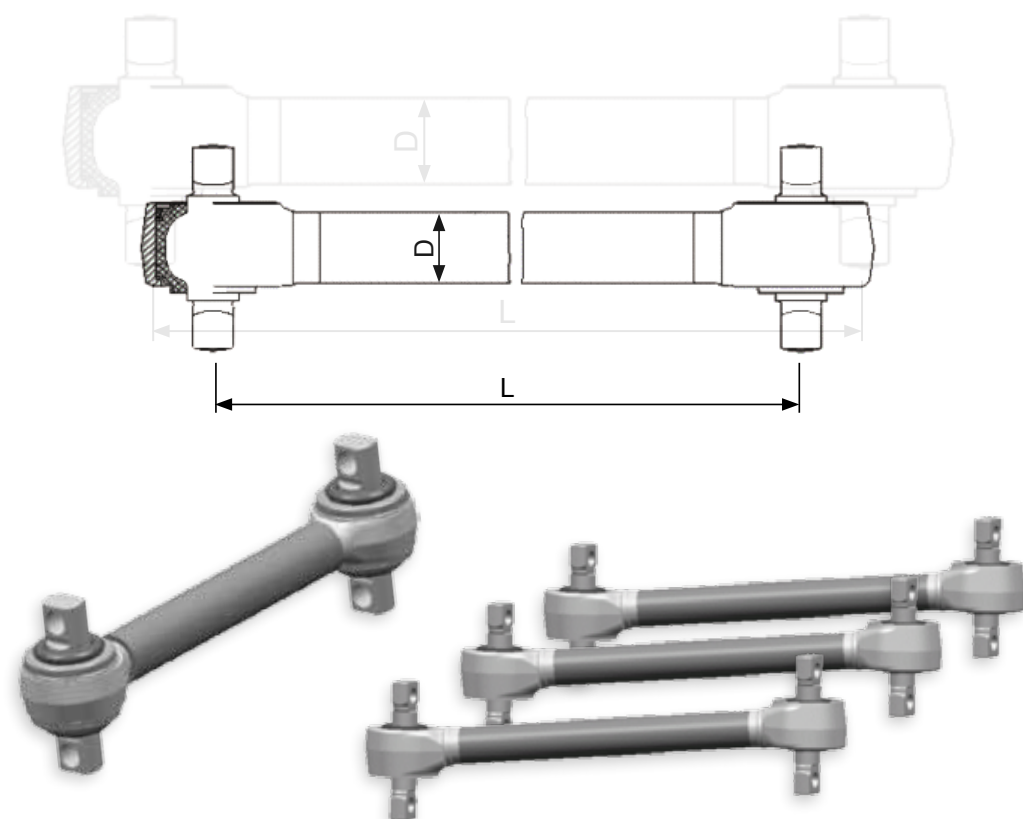

DAF							
Poz.	Tip vozila	L (mm)	D (mm)	Reparatur set	Lemförder broj	OE broj	RAPIDEX broj
1.	85, 95, 95XF, XF95	605	48	-	22317 02	1361649	VESA0995

IVECO							
Poz.	Tip vozila	L (mm)	D (mm)	Reparatur set	Lemförder broj	OE broj	RAPIDEX broj
1.	Turbo Star 190-33 - 190-48, Turbo Tech 190-26 - 220-36	583	48	42535446	11738 01	42125057	VESA0993
2.	Euro Cargo 260-320E 01/92→, Euro Star LD 260-440E 01/93-02/02, Euro Tech MP 240-440E 01/92→, Euro Trakker MP 260-440E 01/93-11/04	610	50	93192618	19991 01	42041107	VESA0994

MAN							
Poz.	Tip vozila	L (mm)	D (mm)	Reparatur set	Lemförder broj	OE broj	RAPIDEX broj
1.	F90, F2000 01/94→	590	48	81.95302.0059	18495 01	81.43220.6090	VESA0582
2.	F90, F2000, M2000, M90, TGA 26310-26530 12/00→	571	48	85.43220.6002	11757 02	81.43220.6129	VESA0450
3.	F90, F2000, M2000, M90, TGA 26310-26530 12/00→	571	50	81.43230.6043	11757 02	81.43230.6030	VESA0581
4.	TGA 18310-18533 04/00→, TGA 24350-28530 09/02→, TGA 32310-35530 09/02→, TGA 41360-41660 09/02→	566	50	85.43220.6002	-	81.43220.6236	VESA0435
5.	F2000 08/95→, TGA 18310-18530 04/00→, TGA 26310-26530 02/02→, TGA 32310-35530 09/02→	596	48	-	25041 01	81.43220.6196	VESA0992
6.	TGA 18310-18533 04/00→, TGA 26310-26530 09/02→	572	52	85.43220.6002	28329 01	81.43220.6268	VESA0452
7.	TGA 18310-18533 04/00→, TGA 26310-26530 09/02→	941	60	81.43220.6244	25207 01	81.43220.6260	VESA0593
8.	M90	755	50	81.43220.6132	21418 01	81.43230.6038	VESA0991

MERCEDES							
Poz.	Tip vozila	L (mm)	D (mm)	Reparatur set	Lemförder broj	OE broj	RAPIDEX broj
1.	Actros MP2 2536-2555LS 04/03→	850	62	000 330 14 11	22055 01	945 330 00 07	VESA0629
2.	Actros MP2 2551LS 04/03→	845	60	000 330 14 11	22092 01	941 330 00 07	VESA0983
3.	Actros 2535-4148 04/97-10/02→, Actros MP2 3331-4151 04/03→	565	50	000 350 27 05	29461 01	948 350 06 05	VESA0984
4.	NG 2219, 2219L, 2222, 2222L	500	50	000 350 19 05	19715 01	385 350 00 06	VESA0460
5.	NG 2219-2224	610	50	000 350 02 13	12907 01	385 350 01 06	VESA0628
6.	NG 1628-3544, SK 1728-3253	595	62	000 350 02 13	13571 01	620 350 01 06	VESA0482
7.	O340 Turismo	585	56	-	11413 01	317 350 06 06	VESA0562

RENAULT							
Poz.	Tip vozila	L (mm)	D (mm)	Reparatur set	Lemförder broj	OE broj	RAPIDEX broj
1.	Kerax, Premium	575	50	-	33401 01	5010467915	VESA0985

SCANIA							
Poz.	Tip vozila	L (mm)	D (mm)	Reparatur set	Lemförder broj	OE broj	RAPIDEX broj
1.	93, 94, 111, Serija 4 05/96→	752	48	1517403	23003 01	1 379 423	VESA0986
2.	Serija 4 09/96→	568	46	1104334	21462 01	1 338 769	VESA0987

VOLVO							
Poz.	Tip vozila	L (mm)	D (mm)	Reparatur set	Lemförder broj	OE broj	RAPIDEX broj
1.	FL7 (6 x 4), F12 (6 x 2), F12, FH12 (6 x 4) Do broja šasije 43812	660	48	274019	23034 01	1607079	VESA0988
2.	F12, FH12 (6 x 4) Od broja šasije 43813	666	48	1598588	20422 01	1629072	VESA0989
3.	FL12	666	48	1598588	25529 01	1082104	VESA0990



DAF							
Poz.	Tip vozila	L (mm)	D (mm)	Reparatur set	Lemförder broj	OE broj	RAPIDEX broj
1.	95, 95XF, 310/330/350/380ATi	608	50	1376729 (2x)	26691 01	1390932	VESA0982

IVECO							
Poz.	Tip vozila	L (mm)	D (mm)	Reparatur set	Lemförder broj	OE broj	RAPIDEX broj
1.	Euro Cargo 120E-320E 01/92→, Euro Cargo 120, 130, 150E Tector	659	46	93161958 (1x) 93161960 (2x)	23049 01	41022092	VESA0981
2.	Euro Star LD, Euro Tech MP, Euro Tech MT, Euro Trakker MP, Stralis AS260S40-54, Stralis AS440S40-54	665	46	93161958 (1x) 93161960 (2x)	11715 01	41042050	VESA0101

MAN							
Poz.	Tip vozila	L (mm)	D (mm)	Reparatur set	Lemförder broj	OE broj	RAPIDEX broj
1.	F90, F2000	621	50	81.43270.6080 (1x)	11760 02	81.43270.6034	VESA0146
2.	TGA 18310-530, TGA 26310-530 TGA 32310-35530 10/03→	627	48	81.43270.6080 (1x) 81.43270.6105 (2x)	25210 01	81.43270.6096	VESA0436
3.	TGA 18360, 26310-530, 33360-530	627	58	81.95301.6132 (1x)	30416 01	81.43270.6117	VESA0252
4.	F2000 08/95→, TGA 18310-530, 26310-530, 32310-480, 33360-530	627	48	81.43270.6105 (2x)	26053 01	81.43270.6087	VESA0251

MERCEDES							
Poz.	Tip vozila	L (mm)	D (mm)	Reparatur set	Lemförder broj	OE broj	RAPIDEX broj
1.	NG, Econic, Actros 2031, 2540, Actros MP2, Atego 2528, Axor 2 2528 prateća osovina	622	46	000 350 4605 (1x) 000 350 4705 (2x)	23065 01	942 350 11 05	VESA0449
2.	Econic, Actros 1831-3343, Actros MP2, Axor 2 1823-3240, Atego 1823-2628,	622	48	000 350 2305 (1x) 000 350 2205 (2x)	21168 01	942 350 10 05	VESA0439
3.	Actros 2535-4148 04/97-10/02, Actros MP2 04/03→, Atego 2628, Axor 2 2628-3243 10/04→	622	46	000 350 3505 (1x) 000 350 3405 (2x)	23069 02	948 350 30 05	VESA0019
4.	Actros 1831-1857 04/96-10/02, Actros MP2 04/03→, Atego 1823-28, Axor 2535 01/02-10/04, Axor 2 10/04→	622	46	000 350 5105 (1x) 000 350 4805 (2x)	31887 01	942 350 12 05	VESA0085
5.	Actros 3331-4140 04/97→10/02, Actros MP2 04/03→	622	60	000 350 3605 (1x) 000 350 3705 (2x)	26031 01	948 350 22 05	VESA0206
6.	Actros 3331-3357 04/97-10/02, Actros 4140-4148, Actros MP2	667	60	000 350 3605 (1x) 000 350 3705 (2x)	25314 01	948 350 23 05	VESA0253

RENAULT							
Poz.	Tip vozila	L (mm)	D (mm)	Reparatur set	Lemförder broj	OE broj	RAPIDEX broj
1.	Kerax, Premium	671	58	-	29836 01	7420829503	VESA0980

SCANIA							
Poz.	Tip vozila	L (mm)	D (mm)	Reparatur set	Lemförder broj	OE broj	RAPIDEX broj
1.	113, Serija 4	827	48	638938 (1x) 638862 (2x)	18478 01	418038	VESA0979

VOLVO							
Poz.	Tip vozila	L (mm)	D (mm)	Reparatur set	Lemförder broj	OE broj	RAPIDEX broj
1.	FL7, FL10, F16, F12, FH12 (6 x 4) Od broja šasije 43813	685	52	-	-	1628483	VESA0978
2.	F12, FH12 (6 x 4), FM12, FM16	677	48	271188 (1x)	25116 01	3172829	VESA0977
3.	FL10 (6 x 4, 6 x 6, 8 x 4), F12, FH12 (6 x 4) Do broja šasije 43812	635	58	276191 (1x) 276192 (2x)	11819 01	1606200	VESA0976
4.	FL10, F12, FH12 (6 x 4) Od broja šasije 43813	680	48	1591689 (1x) 1628107 (2x)	27765 01	20556490	VESA0975
5.	FH12, FH16, FH400-520 09/05→, FM10, FM12, FM7, FM9, NH12	671	58	3090712 (1x) 3093631 (2x)	29836 01	20392649	VESA0029
6.	FH12, FH16, FH400-520 09/05→ FL6, FM12, FM9, FM300-480	662,4	48	20741710 (1x) 20547286 (2x)	26058 01	20741703	VESA0032

6.0 KABINA I DELOVI KABINE



6.0 KABINA I DELOVI KABINE

6.1	Delovi kabine	412
6.2	Ogledala i delovi ogledala	510
6.3	Cilindri i pumpe za dizanje kabine	522
6.4	Elementi za oslanjanje kabine	527
6.5	Uređaji za pranje vetrobranskog stakla	541
6.6	Mehanizam vrata	545

[NAZAD NA GLAVNI SADRŽAJ](#)

PREĐI NA LISTU UPOREDNIH OE I RAPIDEX BROJEVA - DAF



KARO0062



KARO0060



KARO0061



KARO0652

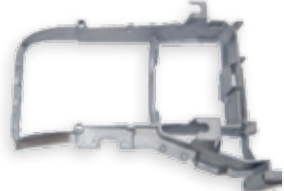

KARO0653

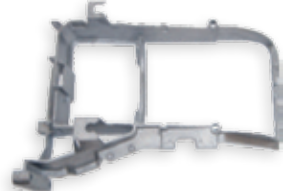

KARO0058



KARO0059



RASV0599



RASV0600



PREĐI NA LISTU UPOREDNIH OE I RAPIDEX BROJEVA - DAF



KARO0654



KARO0655



KARO0656



KARO0657



KARO0067



KARO0063



KARO0066



KARO0065



KARO0064



KARO0068



PREĐI NA LISTU UPOREDNIH OE I RAPIDEX BROJEVA - DAF



KARO0069



KARO0070



KARO0071



KARO0072



KARO0073



KARO0074



KARO0075

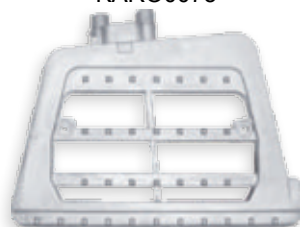

KARO0076

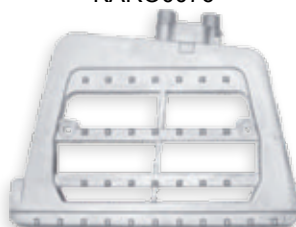

PREĐI NA LISTU UPOREDNIH OE I RAPIDEX BROJEVA - DAF



KARO0077



KARO0847



KARO0848



KARO0078



KARO0658



KARO0659



KARO0079



KARO0080



KARO0081



POGLED OD NAZAD



POGLED OD NAZAD



KARO0082



6.1 DELOVI KABINE - DAF CF/XF 95-105

PREĐI NA LISTU UPOREDNIH OE I RAPIDEX BROJEVA - DAF



KARO0083



KARO0086



KARO0085



KARO0085



KARO0084



6.1 DELOVI KABINE - DAF XF 95

PREĐI NA LISTU UPOREDNIH OE I RAPIDEX BROJEVA - DAF



KARO0849



KARO0099 *



KARO0104 *



KARO0096



KARO0097



KARO100



KARO0101



KARO0102 *



KARO0105 *



KARO0103 *



KARO0107 *



* DAF XF 95 SERIJA 1-2

PREĐI NA LISTU UPOREDNIH OE I RAPIDEX BROJEVA - DAF



KARO0108



KARO0109



RASV0283



+

RASV0282



KARO0110



KARO0114

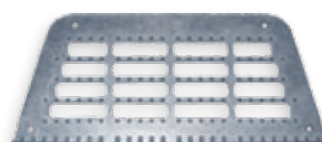

KARO0111



KARO0115



* DAF XF 95 SERIJA 1-2

PREĐI NA LISTU UPOREDNIH OE I RAPIDEX BROJEVA - DAF



KARO0112 *



KARO0113 *



KARO0116 (SERIJA 1)



KARO0117 (SERIJA 1)



KARO0118 *



KARO0119 *



KARO0121 (SERIJA 2)



KARO0122 (SERIJA 2)



KARO0120 *



PREĐI NA LISTU UPOREDNIH OE I RAPIDEX BROJEVA - DAF



KARO0123



KARO0124
(SERIJA 2)



KARO0126
(SERIJA 2)



KARO0125



KARO0127
(SERIJA 2)



KARO0130 *



KARO0131 *



KARO0128
(SERIJA 2)



KARO0129



KARO0132 *



KARO0133 *



KARO0133 *



KARO0132 *

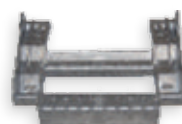

* DAF XF 95 SERIJA 1-2

PREĐI NA LISTU UPOREDNIH OE I RAPIDEX BROJEVA - DAF



KARO0660



KARO0661



KARO0134



KARO0135



KARO0662



KARO0663



KARO0664

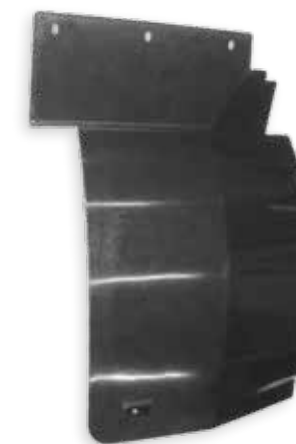

KARO0665

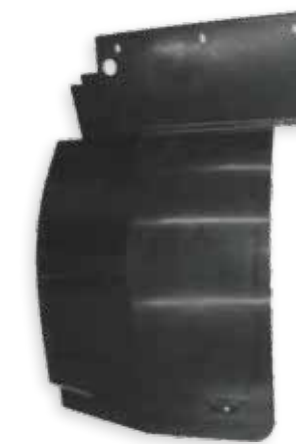

KARO0666



POGLED OD NAZAD



POGLED OD NAZAD



KARO0667



6.1 DELOVI KABINE - DAF XF 105

PREĐI NA LISTU UPOREDNIH OE I RAPIDEX BROJEVA - DAF



6.1 DELOVI KABINE - IVECO STRALIS 2001

PREĐI NA LISTU UPOREDNIH OE I RAPIDEX BROJEVA - IVECO



PREĐI NA LISTU UPOREDNIH OE I RAPIDEX BROJEVA - IVECO



KARO0011



KARO0010



KARO0012



KARO0013



RASV0337



RASV0335



KARO0014



KARO0017

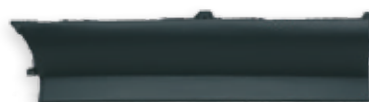

KARO0016

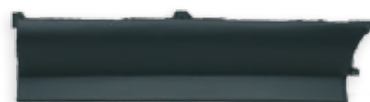

KARO0015



PREĐI NA LISTU UPOREDNIH OE I RAPIDEX BROJEVA - IVECO



KARO0678



KARO0679



KARO0680



KARO0681



KARO0018



KARO0019



KARO0020

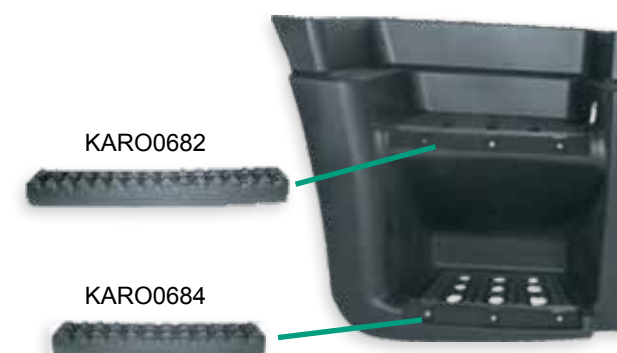

KARO0021



KARO0682



KARO0683



KARO0684



KARO0685



PREĐI NA LISTU UPOREDNIH OE I RAPIDEX BROJEVA - IVECO



PREĐI NA LISTU UPOREDNIH OE I RAPIDEX BROJEVA - IVECO



PREĐI NA LISTU UPOREDNIH OE I RAPIDEX BROJEVA - IVECO

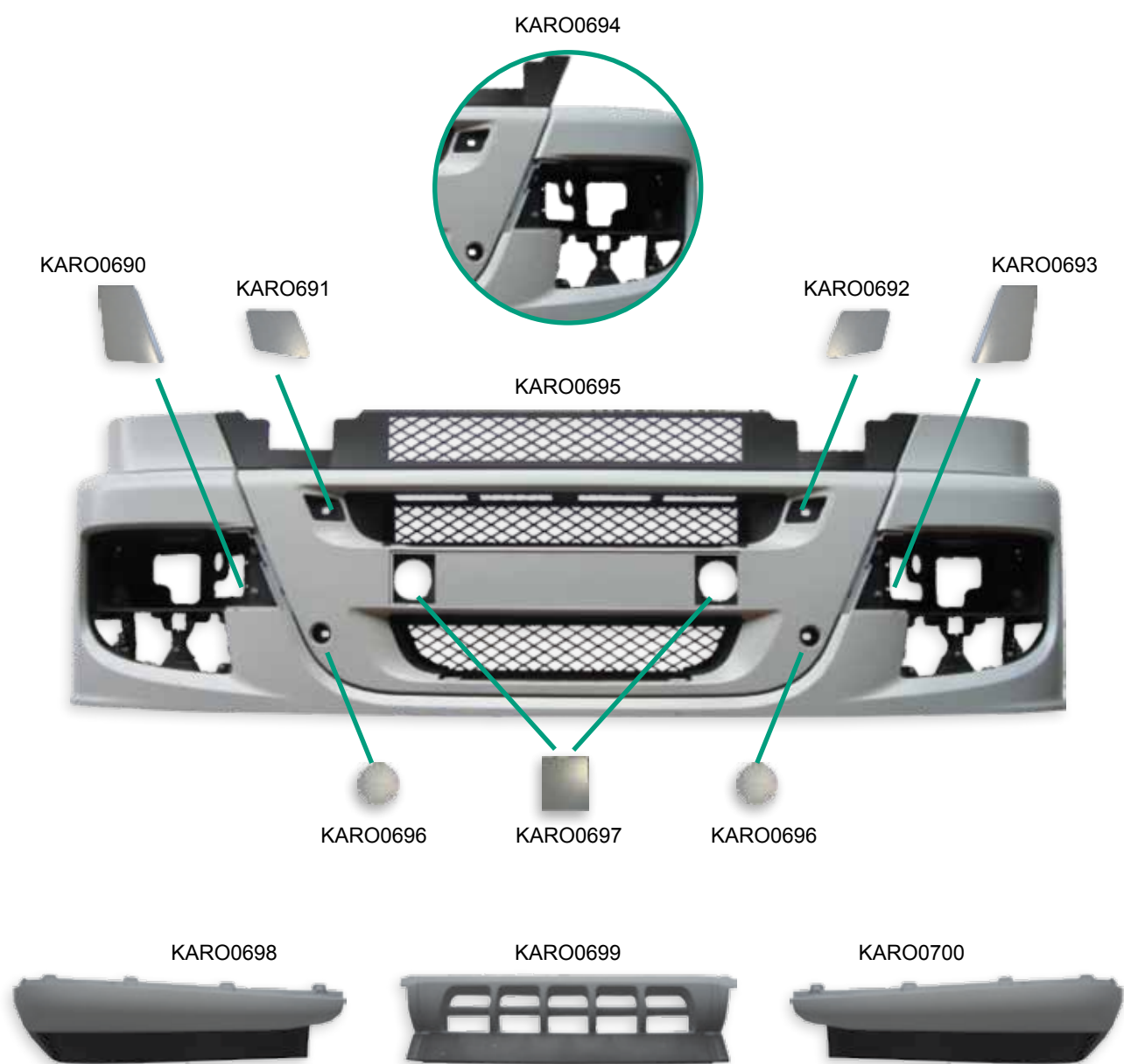

PREĐI NA LISTU UPOREDNIH OE I RAPIDEX BROJEVA - IVECO



PREĐI NA LISTU UPOREDNIH OE I RAPIDEX BROJEVA - IVECO



KARO0706

KARO0707

KARO0705



KARO0708

KARO0709

KARO0710



KARO0711

RASV0337

RASV0335



PREĐI NA LISTU UPOREDNIH OE I RAPIDEX BROJEVA - IVECO



KARO0712

KARO0713



KARO0714

KARO0715



KARO0716



KARO0718

KARO0719



PREĐI NA LISTU UPOREDNIH OE I RAPIDEX BROJEVA - IVECO



KARO0706

KARO0707

KARO0705



KARO0708

KARO0720

KARO0710



KARO0721



RASV0336

RASV0334



PREĐI NA LISTU UPOREDNIH OE I RAPIDEX BROJEVA - IVECO



KARO0722

KARO0723



KARO0724

KARO0725



KARO0726.

KARO0727



KARO0718

KARO0719



PREĐI NA LISTU UPOREDNIH OE I RAPIDEX BROJEVA - IVECO



KARO0728



KARO0729



KARO0730



KARO0731



PREĐI NA LISTU UPOREDNIH OE I RAPIDEX BROJEVA - MAN



KARO0314



KARO0315



KARO0318



KARO0317



KARO0319



KARO0732



KARO0733



KARO0732



KARO0733



KARO0320



KARO0322



KARO0321



PREĐI NA LISTU UPOREDNIH OE I RAPIDEX BROJEVA - MAN

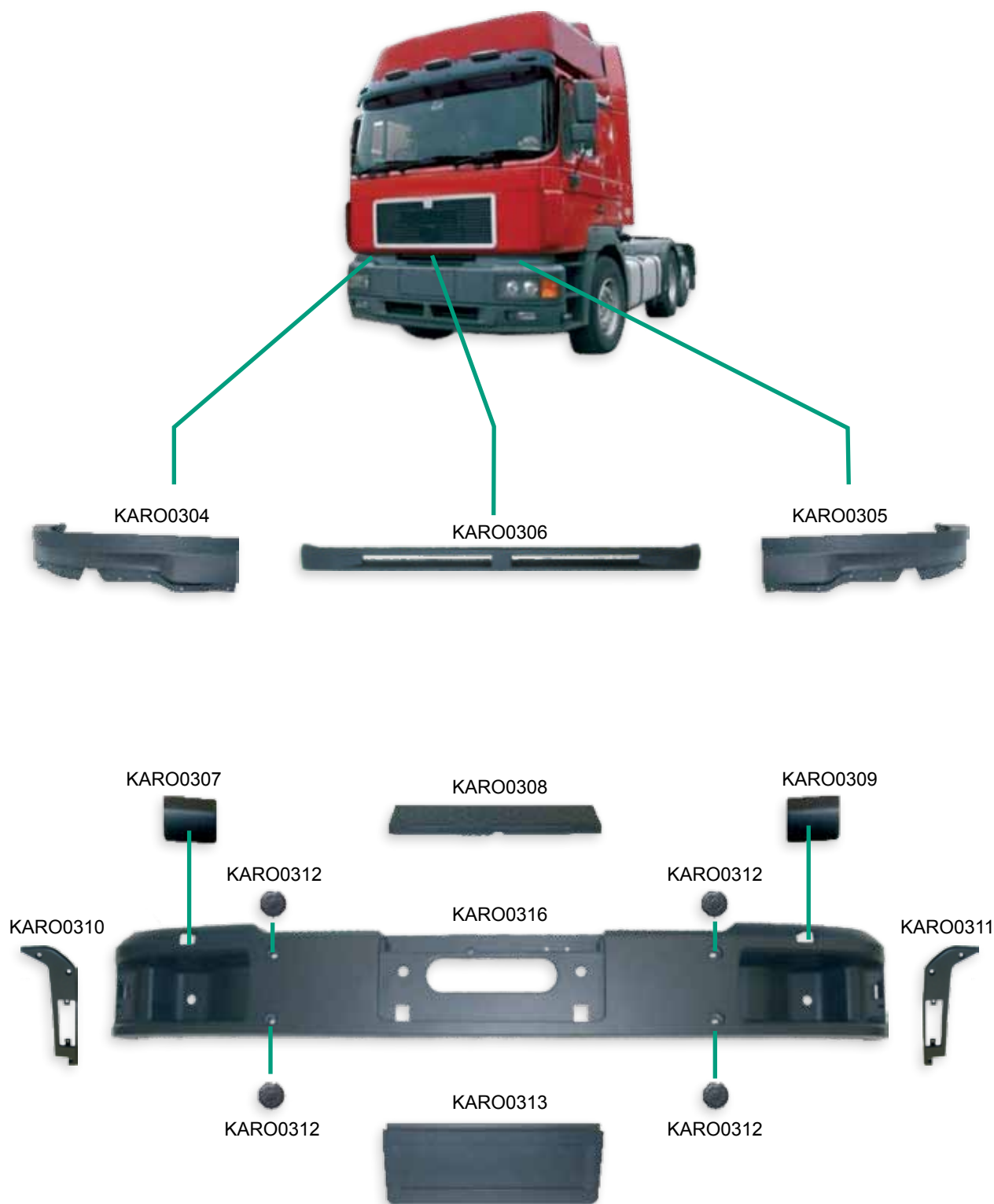

PREĐI NA LISTU UPOREDNIH OE I RAPIDEX BROJEVA - MAN

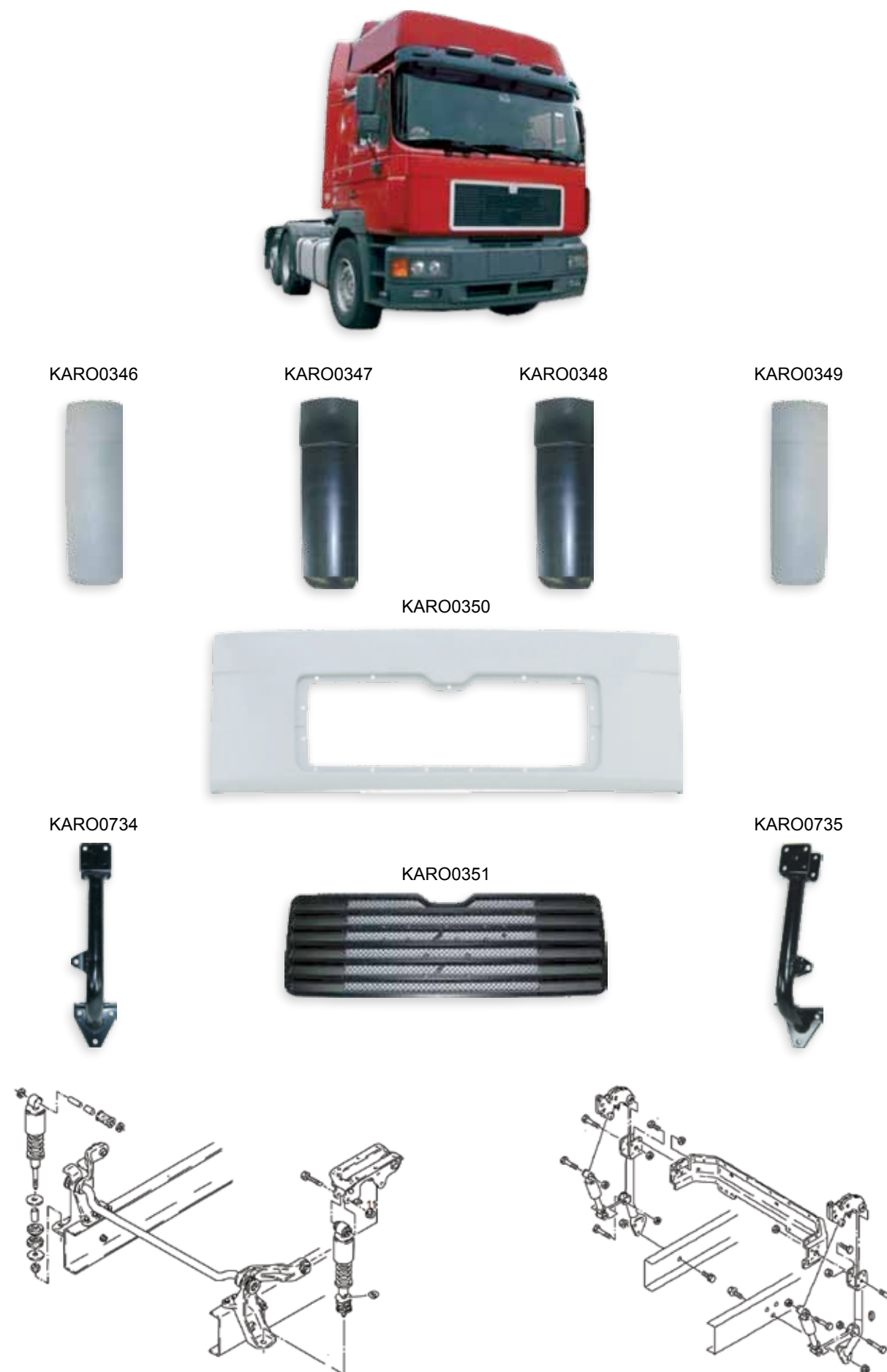

6.1 DELOVI KABINE - MAN F2000

PREĐI NA LISTU UPOREDNIH OE I RAPIDEX BROJEVA - MAN



6.1 DELOVI KABINE - MAN TGA XL, XXL

PREĐI NA LISTU UPOREDNIH OE I RAPIDEX BROJEVA - MAN



PREĐI NA LISTU UPOREDNIH OE I RAPIDEX BROJEVA - MAN

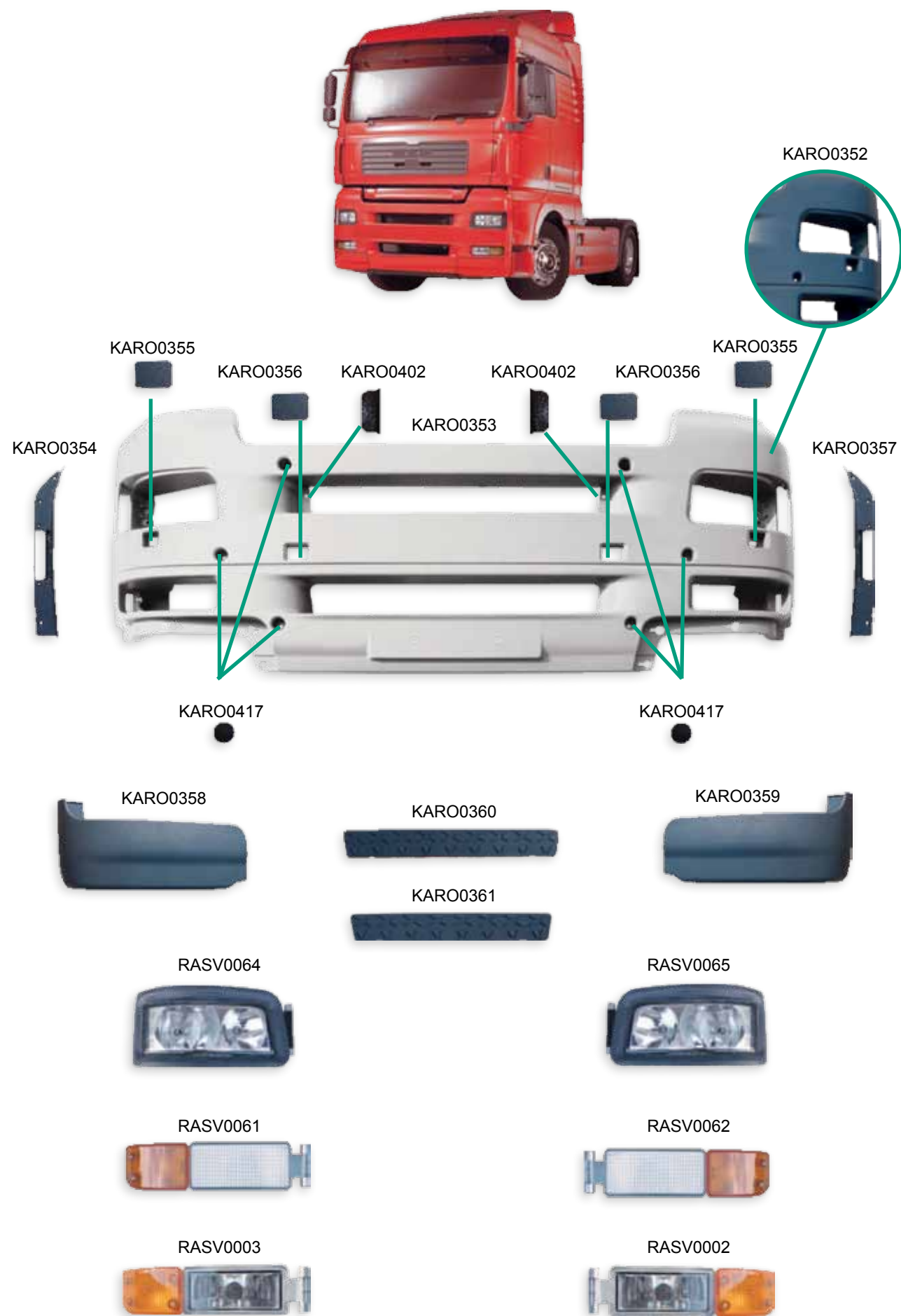

PREĐI NA LISTU UPOREDNIH OE I RAPIDEX BROJEVA - MAN

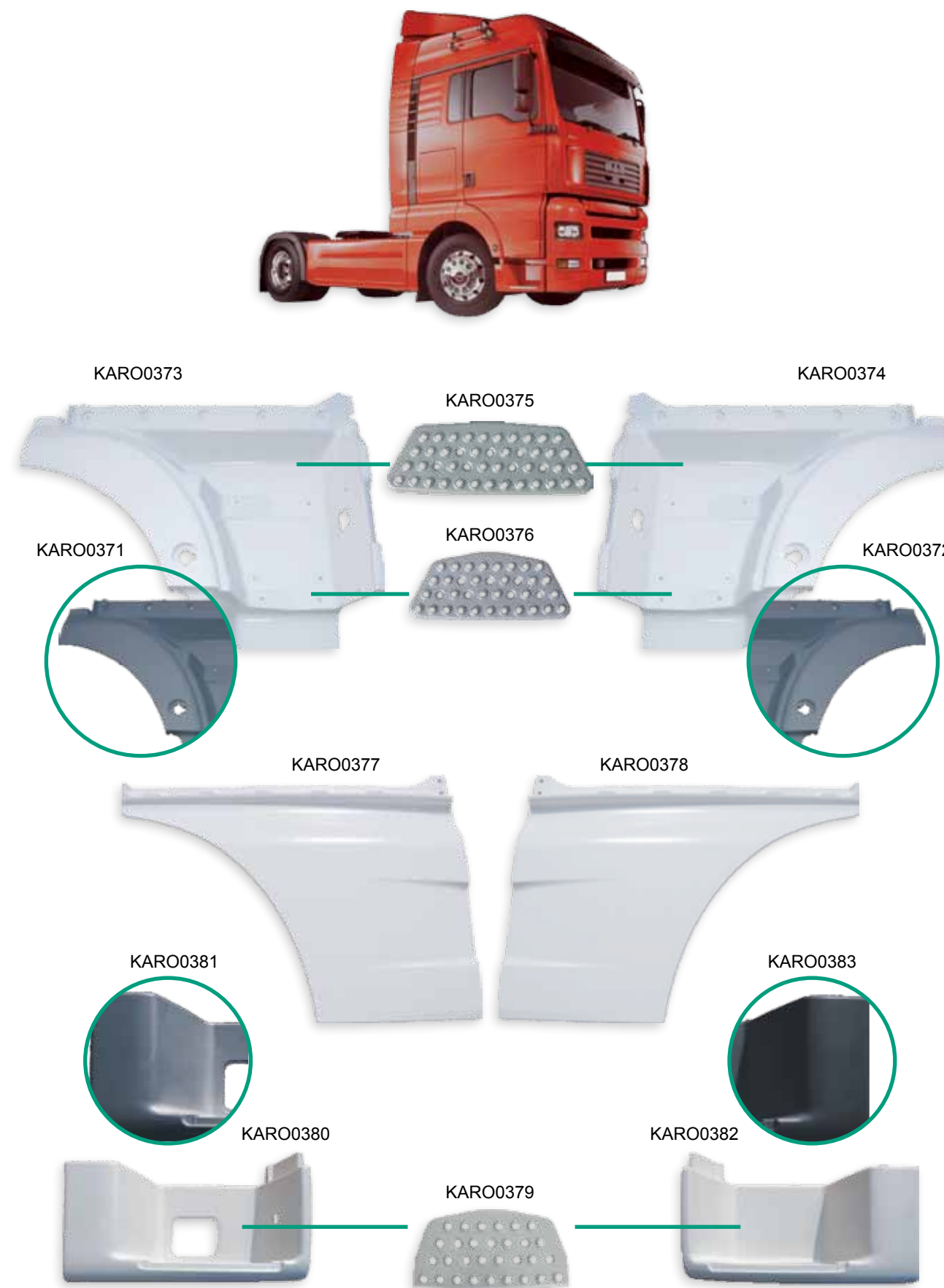

PREĐI NA LISTU UPOREDNIH OE I RAPIDEX BROJEVA - MAN



KARO0384



KARO0385



KARO0386



KARO0388



KARO0387



KARO0737

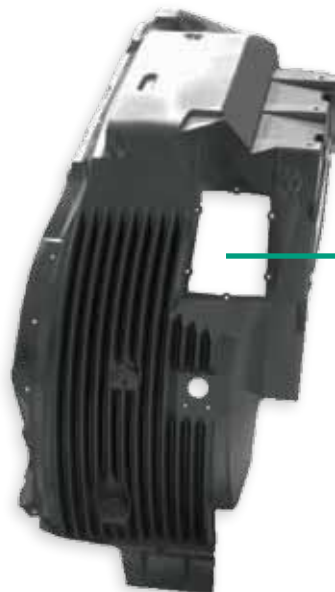

KARO0738

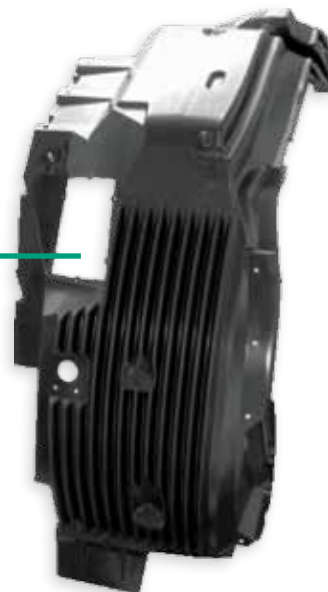

KARO0739



PREĐI NA LISTU UPOREDNIH OE I RAPIDEX BROJEVA - MAN



KARO0437



KARO0391



KARO0439



KARO0410



KARO0864



KARO0411



KARO0740



KARO0741



PREĐI NA LISTU UPOREDNIH OE I RAPIDEX BROJEVA - MAN



KARO0859



KARO0860



KARO0861



KARO0750



KARO0862



KARO0863



KARO0406



KARO0407



PREĐI NA LISTU UPOREDNIH OE I RAPIDEX BROJEVA - MAN



KARO0392

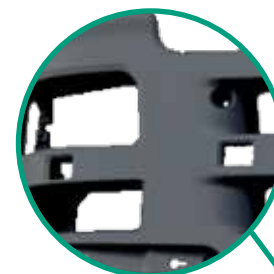

KARO0395



KARO0393



KARO0394



KARO0397



KARO0396



KARO0398



KARO0399



KARO0400



KARO0401



KARO0850



PREĐI NA LISTU UPOREDNIH OE I RAPIDEX BROJEVA - MAN



KARO0742



KARO0745



KARO0746



KARO0747



KARO0748



KARO0743



KARO0744



KARO0750



KARO0749



KARO0751



KARO0752



PREĐI NA LISTU UPOREDNIH OE I RAPIDEX BROJEVA - MAN



KARO0753



KARO0754



KARO0755



KARO0756



KARO0758



KARO0757



KARO0759



KARO0760



KARO0760



PREĐI NA LISTU UPOREDNIH OE I RAPIDEX BROJEVA - MERCEDES



KARO0469



KARO0468



KARO0436



KARO0478



KARO0480



KARO0448



KARO0479



KARO0481



PREĐI NA LISTU UPOREDNIH OE I RAPIDEX BROJEVA - MERCEDES



KARO0482



KARO0483



KARO0484



KARO0485



KARO0453



KARO0452

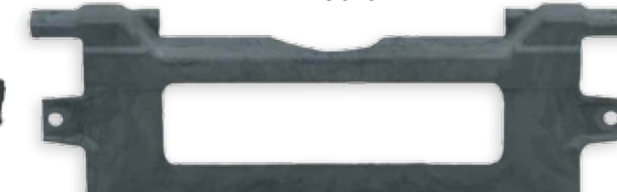

KARO0454



KARO0455



KARO0456



KARO0458



KARO0457



PREĐI NA LISTU UPOREDNIH OE I RAPIDEX BROJEVA - MERCEDES



KARO0459



KARO0460



KARO0461



KARO0462



KARO0463



KARO0464



PREĐI NA LISTU UPOREDNIH OE I RAPIDEX BROJEVA - MERCEDES



KARO0465



KARO0466



KARO0467



KARO0470



KARO0471



KARO0474



KARO0475



6.1 DELOVI KABINE - MERCEDES ACTROS MP1

PREĐI NA LISTU UPOREDNIH OE I RAPIDEX BROJEVA - MERCEDES



KARO0476



KARO0477



KARO0486



KARO0472



KARO0473



KARO0487



KARO0507



KARO0508



KARO0509



KARO0510



6.1 DELOVI KABINE - MERCEDES ACTROS MP2

PREĐI NA LISTU UPOREDNIH OE I RAPIDEX BROJEVA - MERCEDES



KARO0506



KARO0505



KARO0517



KARO0518



KARO0521



KARO0522



KARO0519



KARO0520



PREĐI NA LISTU UPOREDNIH OE I RAPIDEX BROJEVA - MERCEDES



KARO0491



KARO0492



KARO0493



KARO0495



KARO0494



KARO0496



KARO0498



KARO0497



KARO0499



KARO0488



PREĐI NA LISTU UPOREDNIH OE I RAPIDEX BROJEVA - MERCEDES



KARO0490



KARO0489



KARO0501



KARO0500



KARO0502



KARO0514



KARO0515



KARO0516



KARO0513



KARO0511



KARO0512



KARO0503



KARO0504



PREĐI NA LISTU UPOREDNIH OE I RAPIDEX BROJEVA - MERCEDES



KARO0549



KARO0550



KARO0551



KARO0552



KARO0553



KARO0554



KARO0555



KARO0556



PREĐI NA LISTU UPOREDNIH OE I RAPIDEX BROJEVA - MERCEDES



KARO0561



KARO0557



KARO0558



KARO0562



KARO0563

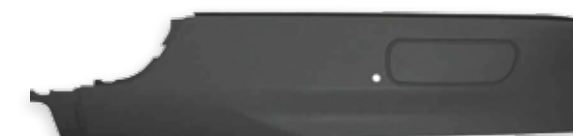

KARO0560



KARO0559



PREĐI NA LISTU UPOREDNIH OE I RAPIDEX BROJEVA - MERCEDES



KARO0534



KARO0535



KARO0536



KARO0538



KARO0537

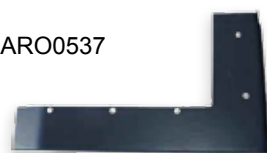

KARO0539



KARO0540

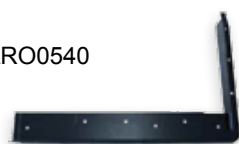

KARO0542



KARO0541



PREĐI NA LISTU UPOREDNIH OE I RAPIDEX BROJEVA - MERCEDES



KARO0543



KARO0545



KARO0544



KARO0546



KARO0548



KARO0547



PREĐI NA LISTU UPOREDNIH OE I RAPIDEX BROJEVA - MERCEDES



KARO0525



KARO0526



KARO0527



KARO0528



KARO0529

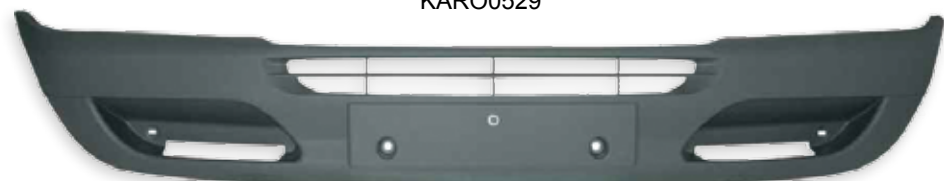

PREĐI NA LISTU UPOREDNIH OE I RAPIDEX BROJEVA - MERCEDES



KARO0530



KARO0531



KARO0532



KARO0533



PREĐI NA LISTU UPOREDNIH OE I RAPIDEX BROJEVA - RENAULT



KARO0761



KARO0001



KARO0002



KARO0003



KARO0762



KARO0762



KARO0763



PREĐI NA LISTU UPOREDNIH OE I RAPIDEX BROJEVA - RENAULT



KARO0418

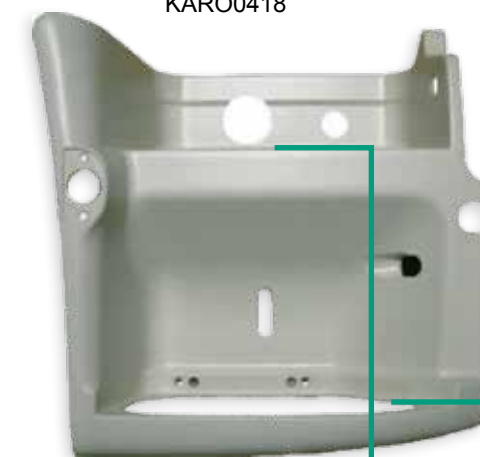

KARO0004



KARO0764



KARO0005



KARO0765



KARO0006



PREĐI NA LISTU UPOREDNIH OE I RAPIDEX BROJEVA - RENAULT



KARO0766

KARO0768

KARO0767



KARO0769



KARO0770

KARO0771

KARO0771

KARO0770



PREĐI NA LISTU UPOREDNIH OE I RAPIDEX BROJEVA - RENAULT



KARO0772

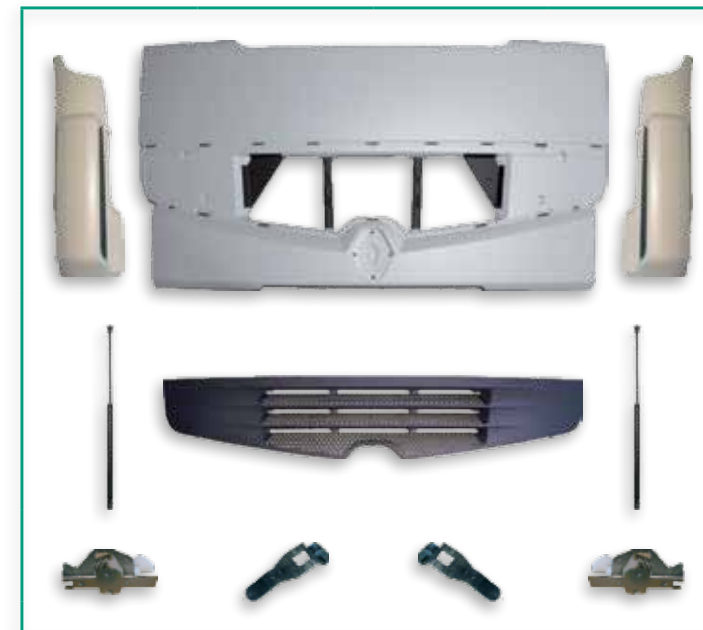

KARO0773

KARO0774



KARO0775

KARO0007



PREĐI NA LISTU UPOREDNIH OE I RAPIDEX BROJEVA - RENAULT



KARO0776



KARO0008



KARO0009



KARO0009



KARO0777



KARO0778



KARO0779



KARO0780



PREĐI NA LISTU UPOREDNIH OE I RAPIDEX BROJEVA - RENAULT



KARO0781



KARO0782



KARO0213



KARO0783



KARO0784



KARO0785



KARO0786



PREĐI NA LISTU UPOREDNIH OE I RAPIDEX BROJEVA - RENAULT



KARO0787



KARO0788



KARO0765



KARO0006



KARO0789



KARO0790



PREĐI NA LISTU UPOREDNIH OE I RAPIDEX BROJEVA - RENAULT



KARO0791



KARO0792



KARO0793



PREĐI NA LISTU UPOREDNIH OE I RAPIDEX BROJEVA - SCANIA



KARO0224

KARO0226

KARO0225

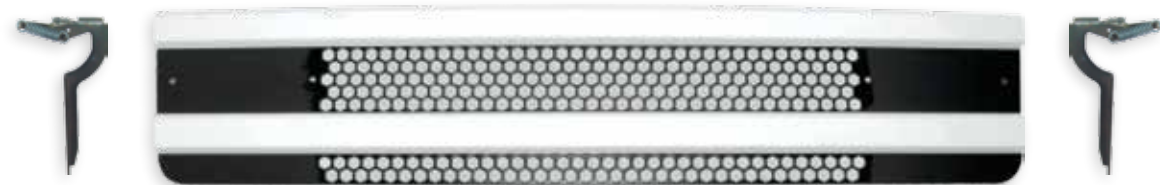

KARO0222

KARO0223

RASV0063

RASV0019



RASV0348

RASV0286



KARO0227

KARO0228

KARO0229



PREĐI NA LISTU UPOREDNIH OE I RAPIDEX BROJEVA - SCANIA



KARO0282

KARO0283

KARO0231

KARO0232

KARO0235

KARO0236

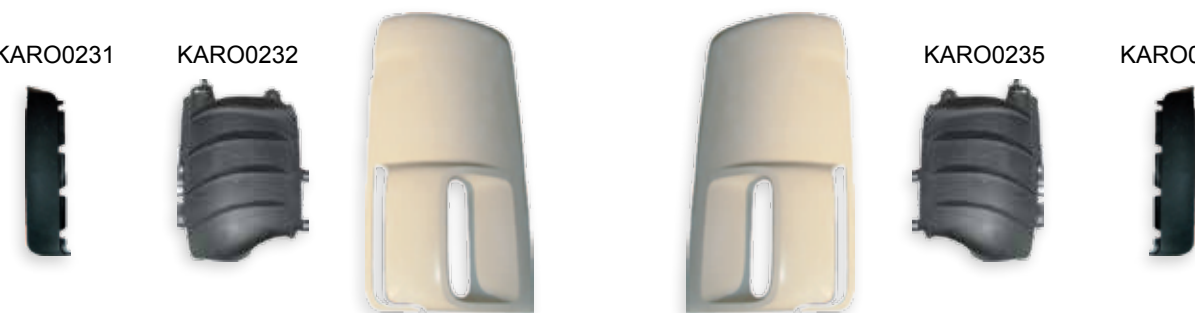

KARO0237



KARO0238



KARO0233

KARO0243



KARO0240



KARO0241



KARO0242



KARO0239

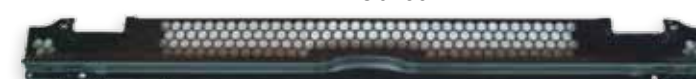

PREĐI NA LISTU UPOREDNIH OE I RAPIDEX BROJEVA - SCANIA

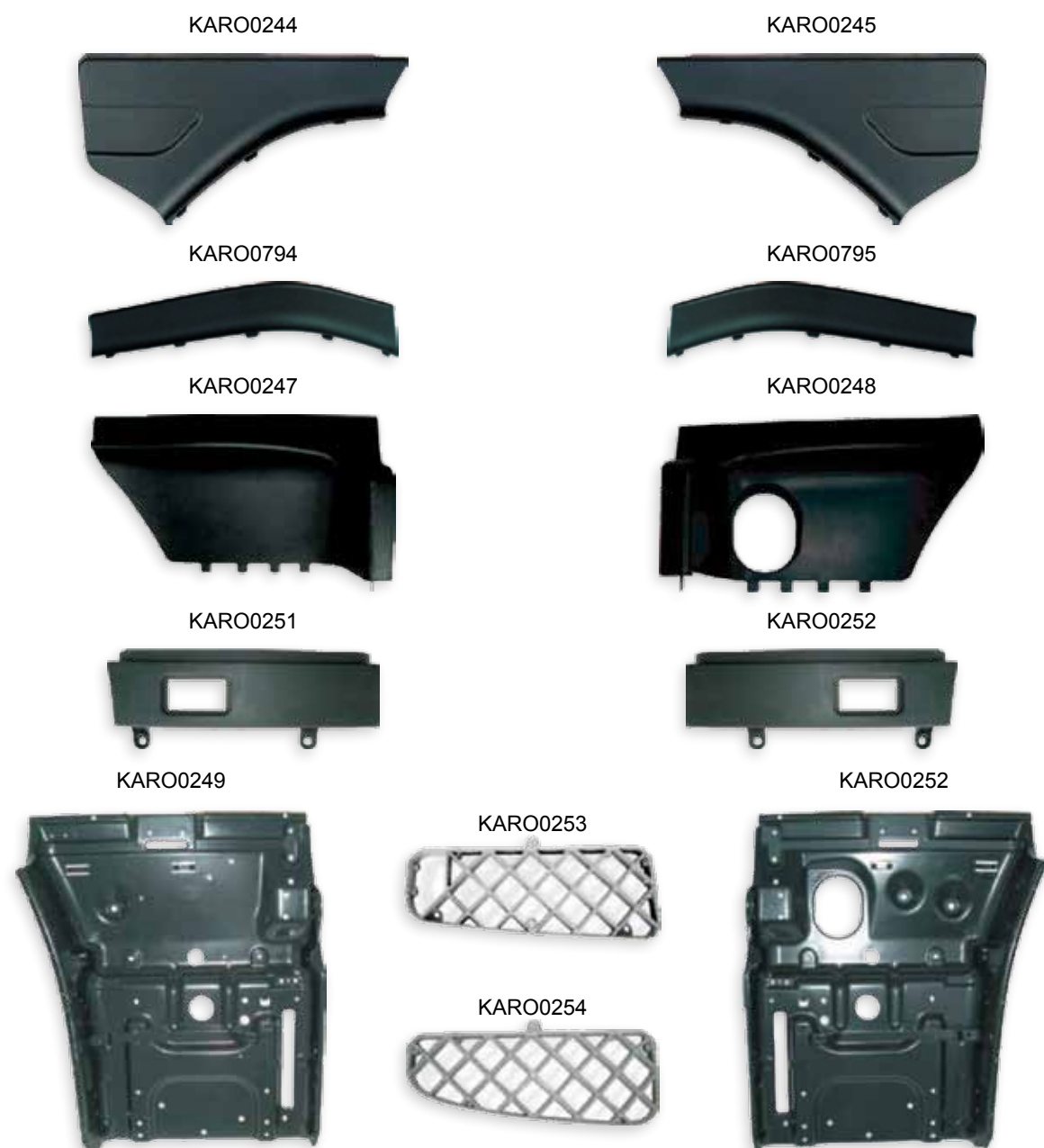

PREĐI NA LISTU UPOREDNIH OE I RAPIDEX BROJEVA - SCANIA

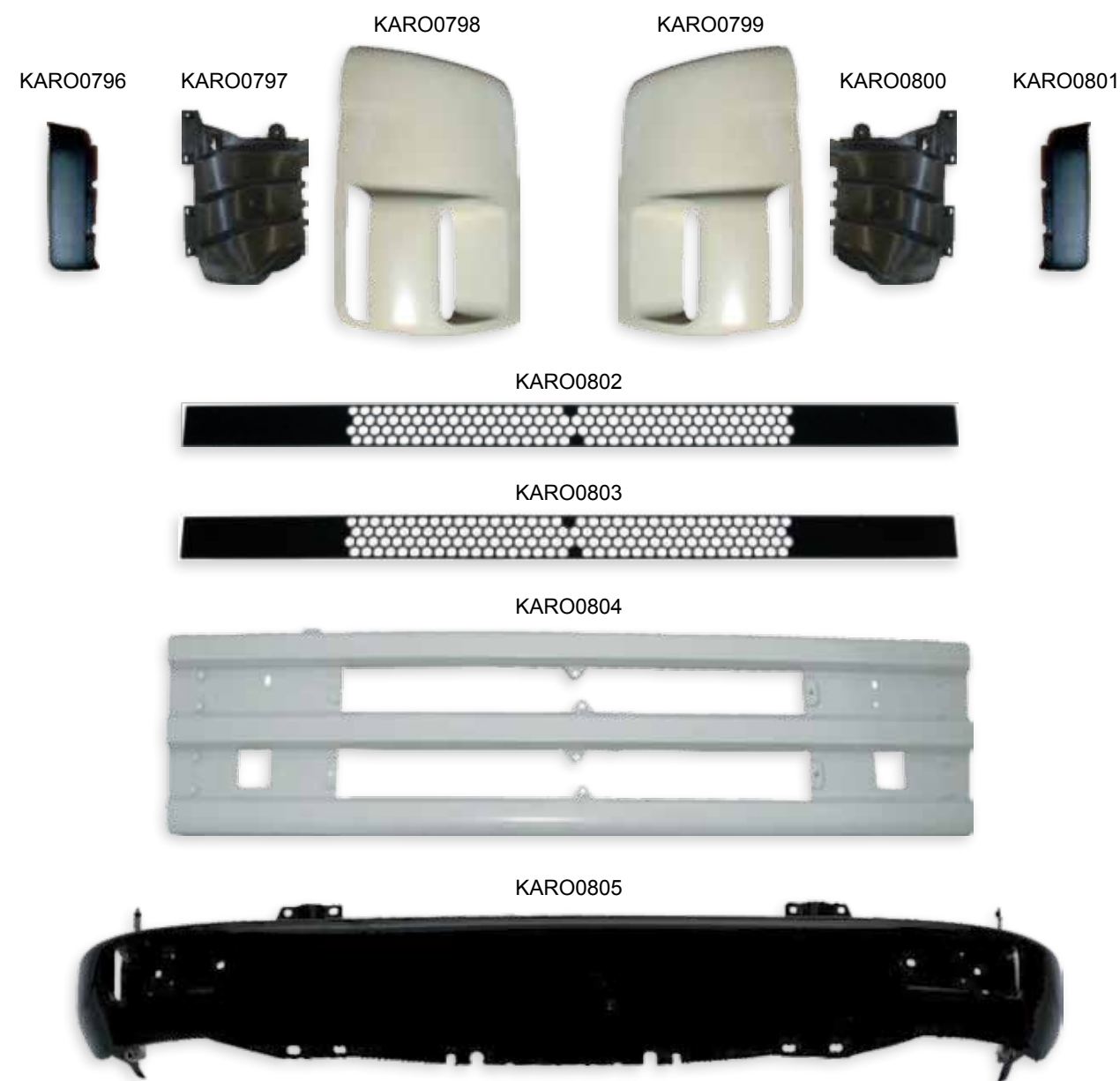

PREĐI NA LISTU UPOREDNIH OE I RAPIDEX BROJEVA - SCANIA



KARO0261
PREDNJI DESNI - ZADNJI LEVI



KARO0262
PREDNJI LEVI - ZADNJI DESNI



KARO0806



KARO0807



KARO0808



KARO0255



KARO0809



KARO0256



SVI DELOVI SU UGRADLJIVI U SERIJE L I R

PREĐI NA LISTU UPOREDNIH OE I RAPIDEX BROJEVA - SCANIA



KARO0258



KARO0259



KARO0263



KARO0260



KARO0264



SVI DELOVI SU UGRADLJIVI U SERIJE L I R

6.1 DELOVI KABINE - SCANIA LR CP CR

PREĐI NA LISTU UPOREDNIH OE I RAPIDEX BROJEVA - SCANIA



KARO0810



KARO0257



6.1 DELOVI KABINE - SCANIA R CR

PREĐI NA LISTU UPOREDNIH OE I RAPIDEX BROJEVA - SCANIA



KARO0278



KARO0279



KARO0280*



KARO0281*



KARO0275*



KARO0276*



KARO0811



KARO0277*



KARO0812



* ODGOVARA ZA SERIJU R CP KABINA

PREĐI NA LISTU UPOREDNIH OE I RAPIDEX BROJEVA - SCANIA



PREĐI NA LISTU UPOREDNIH OE I RAPIDEX BROJEVA - SCANIA



PREĐI NA LISTU UPOREDNIH OE I RAPIDEX BROJEVA - SCANIA



PREĐI NA LISTU UPOREDNIH OE I RAPIDEX BROJEVA - SCANIA



PREĐI NA LISTU UPOREDNIH OE I RAPIDEX BROJEVA - SCANIA



KARO0827



KARO0828



KARO0829



KARO0830



KARO0831



KARO0832



KARO0833



PREĐI NA LISTU UPOREDNIH OE I RAPIDEX BROJEVA - SCANIA



KARO0834



KARO0835



KARO0836



KARO0837



KARO0269



KARO0270



KARO0838



PREĐI NA LISTU UPOREDNIH OE I RAPIDEX BROJEVA - VOLVO



KARO0145



KARO0839



KARO0146



KARO0147



KARO0143



KARO0141



KARO0142



KARO0144



RASV0259



RASV0290



RASV0290



RASV0259



RASV0322



RASV0321



PREĐI NA LISTU UPOREDNIH OE I RAPIDEX BROJEVA - VOLVO



KARO0150



KARO0151



KARO0148



KARO0149



KARO0152



KARO0153



PREĐI NA LISTU UPOREDNIH OE I RAPIDEX BROJEVA - VOLVO

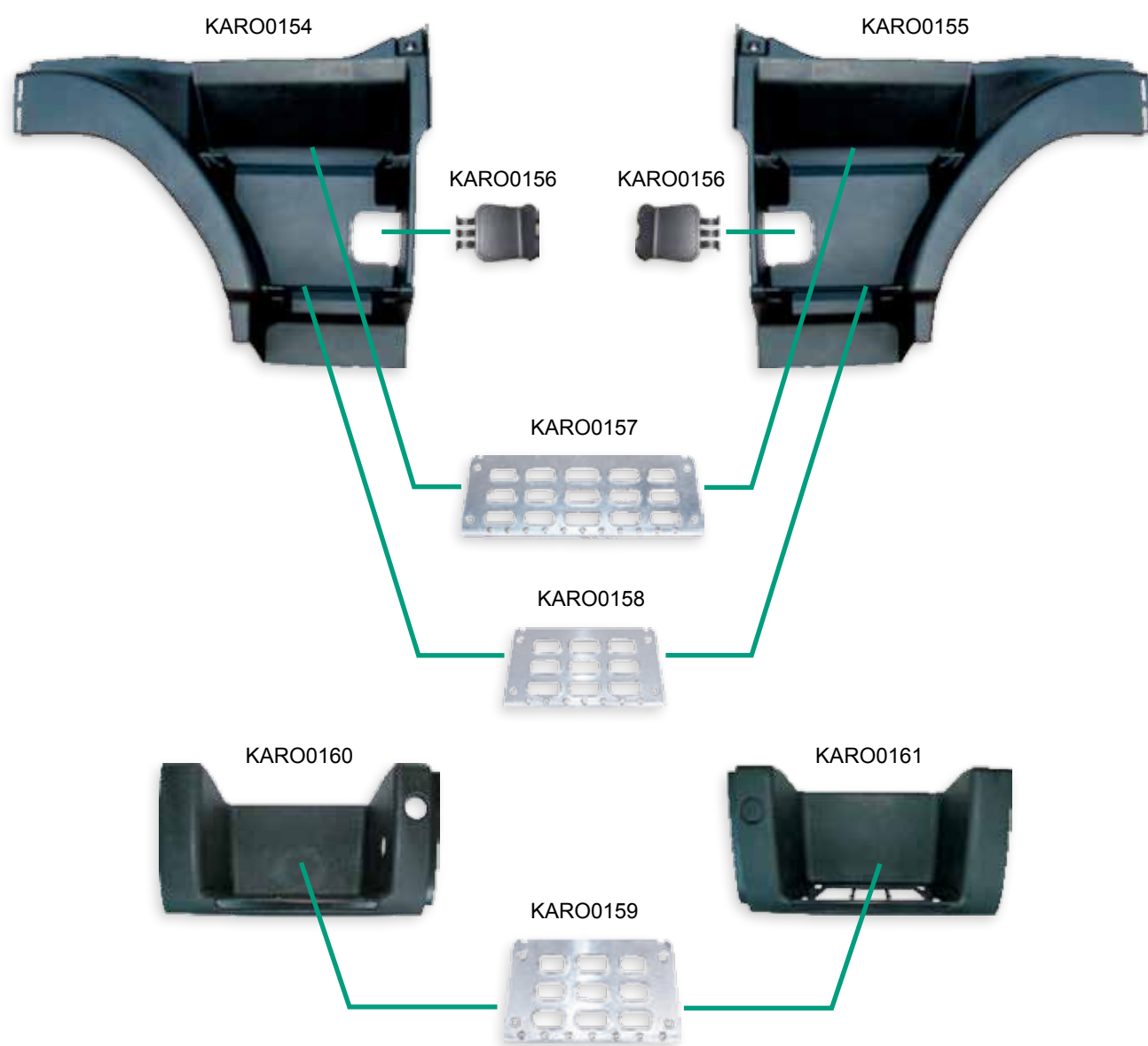

PREĐI NA LISTU UPOREDNIH OE I RAPIDEX BROJEVA - VOLVO



PREĐI NA LISTU UPOREDNIH OE I RAPIDEX BROJEVA - VOLVO

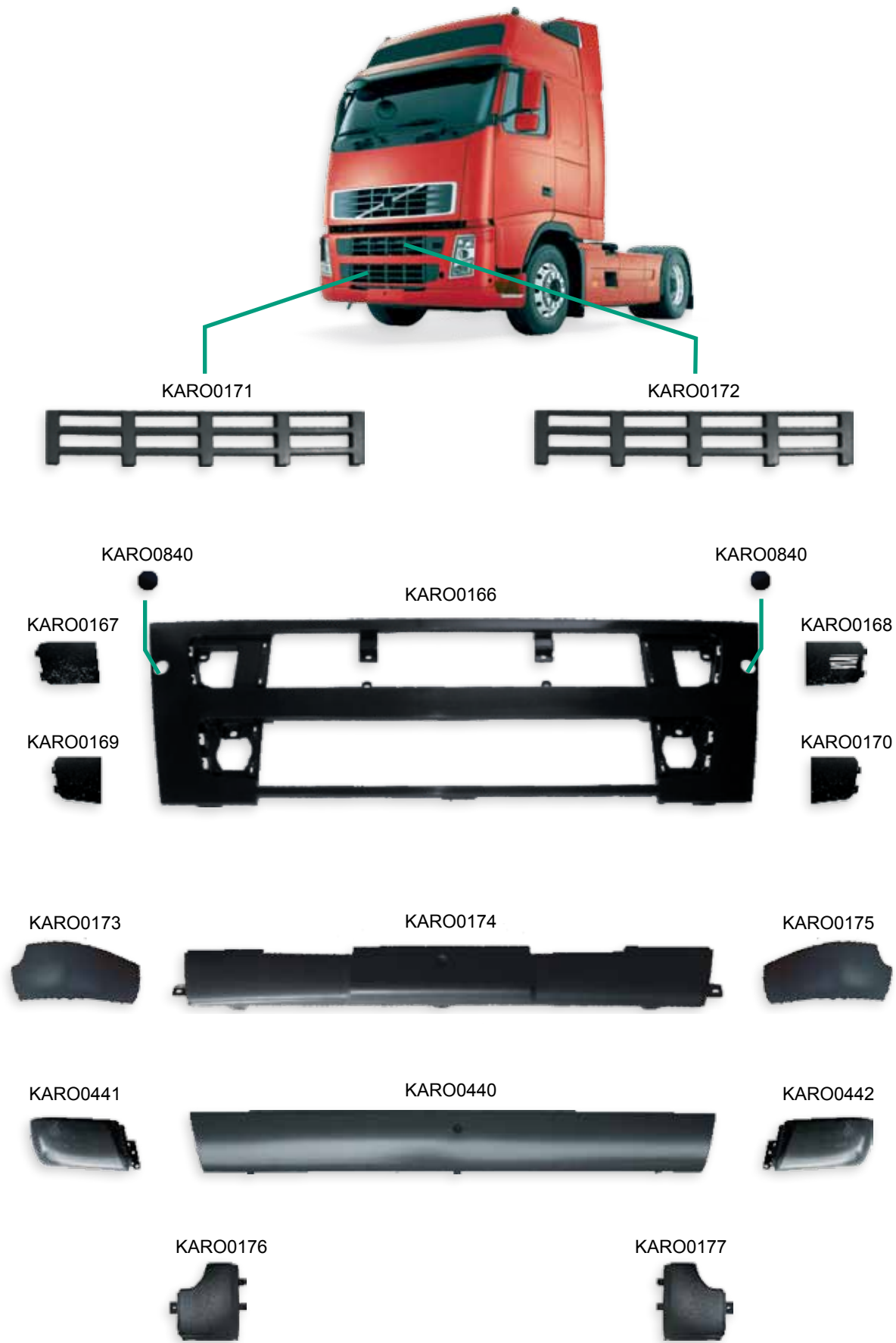

PREĐI NA LISTU UPOREDNIH OE I RAPIDEX BROJEVA - VOLVO



PREĐI NA LISTU UPOREDNIH OE I RAPIDEX BROJEVA - VOLVO



RASV0320



RASV0319



RASV0386



RASV0385



RASV0076



RASV0077



KARO0184



KARO0185



KARO0186



KARO0187



KARO0188



KARO0189



KARO0190



KARO0191



KARO0193



KARO0192



PREĐI NA LISTU UPOREDNIH OE I RAPIDEX BROJEVA - VOLVO



KARO0209



KARO0581



KARO0213



KARO0214



KARO0210



KARO0573



KARO0783



KARO0786



KARO0445



KARO0843



KARO0211



PREĐI NA LISTU UPOREDNIH OE I RAPIDEX BROJEVA - VOLVO

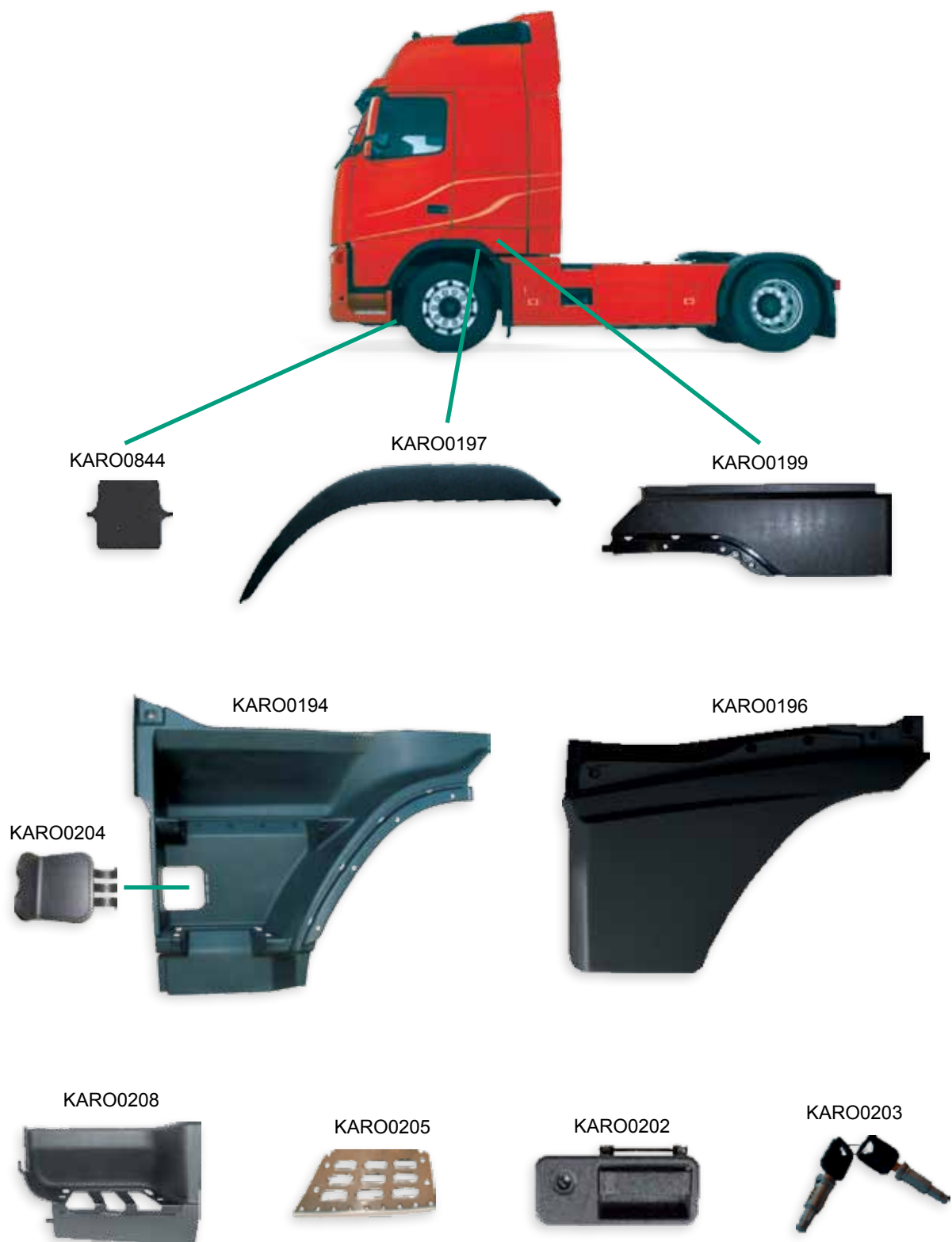

PREĐI NA LISTU UPOREDNIH OE I RAPIDEX BROJEVA - VOLVO

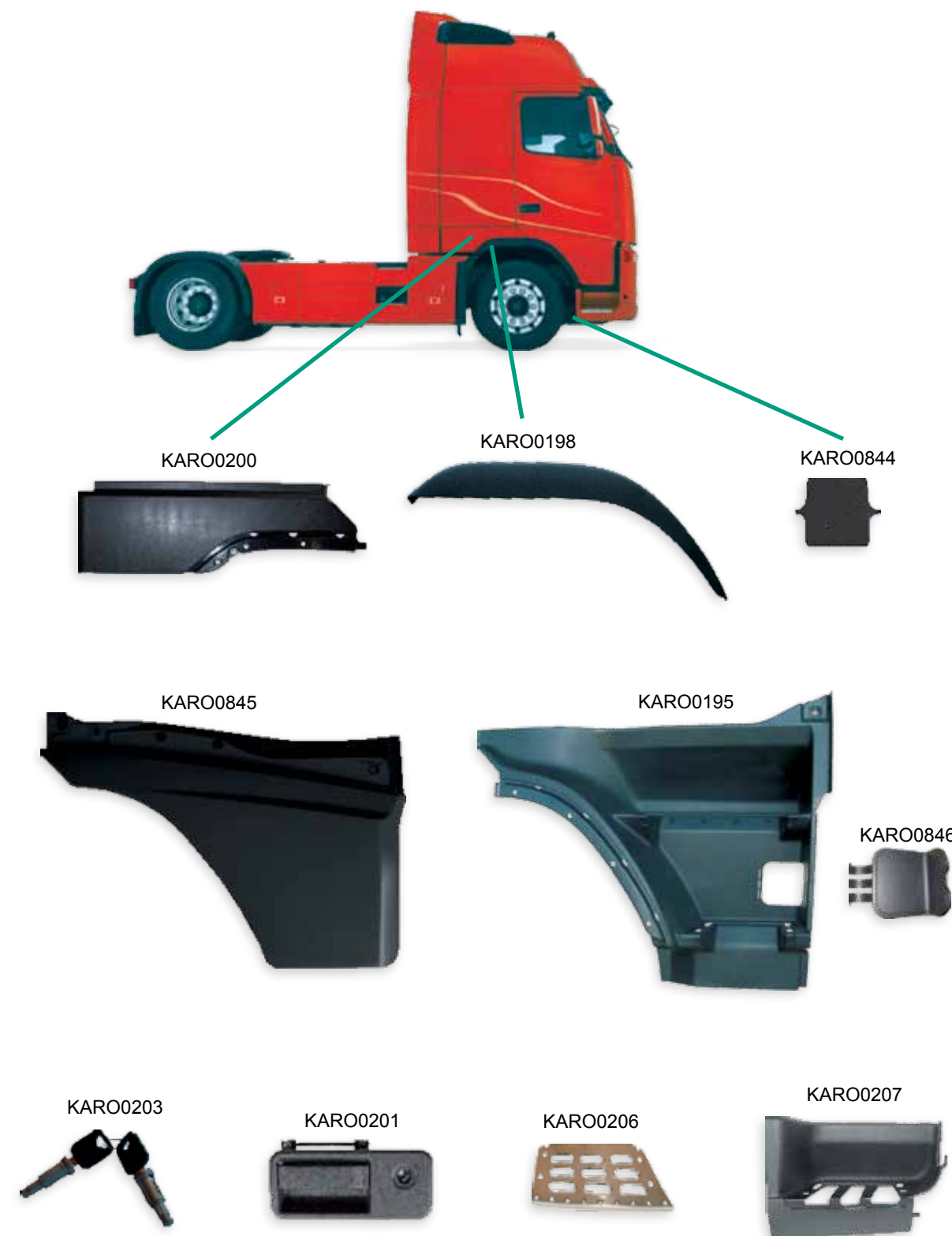

PREĐI NA LISTU UPOREDNIH OE I RAPIDEX BROJEVA - VOLVO



BLATOBRA NI			
Slika	Poz.	Dimenzije (mm)	RAPIDEX broj
	1.	450 x (1300/1400)	KARO0865
	2.	455 x (2090/2290)	KARO0866
	3.	680 x (1650/1800/2175)	KARO0867
	4.	450 x 1300	KARO0868
	5.	450 x 1770	KARO0869
	6.	650 x 2310	KARO0870
	7.	650 x 2340	KARO0871
	8.	440 x 1700 + 1000	KARO0872
	9.	650 x 1700 + 900	KARO0873
	10.	435 x 1900	KARO0874
	11.	435 x 2100	KARO0875
	12.	650 x 1840	KARO0876
	13.	650 x 2090	KARO0877
	14.	670 x 2125	KARO0878

LISTA UPOREDNIH OE I RAPIDEX BROJEVA - DAF

1.	0083117	KARO0078	31.	1336467	KARO0132
2.	0083118	KARO0077	32.	1336468	KARO0133
3.	673143	KARO0115	33.	1340450	KARO0084
4.	673144	KARO0114	34.	1347131	KARO0117
5.	750899	KARO0071	35.	1347132	KARO0116
6.	0948779	KARO0104	36.	1362870	KARO0065
7.	962101	KARO0072	37.	1362871	KARO0066
8.	0962643	KARO0120	38.	1363370	KARO0068
9.	1290191	KARO0099	39.	1363373	KARO0059
10.	1291164	KARO0135	40.	1363374	KARO0058
11.	1291165	KARO0134	41.	1363375	KARO0062
12.	1291168	KARO0665	42.	1363820	KARO0658
13.	1291169	KARO0664	43.	1363820	KARO0659
14.	1291172	KARO0111	44.	1364798	KARO0074
15.	1291173	KARO0110	45.	1364799	KARO0073
16.	1294284	KARO0661	46.	1372532	KARO0064
17.	1294285	KARO0660	47.	1372533	KARO0063
18.	1294948	KARO0097	48.	1372534	KARO0657
19.	1294949	KARO0096	49.	1372535	KARO0654
20.	1295619	KARO0113	50.	1372536	KARO0655
21.	1295620	KARO0112	51.	1372537	KARO0656
22.	1295732	KARO0119	52.	1385178	KARO0653
23.	1295735	KARO0118	53.	1385179	KARO0652
24.	1309112	KARO0131	54.	1389296	KARO0082
25.	1309113	KARO0130	55.	1389296	KARO0667
26.	1312789	KARO0129	56.	1389297	KARO0081
27.	1319678	KARO0103	57.	1389297	KARO0666
28.	1319679	KARO0105	58.	1393645	KARO0079
29.	1328934	KARO0085	59.	1393646	KARO0080
30.	1328935	KARO0086	60.	1393653	KARO0663

LISTA UPOREDNIH OE I RAPIDEX BROJEVA - DAF

61.	1393654	KARO0662	75.	1605932	KARO0122
62.	1398284	KARO0109	76.	1605933	KARO0121
63.	1398285	KARO0108	77.	1634640	KARO0136
64.	1400011	KARO0126	78.	1635802	KARO0670
65.	1400012	KARO0124	79.	1638480	KARO0076
66.	1400013	KARO0128	80.	1638481	KARO0075
67.	1400014	KARO0127	81.	1641630	KARO0669
68.	1427140	KARO0098	82.	1641631	KARO0668
69.	1437809	KARO0070	83.	1642682	KARO0140
70.	1437810	KARO0069	84.	1642683	KARO0139
71.	1438573	KARO0061	85.	1683721	KARO0138
72.	1438577	KARO0060	86.	1683722	KARO0435
73.	1450976	KARO0107	87.	1699468	KARO0067
74.	1450977	KARO0102			

LISTA UPOREDNIH OE I RAPIDEX BROJEVA - IVECO

1.	41002409	KARO0051	15.	500380111	KARO0046
2.	41002927	KARO0049	16.	500383947	KARO0029
3.	41003236	KARO0048	17.	500398112	KARO0010
4.	41016244	KARO0050	18.	504001344	KARO0025
5.	41016379	KARO0052	19.	504001344	KARO0685
6.	41032399	KARO0053	20.	504001345	KARO0684
7.	41032403	KARO0055	21.	504001358	KARO0683
8.	41032407	KARO0057	22.	504001358	KARO0024
9.	41210252	KARO0054	23.	504001361	KARO0682
10.	41210255	KARO0056	24.	504001361	KARO0022
11.	41213750	KARO0677	25.	504003992	KARO0040
12.	41221029	KARO0033	26.	504003992	KARO0676
13.	41221039	KARO0034	27.	504003993	KARO0675
14.	41213750	KARO0047	28.	504003993	KARO0041

LISTA UPOREDNIH OE I RAPIDEX BROJEVA - IVECO

29.	504004279	KARO0042	59.	504052237	KARO0715
30.	504004280	KARO0043	60.	504054940	KARO0722
31.	504005685	KARO0044	61.	504054941	KARO0723
32.	504005687	KARO0045	62.	504054942	KARO0724
33.	504016309	KARO0032	63.	504054943	KARO0725
34.	504022497	KARO0678	64.	504054989	KARO0728
35.	504022498	KARO0679	65.	504054990	KARO0729
36.	504022499	KARO0681	66.	504055010	KARO0730
37.	504022500	KARO0680	67.	504055011	KARO0731
38.	504027461	KARO0707	68.	504055140	KARO0726
39.	504027536	KARO0716	69.	504055141	KARO0727
40.	504027537	KARO0717	70.	504056033	KARO0686
41.	504027613	KARO0711	71.	504056033	KARO0026
42.	504027614	KARO0709	72.	504056034	KARO0687
43.	504037735	KARO0712	73.	504056034	KARO0027
44.	504037737	KARO0713	74.	504056436	KARO0028
45.	504041243	KARO0037	75.	504060280	KARO0706
46.	504044980	KARO0673	76.	504060281	KARO0705
47.	504044981	KARO0674	77.	504065980	KARO0036
48.	504045193	KARO0672	78.	504065981	KARO0035
49.	504045194	KARO0671	79.	504116080	KARO0708
50.	504047583	KARO0039	80.	504116081	KARO0710
51.	504047584	KARO0038	81.	504139860	KARO0718
52.	504047585	KARO0031	82.	504139861	KARO0719
53.	504047585	KARO0689	83.	504173477	KARO0704
54.	504047586	KARO0030	84.	504173478	KARO0703
55.	504047586	KARO0688	85.	504187294	KARO0697
56.	504049813	KARO0721	86.	504187339	KARO0696
57.	504049814	KARO0720	87.	504187426	KARO0691
58.	504052236	KARO0714	88.	504187427	KARO0692

LISTA UPOREDNIH OE I RAPIDEX BROJEVA - IVECO

89.	504187506	KARO0690	102.	500375473	KARO0018
90.	504187507	KARO0693	103.	500383947	KARO0443
91.	504188129	KARO0701	104.	500398112	KARO0446
92.	504188130	KARO0702	105.	504001345	KARO0023
93.	504190697	KARO0699	106.	504001361	KARO0433
94.	504190780	KARO0698	107.	504036807	KARO0011
95.	504190781	KARO0700	108.	504036808	KARO0012
96.	504284315	KARO0695	109.	504047586	KARO0434
97.	504284316	KARO0694	110.	504065982	KARO0017
98.	500364901	KARO0013	111.	504065984	KARO0015
99.	500375430	KARO0021	112.	504065985	KARO0014
100.	500375431	KARO0020	113.	504074676	KARO0016
101.	500375472	KARO0019			

LISTA UPOREDNIH OE I RAPIDEX BROJEVA - MAN

1.	81.06102.6113	KARO0312	16.	81.41610.0230	KARO0395
2.	81.41610.0150	KARO0313	17.	81.41610.0231	KARO0357
3.	81.41610.0151	KARO0311	18.	81.41610.0232	KARO0354
4.	81.41610.0152	KARO0310	19.	81.41610.0305	KARO0353
5.	81.41610.0158	KARO0307	20.	81.41610.0306	KARO0352
6.	81.41610.0159	KARO0309	21.	81.41610.0307	KARO0393
7.	81.41610.0164	KARO0306	22.	81.41610.0308	KARO0392
8.	81.41610.0166	KARO0304	23.	81.41610.0361	KARO0742
9.	81.41610.0167	KARO0305	24.	81.41610.0363	KARO0754
10.	81.41610.0191	KARO0308	25.	81.41610.2881	KARO0361
11.	81.41610.0225	KARO0396	26.	81.41610.2882	KARO0360
12.	81.41610.0226	KARO0397	27.	81.41610.4114	KARO0316
13.	81.41610.0227	KARO0359	28.	81.41613.0066	KARO0732
14.	81.41610.0228	KARO0358	29.	81.41613.0069	KARO0733
15.	81.41610.0229	KARO0394	30.	81.41613.0071	KARO0317

PREĐI NA DELOVI KABINE - MAN

LISTA UPOREDNIH OE I RAPIDEX BROJEVA - MAN

31.	81.41613.0073	KARO0322	61.	81.61230.0067	KARO0330
32.	81.41613.0078	KARO0320	62.	81.61230.0108	KARO0739
33.	81.41613.0079	KARO0321	63.	81.61230.0209	KARO0738
34.	81.41613.0080	KARO0318	64.	81.61230.0210	KARO0737
35.	81.41613.0081	KARO0319	65.	81.61510.0225	KARO0334
36.	81.41613.5035	KARO0315	66.	81.61510.0226	KARO0333
37.	81.41614.0023	KARO0743	67.	81.61510.0229	KARO0345
38.	81.41614.0024	KARO0744	68.	81.61510.0230	KARO0344
39.	81.41614.0025	KARO0755	69.	81.61510.0262	KARO0339
40.	81.41614.0026	KARO0756	70.	81.61510.0263	KARO0340
41.	81.41615.5061	KARO0314	71.	81.61510.0267	KARO0338
42.	81.41685.0031	KARO0356	72.	81.61510.0268	KARO0337
43.	81.41685.0040	KARO0355	73.	81.61510.0273	KARO0375
44.	81.41685.0053	KARO0370	74.	81.61510.0288	KARO0747
45.	81.41685.0061	KARO0736	75.	81.61510.0333	KARO0382
46.	81.41701.5344	KARO0734	76.	81.61510.0351	KARO0399
47.	81.41701.5345	KARO0735	77.	81.61510.0351	KARO0383
48.	81.41860.0058	KARO0412	78.	81.61510.0366	KARO0405
49.	81.41860.0144	KARO0864	79.	81.61510.0368	KARO0745
50.	81.61110.0044	KARO0350	80.	81.61510.0374	KARO0380
51.	81.61110.6041	KARO0753	81.	81.61510.0380	KARO0398
52.	81.61150.5060	KARO0351	82.	81.61510.0380	KARO0381
53.	81.61150.6050	KARO0367	83.	81.61510.0399	KARO0372
54.	81.61210.0462	KARO0388	84.	81.61510.0400	KARO0371
55.	81.61210.5363	KARO0327	85.	81.61510.0401	KARO0374
56.	81.61210.5363	KARO0419	86.	81.61510.0402	KARO0373
57.	81.61210.5364	KARO0326	87.	81.61510.0410	KARO0384
58.	81.61210.0620	KARO0859	88.	81.61510.0411	KARO0385
59.	81.61210.0621	KARO0860	89.	81.61510.0421	KARO0376
60.	81.61230.0066	KARO0329	90.	81.61510.0472	KARO0749

PREĐI NA DELOVI KABINE - MAN

LISTA UPOREDNIH OE I RAPIDEX BROJEVA - MAN

91.	81.61510.0473	KARO0750	121.	81.62440.0039	KARO0369
92.	81.61510.0474	KARO0409	122.	81.62440.0041	KARO0368
93.	81.61510.0474	KARO0861	123.	81.62610.0023	KARO0378
94.	81.61510.0475	KARO0408	124.	81.62610.0024	KARO0377
95.	81.61510.0552	KARO0748	125.	81.62610.0032	KARO0406
96.	81.61510.0554	KARO0404	126.	81.62610.0033	KARO0407
97.	81.61510.0555	KARO0746	127.	81.66410.0226	KARO0390
98.	81.61510.0739	KARO0752	128.	81.66410.0226	KARO0439
99.	81.61510.0740	KARO0751	129.	81.66410.0294	KARO0391
100.	81.61510.0761	KARO0862	130.	81.66410.0308	KARO0386
101.	81.61510.0762	KARO0863	131.	81.66410.0309	KARO0387
102.	81.61510.0801	KARO0759	132.	81.66410.0352	KARO0325
103.	81.61510.0802	KARO0758	133.	81.66410.0353	KARO0328
104.	81.61510.5161	KARO0342	134.	81.66410.6086	KARO0389
105.	81.61510.5162	KARO0341	135.	81.66410.6086	KARO0437
106.	81.61510.5163	KARO0332	136.	81.66410.6086	KARO0438
107.	81.61510.5164	KARO0331	137.	81.66410.6599	KARO0740
108.	81.61510.5181	KARO0343	138.	81.66410.6606	KARO0410
109.	81.61510.5187	KARO0379	139.	81.66410.6606	KARO0760
110.	81.61510.5187	KARO0850	140.	81.66410.6625	KARO0741
111.	81.61510.5196	KARO0335	141.	81.66440.192	KARO0411
112.	81.61510.5197	KARO0336	142.	81.66440.0192	KARO0757
113.	81.62410.0046	KARO0362	143.	81.66912.0033	KARO0324
114.	81.62410.0047	KARO0364	144.	81.66912.0034	KARO0323
115.	81.62410.0048	KARO0363	145.	85.41610.4012	KARO0416
116.	81.62410.0049	KARO0365	146.	85.61110.0035	KARO0414
117.	81.62410.0063	KARO0349	147.	85.61110.0036	KARO0413
118.	81.62410.0064	KARO0346	148.	85.61110.0040	KARO0415
119.	81.62410.2224	KARO0347	149.	85.61851.6003	KARO0403
120.	81.62410.2225	KARO0348			

LISTA UPOREDNIH OE I RAPIDEX BROJEVA - MERCEDES

1.	901 630 69 07	KARO0528	31.	941 880 02 25	KARO0460
2.	901 630 70 07	KARO0527	32.	941 880 03 25	KARO0461
3.	901 750 02 02	KARO0526	33.	941 880 03 44	KARO0508
4.	901 880 01 03	KARO0525	34.	941 880 04 44	KARO0507
5.	901 880 08 70	KARO0529	35.	941 880 09 70	KARO0456
6.	906 637 77 19	KARO0531	36.	941 880 10 70	KARO0455
7.	906 637 78 19	KARO0530	37.	941 880 23 70	KARO0454
8.	906 880 01 70	KARO0532	38.	941 880 24 70	KARO0453
9.	906 880 05 70	KARO0533	39.	941 880 27 70	KARO0457
10.	930 520 00 07	KARO0448	40.	941 880 28 70	KARO0458
11.	940 666 24 01	KARO0556	41.	941 884 02 22	KARO0477
12.	940 666 25 01	KARO0555	42.	941 884 03 22	KARO0476
13.	940 885 01 25	KARO0559	43.	941 884 04 22	KARO0471
14.	940 885 02 25	KARO0560	44.	941 884 05 22	KARO0470
15.	940 890 05 25	KARO0550	45.	941 884 06 22	KARO0510
16.	940 890 05 76	KARO0551	46.	941 884 07 22	KARO0509
17.	940 890 06 25	KARO0549	47.	941 884 11 22	KARO0473
18.	940 890 06 76	KARO0552	48.	941 884 12 22	KARO0472
19.	941 522 00 04	KARO0436	49.	941 884 14 22	KARO0475
20.	941 522 01 67	KARO0486	50.	941 884 15 22	KARO0474
21.	941 660 00 01	KARO0479	51.	941 885 08 25	KARO0464
22.	941 660 01 01	KARO0478	52.	941 885 09 22	KARO0561
23.	941 660 04 01	KARO0481	53.	941 885 09 22	KARO0462
24.	941 660 05 01	KARO0480	54.	941 885 09 25	KARO0463
25.	941 666 19 01	KARO0483	55.	941 885 13 01	KARO0459
26.	941 666 20 01	KARO0482	56.	941 885 14 01	KARO0452
27.	941 666 21 01	KARO0485	57.	941 885 34 22	KARO0467
28.	941 666 22 01	KARO0484	58.	941 885 35 22	KARO0466
29.	941 750 00 09	KARO0468	59.	941 885 38 22	KARO0465
30.	941 751 12 18	KARO0469	60.	943 660 06 01	KARO0520

LISTA UPOREDNIH OE I RAPIDEX BROJEVA - MERCEDES

61.	943 660 07 01	KARO0519	91.	944 522 01 67	KARO0487
62.	943 660 10 01	KARO0518	92.	944 666 13 01	KARO0554
63.	943 660 11 01	KARO0517	93.	944 666 14 01	KARO0553
64.	943 666 08 37	KARO0522	94.	944 880 02 70	KARO0558
65.	943 666 09 37	KARO0521	95.	944 880 03 70	KARO0557
66.	943 750 02 18	KARO0506	96.	944 885 07 25	KARO0563
67.	943 750 05 18	KARO0505	97.	944 885 08 25	KARO0562
68.	943 880 02 70	KARO0492	98.	973 666 25 01	KARO0541
69.	943 880 03 70	KARO0491	99.	973 666 26 01	KARO0542
70.	943 880 06 70	KARO0494	100.	973 880 04 70	KARO0544
71.	943 880 07 70	KARO0493	101.	973 880 05 70	KARO0545
72.	943 880 74 70	KARO0498	102.	973 880 10 70	KARO0543
73.	943 880 75 70	KARO0499	103.	973 880 11 70	KARO0546
74.	943 884 00 23	KARO0516	104.	973 880 16 70	KARO0547
75.	943 884 01 23	KARO0515	105.	973 880 17 70	KARO0548
76.	943 884 02 23	KARO0514	106.	973 881 11 01	KARO0537
77.	943 884 03 23	KARO0513	107.	973 881 12 01	KARO0538
78.	943 884 06 23	KARO0512	108.	973 881 46 01	KARO0539
79.	943 884 07 23	KARO0511	109.	973 881 47 01	KARO0540
80.	943 885 00 74	KARO0500	110.	973 881 67 01	KARO0536
81.	943 885 01 74	KARO0501	111.	973 881 68 01	KARO0535
82.	943 885 02 01	KARO0495	112.	973 884 01 85	KARO0534
83.	943 885 03 01	KARO0497			
84.	943 885 03 25	KARO0490			
85.	943 885 03 74	KARO0502			
86.	943 885 04 22	KARO0504			
87.	943 885 04 25	KARO0489			
88.	943 885 04 26	KARO0496			
89.	943 885 05 22	KARO0503			
90.	943 885 05 25	KARO0488			

PREDI NA DELOVI KABINE - RENAULT

LISTA UPOREDNIH OE I RAPIDEX BROJEVA - RENAULT

1.	1079997	KARO0783	22.	5010578247	KARO0768
2.	3171391	KARO0782	23.	5010578248	KARO0772
3.	20583434	KARO0786	24.	5010578335	KARO0003
4.	20721840	KARO0785	25.	5010578336	KARO0002
5.	5001867497	KARO0773	26.	5010578348	KARO0763
6.	5010353170	KARO0770	27.	5010578350	KARO0761
7.	5010353495	KARO0788	28.	5010578381	KARO0004
8.	5010353496	KARO0787	29.	5010578387	KARO0418
9.	5010445634	KARO0774	30.	5010578395	KARO0778
10.	5010468635	KARO0007	31.	5010578396	KARO0777
11.	5010468637	KARO0775	32.	5010578397	KARO0780
12.	5010468879	KARO0771	33.	5010578398	KARO0779
13.	5010544027	KARO0765	34.	5010578401	KARO0776
14.	5010544030	KARO0764	35.	5010578401	KARO0008
15.	5010544308	KARO0790	36.	5010578498	KARO0762
16.	5010544309	KARO0789	37.	5010578534	KARO0769
17.	5010544561	KARO0793	38.	5010578754	KARO0009
18.	5010574309	KARO0791	39.	5010623600	KARO0001
19.	5010574311	KARO0792	40.	7420498623	KARO0784
20.	5010578237	KARO0767	41.	7420518311	KARO0781
21.	5010578238	KARO0766			

LISTA UPOREDNIH OE I RAPIDEX BROJEVA - SCANIA

1.	1 324 597	KARO0229	8.	1 357 599	KARO0264
2.	1 324 598	KARO0227	9.	1 357 600	KARO0263
3.	1 324 605	KARO0246	10.	1 357 602	KARO0258
4.	1 335 676	KARO0808	11.	1 364 665	KARO0245
5.	1 335 677	KARO0807	12.	1 364 666	KARO0244
6.	1 354 593	KARO0252	13.	1 366 384	KARO0226
7.	1 354 594	KARO0251	14.	1 366 832	KARO0239

PREDI NA DELOVI KABINE - SCANIA

LISTA UPOREDNIH OE I RAPIDEX BROJEVA - SCANIA

15.	1 370 107	KARO0801	45.	1 422 843	KARO0286
16.	1 370 108	KARO0796	46.	1 426 109	KARO0820
17.	1 370 329	KARO0234	47.	1 426 110	KARO0819
18.	1 370 330	KARO0303	48.	1 431 920	KARO0281
19.	1 371 754	KARO0803	49.	1 431 921	KARO0280
20.	1 371 757	KARO0241	50.	1 431 922	KARO0279
21.	1 371 758	KARO0242	51.	1 431 923	KARO0278
22.	1 381 479	KARO0225	52.	1 431 925	KARO0288
23.	1 381 480	KARO0224	53.	1 431 926	KARO0287
24.	1 381 563	KARO0243	54.	1 431 931	KARO0285
25.	1 381 565	KARO0235	55.	1 431 932	KARO0284
26.	1 381 566	KARO0232	56.	1 431 933	KARO0818
27.	1 382 727	KARO0236	57.	1 431 934	KARO0817
28.	1 382 728	KARO0231	58.	1 438 563	KARO0832
29.	1 383 609	KARO0237	59.	1 438 564	KARO0831
30.	1 383 858	KARO0260	60.	1 439 788	KARO0816
31.	1 386 957	KARO0799	61.	1 439 789	KARO0815
32.	1 386 959	KARO0800	62.	1 442 653	KARO0290
33.	1 386 960	KARO0797	63.	1 442 654	KARO0289
34.	1 387 542	KARO0809	64.	1 451 246	KARO0268
35.	1 387 547	KARO0806	65.	1 459 133	KARO0269
36.	1 390 074	KARO0247	66.	1 459 134	KARO0270
37.	1 390 075	KARO0248	67.	1 459 135	KARO0271
38.	1 395 276	KARO0259	68.	1 459 141	KARO0275
39.	1 397 570	KARO0238	69.	1 459 142	KARO0276
40.	1 397 571	KARO0804	70.	1 459 145	KARO0272
41.	1 400 213	KARO0228	71.	1 459 146	KARO0838
42.	1 401 929	KARO0240	72.	1 466 031	KARO0266
43.	1 401 931	KARO0802	73.	1 466 032	KARO0265
44.	1 408 465	KARO0261	74.	1 466 034	KARO0835

LISTA UPOREDNIH OE I RAPIDEX BROJEVA - SCANIA

75.	1 466 035	KARO0834	105.	1 543 609	KARO0827
76.	1 485 486	KARO0262	106.	1 543 634	KARO0223
77.	1 495 577	KARO0814	107.	1 543 635	KARO0222
78.	1 495 578	KARO0813	108.	1 544 330	KARO0256
79.	1 496 659	KARO0257	109.	1 544 331	KARO0255
80.	1 498 179	KARO0292	110.	1 726 851	KARO0233
81.	1 498 180	KARO0293	111.	1 727 991	KARO0812
82.	1 501 342	KARO0296	112.	1 727 992	KARO0811
83.	1 501 343	KARO0297	113.	1 743 177	KARO0837
84.	1 504 131	KARO0302	114.	1 748 085	KARO0274
85.	1 512 423	KARO0295	115.	1 748 086	KARO0273
86.	1 512 424	KARO0294	116.	1 779 118	KARO0824
87.	1 515 190	KARO0805	117.	1 779 119	KARO0823
88.	1 515 194	KARO0249	118.	1 785 531	KARO0810
89.	1 515 195	KARO0250	119.	1 856 472	KARO0829
90.	1 517 649	KARO0795	120.	1 856 473	KARO0830
91.	1 517 650	KARO0794	121.	1 856 474	KARO0825
92.	1 535 039	KARO0821	122.	1 856 475	KARO0826
93.	1 535 040	KARO0822	123.	1 858 803	KARO0833
94.	1 535 045	KARO0253	124.	20379175	KARO0842
95.	1 535 048	KARO0299	125.	20379176	KARO0841
96.	1 535 049	KARO0254	126.	20453684	KARO0844
97.	1 535 052	KARO0298	127.	20453960	KARO0840
98.	1 536 807	KARO0277	128.	20467038	KARO0845
99.	1 537 675	KARO0798	129.	20529765	KARO0846
100.	1 538 383	KARO0267	130.	3 987 253	KARO0843
101.	1 538 384	KARO0283	131.	8 189 329	KARO0839
102.	1 538 385	KARO0282			
103.	1 543 607	KARO0836			
104.	1 543 608	KARO0828			

LISTA UPOREDNIH OE I RAPIDEX BROJEVA - VOLVO

1.	1063509	KARO0145
2.	1063726	KARO0218
3.	1079981	KARO0211
4.	1079981	KARO0444
5.	1626679	KARO0147
6.	1626680	KARO0146
7.	3090484	KARO0203
8.	3171391	KARO0581
9.	3175246	KARO0155
10.	3175247	KARO0154
11.	3175376	KARO0221
12.	3175406	KARO0208
13.	3175407	KARO0207
14.	3175545	KARO0168
15.	3175546	KARO0167
16.	3175547	KARO0170
17.	3175548	KARO0169
18.	3175927	KARO0194
19.	3175928	KARO0195
20.	3175929	KARO0199
21.	3175930	KARO0200
22.	3175937	KARO0197
23.	3175938	KARO0198
24.	3980869	KARO0142
25.	3980870	KARO0141
26.	3987252	KARO0445
27.	3987252	KARO0212
28.	8141003	KARO0161
29.	8141004	KARO0160
30.	8141236	KARO0153

PREDI NA DELOVI KABINE - VOLVO

LISTA UPOREDNIH OE I RAPIDEX BROJEVA - VOLVO

31.	8141237	KARO0152
32.	8141289	KARO0144
33.	8141290	KARO0143
34.	8155808	KARO0163
35.	8189092	KARO0151
36.	8189093	KARO0150
37.	8191220	KARO0148
38.	20360266	KARO0183
39.	20360507	KARO0149
40.	20360788	KARO0205
41.	20360789	KARO0206
42.	20379171	KARO0220
43.	20379172	KARO0219
44.	20379437	KARO0159
45.	20379438	KARO0158
46.	20379439	KARO0157
47.	20392599	KARO0213
48.	20392599	KARO0215
49.	20398466	KARO0202
50.	20398467	KARO0201
51.	20398707	KARO0442
52.	20398707	KARO0180
53.	20398708	KARO0441
54.	20398708	KARO0179
55.	20398709	KARO0440
56.	20398709	KARO0178
57.	20398907	KARO0165
58.	20398908	KARO0164
59.	20409818	KARO0171
60.	20425418	KARO0185

PREDI NA DELOVI KABINE - VOLVO

LISTA UPOREDNIH OE I RAPIDEX BROJEVA - VOLVO

61.	20425419	KARO0184
62.	20425626	KARO0175
63.	20425627	KARO0173
64.	20429680	KARO0174
65.	20452847	KARO0189
66.	20452848	KARO0188
67.	20452886	KARO0187
68.	20452887	KARO0186
69.	20453627	KARO0191
70.	20453628	KARO0190
71.	20453676	KARO0177
72.	20453677	KARO0176
73.	20453716	KARO0166
74.	20453900	KARO0209
75.	20453930	KARO0192
76.	20453931	KARO0193
77.	20456963	KARO0172
78.	20467037	KARO0196
79.	20529478	KARO0217
80.	20529483	KARO0216
81.	20529765	KARO0204
82.	20529765	KARO0156
83.	20721840	KARO0214
84.	205529672	KARO0181
85.	205529688	KARO0182

DAF 65CF, 75CF, 85CF, 95XF (2000 - 2006)

OE broj	MEKRA broj	Opis	Položaj	Grejač	Dimenzije (mm)	RAPIDEX broj
1425104	61.3730.324H		◀ ▶		384 x 205 x 120	KABI0387
1425105	61.3730.326H		◀ ▶		384 x 205 x 120	KABI0381
1425109	15.3731.470H				368 x 189 x 40	KABI0469
1425113	11.3730.210H					KABI0470

DAF 65CF, 75CF, 85CF, 95XF (2000 - 2006)

OE broj	MEKRA broj	Opis	Položaj	Grejač	Dimenzije (mm)	RAPIDEX broj
1425108	61.3860.214H		◀ ▶		219 x 170 x 120	KABI0471
1425111	15.3861.114H				203 x 154 x 36	KABI0472
1425114	11.3860.500H					KABI0473

DAF 65CF, 75CF, 85CF, 95XF (2000 - 2006)

OE broj	MEKRA broj	Opis	Položaj	Grejač	Dimenzije (mm)	RAPIDEX broj
1670877	61.9065.114H		◀ ▶		209 x 218 x 136	KABI0474
1670878	15.9060.870H				204 x 195 x 58	KABI0475
1670888	11.9060.100H					KABI0476

DAF XF105, CF (2006 - ...)

OE broj	MEKRA broj	Opis	Položaj	Grejač	Dimenzije (mm)	RAPIDEX broj
1692557	61.5700.210H		◀ ▶		411 x 228 x 140	KABI0477
1689348	61.5700.110H		◀ ▶		411 x 228 x 140	KABI0478
1685330	15.5701.840H				363 x 177 x 15	KABI0479
1644325	11.5700.100H					KABI0480

DAF XF105, CF (2006 - ...)

OE broj	MEKRA broj	Opis	Položaj	Grejač	Dimenzije (mm)	RAPIDEX broj
1692556	61.5710.210H		◀ ▶		239 x 221 x 140	KABI0481
1689347	61.5710.110H		◀ ▶		239 x 221 x 140	KABI0482
1685331	15.5711.870H				207 x 161 x 15	KABI0483
1644326	11.5710.110H					KABI0484

DAF XF105, CF (2006 - ...)

OE broj	MEKRA broj	Opis	Položaj	Grejač	Dimenzije (mm)	RAPIDEX broj
1685324	58.5701.100H		◀		818 x ... x 40	KABI0485
1685325	58.5701.200H		▶		818 x ... x 40	KABI0486
1644324	20.5700.410H					KABI0487

DAF XF105, CF (2006 - ...)

OE broj	MEKRA broj	Opis	Položaj	Grejač	Dimenzije (mm)	RAPIDEX broj
1669573	59.5520.230H		◀ ▶		319 x 187 x 50	KABI0488

**IVECO EUROTECH, EUROSTAR, EUROTRAKKER (1993 - 2006),
EUROCARGO (2000 - 2006), STRALIS (2002 - 2006)**

OE broj	MEKRA broj	Opis	Položaj	Grejač	Dimenzije (mm)	RAPIDEX broj
98472977	51.4601.120H		◀ ▶		355 x 215 x 140	KABI0245
98409216	51.4601.235H		◀ ▶		355 x 215 x 140	KABI0233
93190970	15.4601.164H				340 x 200 x 14	KABI0489
93190971	20.4601.100H					KABI0490

IVECO EUROTECH, EUROSTAR, EUROTRAKKER (1993 - 2006), EUROCARGO (2000 - 2006), STRALIS (2002 - 2006)



OE broj	MEKRA broj	Opis	Položaj	Grejač	Dimenzije (mm)	RAPIDEX broj
98472982	51.4612.120H		◀ ▶		457 x 215 x 140	KABI0232
98473011	51.4612.235H		◀ ▶		457 x 215 x 140	KABI0235
93190976	15.4611.164H				440 x 200 x 14	KABI0491
93190977	20.4611.100H					KABI0492

IVECO EUROTECH, EUROSTAR, EUROTRAKKER (1993 - 2006), EUROCARGO (2000 - 2006), STRALIS (2002 - 2006)



OE broj	MEKRA broj	Opis	Položaj	Grejač	Dimenzije (mm)	RAPIDEX broj
98473013	56.4622.200H		◀ ▶		189 x 215 x 140	KABI0229
98473014	56.4622.300H		◀ ▶		189 x 215 x 140	KABI0230
93190973	15.4622.164H				200 x 175 x 14	KABI0494
93190974	20.4621.100H					KABI0495

IVECO EUROTECH, EUROSTAR, EUROTRAKKER (1993 - 2006), EUROCARGO (2000 - 2006), STRALIS (2002 - 2006)



OE broj	MEKRA broj	Opis	Položaj	Grejač	Dimenzije (mm)	RAPIDEX broj
98472974	59.4631.220H		◀ ▶		284 x 185 x 80	KABI0496
98472975	59.4631.320H		◀ ▶		284 x 185 x 80	KABI0497
93190984	15.4632.164H				260 x 160 x 10	KABI0498

IVECO EUROCARGO, STRALIS



OE broj	MEKRA broj	Opis	Položaj	Grejač	Dimenzije (mm)	RAPIDEX broj
504150524			◀			KABI0499
504150525			▶			KABI0500
504150526			◀			KABI0501
504150527			▶			KABI0502

MAN M90, F90



OE broj	MEKRA broj	Opis	Položaj	Grejač	Dimenzije (mm)	RAPIDEX broj
81.63730.6221	51.3410.147H		◀ ▶		377 x 189 x 65	KABI0409
81.63730.6233	51.3410.127H		◀ ▶		377 x 189 x 65	KABI0503
81.63733.0064	40.3640.422H				364 x 175 x 3	KABI0504

MAN M90, F90



OE broj	MEKRA broj	Opis	Položaj	Grejač	Dimenzije (mm)	RAPIDEX broj
81.63730.6235	56.2660.127H		◀ ▶		215 x 165 x 55	KABI0505
81.63730.6236	56.2660.147H		◀ ▶		215 x 165 x 55	KABI0506
81.63733.0061	40.2665.204H				200 x 150 x 3	KABI0507
81.63733.6007	40.2660.404H				200 x 150 x 3	KABI0508

MAN L2000, M2000, F2000



OE broj	MEKRA broj	Opis	Položaj	Grejač	Dimenzije (mm)	RAPIDEX broj
81.63730.6315	51.3735.124H		◀		384 x 205 x 120	KABI0319
81.63730.6304	51.3736.124H		▶		384 x 205 x 120	KABI0359
81.63730.6316	51.3735.126H		◀		384 x 205 x 120	KABI0380
81.63730.6305	51.3736.126H		▶		384 x 205 x 120	KABI0509
81.63733.0067	15.3731.074H				368 x 189 x 40	KABI0401
	11.3730.310H				367 x 187 x 60	KABI0382
81.63732.0044					374 x 196 x 40	KABI0400

MAN L2000, M2000, F2000



OE broj	MEKRA broj	Opis	Položaj	Grejač	Dimenzije (mm)	RAPIDEX broj
81.63730.6294	59.3652.127H		◀ ▶		324 x 184 x 70	KABI0510
81.63733.0048	40.3655.204				311 x 171 x 3	KABI0511

MAN L2000, M2000, F2000



OE broj	MEKRA broj	Opis	Položaj	Grejač	Dimenzije (mm)	RAPIDEX broj
81.63730.6306	56.3860.112H		◀ ▶		219 x 170 x 120	KABI0322
81.63730.6307	56.3860.114H		◀ ▶		219 x 170 x 120	KABI0512
81.63730.6317	56.3861.116H		◀		219 x 170 x 120	KABI0513
81.63730.6308	56.3862.116H		▶		219 x 170 x 120	KABI0328
81.63733.0069	15.3812.410H				203 x 154 x 36	KABI0514
81.63732.0045	11.3860.300H				219 x 159 x 40	KABI0289

MAN TGA, TGL, TGM



OE broj	MEKRA broj	Opis	Položaj	Grejač	Dimenzije (mm)	RAPIDEX broj
81.63730.6395	51.3921.222H		◀		399 x 207 x 137	KABI0386
81.63730.6399	51.3922.222H		▶		399 x 207 x 137	KABI0384
81.63733.0082	15.3921.870H				379 x 176 x 47	KABI0385
81.63732.0055	11.3921.120H				399 x 210 x 52	KABI0290
81.63732.0054	11.3921.110H				399 x 196 x 52	KABI0327

MAN TGA, TGL, TGM



OE broj	MEKRA broj	Opis	Položaj	Grejač	Dimenzije (mm)	RAPIDEX broj
81.63730.6409	56.3931.222H		◀		188 x 207 x 129	KABI0224
81.63730.6410	56.3932.222H		▶		188 x 220 x 130	KABI0515
81.63733.0085	15.3931.870H				177 x 167 x 38	KABI0383
81.63732.0057	11.3931.110H		◀		187 x 197 x 52	KABI0516
81.63732.0056	11.3931.120H		▶		187 x 197 x 52	KABI0517

MAN TGA, TGL, TGM



OE broj	MEKRA broj	Opis	Položaj	Grejač	Dimenzije (mm)	RAPIDEX broj
81.63730.6352	59.3941.212H		◀ ▶		324 x 185 x 80	KABI0518
81.63733.6041	15.3941.670H				324 x 185 x 15	KABI0519

MAN TGA, TGL, TGM (2006 - ...)



OE broj	MEKRA broj	Opis	Položaj	Grejač	Dimenzije (mm)	RAPIDEX broj
85.63730.6033	51.5720.140H		◀ ▶		426 x 200 x 135	KABI0520
81.63733.0103	40.5725.412H				412 x 188 x 3	KABI0521

MAN TGA, TGL, TGM (2006 - ...)



OE broj	MEKRA broj	Opis	Položaj	Grejač	Dimenzije (mm)	RAPIDEX broj
85.63730.6039	56.5730.140H		◀ ▶		202 x 198 x 126	KABI0522
81.63733.0106	40.5735.403H				190 x 184	KABI0523

MERCEDES 1013 - 2644, O303, 404, 405, 407



OE broj	MEKRA broj	Opis	Položaj	Grejač	Dimenzije (mm)	RAPIDEX broj
381 810 25 16	51.2530.120H		◀ ▶		370 x 182 x 64	KABI0524
381 810 73 16	51.2530.140H		◀ ▶		370 x 182 x 64	KABI0525
000 811 33 33	40.2530.222H				356 x 170 x 3	KABI0526
	40.2530.422H				356 x 170 x 3	KABI0527

MERCEDES SK, NG (1991 - 1996)



OE broj	MEKRA broj	Opis	Položaj	Grejač	Dimenzije (mm)	RAPIDEX broj
641 810 42 16	51.3680.147H				440 x 182 x 132	KABI0528
	40.3680.422H				427 x 169 x 3	KABI0529

MERCEDES SK, NG (1991 - 1996)



OE broj	MEKRA broj	Opis	Položaj	Grejač	Dimenzije (mm)	RAPIDEX broj
641 810 46 16	56.3670.147H				225 x 185 x 129	KABI0395
	40.3670.404H				209 x 169 x 3	KABI0530

MERCEDES ACTROS (1996 - ...), ECONIC (1998 - ...)



OE broj	MEKRA broj	Opis	Položaj	Grejač	Dimenzije (mm)	RAPIDEX broj
	61.3780.147H				433 x 188 x 85	KABI0240
000 810 91 16	61.3783.167H				433 x 188 x 85	KABI0416
001 811 20 33	15.3784.470H				433 x 188 x 15	KABI0417
000 810 95 16	61.3782.147H				433 x 188 x 68	KABI0418
000 810 94 16	61.3782.167H				433 x 188 x 68	KABI0293

MERCEDES ACTROS (1996 - ...), ATEGO (1998 - 2004), ECONIC (1998 - ...)



OE broj	MEKRA broj	Opis	Položaj	Grejač	Dimenzije (mm)	RAPIDEX broj
	61.3770.147H				200 x 200	KABI0360
001 811 21 33	15.3774.410H				200 x 200 x 15	KABI0461
001 811 60 33	15.3771.174H				200 x 200 x 15	KABI0407
000 810 96 16	61.3772.147H				200 x 200 x 68	KABI0237

MERCEDES ACTROS (1996 - ...), ECONIC (1998)



OE broj	MEKRA broj	Opis	Položaj	Grejač	Dimenzije (mm)	RAPIDEX broj
941 810 10 16	59.3792.127H				310 x 170 x 83	KABI0405
001 811 22 33	15.3794.410H				310 x 170 x 15	KABI0404

MERCEDES ATEGO (1998 - 2004), AXOR (2001 - 2004)



OE broj	MEKRA broj	Opis	Položaj	Grejač	Dimenzije (mm)	RAPIDEX broj
000 810 02 79	61.3752.147H				380 x 170 x 68	KABI0388
001 811 34 33	15.3752.470H				380 x 170 x 15	KABI0415

MERCEDES ATEGO II, AXOR II (2004 - ...)



OE broj	MEKRA broj	Opis	Položaj	Grejač	Dimenzije (mm)	RAPIDEX broj
000 810 18 79	61.5751.167				435 x 215 x 129	KABI0375
000 810 15 79	61.5752.167				435 x 215 x 129	KABI0140
001 811 99 33	15.5750.840H				431 x 186 x 15	KABI0374



MERCEDES ATEGO II, AXOR II (2004)



OE broj	MEKRA broj	Opis	Položaj	Grejač	Dimenzije (mm)	RAPIDEX broj
000 810 16 79	61.5770.147H		◀▶		215 x 199 x 129	KABI0379
002 811 00 33	15.5770.870H				192 x 186 x 15	KABI0531

MERCEDES ACTROS (1996 - ...), ECONIC (1998 - ...)



RAPIDEX broj
KABI0292



RAPIDEX broj
KABI0308

RENAULT MIDLUM, PREMIUM, KERAX (2006 - ...)



OE broj	MEKRA broj	Opis	Položaj	Grejač	Dimenzije (mm)	RAPIDEX broj
5010623225	59.3900.142H		◀		880 x 340 x 155	KABI0532
5010623226	59.3900.242H		▶		880 x 340 x 155	KABI0533
7420862795	15.3900.840H		◀▶		337 x 202	KABI0534
7420862810	15.3911.871H		◀		197 x 200	KABI0535
7420862815	15.3911.872H		▶		197 x 200	KABI0536

RENAULT PREMIUM ROUTE (2005 - ...)



OE broj	MEKRA broj	Opis	Položaj	Grejač	Dimenzije (mm)	RAPIDEX broj
5010578505	53.3901.123H		◀		880 x 340 x 155	KABI0537
5010578506	53.3901.223H		▶		880 x 340 x 155	KABI0538
7420862795	15.3900.840H		◀▶		337 x 202	KABI0534
7420903745	15.3910.871H		◀		203 x 189	KABI0539
7420903746	15.3910.872H		▶		203 x 189	KABI0540

RENAULT MAGNUM (1992)



OE broj	MEKRA broj	Opis	Položaj	Grejač	Dimenzije (mm)	RAPIDEX broj
5001838475	51.2860.112H		◀		480 x 240 x 90	KABI0541
5001842202	51.2860.212H		▶		480 x 240 x 90	KABI0542
5000289377	15.2860.880H		◀▶		460 x 187 x 30	KABI0543

RENAULT MAGNUM (1992)



OE broj	MEKRA broj	Opis	Položaj	Grejač	Dimenzije (mm)	RAPIDEX broj
5000296871	56.2870.120H		▶		220 x 230 x 90	KABI0545
5000289373	40.2875.404H		▶		200 x 151 x 3	KABI0544

SCANIA SERIJA 3 (1981 - 1996)



OE broj	MEKRA broj	Opis	Položaj	Grejač	Dimenzije (mm)	RAPIDEX broj
316920	56.1561.110H		◀▶		258 x 152 x 30	KABI0356
316918	40.1561.105H				253 x 150 x 3	KABI0354

SCANIA SERIJA 4, R, P, T (1996 - ...)



OE broj	MEKRA broj	Opis	Položaj	Grejač	Dimenzije (mm)	RAPIDEX broj
1 723 518	59.4002.300H		◀		530 x 340 x 120	KABI0321
1 723 519	59.4002.400H		▶		530 x 340 x 120	KABI0546
1 346 378	15.4002.110H				432 x 200 x 18	KABI0358

SCANIA SERIJA 4, R, P, T (1996 - ...)



OE broj	MEKRA broj	Opis	Položaj	Grejač	Dimenzije (mm)	RAPIDEX broj
1 765 809	56.4000.140H		◀		250 x 190 x 130	KABI0547
1 765 810	56.4001.140H		▶		250 x 190 x 130	KABI0548
1 767 265	15.4001.740H		◀▶		184 x 160 x 20	KABI0549

SCANIA SERIJA 4 R, P, T (2004 - ...)



OE broj	MEKRA broj	Opis	Položaj	Grejač	Dimenzije (mm)	RAPIDEX broj
1 504 678	59.5520.040H		◀▶		319 x 187 x 75	KABI0550

VOLVO FH, FM, NH (1993 - ...)



OE broj	MEKRA broj	Opis	Položaj	Grejač	Dimenzije (mm)	RAPIDEX broj
3980924	59.3702.231H		◀		469 x 440 x 117	KABI0141
3980935	59.3712.441H		▶		665 x 443 x 117	KABI0242
3090737	15.3702.470H				433 x 198 x 16	KABI0357
3090739	15.3712.410H		▶		181 x 175 x 24	KABI0241

VOLVO FH II, FM II (2002 - ...)



OE broj	MEKRA broj	Opis	Položaj	Grejač	Dimenzije (mm)	RAPIDEX broj
20567637	59.2244.300H		◀		530 x 420 x 110	KABI0243
	59.2244.400H		▶		530 x 420 x 110	KABI0551
20455968	15.2240.865H				200 x 435	KABI0002

VOLVO FH II, FM II (2002 - ...)



OE broj	MEKRA broj	Opis	Položaj	Grejač	Dimenzije (mm)	RAPIDEX broj
1765807	56.2240.140H		◀		200 x 250 x 70	KABI0552
1765808	56.2241.140H		▶		200 x 250 x 70	KABI0553
21070768	15.2242.870H				180 x 200	KABI0244
	15.2241.870H				176 x 188	KABI0330







VOLVO FH II, FM II (2002 - ...)



OE broj	MEKRA broj	Opis	Položaj	Grejač	Dimenzije (mm)	RAPIDEX broj
1096643	59.3601.128H		▶		284 x 174 x 62	0554



LEGENDA:

	MANUELNO PODEŠAVANJE		STAKLO		GREJAČ	◀	LEVI POLOŽAJ
	ELEKTRIČNO PODEŠAVANJE		PLOKLOPAC KUČIŠTE	◀▶	UNIVERZALAN POLOŽAJ	▶	DESNI POLOŽAJ

CILINDRI ZA DIZANJE KABINE			
Poz.	Tip vozila	OE broj	RAPIDEX broj
1.	DAF F95	1295724	KABI0269
			
2.	MAN F2000	83.41723.6099	HIDR0075
			
3.	MAN	83.41723.6500	KABI0555
			
4.	MAN	83.41723.6029	KABI0556
			
5.	MAN F90, F2000	81.41723.6076	KABI0335
			
6.	MAN TGA 410-430	83.41723.6123	HIDR0074
			
7.	MAN TGA 460-480	83.41723.6124	HIDR0073
			



CILINDRI ZA DIZANJE KABINE			
Poz.	Tip vozila	OE broj	RAPIDEX broj
8.	MERCEDES SK	001 553 09 05	KABI0557
			
9.	MERCEDES SK	001 553 17 05	KABI0558
			
10.	MERCEDES SK	001 553 96 05	KABI0559
			
11.	MERCEDES SK	001 553 10 05	KABI0560
			
12.	MERCEDES ATEGO	973 553 00 05	KABI0265
			
13.	MERCEDES AXOR	002 553 44 05	KABI0561
			
14.	MERCEDES AXOR	002 553 82 05	KABI0263
			

CILINDRI ZA DIZANJE KABINE			
Poz.	Tip vozila	OE broj	RAPIDEX broj
15.	MERCEDES AXOR	002 553 85 05	KABI0264
			
16.	MERCEDES ACTROS	002 553 10 05	KABI0072
			
17.	MERCEDES ACTROS	002 553 91 05	KABI0334
			
18.	MERCEDES ACTROS	002 553 92 05	KABI0333
			
19.	MERCEDES ACTROS	002 553 54 05	KABI0331
			
20.	SCANIA SERIJA 4	1 549 738	KABI0268
			
21.	VOLVO FH12	20922303	HIDR0048
			

PUMPE ZA DIZANJE KABINE				
Poz.		Tip vozila	OE broj	RAPIDEX broj
1.		MAN F90, F2000	81.41723.6008	KABI0562
2.		MAN F90, F2000	83.41723.6114	KABI0563
3.		MAN TGA, TGM, TGX, TGS	85.41723.6020	HIDR0047
4.		MERCEDES SK, LK	000 553 79 01	HIDR0076
5.		MERCEDES SK, ACTROS	001 553 59 01	HIDR0077
6.		MERCEDES ACTROS	001 553 34 01	KABI0564

PUMPE ZA DIZANJE KABINE				
Poz.		Tip vozila	OE broj	RAPIDEX broj
7.		MERCEDES ACTROS	001 553 35 01	KABI0565
8.		MERCEDES ACTROS	001 553 36 01	HIDR0046
9.		MERCEDES ACTROS	001 553 37 01	HIDR0051
10.		MERCEDES ACTROS	001 553 38 01	KABI0566
11.		SCANIA SERIJA 4, P, R, T	1 234 778	KABI0567
12.		VOLVO		KABI0568

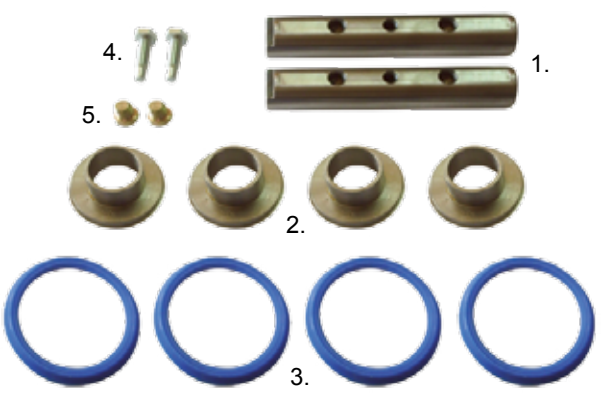
DAF			
Poz.	Slika	Tip vozila / OE broj	RAPIDEX broj
1.		DAF 95 1. 1290794 x 2 2. 1304576 x 2 3. 1290795 x 4 4. 0212045 x 2 5. 0661173 x 2	KABI0392
2.		DAF 95 1. 0077390 x 2 2. 1266426 x 4 3. 1271385 x 4 4. 0079330 x 2 5. 1269537 x 2 6. 0325081 x 2	KABI0569
3.		DAF 95 1. 1290794 x 2 2. 1332194 x 2 3. 1304576 x 2 4. 1656266 x 4 5. 1290795 x 4 6. 0661173 x 2 7. 1399159 x 4	KABI0570
4.		DAF XF 1. 1314545 x 2 2. 1332194 x 2 3. 1304569 x 2 4. 1266426 x 4 5. 1271385 x 4 6. 1269537 x 2 7. 0241496 x 2 8. 0661173 x 2	KABI0391

DAF			
Poz.	Slika	Tip vozila / OE broj	RAPIDEX broj
5.		DAF XF 1. 1314545 x 2 2. 1304569 x 2 3. 0661173 x 2	KABI0261
6.		DAF XF 1. 1332194 x 2 2. 1266426 x 4 3. 1271385 x 4 4. 1269537 x 2 5. 0241496 x 2	KABI0262
7.		DAF F65, 75, 85, CF65, 75, 85 1. 1396202 x 4 2. 0750928 x 2 3. 1304576 x 2 4. 1269537 x 2 5. 0079330 x 2 6. 0661173 x 2 7. 1248753 x 2 8. 1328885 x 2 9. 1656266 x 4 10. 1399159 x 4	KABI0571

DAF					
Poz.	Slika	Tip vozila	Dimenzije (mm)	OE broj	RAPIDEX broj
1.		DAF 65, F75, 85	85 x 20 x 23,8	1396202	KABI0572
2.		DAF 95	60 x 20 x 48	1290794	KABI0573
3.		DAF 95	90 x 20 x 70	1314545	KABI0574
4.		DAF 95	85 x 20 x 8	1290795	KABI0575
5.		DAF XF	62 x 48 x 5,7	1271385	KABI0576
6.		DAF XF	25 x 136,5	1332192	KABI0577
7.		DAF XF	51 x 30 x 25 x 20	1266426	KABI0578

MAN			
Poz.	Slika	Tip vozila / OE broj	RAPIDEX broj
1.		MAN F90, F2000 1. 81.96210.0407 x 2 2. 81.96210.0437 x 2 3. 81.96101.0638 x 2 4. 81.97112.0844 x 2 5. 06.36950.0510 x 2 6. 81.96503.0129 x 4	KABI0454
2.		MAN F90, F2000 1. 81.96210.0407 x 2 2. 81.96210.0437 x 4 3. 81.96101.0638 x 2 4. 81.97112.0844 x 2 5. 06.36950.0510 x 2 6. 81.96503.0129 x 4	KABI0453
3.		MAN F90, F2000 1. 81.96210.0400 x 4 2. 06.36950.0510 x 2	KABI0451
4.		MAN TGA 81.41715.6013 1. 85.96210.0019 x 2 2. 06.02813.5027 x 2 3. 06.02813.5024 x 2 4. 85.90710.0014 x 4 5. 06.29020.0127 x 2 6. 06.36950.0210 x 2 7. 85.96501.0002 x 4 8. 06.11251.2008 x 4 9. 85.41715.0006 x 4	KABI0394

MAN			
Poz.	Slika	Tip vozila / OE broj	RAPIDEX broj
5.		MAN TGA 81.41715.6014 1. 85.96210.0019 x 2 2. 06.02813.5027 x 2 3. 06.02813.5024 x 2 4. 85.90710.0014 x 4 5. 85.96210.0021 x 2 6. 06.11251.2008 x 4	KABI0393

MAN					
Poz.	Slika	Tip vozila	Dimenzije (mm)	OE broj	RAPIDEX broj
1.		MAN F90, F2000		81.61851.6023	KABI0390
2.		MAN TGA		85.61851.6003	KABI0366
3.		MAN F90, F2000, TGA	30 x 14 x 42	81.96210.0462	KABI0341
4.		MAN F90		81.96210.0089	KABI0579
5.		MAN F90		81.96210.0437	KABI0370
6.		MAN F90	50 x 16 x 29	81.96210.0400	KABI0580

MAN					
Poz.	Slika	Tip vozila	Dimenzije (mm)	OE broj	RAPIDEX broj
7.		MAN F90	60 x 15 x 18	81.96210.0407	KABI0372
8.		MAN F90		81.96210.0430	KABI0581
9.		MAN F90	Ø50 x 40 M10 x 25	81.96210.0101	VESA0592
10.		MAN F90	65 x 33 x 6	81.90712.0844	KABI0377
11.		MAN F90	70 x 32 x 4	81.96101.0638	KABI0376
12.		MAN F90, F2000		06.36950.0510	KABI0582
13.		MAN F2000		81.96503.0129	KABI0583
14.		MAN TGA	75 x 17 x 122	85.41715.0006	KABI0584
15.		MAN TGA		85.90710.0014	KABI0585

MAN					
Poz.	Slika	Tip vozila	Dimenzije (mm)	OE broj	RAPIDEX broj
16.		MAN TGA		81.41723.0067	KABI0586
17.		MAN TGA	65 x 49 x 11	85.96501.0002	KABI0587
18.		MAN F90		81.48227.0006	KOCN1368
19.		MAN F90, F2000		81.96420.0324	KABI0456
20.		MAN L2000, M2000		81.96420.0529	KABI0260
21.		MAN F90, F2000		81.32616.0007	KABI0350
22.		MAN L2000, M2000		81.32616.0008	KABI0259

MERCEDES			
Poz.	Slika	Tip vozila / OE broj	RAPIDEX broj
1.		MERCEDES NG, SK 387 310 00 77	KABI0452

MERCEDES					
Poz.	Slika	Tip vozila	Dimenzije (mm)	OE broj	RAPIDEX broj
1.		MERCEDES SK	M10 x 22	371 492 70 87	VESA0815
2.		MERCEDES SK, LK	20 x 8 x 100	385 268 14 74	KABI0588
3.		MERCEDES SK, LK	42 x 20	000 981 39 31	KABI0589
4.		MERCEDES ACTROS		942 500 00 50	KABI0440
5.		MERCEDES ACTROS		942 317 22 12	AMOR0223
6.		MERCEDES ACTROS MP2		942 317 18 12	KABI0338

MERCEDES					
Poz.	Slika	Tip vozila	Dimenzije (mm)	OE broj	RAPIDEX broj
7.		MERCEDES ACTROS MP2	65 x 16 x 64	942 317 23 12	KABI0337
8.		MERCEDES ACTROS, ACTROS MP2	69 x 16 x 64	000 992 16 03	KABI0080
9.		MERCEDES ATEGO II, AXOR, ACTROS		940 317 10 12	KABI0450
10.		MERCEDES ATEGO II, AXOR, ACTROS		940 317 11 12	KABI0449
11.		MERCEDES ATEGO II, AXOR, ACTROS		942 317 20 12	KABI0448
12.		MERCEDES ATEGO II, AXOR, ACTROS		942 317 21 12	KABI0447
13.		MERCEDES ACTROS		942 310 02 83	KABI0368
14.		MERCEDES ACTROS		942 310 03 83	KABI0367

SCANIA			
Poz.	Slika	Tip vozila / OE broj	RAPIDEX broj
1.		SERIJA 3, 4 1 742 999	KABI0270
2.		SERIJA 3, 4 1. 1 375 299 x 1 2. 1 324 713 x 1 3. 1 358 632 x 1 4. 1 324 712 x 1 5. 1 386 058 x 1 6. 804831 x 2	KABI0590
3.		SERIJA 3, 4 1. 1 343 135 x 2 2. 1 481 245 x 4	KABI0267
4.		SERIJA 3, 4 1. 1 377 562 x 1 2. 1 385 170 x 2	KABI0266

SCANIA					
Poz.	Slika	Tip vozila	Dimenzije (mm)	OE broj	RAPIDEX broj
1.		SERIJA 3, 4	20 x 16 x 40	550285	KABI0591
2.		SERIJA 3, 4	60 x 16 x 80	1 394 544	KABI0592
3.		SERIJA 3, 4	60 x 16 x 80	1 377 562	KABI0593
4.		SERIJA 3, 4	50 x 16,5 x 80	1 105 972	KABI0594
5.		SERIJA 3, 4		329 583	KABI0595
6.		SERIJA 3, 4	71 x 24 x 79,5	1 372 432	KABI0596
7.		SERIJA 3, 4		0 390 359	KABI0597
8.		SERIJA 3, 4		0 389 035	KABI0598
9.		SERIJA 3, 4	75 x 8	1 385 170	KABI0599

SCANIA					
Poz.	Slika	Tip vozila	Dimenzije (mm)	OE broj	RAPIDEX broj
10.		SERIJA 3, 4	55 x 22 x 44	0 385 266	KABI0600
11.		SERIJA 3, 4	74 x 21 x 10	1 353 965	KABI0601
12.		SERIJA 3, 4	63 x 21 x 20	1 343 134	KABI0602
13.		SERIJA 3, 4	Ø60 x 41 M8 x 1,25	0 384 595	KABI0603
14.		SERIJA 3, 4	Ø55 x 45 M8 x 1,25	1 349 805	KABI0604
15.		SERIJA 3, 4	Ø40 x 32 M8 x 1,25	1 349 810	KABI0605
16.		SERIJA 3, 4	44 x 21 x 28	1 302 008	KABI0606
17.		SERIJA 3, 4	16 x 81	1 744 210	KABI0607
18.		SERIJA 3, 4	16 x 120	1 744 211	KABI0608

VOLVO			
Poz.	Slika	Tip vozila / OE broj	RAPIDEX broj
1.		FH12, FH16 1. 1075266 x 2 2. 1075699 x 2 3. 980547 x 2 4. 1075341 x 4 5. 8143461 x 4 6. 969318 x 2 7. 941912 x 2	KABI0609
2.		FH12, FH16 1. 1075399 x 2 2. 8142699 x 2 3. 8142168 x 2 4. 8140869 x 2 5. 1629674 x 2 6. 1629673 x 2 7. 1075400 x 10	KABI0610
3.		FH12, FH16, FM9, FM12 1. 20390840 x 1 2. 977173 x 1 3. 982613 x 1 4. 20466221 x 1 5. 955903 x 1 6. 981948 x 1	KABI0611
4.		FH12, FH16, FM9, FM12 1. 20390840 x 2 2. 977173 x 2 3. 982613 x 2 4. 20466221 x 2 5. 955903 x 2 6. 981948 x 2	KABI0612

VOLVO					
Poz.	Slika	Tip vozila	Dimenzije (mm)	OE broj	RAPIDEX broj
1.		FH12, FH16, FM9, FM12		20390840	KABI0613
2.		F10, F12, F16		1580214	KABI0614
3.		FL6, FL10	33 x 8,5 x 28	463909	KABI0615
4.		F12, F16, FH12		1135080	KABI0616
5.		B10	Ø50 x 42 M12 x 1,5	6850149	KABI0617
6.		FH12, FH16		8143461	KABI0618
7.		FH12, FH16		1629665	KABI0619



DAF				
Poz.	Tip vozila	Opis	OE broj	RAPIDEX broj
1.	F95, 95XF, XF95, XF105	MEHANIZAM BRISAČA 550	1288698	KABI0620
2.	F95, 95XF, XF95, XF105	MOTOR BRISAČA	1254891	ELEK0106
3.	F95, 95XF	POLUGA BRISAČA	1245443	KABI0626
4.	F95, 95XF	POLUGA BRISAČA	1245445	KABI0627
5.	F95, 95XF	POLUGA BRISAČA	1245444	KABI0628
6.	F95, 95XF, XF95, XF105	PUMPICA BRISAČA	1343064	KABI0632
7.	F95, 95XF, XF95, XF105	RUČICA BRISAČA	1238778	KABI0636
8.	F95, 95XF, XF95, XF105	RUČICA BRISAČA	1238779	KABI0637

IVECO				
Poz.	Tip vozila	Opis	OE broj	RAPIDEX broj
1.	EURO CARGO, STRALIS	MOTOR BRISAČA	99439637	ELEK0081
2.	TECTOR, STRALIS	PUMPICA BRISAČA	500304249	KABI0633

MAN				
Poz.	Tip vozila	Opis	OE broj	RAPIDEX broj
1.	M2000, F2000	MEHANIZAM BRISAČA	81.26411.6091	KABI0621
2.	F2000	MEHANIZAM BRISAČA	81.26411.6089	KABI0622
3.	M2000, F2000	METLICA BRISAČA 600 mm	81.26440.6034	KABI0421
4.	TGL, TGM, TGA, TGS, TGX	METLICA BRISAČA 700 mm	81.26440.0068	RASV0008
5.	F90, F2000	MOTOR BRISAČA	81.26401.6119	KABI0247
6.	TGL, TGM, TGA, TGS, TGX	MOTOR BRISAČA	81.26401.6141	KABI0286
7.	M90, F90, L2000, M2000, F2000	POLUGA BRISAČA	81.26411.0098	KABI0191
8.	M90, F90, L2000, M2000, F2000	POLUGA BRISAČA	81.26411.0097	KABI0281
9.	M90, F90, L2000, M2000, F2000	POLUGA BRISAČA	81.26411.0096	KABI0282
10.	F90, F2000	POLUGA BRISAČA	81.26411.0094	KABI0283
11.	F90, F2000	POLUGA BRISAČA	81.26411.0093	KABI0284
12.	F90, F2000	POLUGA BRISAČA	81.26411.0095	KABI0285
13.	F90, F2000	PUMPICA BRISAČA	81.26485.6027	OPRE0015
14.	TGL, TGM, TGA, TGS, TGX	PUMPICA BRISAČA	81.26485.6032	OPRE0016
15.	M90, F90, L2000, M2000, F2000	RUČICA BRISAČA	81.26430.0081	KABI0279
16.	F90, F2000	RUČICA BRISAČA	81.26430.0080	KABI0280
17.	TGL, TGM, TGA, TGS, TGX	RUČICA BRISAČA	81.26430.6046	KABI0639

MERCEDES				
Poz.	Tip vozila	Opis	OE broj	RAPIDEX broj
1.	ACTROS	MEHANIZAM BRISAČA	941 820 02 41	KABI0647
2.	ACTROS	MEHANIZAM BRISAČA	941 820 04 41	KABI0623
3.	ATEGO	METLICA BRISAČA 650 mm	001 820 11 45	KABI0426

MERCEDES				
Poz.	Tip vozila	Opis	OE broj	RAPIDEX broj
4.	ACTROS, SK	METLICA BRISAČA 700 mm	001 820 12 45	KABI0349
5.	ACTROS	MOTOR BRISAČA	005 820 21 42	KABI0460
6.	SK	MOTOR BRISAČA	004 820 67 42	ELEK0168
7.	ACTROS	RUČICA BRISAČA	941 820 07 44	KABI0076
8.	ACTROS	RUČICA BRISAČA	941 820 09 44	KABI0037
9.	AXOR	RUČICA BRISAČA	001 820 37 44	KABI0640
10.	ACTROS	PUMPICA BRISAČA	000 869 40 21	OPRE0017
11.	SK	PUMPICA BRISAČA	000 860 32 26	KABI0634

SCANIA				
Poz.	Tip vozila	Opis	OE broj	RAPIDEX broj
1.	SERIJA 4 CP, CR, CT	METLICA BRISAČA 700 mm	1 431 178	KABI0403
2.	SERIJA 4	MOTOR BRISAČA	1 318 506	KABI0648
3.	SERIJA 4	MOTOR BRISAČA	1 392 755	KABI0649
4.	SERIJA 3	MOTOR BRISAČA	1 323 405	ELEK0107
5.	CP, CR, CT	MOTOR BRISAČA	1 859 562	KABI0650
6.	CP, CR, CT	POLUGA BRISAČA	1 525 890	KABI0629
7.	CP, CR, CT	POLUGA BRISAČA	1 525 888	KABI0630
8.	CP, CR, CT	POLUGA BRISAČA	1 525 889	KABI0631
9.	CP, CR, CT	PUMPICA BRISAČA	1 548 504	KABI0635
10.	CP, CR, CT	RUČICA BRISAČA	1 543 076	KABI0641
11.	CP, CR, CT	RUČICA BRISAČA	1 543 077	KABI0642
12.	CP, CR, CT	RUČICA BRISAČA	1 733 180	KABI0643
13.	CP, CR, CT	RUČICA BRISAČA	1 733 181	KABI0644

VOLVO				
Poz.	Tip vozila	Opis	OE broj	RAPIDEX broj
1.	FH12, FH16	MEHANIZAM BRISAČA	8191758	KABI0624
2.	FH12, FH16	MEHANIZAM BRISAČA	8143704	KABI0625
3.	FM10, FM12, FH12, FH16	METLICA BRISAČA 650 mm	20826591	KABI0426
4.	FM10, FM12, FH12, FH16	MOTOR BRISAČA	1063838	KABI0651
5.	FH12, FH16	MOTOR BRISAČA	8143408	KABI0652
6.	FM12, FH12, FH16	MOTOR BRISAČA	20442878	KABI0653
7.	FM12, FH12, FH16	MOTOR BRISAČA	20442879	KABI0654
8.	FM10, FM12, FH12, FH16	PUMPICA BRISAČA	3980681	ELEK0202
9.	FM10, FM12, FH12, FH16	RUČICA BRISAČA	8189632	KABI0645
10.	FM10, FM12, FH12, FH16	RUČICA BRISAČA	8189633	KABI0646



DAF					
Poz.	Tip vozila	Opis	Položaj	OE broj	RAPIDEX broj
1.	CF65, 75, 85, 95XF	BRAVA VRATA	◀	1296590	KABI0655
2.	CF65, 75, 85, 95XF	BRAVA VRATA	▶	1296591	KABI0656
3.	F95, 95XF, XF95, XF105	KVAKA VRATA	◀	1305481	KABI0670
4.	F95, 95XF, XF95, XF105	KVAKA VRATA	▶	1305482	KABI0671
5.	F95, 95XF, XF95, XF105	PODIZAČ PROZORA SA MOTOROM	◀	1354702	KABI0674
6.	F95, 95XF, XF95, XF105	PODIZAČ PROZORA SA MOTOROM	▶	1354703	KABI0675
7.	F95, 95XF, XF95, XF105	VENTIL GREJANJA		1331724	KABI0688

MAN					
Poz.	Tip vozila	Opis	Položaj	OE broj	RAPIDEX broj
1.	M90, F90, M2000, F2000	BRAVA VRATA	◀▶	81.97100.6099	KABI0657
2.	M90, F90, M2000, F2000	BRAVA VRATA	◀	81.62680.6095	KABI0658
3.	M90, F90, M2000, F2000	BRAVA VRATA	▶	81.62680.6096	KABI0659
4.	TGA, TGS, TGX	BRAVA VRATA	◀	81.62680.6121	KABI0660
5.	TGA, TGS, TGX	BRAVA VRATA	▶	81.62680.6122	KABI0661

MAN					
Poz.	Tip vozila	Opis	Položaj	OE broj	RAPIDEX broj
8.	TGA, TGS, TGX	MODUL VRATA	◀	81.25806.7077	KABI0027
9.	TGA, TGS, TGX	MODUL VRATA	▶	81.25806.7073	KABI0245
10.	M2000, F2000	MOTOR PODIZAČA	◀	81.28601.6069	KABI0693
11.	M2000, F2000	MOTOR PODIZAČA	▶	81.28601.6068	KABI0694
12.	TGA, TGS, TGX	MOTOR PODIZAČA	◀	81.28601.6126	KABI0001
13.	TGA, TGS, TGX	MOTOR PODIZAČA	▶	81.28601.6126	KABI0695
14.	M2000, F2000	PODIZAČ PROZORA	◀	81.62640.6055	KABI0287
15.	M2000, F2000	PODIZAČ PROZORA	▶	81.62640.6056	KABI0288
16.	TGA, TGS, TGX	PODIZAČ PROZORA ELEKTRONSKI	◀	81.62645.6035	KABI0676
17.	TGA, TGS, TGX	PODIZAČ PROZORA ELEKTRONSKI	▶	81.62645.6034	KABI0677
18.	M2000, F2000	RUČICA VRATA	◀	81.62641.0099	KABI0294
19.	M2000, F2000	RUČICA VRATA	▶	81.62641.0100	KABI0295
20.	TGA, TGS, TGX	RUČICA VRATA	◀	81.62641.6067	KABI0696
21.	TGA, TGS, TGX	RUČICA VRATA	▶	81.62641.6068	KABI0697
22.	TGA, TGS, TGX	VENTIL GREJANJA		81.61967.0016	KABI0689



MERCEDES					
Poz.	Tip vozila	Opis	Položaj	OE broj	RAPIDEX broj
1.	ACTROS KABINA 943	BRAVA VRATA	◀	943 720 06 35	KABI0662
2.	ACTROS KABINA 943	BRAVA VRATA	▶	943 720 07 35	KABI0663
3.	ACTROS KABINA 944	BRAVA VRATA	◀	973 720 07 35	KABI0664
4.	ACTROS KABINA 944	BRAVA VRATA	▶	973 720 08 35	KABI0665
5.	ACTROS	KVAKA VRATA	◀	941 760 04 59	KABI0070
6.	ACTROS	KVAKA VRATA	▶	941 760 05 59	KABI0071
7.	ACTROS	MOTOR PODIZAČA	◀	005 820 90 42	KABI0309
8.	ACTROS	MOTOR PODIZAČA	▶	005 820 91 42	KABI0310
9.	ACTROS MP2	MOTOR PODIZAČA	◀	000 820 28 08	KABI0698
10.	ACTROS MP2	MOTOR PODIZAČA	▶	000 820 29 08	KABI0699
11.	ACTROS KABINA 944	PODIZAČ PROZORA	◀	973 720 01 46	KABI0678
12.	ACTROS KABINA 944	PODIZAČ PROZORA	▶	973 720 02 46	KABI0679
13.	ACTROS KABINA 943	PODIZAČ PROZORA	◀	973 720 03 46	KABI0680
14.	ACTROS KABINA 943	PODIZAČ PROZORA	▶	973 720 04 46	KABI0046
15.	ACTROS KABINA 942/943	PODIZAČ PROZORA	◀	941 720 04 46	KABI0435
16.	ACTROS KABINA 942/943	PODIZAČ PROZORA	▶	941 720 05 46	KABI0072
17.	ACTROS KABINA 942/943	PODIZAČ PROZORA	◀	000 725 00 02	KABI0073
18.	ACTROS KABINA 942/943	PODIZAČ PROZORA	▶	000 725 01 02	KABI0681
19.	ACTROS KABINA 930/931/932/933	RUČICA VRATA	◀	941 890 04 72	KABI0700
20.	ACTROS KABINA 930/931/932/933	RUČICA VRATA	▶	941 890 05 72	KABI0701
21.	ACTROS KABINA 942	RUČICA VRATA	◀	941 720 00 66	KABI0074
22.	ACTROS KABINA 942	RUČICA VRATA	▶	941 720 01 66	KABI0075

SCANIA

Poz.	Tip vozila	Opis	Položaj	OE broj	RAPIDEX broj
1.	CP, CG, CR, CT	BRAVA VRATA	◀	1 789 311	KABI0666
2.	CP, CG, CR, CT	BRAVA VRATA	▶	1 789 312	KABI0667
3.	CP, CG, CR, CT	KVAKA VRATA	◀	1 544 330	KARO0256
4.	CP, CG, CR, CT	KVAKA VRATA	▶	1 544 331	KARO0255
5.	CP, CG, CR, CT	MOTOR PODIZAČA	◀	1 442 292	KABI0702
6.	CP, CG, CR, CT	MOTOR PODIZAČA	▶	1 442 293	KABI0703
7.	CP, CG, CR, CT	PODIZAČ PROZORA ELEKTRONSKI	◀	1 442 294	KABI0682
8.	CP, CG, CR, CT	PODIZAČ PROZORA ELEKTRONSKI	▶	1 442 295	KABI0683
9.	CP, CG, CR, CT	VENTIL GREJANJA		1 450 166	KABI0690
10.	CP, CG, CR, CT	VENTIL GREJANJA		1 741 027	KABI0691



VOLVO

Poz.	Tip vozila	Opis	Položaj	OE broj	RAPIDEX broj
1.	FH12, FH16, FM9, FM10, FM12	BRAVA VRATA	◀	1063327	KABI0668
2.	FH12, FH16, FM9, FM10, FM12	BRAVA VRATA	▶	1063328	KABI0669
3.	FH12, FH16, FM9, FM10, FM12	KVAKA VRATA	◀	20398466	KARO0202
4.	FH12, FH16, FM9, FM10, FM12	KVAKA VRATA	▶	20398467	KARO0201
5.	FH12, FH16, FM9, FM10, FM12	MODUL VRATA	◀	20752918	ELEK0191
6.	FH12, FH16, FM9, FM10, FM12	MODUL VRATA	▶	20752919	ELEK0399
7.	FH12, FH16, FM9, FM10, FM12	MOTOR PODIZAČA	◀	3176549	KABI0704
8.	FH12, FH16, FM9, FM10, FM12	MOTOR PODIZAČA	▶	3176550	KABI0705
9.	FH12, FH16	PODIZAČ PROZORA	◀	3176535	KABI0684
10.	FH12, FH16	PODIZAČ PROZORA	▶	3176536	KABI0685
11.	FH12, FH16	PODIZAČ PROZORA ELEKTRONSKI	◀	3176541	KABI0686
12.	FH12, FH16	PODIZAČ PROZORA ELEKTRONSKI	▶	3176542	KABI0687
13.	FH12, FH16, FM9, FM10, FM12	RUČICA VRATA	◀	1614564	KABI0706
14.	FH12, FH16, FM9, FM10, FM12	VENTIL GREJANJA		3093481	KABI0692



7.0 ELEKTRIČNE INSTALACIJE



7.0 ELEKTRIČNE INSTALACIJE

7.1	Farovi	552
7.2	Pokazivači pravca	573
7.3	Stop i gabaritna svetla	581
7.4	Rotacione lampe	610
7.5	Sijalice, osigurači i tahograf listići	614
7.6	Kablovi električne instalacije	620
7.7	Kombinovani prekidači pod volanom	623
7.8	Akumulatori i pribor	632
7.9	Alternatori	636
7.10	Anlaseri	642

[NAZAD NA GLAVNI SADRŽAJ](#)

DAF 65, DAF 75, DAF 85 (1993 - 1995) DAF 65CF, DAF 75CF, DAF 85CF (1998 - 2000)



OE broj	OPIS	RAPIDEX broj
1293369	H4	RASV0586
1293368	H4	RASV0587
1318140	▶ STAKLO	RASV0588
1318135	◀ STAKLO	RASV0589

DAF 95 (1987 - 1995)



OE broj	OPIS	RAPIDEX broj
0384982	H4	RASV0591
0384981	H4	RASV0592
0066693	▶ STAKLO	RASV0593
0066692	◀ STAKLO	RASV0594

DAF 95XF (1997 - 2002)



OE broj	OPIS	RAPIDEX broj
1293361	H4	RASV0476
1293360	H4	RASV0475
1318150	▶ STAKLO	RASV0596
1318149	◀ STAKLO	RASV0597

DAF CF65, CF75, CF85, LF45, LF55 (01.2001 - ...) DAF XF95 (04.1997 - 09.2002)



OE broj	OPIS	RAPIDEX broj
1328861	H1 H3	RASV0324
1328860	H1 H3	RASV0323

DAF CF65, CF75, CF85, LF45, LF55, XF95 (01.2001 - ...) DAF XF105 (2005 - ...)



OE broj	OPIS	RAPIDEX broj
1699299	H1 H7	RASV0599
1699297	H1 H7	RASV0600
1699301	H1 H7	RASV0283
1699300	H1 H7	RASV0282

DAF CF85, XF105 (2009 - ...)



OE broj	OPIS	RAPIDEX broj
1743691	D2S H1	RASV0601
1743690	D2S H1	RASV0602

DAF CF65, CF75, CF85, LF45, LF55 (01.2001 - ...) DAF XF95, XF105



OE broj	OPIS	RAPIDEX broj
1725271	H3 H3	RASV0435
1725270	H3 H3	RASV0159

IVECO DAILY (1989 - 1999)



OE broj	OPIS	RAPIDEX broj
98433943	H4	RASV0603
98433942	H4	RASV0604
98433940	H4	RASV0605
98433939	H4	RASV0606



OE broj	OPIS	RAPIDEX broj
98438671	H3	RASV0607
98438672	H3	RASV0608

IVECO DAILY (1999 - ...)

OE broj	OPIS	RAPIDEX broj
500307754	▶	RASV0609
500307755	◀	RASV0610



500320684	▶	RASV0611
500320685	◀	RASV0612

IVECO DAILY (2006 - ...)

OE broj	OPIS	RAPIDEX broj
69500010	▶	RASV0613
69500013	◀	RASV0614

IVECO EUROCARGO (1991 - 2002)

OE broj	OPIS	RAPIDEX broj
500340503	▶	RASV0615
500340543	◀	RASV0616
500340361	▶	RASV0617
500340408	◀	RASV0618

IVECO EUROCARGO, EUROSTAR, EUROTCH (1991 - 2002)

OE broj	OPIS	RAPIDEX broj
98437475	▶	RASV0619
98437476	◀	RASV0620

IVECO EUROSTAR, EUROTCH (1993 - 2002)

OE broj	OPIS	RAPIDEX broj
4861793	▶	RASV0621
4861794	◀	RASV0622
500305102	▶	RASV0017
500305103	◀	RASV0287

**IVECO EUROCARGO (2004 - ...)
IVECO STRALIS (2003 - ...)**

OE broj	OPIS	RAPIDEX broj
504020189	▶	RASV0337
504020193	◀	RASV0335
41221015	▶	RASV0336
41221036	◀	RASV0334

IVECO STRALIS (2003 - ...)

OE broj	OPIS	RAPIDEX broj
504032145	▶	RASV0018
	◀	



41221084	▶	RASV0338
	◀	

MAN F90 (1986 - 1997) MAN M90 (1988 - 1994)



OE broj	OPIS	RAPIDEX broj
81.25101.6219	▶ H4	RASV0553
81.25110.0059	▶ STAKLO STAKLO	RASV0257



81.25102.6088	▶ H3	RASV0407
---------------	--------	----------

MAN F2000 (1994 - ...) MAN M2000 (1995 - ...)



OE broj	OPIS	RAPIDEX broj
81.25101.6292	▶ H7	RASV0429
81.25101.6291	◀ H7	RASV0430
81.25110.0068	▶ STAKLO STAKLO	RASV0256
81.25110.0067	◀ STAKLO STAKLO	RASV0380



81.25101.6338	▶ H3	RASV0022
81.25101.6339	◀ H3	RASV0023



MAN TGA (1999 - ...), MAN M2000 (2002 - 2005) MAN LE (2001 - 2005), MAN TGL, TGM (2005 - ...)



OE broj	OPIS	RAPIDEX broj
81.25101.6348	▶ H7	RASV0064
81.25101.6347	◀ H7	RASV0065
81.52101.6352	▶ H7	RASV0510
81.52101.6351	◀ H7	RASV0509
81.25110.0081	▶ STAKLO STAKLO	RASV0041
81.25110.0080	◀ STAKLO STAKLO	RASV0040



81.25320.6092	▶ H4	RASV0003
81.25320.6091	◀ H4	RASV0002



81.25320.6114	▶ H4	RASV0623
81.25320.6113	◀ H4	RASV0624



81.25320.6090	▶ H4	RASV0061
81.25320.6089	◀ H4	RASV0062

MAN TGX, TGS



OE broj	OPIS	RAPIDEX broj
81.25101.6500	▶ H7	RASV0009
81.25101.6501	◀ H7	RASV0010
81.25101.6498	▶ H7	RASV0625
81.25101.6499	◀ H7	RASV0626
81.25110.0084	▶ STAKLO STAKLO	RASV0627
81.25110.0083	◀ STAKLO STAKLO	RASV0628

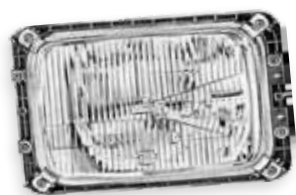

81.25101.6522	▶ H4	RASV0629
81.25101.6521	◀ H4	RASV0630

MERCEDES 207D - 410D (1980 - 1995)

OE broj	OPIS	RAPIDEX broj
000 820 73 61	▶ H4	RASV0631
000 820 72 61	◀ H4	RASV0632
000 826 67 90	▶ STAKLO	RASV0633
000 826 66 90	◀ STAKLO	RASV0634

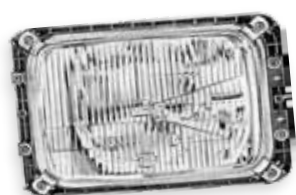
MERCEDES 207D - 410D (1980 - 1995)

OE broj	OPIS	RAPIDEX broj
001 820 22 61	▶ H4	RASV0205
001 820 21 61	◀ H4	RASV0201
002 826 99 90	▶ STAKLO	RASV0635
002 826 98 90	◀ STAKLO	RASV0636

MERCEDES SPRINTER (1995 - 2000)

OE broj	OPIS	RAPIDEX broj
901 820 06 61	▶ H1 H1 H1	RASV0409
901 820 05 61	◀ H1 H1 H1	RASV0408
901 820 02 61	▶ H1 H1	RASV0637
901 820 01 61	◀ H1 H1	RASV0638
000 820 17 66	▶ STAKLO	RASV0639
000 820 16 66	◀ STAKLO	RASV0640

MERCEDES SPRINTER (2000 - 2002)

OE broj	OPIS	RAPIDEX broj
901 820 15 61	▶ H7 H1 H1	RASV0641
901 820 14 61	◀ H7 H1 H1	RASV0642
901 820 11 61	▶ H7 H1	RASV0254
901 820 10 61	◀ H7 H1	RASV0523

MERCEDES SPRINTER (2002 - 2004)

OE broj	OPIS	RAPIDEX broj
901 820 27 61	▶ H7 H3 H3	RASV0328
901 820 26 61	◀ H7 H3 H3	RASV0327
901 820 25 61	▶ H7 H3	RASV0643
901 820 24 61	◀ H7 H3	RASV0644

MERCEDES SPRINTER (2005 - ...)

OE broj	OPIS	RAPIDEX broj
906 820 02 61	▶ H7 H7	RASV0645
906 820 01 61	◀ H7 H7	RASV0646

MERCEDES SPRINTER (2005 - ...)

OE broj	OPIS	RAPIDEX broj
211 820 06 56	▶ H11	RASV0647
211 820 05 56	◀ H11	RASV0648

MERCEDES VARIO (1996 - ...)

OE broj	OPIS	RAPIDEX broj
670 820 06 61	▶ H1	RASV0649
670 820 05 61	◀ H1	RASV0650

MERCEDES MK, SK (1988 ...)

OE broj	OPIS	RAPIDEX broj
381 820 44 61	▶ H4	RASV0580
381 820 43 61	◀ H4	RASV0581
000 826 07 90	▶ STAKLO	RASV0578
000 826 06 90	◀ STAKLO	RASV0579



002 820 37 56	▶ H3	RASV0651
002 820 39 56	◀ H3	RASV0652

MERCEDES ATEGO I (1998 - 2004)

OE broj	OPIS	RAPIDEX broj
973 820 02 61	▶ H4	RASV0653
973 820 01 61	◀ H4	RASV0654
973 820 06 61	▶ H4 H1	RASV0330
973 820 05 61	◀ H4 H1	RASV0329
004 826 12 90	▶ STAKLO	RASV0016
004 826 13 90	◀ STAKLO	RASV0655

MERCEDES ATEGO II (2004 - ...)



OE broj	OPIS	RAPIDEX broj
973 820 23 61	▶ H7 H1	RASV0656
973 820 22 61	◀ H7 H1	RASV0657
973 820 25 61	▶ H7 H1	RASV0658
973 820 24 61	◀ H7 H1	RASV0659
000 826 45 10	▶ STAKLO	RASV0660
000 826 44 10	◀ STAKLO	RASV0661

MERCEDES AXOR II (2004 - ...)

OE broj	OPIS	RAPIDEX broj
940 820 02 61	▶ H7 H1	RASV0662
940 820 01 61	◀ H7 H1	RASV0663
000 826 43 10	▶ STAKLO	RASV0341
000 826 42 10	◀ STAKLO	RASV0664

MERCEDES AXOR II (2004 - ...)

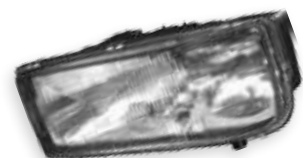
OE broj	OPIS	RAPIDEX broj
943 820 01 56	▶ H3	RASV0332
943 820 00 56	◀ H3	RASV0331

**MERCEDES ACTROS (1996 - 2003)
MERCEDES AXOR I (2001 - 2004)**

OE broj	OPIS	RAPIDEX broj
941 820 58 61	▶ H4	RASV0665
941 820 57 61	◀ H4	RASV0666
941 820 52 61	▶ H4 H1	RASV0339
941 820 51 61	◀ H4 H1	RASV0333
941 820 60 61	▶ H4 H1	RASV0667
941 820 59 61	◀ H4 H1	RASV0668



941 820 54 61	▶ H4	RASV0346
941 820 53 61	◀ H4	RASV0345
941 820 56 61	▶ H4	RASV0669
941 820 55 61	◀ H4	RASV0670

004 826 07 90	▶ STAKLO	RASV0470
004 826 06 90	◀ STAKLO	RASV0342



002 820 59 56	▶ H3	RASV0671
002 820 58 56	◀ H3	RASV0672
002 820 52 56	▶ H3	RASV0673
002 820 45 56	◀ H3	RASV0674



002 820 77 56	▶ H3	RASV0285
002 820 76 56	◀ H3	RASV0284
002 820 85 56	▶ H3	RASV0179
002 820 84 56	◀ H3	RASV0176
000 826 18 59	▶	RASV0174
000 826 17 59	◀	RASV0210

MERCEDES ACTROS (2003 - ...)

OE broj	OPIS	RAPIDEX broj
943 820 02 61	▶ H7 H1	RASV0049
943 820 01 61	◀ H7 H1	RASV0093
943 820 04 61	▶ H7 H1	RASV0676
943 820 03 61	◀ H7 H1	RASV0677



943 820 01 56	▶ H3	RASV0332
943 820 00 56	◀ H3	RASV0331

MERCEDES ACTROS (2008 - ...)

OE broj	OPIS	RAPIDEX broj
943 820 17 61	▶ H7 H1	RASV0678
943 820 16 61	◀ H7 H1	RASV0679
943 820 23 61	▶ XENON D2R H1	RASV0680
943 820 22 61	◀ XENON D2R H1	RASV0681
000 826 47 10	▶ STAKLO	RASV0048
000 826 46 10	◀ STAKLO	RASV0047

RENAULT PREMIUM (1996 - 2005)

OE broj	OPIS	RAPIDEX broj
5010392466	▶ H1 H1	RASV0682
5010392465	◀ H1 H1	RASV0683



5010231850	▶ H1 H1	RASV0684
5010231849	◀ H1 H1	RASV0685

RENAULT PREMIUM (2005 - ...)

OE broj	OPIS	RAPIDEX broj
5010578466	▶	RASV0686
5010578442	◀	RASV0687
5010578478	▶	RASV0688
5010578454	◀	RASV0689

RENAULT MAGNUM (2001 - ...)

OE broj	OPIS	RAPIDEX broj
5110623619	▶	RASV0690
5110623620	◀	RASV0691
5010312972	▶	RASV0692

SCANIA SERIJA 4 (1996 - ...)

OE broj	OPIS	RAPIDEX broj
1 431 257	▶	RASV0063
1 431 256	◀	RASV0019
1 446 584	▶ STAKLO	RASV0468
1 446 583	◀ STAKLO	RASV0158



1 529 071	▶	RASV0348
1 529 070	◀	RASV0286

SCANIA SERIJA P, SERIJA R, SERIJA T (2007 - ...)



OE broj	OPIS	RAPIDEX broj
1 760 554	▶	RASV0693
1 760 551	◀	RASV0964

SCANIA SERIJA P, SERIJA R, SERIJA T (2004 - ...)

OE broj	OPIS	RAPIDEX broj
1 446 356	▶	RASV0020
1 446 355	◀	RASV0021
1 446 354	▶	RASV0326
1 446 353	◀	RASV0325

VOLVO F, FL, FS (1985 - ...)

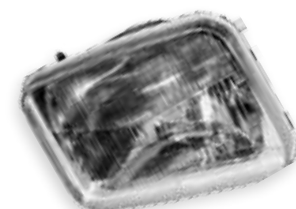
OE broj	OPIS	RAPIDEX broj
6793924	▶	RASV0695

VOLVO FH12, FH16 (1997 - 2001)

OE broj	OPIS	RAPIDEX broj
3981594	▶	RASV0259

VOLVO FH12, FH16 (1993 - 2001)

OE broj	OPIS	RAPIDEX broj
3980335	▶ H3	RASV0322
3980334	◀ H3	RASV0321

VOLVO FH, FM (1998 - ...)

OE broj	OPIS	RAPIDEX broj
1062190	▶ H3	RASV0508

VOLVO FH, FM (2002 - ...)

OE broj	OPIS	RAPIDEX broj
20861584	▶ H7	RASV0320
20861583	◀ H7	RASV0319
20379429	▶ STAKLO	RASV0386
20379428	◀ STAKLO	RASV0385

VOLVO FH (2008 - ...)

OE broj	OPIS	RAPIDEX broj
21035637	▶ H7	RASV0901
21035638	◀ H7	RASV0902
21035690	▶ H3	RASV0903
21035692	◀ H3	RASV0904

VOLVO FE, FL (2006 - ...)

OE broj	OPIS	RAPIDEX broj
20818775	▶ H4	RASV0696
20818776	◀ H4	RASV0697



20779458	▶ H11	RASV0698
----------	--------	----------

MERCEDES TRAVEGO (1999 - ...)

OE broj	OPIS	RAPIDEX broj
000 540 02 54	▶ H7 H1	RASV0703
000 540 01 54	◀ H7 H1	RASV0704



000 540 01 63	▶ H1	RASV0705
000 540 00 63	◀ H1	RASV0706

MERCEDES EVOBUS CITARO (1998 - ...)

OE broj	OPIS	RAPIDEX broj
002 820 22 61	▶ H1 H1	RASV0707
002 820 21 61	◀ H1 H1	RASV0708

MERCEDES EVOBUS

OE broj	OPIS	RAPIDEX broj
000 540 05 54	▶ H1	RASV0709
000 545 04 54	◀ H1	RASV0710

MERCEDES O404, TOURISMO O350 (1991 - 2003)

OE broj	OPIS	RAPIDEX broj
356 820 02 61	▶ H3 H3 H1	RASV0699
356 820 01 61	◀ H3 H3 H1	RASV0700
003 826 87 90	▶ STAKLO	RASV0701
003 826 89 90	◀ STAKLO	RASV0702

MERCEDES O403, TOURISMO

OE broj	OPIS	RAPIDEX broj
613 820 01 61	▶ E H3 H7	RASV0905
613 820 00 61	◀ E H3 H7	RASV0906

KÄSSBOHRER SETRA S200 - 228 (1979 - 1996)

OE broj	OPIS	RAPIDEX broj
7512123000	▶ M H4	RASV0714
7512122000	◀ M H4	RASV0715

KÄSSBOHRER SETRA S309 (1991 - ...)

OE broj	OPIS	RAPIDEX broj
627 540 01 54	▶ E H1 H1	RASV0716
627 540 00 54	◀ E H1 H1	RASV0717

NEOPLAN

OE broj	KBP	OPIS	RAPIDEX broj
70305312	1BL 007 834-047	▶ H1 ◀ H1 150 x 150 mm	RASV0711



70305313	1KL 007 834-027	▶ H1 ◀ H1 150 x 150 mm	RASV0712
----------	-----------------	--------------------------------	----------



150324500	1NL 007 834-017	▶ H1 ◀ H1 150 x 150 mm	RASV0713
-----------	-----------------	--------------------------------	----------

NEOPLAN, KÄSSBOHRER, VOLVO

OE broj	KBP	OPIS	RAPIDEX broj
1450245	1NL 007 186-047	▶ H3 ◀ H3 Ø 88 mm	RASV0208



11073767	1NO 008 582-017	▶ H7 ◀ H7 Ø 90 mm	RASV0377
----------	-----------------	---------------------------	----------



11073768	1BL 008 193-017	▶ H7 ◀ H7 Ø 90 mm	RASV0206
----------	-----------------	---------------------------	----------



11073764	1KO 008 191-027	▶ H7 ◀ H7 Ø 90 mm	RASV0209
----------	-----------------	---------------------------	----------

UNIVERZALNI FAR

KBP	OPIS	RAPIDEX broj
44.124.000	 SIJALICA R2 Ø155 mm	RASV0279

UNIVERZALNI FAR

KBP	OPIS	RAPIDEX broj
1G3 005 760-021	 Ø152 mm	RASV0718

UNIVERZALNI FAR

KBP	OPIS	RAPIDEX broj
1GA 005 060-001	 153 x 93 mm	RASV0230

UNIVERZALNI FAR

KBP	OPIS	RAPIDEX broj
1GA 006 991-021	 158 x 105 mm	RASV0719

UNIVERZALNI FAR

KBP	OPIS	RAPIDEX broj
1GA 006 991-081 44.120.000	 112 x 102mm	RASV0168

UNIVERZALNI FAR

KBP	OPIS	RAPIDEX broj
1AB 006 213-001	 182 x 102 mm	RASV0720

UNIVERZALNI FAR

KBP	OPIS	RAPIDEX broj
1EA 007 108-021	 247 x 163 mm	RASV0721
1EA 007 108-011		RASV0722

UNIVERZALNI FAR

KBP	OPIS	RAPIDEX broj
1EA 993 975-021	 212 x 165 mm	RASV0031
1EA 993 975-011		RASV0032

UNIVERZALNI FAR

KBP	OPIS	RAPIDEX broj
44.040.500	 H3 170 x 100 mm	RASV0167

PRO-XENON UNIVERZALNI FAR

KBP	OPIS	RAPIDEX broj
40 456 003	 XENON, 12/24V, 35W 210 x 121 mm	RASV0723

PRO-XENON UNIVERZALNI FAR

KBP	OPIS	RAPIDEX broj
40 459 003	 XENON, 9 - 32V, 35W 153,5 x 130,5 mm	RASV0724

PRO-XENON UNIVERZALNI FAR

KBP	OPIS	RAPIDEX broj
40 458 003	 XENON, 12/24V, 35W 161 x 150 mm	RASV0725

DAF 95 (1987-1997)

OE broj	OPIS	RAPIDEX broj
0066698		RASV0170

DAF 95XF (1997 - 2002)

OE broj	OPIS	RAPIDEX broj
1301368		RASV0726

IVECO EUROCAGO (1991 - 2002)

OE broj	OPIS	RAPIDEX broj
4855967		RASV0727
4855968		RASV0728

500340695		RASV0729
500340696		RASV0730

IVECO EUROCARGO (2003 - ...)

OE broj	OPIS	RAPIDEX broj
504047573		RASV0731

IVECO EUROCARGO, STRALIS (2007 - ...)

OE broj	OPIS	RAPIDEX broj
42555041		RASV0907
42555042		RASV0908

IVECO EUROSTAR (1993 - 2002)

OE broj	OPIS	RAPIDEX broj
98449181	▶ ↔	RASV0732
98449182	◀ ↔	RASV0733

IVECO STRALIS (2003 - ...)

OE broj	OPIS	RAPIDEX broj
41221040	▶ ↔	RASV0100
41221041	◀ ↔	RASV0101

**MAN F90 (1986 - 1997)
MAN M90 (1988 - 1994)**

OE broj	OPIS	RAPIDEX broj
81.25320.6068	▶ ↔	RASV0289
	◀ ↔	

MAN L2000 (1993 - ...)

OE broj	OPIS	RAPIDEX broj
81.25320.6073	▶ ↔	RASV0288
	◀ ↔	

**MAN F2000 (1994 - ...)
MAN M2000 (1995 - ...)**

OE broj	OPIS	RAPIDEX broj
81.25320.6084	▶ ↔	RASV0734
	◀ ↔	

MERCEDES SPRINTER (1995 - 2000)



OE broj	OPIS	RAPIDEX broj
901 820 02 21	▶ ↔	RASV0089
901 820 01 21	◀ ↔	RASV0088

MERCEDES ATEGO I (1998 - 2004)

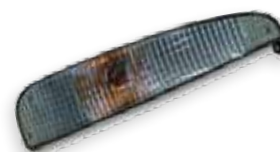

OE broj	OPIS	RAPIDEX broj
973 820 02 21	▶ ↔	RASV0015
973 820 01 21	◀ ↔	RASV0033

MERCEDES ATEGO II (2004 - ...)

OE broj	OPIS	RAPIDEX broj
973 820 06 21	▶ ↔	RASV0122
973 820 05 21	◀ ↔	RASV0121

MERCEDES AXOR II (2004 - ...)

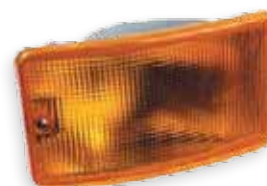
OE broj	OPIS	RAPIDEX broj
940 820 04 21	▶ ↔	RASV0735
940 820 03 21	◀ ↔	RASV0736

**MERCEDES ACTROS (1996 - 2003)
MERCEDES AXOR I (2001 - 2004)**

OE broj	OPIS	RAPIDEX broj
941 820 07 21	▶ ↔	RASV0737
	◀ ↔	

RENAULT PREMIUM (1996 - 2005)

OE broj	OPIS	RAPIDEX broj
5001834559	▶ ↔	RASV0738
5001834560	◀ ↔	RASV0739

SCANIA SERIJA 4 (1996 - ...)

OE broj	OPIS	RAPIDEX broj
1 387 155	▶ ↔	RASV0357
1 385 410	◀ ↔	RASV0368

SCANIA SERIJA P, R, T (2004 - ...)

OE broj	OPIS	RAPIDEX broj
1 747 981	▶ ↔	RASV0157

VOLVO FH12, FH16 (1993 - 2001)

OE broj	OPIS	RAPIDEX broj
3981666	▶ ↔	RASV0740



OE broj	OPIS	RAPIDEX broj
3981668	▶ ↔	RASV0290

DAF LF (2001 - ...)

OE broj	OPIS	RAPIDEX broj
1626101	▶ ↔	RASV0073

IVECO EURO CARGO (1991 - ...)

OE broj	OPIS	RAPIDEX broj
500316547	▶ ↔	RASV0741

IVECO EURO CARGO (2003 - ...)

OE broj	OPIS	RAPIDEX broj
500367925	▶ ↔	RASV0742

IVECO EURO TECH

OE broj	OPIS	RAPIDEX broj
500368110	▶ ↔	RASV0743
500368111	◀ ↔	RASV0744

IVECO STRALIS (2003 - ...)

OE broj	OPIS	RAPIDEX broj
41221029	▶ ↔	RASV0160
41221039	◀ ↔	RASV0161

**MAN F2000 (1994 - ...)
MAN M2000 (1995 - ...)**

OE broj	OPIS	RAPIDEX broj
81.2530.6082		RASV0173

**MAN TGA (1999 - ...)
M2000 (2002 - 2005), LE (2001 - 2005), TGL, TGM (2005 - ...)**

OE broj	OPIS	RAPIDEX broj
81.25320.6115		RASV0067

MERCEDES MK, SK (1988 - ...)

OE broj	OPIS	RAPIDEX broj
001 820 44 21		RASV0370
001 820 43 21		RASV0745

MERCEDES ATEGO I 1998 - 2004

OE broj	OPIS	RAPIDEX broj
973 820 04 21		RASV0507
973 820 03 21		RASV0066



OE broj	OPIS	RAPIDEX broj
941 820 10 21		RASV0746

MERCEDES AXOR (2002 - ...)

OE broj	OPIS	RAPIDEX broj
940 820 02 21		RASV0178

MERCEDES ACTROS (1996 - 2003)

OE broj	OPIS	RAPIDEX broj
941 820 09 21		RASV0354
941 820 05 21		RASV0353



OE broj	OPIS	RAPIDEX broj
942 820 09 21		RASV0115
941 820 05 21		RASV0175

RENAULT PREMIUM (1996 - 2005)

OE broj	OPIS	RAPIDEX broj
5001834565		RASV0072

SCANIA SERIJA R, P (2007 - ...)

OE broj	OPIS	RAPIDEX broj
1 770 301		RASV0747

VOLVO FL (2000 - ...)



OE broj	OPIS	RAPIDEX broj
35.802.122		RASV0748



OE broj	OPIS	RAPIDEX broj
20733983		RASV0073

VOLVO FH (2003 - ...), FL (2001 - ...)



OE broj	OPIS	RAPIDEX broj
20409874		RASV0076
20409875		RASV0077

VOLVO FH (2008 - ...)



OE broj	OPIS	RAPIDEX broj
82114500	LED	RASV0909
82114506	LED	RASV0910

OE broj	OPIS	RAPIDEX broj
82114502	LED	RASV0911
82114504	CRNO KUĆIŠTE	RASV0912

IVECO, MAN, MERCEDES



OE broj	OPIS	RAPIDEX broj
2SD001699061		RASV0440
2SE001699071	282 x 105 mm	RASV0439
9EL109139001	▶ STAKLO ◀ STAKLO	RASV0393



OE broj	OPIS	RAPIDEX broj
2SD003167011		RASV0437
2SE003016031	344 x 147 mm	RASV0434
9EL118445001	▶ STAKLO ◀ STAKLO	RASV0253

DAF 65, 75, 85 (1993 - 1998), DAF 95 (1987 - 1997)

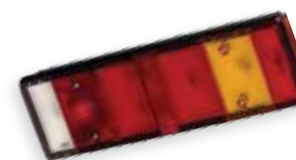

OE broj	OPIS	RAPIDEX broj
1626320		RASV0302
1626319	468 x 134 mm	RASV0301
1272653	▶ STAKLO ◀ STAKLO	RASV0306

DAF CF, XF (1997 - ...)



OE broj	OPIS	RAPIDEX broj
1625986		RASV0311
1625985	468 x 134 mm	RASV0299
1272653	▶ STAKLO ◀ STAKLO	RASV0306

DAF LF (2001 - ...)

OE broj	OPIS	RAPIDEX broj
1401713	▶ 350 x 133 mm	RASV0224
1401731	◀ 350 x 133 mm	RASV0223
1451482	▶ STAKLO ◀ STAKLO	RASV0369

IVECO EURO CARGO, EURO STAR, EURO TECH, EURO TRAKKER, STRALIS

OE broj	OPIS	RAPIDEX broj
99463242	▶ 468 x 134 mm	RASV0503
99463244	◀ 468 x 134 mm	RASV0479
93161844	▶ STAKLO ◀ STAKLO	RASV0247

MAN M90 (1988 - 1991), MAN F90 (1986 - 1991)

OE broj	OPIS	RAPIDEX broj
81.25229.6010	▶ 343 x 133 mm	RASV0219
81.25229.6011	◀ 343 x 133 mm	RASV0220
81.25229.6040	▶ STAKLO ◀ STAKLO	RASV0487

MAN L2000 (1993 - ...), M2000 (1995 - ...), F90 (1991 - ...), F2000 (1994 - ...)

OE broj / KBP	OPIS	RAPIDEX broj
81.25228.6030	▶ 468 x 134 mm	RASV0249
81.25228.6029	◀ 468 x 134 mm	RASV0248



2VP008204121	▶ 468 x 134 mm	RASV0419
2VD008204131	◀ 468 x 134 mm	RASV0418

81.25229.6051	▶ STAKLO ◀ STAKLO	RASV0247
---------------	----------------------	----------

MAN TGA (2000 - ...)



OE broj	OPIS	RAPIDEX broj
81.25225.6523	▶ 468 x 134 mm	RASV0228
81.25225.6524	◀ 468 x 134 mm	RASV0244
81.25225.6530	▶ SA RIKVERC ALARMOM	RASV0749
81.25229.6051	▶ STAKLO ◀ STAKLO	RASV0247

MAN TGA (2000 - ...), TGL, TGM (2005 - ...)

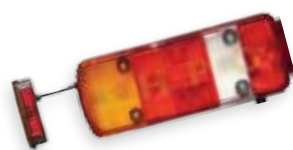

OE broj	OPIS	RAPIDEX broj
81.25225.6545	▶ 400 x 160 mm	RASV0451
81.25225.6544	◀ 400 x 160 mm	RASV0454
81.25225.6547	▶ SA RIKVERC ALARMOM	RASV0750
81.25229.6060	▶ STAKLO	RASV0388
81.25229.6059	◀ STAKLO	RASV0465

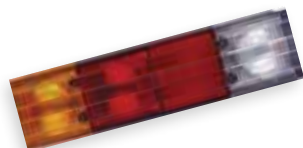
MAN TGA (2003 - ...)

OE broj	OPIS	RAPIDEX broj
81.25225.6532	▶ 340 x 130 mm	RASV0751
81.25225.6531	◀ 340 x 130 mm	RASV0752
81.25225.6538	▶ STAKLO	RASV0753
	◀ STAKLO	

MERCEDES 208D - 410D, 507D - 814D

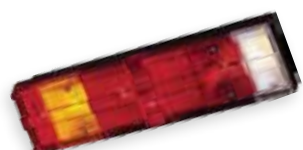
OE broj	OPIS	RAPIDEX broj
002 544 08 03	▶ 425 x 110 mm	RASV0124
002 544 09 03	◀ 425 x 110 mm	RASV0754

MERCEDES SPRINTER (1995 - ...)

OE broj	OPIS	RAPIDEX broj
002 544 54 03	▶ 465 x 134 mm	RASV0243
002 544 55 03	◀ 465 x 134 mm	RASV0242
002 544 47 90	▶ STAKLO	RASV0239
	◀ STAKLO	

MERCEDES SPRINTER (2006 - ...)

OE broj	OPIS	RAPIDEX broj
906 820 17 64	▶ 400 x 160 mm	RASV0298
906 820 04 64	◀ 400 x 160 mm	RASV0755
906 826 21 56	▶ STAKLO	RASV0305
906 826 20 56	◀ STAKLO	RASV0297

MERCEDES MK, SK (1988 - ...)

OE broj	OPIS	RAPIDEX broj
001 540 20 70	▶ 525 x 139 mm	RASV0397
001 540 17 70	◀ 525 x 139 mm	RASV0225
002 544 07 90	▶ STAKLO	RASV0250
002 544 06 90	◀ STAKLO	RASV0473

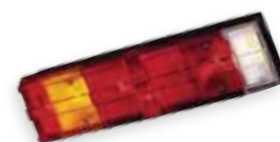
MERCEDES ATEGO I (1998 - 2004)

OE broj	OPIS	RAPIDEX broj
003 544 54 03	▶ 465 x 134 mm	RASV0241
003 544 53 03	◀ 465 x 134 mm	RASV0240
002 544 47 90	▶ STAKLO	RASV0239
	◀ STAKLO	



MERCEDES ATEGO II (2005 - ...)

OE broj	OPIS	RAPIDEX broj
002 544 71 03	▶ 340 x 130 mm	RASV0756
002 544 70 03	◀ 340 x 130 mm	RASV0757
002 544 61 90	▶ STAKLO	RASV0758
	◀ STAKLO	



MERCEDES ACTROS (1996 - ...), AXOR (2001 - ...)

OE broj	OPIS	RAPIDEX broj
001 540 58 70	▶ 525 x 139 mm	RASV0252
001 540 57 70	◀ 525 x 139 mm	RASV0251
002 544 07 90	▶ STAKLO	RASV0250
002 544 06 90	◀ STAKLO	RASV0473



RENAULT PREMIUM, MAGNUM (1998 - 2004)

OE broj	OPIS	RAPIDEX broj
5001847585	▶ 	RASV0228
5001847584	◀  465 x 134 mm	RASV0244
5001847588	▶ STAKLO  ◀ STAKLO	RASV0247



RENAULT PREMIUM (1996 - ...)



OE broj	OPIS	RAPIDEX broj
5001858092	▶ 	RASV0224
5001846847	◀  350 x 130 mm	RASV0223
5001847153	▶ STAKLO  ◀ STAKLO	RASV0369





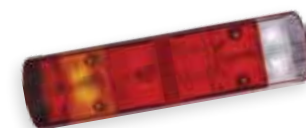

RENAULT MAGNUM (2006 - ...)

OE broj	OPIS	RAPIDEX broj
7420802350	▶ 	RASV0309
7420802348	◀  500 x 130 mm	RASV0310
7420802353	▶ SA RIKVERC ALARMOM	RASV0759
7420802418	▶ STAKLO  ◀ STAKLO	RASV0308



SCANIA SERIJA 3 (1988 - 1995)

OE broj	OPIS	RAPIDEX broj
1 365 964	▶ 	RASV0478
1 365 963	◀  468 x 134 mm	RASV0477
1 350 343	▶ STAKLO  ◀ STAKLO	RASV0247

SCANIA SERIJA 4 (1996 - ...), SERIJA R (2004 - ...)

OE broj	OPIS	RAPIDEX broj
1 371 975	▶ 	RASV0448
1 371 974	◀  510 x 136 mm	RASV0446
1 498 103	▶  	RASV0165
1 498 102	◀   510 x 136 mm	RASV0166
1 380 819	▶ STAKLO  ◀ STAKLO	RASV0226



1 756 751	▶ 	RASV0295
1 756 754	◀  400 x 160 mm	RASV0296
1 791 369	▶ SA RIKVERC ALARMOM	RASV0760
1 784 670	▶ STAKLO 	RASV0305
1 784 669	◀ STAKLO	RASV0297



VOLVO FL, F10, F12, F16 (1985 - 1999), FM (1993 - 1997)

OE broj	OPIS	RAPIDEX broj
1620479	▶ 430 x 125 mm	RASV0433
1620476	◀ 430 x 125 mm	RASV0432
1620480	▶ STAKLO ◀ STAKLO	RASV0431

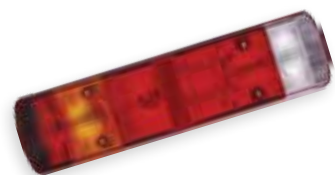

8191748	▶ 468 x 134 mm	RASV0246
8191747	◀ 468 x 134 mm	RASV0245
1350343	▶ STAKLO ◀ STAKLO	RASV0247

VOLVO FH12, FH16 (1993 - ...), FM (1998 - 2002)

OE broj	OPIS	RAPIDEX broj
3981456	▶ 510 x 136 mm	RASV0542
3981455	◀ 510 x 136 mm	RASV0489
3981782	▶ STAKLO ◀ STAKLO	RASV0226

VOLVO FH, FM, FL (2002 - ...)

OE broj	OPIS	RAPIDEX broj
20425729	▶ 370 x 130 mm	RASV0404
20425728	◀ 370 x 130 mm	RASV0405
20425730	▶ SA RIKVERC ALARMOM	RASV0761
20425732	▶ STAKLO ◀ STAKLO	RASV0497

VOLVO FL (2006 - ...)

OE broj	OPIS	RAPIDEX broj
20802350	▶ 510 x 130 mm	RASV0309
20802346	◀ 510 x 130 mm	RASV0310
20802353	▶ SA RIKVERC ALARMOM	RASV0762
20802418	▶ STAKLO ◀ STAKLO	RASV0308



20769781	▶ 350 x 130 mm	RASV0763
20745060	▶ STAKLO ◀ STAKLO	RASV0369

VOLVO FH, FL, FM (2004 - ...)

OE broj	OPIS	RAPIDEX broj
20565106	▶ 500 x 130 mm	RASV0164
20565103	◀ 500 x 130 mm	RASV0163
20565104	▶ SA RIKVERC ALARMOM	RASV0764
20565107	▶ STAKLO ◀ STAKLO	RASV0765



EUROPOINT I

OE broj	OPIS	RAPIDEX broj
25-5500-507	▶ 422 x 148 mm sa svetlom registarske tablice	RASV0403
25-5101-507	◀	RASV0402
25-5400-507	▶ 422 x 148 mm sa svetlom registarske tablice	RASV0238
25-5001-507	◀	RASV0237
18-8550-002	▶ STAKLO ◀ STAKLO	RASV0235

EUROPOINT II

OE broj	OPIS	RAPIDEX broj
25-6400-507	▶ 420 x 148 mm	RASV0006
25-6000-507	◀	RASV0007
25-6401-507	▶ 420 x 148 mm sa svetlom registarske tablice	RASV0766
25-6001-507	◀	RASV0496
25-6600-507	▶ 420 x 148 mm	RASV0095
25-6200-507	◀	RASV0094

EUROPINT II LED

OE broj	OPIS	RAPIDEX broj
25-6400-707	▶ LED 420 x 148 mm	RASV0767
25-6000-707	◀	RASV0768
25-6401-707	▶ LED 420 x 148 mm sa svetlom registarske tablice	RASV0769
25-6001-707	◀	RASV0770
18-8560-002	▶ STAKLO ◀ STAKLO	RASV0005

ECOPOINT I

OE broj	OPIS	RAPIDEX broj
25-2600-007	▶ 344 x 140 mm	RASV0771
25-2200-007	◀	RASV0772
25-2611-007	▶ 344 x 140 mm	RASV0012
25-2211-007	◀	RASV0011
18-8522-002	▶ STAKLO ◀ STAKLO	RASV0144

ECOPOINT II

OE broj	OPIS	RAPIDEX broj
25-2900-507	▶ 350 x 135 mm	RASV0773
25-2800-507	◀	RASV0774
25-2910-507	▶ 350 x 135 mm	RASV0775
25-2810-507	◀ SA GABARITOM	RASV0776
18-8529-002	▶ STAKLO	RASV0777
18-8528-002	◀ STAKLO	RASV0935

KÖGEL, SCHMITZ CARGOBULL

OE broj	KBP	OPIS	RAPIDEX broj
333477.062774	2SK 340 101-001	▶ 439 x 130 mm ◀ 1,7 m kabla	RASV0236
00040073	2SK 340 101-021	▶ ◀	RASV0779
324945.062447	9EL 340 201-001	▶ STAKLO ◀ STAKLO	RASV0520

KÖGEL

OE broj	KBP	OPIS	RAPIDEX broj
69060	2VP340450141	▶ 440 x 148 mm	RASV0107
69061	2VP340450151	◀ 1,7 m kabla	RASV0780
69062	9EL340208021	▶ STAKLO ◀ STAKLO	RASV0781

KÖGEL

OE broj	KBP	OPIS	RAPIDEX broj
6604568	40 275 412	▶ 534 x 130 mm	RASV0131
6604569	40 275 411	◀ LED	RASV0130
-	40 275 212	▶	RASV0782
-	42 275 211	◀	RASV0783



6604331	2VP340942111	▶ 534 x 130 mm	RASV0051
6604332	2VP340942101	◀ LED	RASV0050

-	40 275 112	▶ STAKLO	RASV0136
-	40 275 111	◀ STAKLO	RASV0137

KRONE, SCHMITZ CARGOBULL

OE broj	KBP	OPIS	RAPIDEX broj
5814099.062761	2VP 007 907-041	▶ 425 x 143 mm	RASV0785
5814098.062761	2VP 007 907-031	◀	RASV0786
063106	9EL 150 966-001	▶ STAKLO	RASV0787
063107	9EL 150 965-001	◀ STAKLO	RASV0788

KRONE, SCHMITZ CARGOBULL

OE broj	KBP	OPIS	RAPIDEX broj
5358171	40 242 612	▶ 440 x 148 mm	RASV0128
5358170	40 242 611	◀	RASV0127
5870268	40 242 112	▶ STAKLO ◀ STAKLO	RASV0129

KRONE

OE broj	KBP	OPIS	RAPIDEX broj
1524695	40 256 412	▶ 370 x 130 mm	RASV0789
1524694	40 256 411	◀	RASV0790
	40 256 212	▶	RASV0135
	40 256 211	◀	RASV0134
	40 256 112	▶ STAKLO	RASV0136
	40 256 111	◀ STAKLO	RASV0137

UNIVERZALNE LAMPE

OE broj	KBP	OPIS	RAPIDEX broj
001 820 89 21 88.25225.6026	2BA 008 221-007	▶	RASV0207
36.25320.6001 1 479 891	2BA 008 221-047	◀	RASV0218









36.25225.6000	2XA 008 221-027	▶	RASV0913
36.25225.6001 20557172	2NE 008 221-037	◀	RASV0914







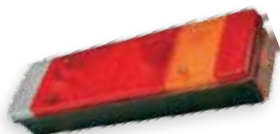

36.25260.6000 11080468	2PF 008 221-017	▶	RASV0915
36.25103.6000 70347704	2ZR 008 221-057	▶ ◀ RIKVERC	RASV0232





UNIVERZALNE STOP LAMPE





KBP	OPIS	RAPIDEX broj
2SD 001 685-211	▶  Ø140 mm ◀ 	RASV0791
2SE 001 685-201	▶  svetlo registar tablice ◀ 	RASV0004
9EL 113 324-001	▶ STAKLO  ◀ STAKLO 	RASV0792











38.414.000	▶  Ø140 mm ◀  LED	RASV0793
------------	--	----------

168790	▶  468 x 134 mm	RASV0794
168770	◀ 	RASV0795
067600	▶ STAKLO 	RASV0796
067610	◀ STAKLO 	RASV0797

153000	▶  350 x 130 mm	RASV0798
153010	◀ 	RASV0799
053700	▶ STAKLO 	RASV0800
053710	◀ STAKLO 	RASV0801

156050	▶  400 x 160 mm	RASV0802
156040	◀ 	RASV0803
156060	◀ svetlo registar tablice	RASV0804
056710	▶ STAKLO 	RASV0805
056700	◀ STAKLO 	RASV0806



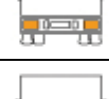

UNIVERZALNE STOP LAMPE

KBP	OPIS	RAPIDEX broj
40 256 012	▶   370 x 130 mm	RASV0141
40 256 011	◀ 	RASV0140
40 256 312	▶  	RASV0142
40 256 311	◀ 	RASV0143
40 256 112	▶ STAKLO 	RASV0136
40 256 111	◀ STAKLO 	RASV0137





40 275 012	▶   370 x 130 mm	RASV0807
40 275 011	◀ 	RASV0808
40 275 312	▶  	RASV0809
40 275 311	◀ 	RASV0810
40 275 112	▶ STAKLO 	RASV0133
40 275 111	◀ STAKLO 	RASV0132



2VP 340 942-011	▶  370 x 130 mm	RASV0811
2VP 340 942-001	◀ 	RASV0812
9EL 340 829-051	▶ STAKLO  ◀ STAKLO 	RASV0813



2VP 340 950-021	▶  403 x 145 mm	RASV0814
2VP 340 950-011	◀ 	RASV0815



RAZVODNE KUTIJE I RIKVERC ALARMI

Poz.	Slika	Naziv / Opis	RAPIDEX broj
1.		RAZVODNA KUTIJA MAN F90, F2000 OE broj 81.25435.0523	ELEK0256
2.		RAZVODNA KUTIJA 15 - lni → ISO 1185/ ISO 3731	ELEK0768
3.		RAZVODNA KUTIJA	ELEK0458
4.		RAZVODNA KUTIJA	ELEK0240
5.		RIKVERC ALARM 12/24 V, 97 dB	OSTA0370
6.		RIKVERC ALARM 12/24 V, 97 dB	OSTA0247

UNIVERZALNI GABARITI

KBP	OPIS	RAPIDEX broj
2XS 005 020-011	▶ 12/24V	RASV0450
	◀ T4W-Ba9s	



2XS 950 071-031 D10643	▶ 12/24V	RASV0281
	◀ T5W-Ba15S	



2XS 955 232-001 D10642	▶ 12/24V	RASV0280
	◀ T5W-Ba15S	



2XS 955 031-001	▶ 12/24V	RASV0277
	◀ T5W-Ba15S	

9EL 950 315-061	▶ STAKLO	RASV0816
-----------------	----------	----------

9EL 950 315-031	◀ STAKLO	RASV0817
-----------------	----------	----------

ASPOCK SUPERPOINT I

KBP	OPIS	RAPIDEX broj
35.588.000	▶ 12/24V	RASV0273
	◀ W5W-W2,1X9,5D	



35.590.000	▶ 12/24V	RASV0272
	◀ W5W-W2,1X9,5D	



35.592.000	▶ 12/24V	RASV0271
	◀ W5W-W2,1X9,5D	



35.812.000	▶ 12/24V	RASV0025
	◀ W5W-W2,1X9,5D	

ASPOCK SUPERPOINT II

KBP	OPIS	RAPIDEX broj
35.832.000	▶ 12/24V	RASV0068
35.833.000	◀ T4W-Ba9S	RASV0069
35.846.000	▶ 12/24V	RASV0070
35.847.000	◀ T4W-Ba9S	RASV0071
31 370 408	▶ 12/24V	RASV0818
	◀ T4W-Ba9S	
35.842.000	▶ 12/24V	RASV0819
35.843.000	◀ T4W-Ba9S	RASV0820

ASPOCK SUPERPOINT LED

KBP	OPIS	RAPIDEX broj
35.566.000	▶ LED	RASV0103
	◀	
35.568.000	▶ LED	RASV0821
	◀	
35.570.000	▶ LED	RASV0822
	◀	
35.820.000	▶ LED	RASV0823
	◀	
35.824.000	▶ LED	RASV0824
	◀	

ASPOCK PRO-SUPERPOINT III

KBP	OPIS	RAPIDEX broj
40 010 304	▶ LED	RASV0825
	◀	
40 011 304	▶ LED	RASV0826
	◀	
40 012 301	▶ LED	RASV0827
	◀	
40 013 304	▶ LED	RASV0828
	◀	

KRONE - EASYCON

KBP	OPIS	RAPIDEX broj
40 137 014	▶ 12/24V	RASV0139
40 137 004	◀ T4W-Ba9S	RASV0138

DAF 65, 75, 85, 65CF, 75CF, 85CF

OE broj	OPIS	RAPIDEX broj
703214431	▶  12/24V	RASV0412
	◀ C5W-SV8,5	

DAF LF, CF, XF

OE broj	OPIS	RAPIDEX broj
1329718	▶ 24V ◀ W5W-W2,1X9,5D	RASV0829

IVECO EUROCARGO, EUROSTAR, EUROTCH, STRALIS

OE broj	OPIS	RAPIDEX broj
98461649	▶ 24V	RASV0830
98464648	◀ T4W-Ba9S	RASV0831



OE broj	OPIS	RAPIDEX broj
500314717	▶ 24V	RASV0832
500314716	◀ T4W-Ba9S	RASV0833



OE broj	OPIS	RAPIDEX broj
41200664	▶ 24V ◀ W5W- W2,1X9,5D	RASV0102

IVECO STRALIS

OE broj	OPIS	RAPIDEX broj
504047264	▶ 24V	RASV0834
504047265	◀ T4W-Ba9S	RASV0835

MAN F90, F2000

OE broj	OPIS	RAPIDEX broj
81.25260.6015	▶ 24V ◀ 5W Ba 15s	RASV0034

MAN M2000, F2000 (1994 - ...)

OE broj	OPIS	RAPIDEX broj
81.25320.6082	▶ 24V ◀ 5W Ba 15s	RASV0173

MAN L2000, M2000, F2000, ME, LE, TGA

OE broj	OPIS	RAPIDEX broj
81.25260.6079	▶ 24V ◀ 5W W2,1X9,5D	RASV0260



OE broj	OPIS	RAPIDEX broj
81.25260.6104	▶ LED ◀	RASV0261



OE broj	OPIS	RAPIDEX broj
098221372	▶ LED ◀	RASV0262

MAN AUTOBUS

OE broj	OPIS	RAPIDEX broj
81.25260.6077	▶ 24V ◀ 3W W2,1X9,5D	RASV0836



OE broj	OPIS	RAPIDEX broj
81.25260.6095	▶ LED ◀	RASV0837

MERCEDES MK, NG, SK, ACTROS

OE broj	OPIS	RAPIDEX broj
140 000 18 33	▶ 12/24V	RASV0412
	◀ 5WSV8,5	

MERCEDES ATEGO I (1998 - 2004), ATEGO II (2004 - ...)

OE broj	OPIS	RAPIDEX broj
002 820 69 56	▶ 24V	RASV0838
002 820 68 56	◀ 10W Ba 15s	RASV0839

OE broj	OPIS	RAPIDEX broj
002 820 51 56	▶ 24V	RASV0840
002 820 50 56	◀ 10W Ba 15s	RASV0841

MERCEDES ACTROS, ATEGO

OE broj	OPIS	RAPIDEX broj
000 544 54 11	▶ 24V	RASV0842
	◀ W3W-W2,1X9,5D	

OE broj	OPIS	RAPIDEX broj
000 544 58 11	▶ LED	RASV0026
	◀	

RENAULT MAGNUM

OE broj	OPIS	RAPIDEX broj
5010217022	▶ 24V	RASV0843
	◀ T5W-Ba15s	

OE broj	OPIS	RAPIDEX broj
5010271807	▶ 24V	RASV0844
	◀ T5W-Ba15s	

RENAULT PREMIUM (1995 - 2005)

OE broj	OPIS	RAPIDEX broj
5001834561	▶ 24V	RASV0845
	◀ T5W-Ba15s	

RENAULT PREMIUM, MAGNUM

OE broj	OPIS	RAPIDEX broj
5010306792	▶ 24V	RASV0829
	◀ W5W-W2,1x9,5d	

OE broj	OPIS	RAPIDEX broj
5001862030	▶ 24V	RASV0846
	◀ W5W-W2,1x9,5d	

SCANIA SERIJA 4, P, R, T

OE broj	OPIS	RAPIDEX broj
1 326 935	▶ 24V	RASV0847
	◀ T5W-Ba15s	

SCANIA SERIJA 3, 4

OE broj	OPIS	RAPIDEX broj
1 379 371	▶ 24V ◀ W5W-W2,1X9,5D	RASV0848



OE broj	OPIS	RAPIDEX broj
1 471 599	▶ LED ◀	RASV0104

SCANIA SERIJA P, R, T

OE broj	OPIS	RAPIDEX broj
1 446 359	▶ LED ◀	RASV0849

VOLVO FL (2006 - ...)

OE broj	OPIS	RAPIDEX broj
20745225	▶ 24V ◀ T5W-Ba15s	RASV0850

VOLVO FH, FM

OE broj	OPIS	RAPIDEX broj
1623726	▶ 24V ◀ T5W-Ba15s	RASV0851

VOLVO FL, FM, FH

OE broj	OPIS	RAPIDEX broj
20734485	▶ 24V ◀ W5W-W2,1X9,5D	RASV0852



OE broj	OPIS	RAPIDEX broj
20398660	▶ LED ◀	RASV0024

VOLVO FH, FM (2008 - ...)

OE broj	OPIS	RAPIDEX broj
82116545	▶ LED ◀	RASV0916

UNIVERZALNI GABARITI

KBP	OPIS	RAPIDEX broj
38.418.000	▶ Ø140 mm ◀ LED 12/24V	RASV0917



84.054.300	▶ LED 12/24V ◀	RASV0918
------------	-------------------	----------



84.056.000	▶ LED 12/24V ◀	RASV0919
------------	-------------------	----------

UNIVERZALNI GABARITI

	KBP	OPIS	RAPIDEX broj
	2PS 340 000-001	▶ 92 x 66 mm 12/24V ◀ C5W-SV8,5	RASV0456
	2PF 006 717-011	▶ 110 x 40 mm 12/24V ◀ 5W-W2,1x9,5D	RASV0215
	2SA 006 717-001	▶ 110 x 40 mm 12/24V ◀ 5W-W2,1x9,5D	RASV0214
	2PS 006 717-031	▶ 110 x 40 mm 12/24V ◀ 5W-W2,1x9,5D	RASV0495
	2PS 006 717-061	▶ 110 x 40 mm 12/24V ◀ 5W-W2,1x9,5D	RASV0531
	194130	▶ 110 x 55 x 34 mm 12/24V ◀ T4W-BA9s	RASV0293
	194250	▶ 110 x 55 x 34 mm 12/24V ◀ T4W-BA9s	RASV0307
	194010	▶ 110 x 55 x 34 mm 12/24V ◀ T4W-BA9s	RASV0294
	001586	▶ ◀	RASV0304

UNIVERZALNI GABARITI

	KBP	OPIS	RAPIDEX broj
	T7540.01	▶ 12/24V ◀ C5W-SV8,5	RASV0441
	2PG 003 057-011	▶ 62 x 62 x 46 mm 12/24V ◀ C5W-SV8,5	RASV0411
	2SA 003 057-021	▶ 62 x 62 x 46 mm 12/24V ◀ C5W-SV8,5	RASV0200
	01.090.7540.05	▶ 114 x 23 x 54 mm ◀ LED	RASV0400
	01.090.7540.06	▶ 114 x 23 x 54 mm ◀ LED	RASV0383
	31 770 401	▶ 119 x 44 mm ◀ LED	RASV0266
	31 780 401	▶ 119 x 44 mm ◀ LED	RASV0267
	31 206 401	▶ 119 x 44 mm ◀ LED	RASV0471

UNIVERZALNI GABARITI

	KBP	OPIS	RAPIDEX broj
	35.712.120 40 015 513	▶ 96 x 31 mm LED ◀ 40 015 513 sa kablom	RASV0270
	35.734.124 40 015 502	▶ 96 x 31 mm LED ◀ 40 015 502 sa kablom	RASV0268
	35.726.000 40 015 521	▶ 96 x 31 mm LED ◀ 40 015 521 sa kablom	RASV0269
	40 023 003 2PG 008 645-041	▶ 130 x 32 mm LED ◀	RASV0853
	40 023 002	▶ 130 x 32 mm LED ◀	RASV0854
	40 023 001 2PS 008 645-001	▶ 130 x 32 mm LED ◀	RASV0855
	40 024 011 2PS 008 643-021	▶ 130 x 32 mm LED ◀	RASV0856
	31 690 401	▶ 110 x 84 mm LED ◀	RASV0857
	31 640 401	▶ 110 x 84 mm LED ◀	RASV0858
	31 236 408	▶ 110 x 84 mm LED ◀	RASV0859

SVETLA REGISTAR TABLICE

	KBP	OPIS	RAPIDEX broj
	2KA 003 389-061	▶ 12/24V R10W-Ba15s ◀	RASV0396
	39.262.000. 40 182 004	▶ 12/24V C5W-SV8,5 ◀	RASV0075
	39.260.000 36 300 403	▶ 12/24V C5W-SV8,5 ◀	RASV0105
	39.280.000	▶ LED ◀	RASV0860

KATADIOPTERI

	KBP	OPIS	RAPIDEX broj	
	8RA 002 014-041	BELI	Ø 60 mm RASV0861	
	8RA 002 014-051	ŽUTI		RASV0459
	8RA 002 014-031	CRVENI		RASV0460
	8RA 003 326-021	BELI	94 x 44 mm RASV0458	
	8RA 003 326-011	ŽUTI		RASV0457
	8RA 003 326-001	CRVENI		RASV0410
	01.090.7520.05		RASV0222	

KL 7000 F

KBP	OPIS	RAPIDEX broj
2RL 008 061-101	12V	 H1 RASV0862
2RL 008 061-111	24V	
9EL 862 141-001	ŽUTO STAKLO	RASV0864
9EL 862 140-001	PLAVO STAKLO	RASV0865

KL 7000 M

KBP	OPIS	RAPIDEX broj
2RL 008 062-101	12/24V	 H1 RASV0866
2RL 008 062-111	24/12V	
9EL 862 141-001	ŽUTO STAKLO	RASV0864
9EL 862 140-001	PLAVO STAKLO	RASV0865

KL 7000 M

KBP	OPIS	RAPIDEX broj
2RL 008 062-001	12/24V	 H1 RASV0868
2RL 008 062-011	24/12V	
9EL 862 141-001	ŽUTO STAKLO	RASV0864
9EL 862 140-001	PLAVO STAKLO	RASV0865

KL 7000 R

KBP	OPIS	RAPIDEX broj
2RL 008 060-101	12/24V	 H1 RASV0870
2RL 008 060-111	24/12V	
9EL 862 141-001	ŽUTO STAKLO	RASV0864
9EL 862 140-001	PLAVO STAKLO	RASV0865

JUNIOR PLUS F

KBP	OPIS	RAPIDEX broj
2RL 008 965-001	12V	 H1 RASV0467
2RL 008 965-011	24V	
9EL 863 100-001	ŽUTO STAKLO	RASV0873

JUNIOR F

KBP	OPIS	RAPIDEX broj
2RL 007 550-001	12V	 H1 RASV0533
2RL 007 550-011	24V	
9EL 860 627-001	ŽUTO STAKLO	RASV0505
9EL 860 628-021	PLAVO STAKLO	RASV0874

JUNIOR M

KBP	OPIS		RAPIDEX broj
2RL 007 552-001	12V		RASV0560
2RL 007 552-011	24V		RASV0559
9EL 860 627-001	ŽUTO STAKLO		RASV0505
9EL 860 628-021	PLAVO STAKLO		RASV0874

JUNIOR R

KBP	OPIS		RAPIDEX broj
2RL 007 551-001	12V		RASV0055
2RL 007 551-011	24V		RASV0053
9EL 860 627-001	ŽUTO STAKLO		RASV0505
9EL 860 628-021	PLAVO STAKLO		RASV0874

UNIVERZALNA ROTACIONA LAMPA

KBP	OPIS		RAPIDEX broj
78.122.000	12/24V		RASV0875

UNIVERZALNA ROTACIONA LAMPA

KBP	OPIS		RAPIDEX broj
78.120.000	12/24V		RASV0876

UNIVERZALNA ROTACIONA LAMPA

KBP	OPIS		RAPIDEX broj
76.870.000	12/24V		RASV0278
76.870.022	STAKLO		RASV0265

UNIVERZALNA ROTACIONA LAMPA

KBP	OPIS		RAPIDEX broj
76.872.000	12/24V		RASV0264
76.870.022	STAKLO		RASV0265

UNIVERZALNA ROTACIONA LAMPA

KBP	OPIS		RAPIDEX broj
76.874.000	12/24V		RASV0488
76.870.022	STAKLO		RASV0265

H1 - P14,5s

OPIS	RAPIDEX broj
12V H1-55W	RASV0561
24V H1-70W	RASV0534

H2 - H511

OPIS	RAPIDEX broj
12V H2-55W	RASV0880
24V H2-70W	RASV0881

H3 - PK22s

OPIS	RAPIDEX broj
12V H3-55W	RASV0536
24V H3-70W	RASV0570

H4 - P43t

OPIS	RAPIDEX broj
12V H4-60/55W	RASV0576
24V H4-75/70W	RASV0572

H7 - Px26d

OPIS	RAPIDEX broj
12V H7-55W	RASV0565
24V H7-70W	RASV0524

H8 - PGJ19-1

OPIS	RAPIDEX broj
12V H8-35W	RASV0882

H9 - PGJ19-5

OPIS	RAPIDEX broj
12V H9-55W	RASV0877

H10 - PY20d

OPIS	RAPIDEX broj
12V H10-42W	RASV0883

H11 - PGJ19-2

OPIS	RAPIDEX broj
12V H11-55W	RASV0878
24V H11-70W	RASV0879

H21W - BAY9s

OPIS	RAPIDEX broj
12V H21W	RASV0884
24V H21W	RASV0096

D2R - P32d3

OPIS	RAPIDEX broj
D2R-35W	RASV0885

D2S - P32d2

OPIS	RAPIDEX broj
D2S-35W	RASV0886

R2 - P45t

OPIS	RAPIDEX broj
12V R2-45/40W	RASV0550
24V R2-55/50W	RASV0571

P21W - BA15s

OPIS	RAPIDEX broj
12V P21W	RASV0573
24V P21W	RASV0575

PY21W - BAU15s

OPIS	RAPIDEX broj
12V PY21W	RASV0562
24V PY21W	RASV0499

P21/5W - BAY15d

OPIS	RAPIDEX broj
12V P21/5W	RASV0535
24V P21/5W	RASV0549

R5W - BA15s

OPIS	RAPIDEX broj
12V R5W	RASV0574
24V R5W	RASV0566

R10W - BA15s

OPIS	RAPIDEX broj
12V R10W	RASV0490
24V R10W	RASV0514

C5W - SV8,5

OPIS	RAPIDEX broj
12V C5W	RASV0887
24V C5W	RASV0532

C10W - SV8,5

OPIS	RAPIDEX broj
12V C10W	RASV0888
24V C10W	RASV0315

T3W - BA9s

OPIS	RAPIDEX broj
12V T3W	RASV0502
24V T3W	RASV0501

T4W - BA9s

OPIS	RAPIDEX broj
12V T4W	RASV0889
24V T4W	RASV0890

W3W - W2,1x9,5d

OPIS	RAPIDEX broj
12V W3W	RASV0564
24V W3W	RASV0569

W5W - W2,1x9,5d

OPIS	RAPIDEX broj
12V W5W	RASV0484
24V W5W	RASV0500

W1,2W - W2x4,6d

OPIS	RAPIDEX broj
12V W1,2W	RASV0563
24V W1,2W	RASV0543

W1,2W - B8,3d

OPIS	RAPIDEX broj
12V W1,2W	RASV0893
24V W1,2W	RASV0544

GARNITURA SIJALICA H7

OPIS	RAPIDEX broj
12V H7	RASV0153
24V H7	RASV0213

GARNITURA SIJALICA H4

OPIS	RAPIDEX broj
12V H4	RASV0540
24V H4	RASV0203

GARNITURA SIJALICA H7

OPIS	RAPIDEX broj
2 x 24V H7	RASV0892

GARNITURA SIJALICA H4

OPIS	RAPIDEX broj
2 x 24V H4	RASV0895

OSIGURAČI UBODNI

Slika	Poz.	Opis	KBP	RAPIDEX broj
	1.	5A OKER	8JS 711 684-002	ELEK0684
	2.	7,5A BRAON	8JS 711 685-002	ELEK0258
	3.	10A CRVENI	8JS 711 686-002	RASV0568
	4.	15A PLAVI	8JS 711 687-002	RASV0567
	5.	20A ŽUTI	8JS 711 688-002	ELEK0257
	6.	25A BELI	8JS 711 689-002	ELEK0575
	7.	30A ZELENI	8JS 711 690-002	RASV0539
	8.	40A NARANDŽASTI	8JS 711 683-031	ELEK0769

OSIGURAČI UBODNI - MINI

Slika	Poz.	Opis	KBP	RAPIDEX broj
	1.	5A	8JS 728 596-131	RASV0183
	2.	7,5A	8JS 728 596-111	RASV0184
	3.	10A	8JS 728 596-141	RASV0185
	4.	15A	8JS 728 596-151	RASV0186
	5.	20A	8JS 728 596-161	RASV0187
	6.	25A	8JS 728 596-091	RASV0188
	7.	30A	8JS 728 596-171	RASV0189

OSIGURAČI UBODNI - MAXI

Slika	Poz.	Opis	KBP	RAPIDEX broj
	1.	20A	8JS 728 595-051	RASV0920
	2.	30A	8JS 728 595-141	RASV0921
	3.	40A	8JS 728 595-151	RASV0922
	4.	50A	8JS 728 595-161	RASV0923
	5.	60A	8JS 728 595-171	RASV0924
	6.	70A	8JS 728 595-101	RASV0925
	7.	80A	8JS 728 595-111	RASV0927

OSIGURAČI - MIDI

Slika	Poz.	Opis	KBP	RAPIDEX broj
	1.	30A	8JS 742 901-061	RASV0928
	2.	50A	8JS 742 901-011	RASV0929
	3.	150A	8JS 742 901-081	RASV0052

OSIGURAČI - MEGA

Slika	Poz.	Opis	KBP	RAPIDEX broj
	1.	125A	8JS 742 902-011	RASV0930
	2.	150A	8JS 742 902-021	RASV0931
	3.	200A	8JS 742 902-041	RASV0932
	4.	250A	8JS 742 902-051	RASV0933
	5.	300A	8JS 742 902-071	RASV0934

OSIGURAČI - KERAMIČKI

Slika	Poz.	Opis	KBP	RAPIDEX broj
	1.	8A BELI	8JS 025 889-003	ELEK0290
	2.	16A CRVENI	8JS 089 015-003	ELEK0259
	3.	25A PLAVI	8JS 091 603-003	ELEK0567
	4.	40A OKER	8JS 713 144-003	ELEK0129

OSIGURAČI

Slika	Poz.	Opis	KBP	RAPIDEX broj
	1.	50A	8JS 713 575-021	ELEK0574
	2.	80A	8JS 713 575-001	ELEK0660

TAHOGRAF LISTIĆI

Slika	Poz.	Opis	RAPIDEX broj
	1.	125-24 EC4K	OPRE0224
	2.	125-1-7	OPRE0222
	3.	125-7X24	OPRE0221
	4.	100-7X24	OPRE0204
	5.	100-24 EC4K	OPRE0210
	6.	100-1/7-24	OPRE0189
	7.	140-24 EC4K	OPRE0216
	8.	180-24 EC4B	OPRE0203
	9.	100-3300-24 EC4K	OPRE0220
	10.	125-3300-24 EC4KA	OPRE0122
	11.	SERTIFIKAT-VIKEND	OPRE0105





SPIRALNI KABLOVI

Slika	Poz.	Opis	KBP	RAPIDEX broj
	1.	7 - ŽILNI	611 110	ELEK0609
	2.	ISO 1724 7 - lni	8KA 004 797-021	ELEK0770
	3.	ISO 1185 7 - lni	8KA 004 797-041	ELEK0287
	4.	ISO 3731 7 - lni	8KA 004 797-051	ELEK0370
	5.	ISO 7638 ABS/EBS	8KA 004 648-021	ELEK0216
	6.	ISO 12098 15 - lni	8KA 004 648-041	ELEK0671
	7.	15/2 x 7 - lni	8JA 005 952-041	ELEK0450







ADAPTER

Slika	Poz.	Opis	KBP	RAPIDEX broj
	1.	15/2 x 7 - lin	8JA 005 952-061	ELEK0247

UTIKAČI

Slika	Poz.	Opis	KBP	RAPIDEX broj
	1.	ISO 1724 7 - lni 12V	8JA 001 930-003	ELEK0607
	2.	ISO 1185 7 - lni	8JA 008 831-001	RASV0541
	3.	ISO 3731 7 - lni	8JA 008 832-011	ELEK0491
	4.	ISO 7638 ABS/EBS	8JB 007 645-031	ELEK0470
	5.	ISO 12098 15 - lni	8JA 007 241-031	ELEK0250

UTIČNICE				
Slika	Poz.	Opis	KBP	RAPIDEX broj
	1.	ISO 1724 7 - Ini 12V	8JB 001 943-003	ELEK0606
	2.	ISO 1185 7 - Ini	8JB 003 833-001	RASV0513
	3.	ISO 3731 7 - Ini	8JB 003 834-001	RASV0452
	4.	ISO 7638 ABS/EBS	8JB 007 645-031	ELEK0402
	5.	ISO 12098 15 - Ini	8JB 007 242-011	ELEK0249

KOMBINOVANI PREKIDAČI POD VOLANOM				
Poz.	Slika	Tip vozila	OE broj	RAPIDEX broj
1.		DAF F1800, F1900, F2100, F2300, F2500, F2800, F3300, F3600	06416275	ELEK0783
2.		DAF 95XF	1615081	ELEK0784
3.		DAF 95	1615082, 1440216, 1390126	ELEK0785
4.		IVECO EURO TECH 400E34	93191486	ELEK0786
5.		IVECO EURO TECH 400E34	93191487	ELEK0787
6.		IVECO EURO STAR, EURO TRAKKER	93191488	ELEK0788

KOMBINOVANI PREKIDAČI POD VOLANOM				
Poz.	Slika	Tip vozila	OE broj	RAPIDEX broj
7.		MAN F90, F2000	81.25509.0020	ELEK0003
8.		MAN SG, SL, SU	81.25509.0018	ELEK0789
9.		MAN F90, L2000, M2000, TGA, M90, NM, UL	81.25509.0093	ELEK0002
10.		MAN TGA, TGL, TGM, TGS, TGX	81.25509.0123	ELEK0004
11.		MERCEDES LK/LN	003 545 83 24	ELEK0790
12.		MERCEDES LK/LN, T2/LN1	673 540 04 45	ELEK0791

KOMBINOVANI PREKIDAČI POD VOLANOM				
Poz.	Slika	Tip vozila	OE broj	RAPIDEX broj
13.		MERCEDES NG, SK, O404	620 540 00 45	ELEK0666
14.		MERCEDES NG, SK, O404	343 540 00 45	ELEK0792
15.		MERCEDES SK, MK	655 540 00 45	ELEK0254
16.		MERCEDES ACTROS, ATEGO, AXOR	008 545 01 24	ELEK0001
17.		MERCEDES CITARO, NEOPLAN, EVOBUS	002 540 62 44	ELEK0108
18.		MERCEDES O405, O407, O408	357 540 00 45	ELEK0793

KOMBINOVANI PREKIDAČI POD VOLANOM				
Poz.	Slika	Tip vozila	OE broj	RAPIDEX broj
19.		MERCEDES O405, O407, O408	357 540 95 45	ELEK0007
20.		MERCEDES UNIMOG	004 545 81 24	ELEK0794
21.		MERCEDES NG, O303, O404	005 545 51 24	ELEK0658
22.		MERCEDES LP	034 181 00 09	ELEK0795
23.		MERCEDES UNIMOG	003 545 87 24	ELEK0796
24.		MERCEDES T1, T1-BUS	005 545 74 24	ELEK0797

KOMBINOVANI PREKIDAČI POD VOLANOM				
Poz.	Slika	Tip vozila	OE broj	RAPIDEX broj
25.		MERCEDES LK/LN2	003 545 83 24	ELEK0790
26.		NEOPLAN N116, N122	150608600	ELEK0005
27.		RENAULT PREMIUM	5001837500	ELEK0798
28.		SCANIA 94, 114, 124, 144	1 402 449	ELEK0799
29.		SCANIA 113, 143	360248	ELEK0008
30.		SCANIA 113, 143	360247	ELEK0800

KOMBINOVANI PREKIDAČI POD VOLANOM				
Poz.	Slika	Tip vozila	OE broj	RAPIDEX broj
31.		SCANIA 113, 143	1 424 970	ELEK0801
32.		SCANIA 112	330982	ELEK0802
33.		SCANIA 94, 114, 124, 144	1 373 190	ELEK0006
34.		SCANIA 114, 124, 144	1 4024 48	ELEK0285
35.		SCANIA 113	201725	ELEK0803
36.		SCANIA 93, 113, 143	1 358 175	ELEK0804

KOMBINOVANI PREKIDAČI POD VOLANOM				
Poz.	Slika	Tip vozila	OE broj	RAPIDEX broj
37.		SETRA	733 201 70 00	ELEK0372
38.		VOLVO FH12, FH16	3944672	ELEK0805
39.		VOLVO FH12, FH16	3172171	ELEK0009
40.		VOLVO F12	8155750	ELEK0010
41.		VOLVO FL7, FL10	8157723	ELEK0806
42.		VOLVO FH12	3944025	ELEK0807

KOMBINOVANI PREKIDAČI POD VOLANOM				
Poz.	Slika	Tip vozila	OE broj	RAPIDEX broj
43.		VOLVO FH12	20424046	ELEK0808
44.		VOLVO FL10	8158723	ELEK0809
45.		VOLVO F7, F10, F12, F16	1594959	ELEK0810
46.		VOLVO FH, FM	3172171	ELEK0811
47.		VOLVO FL6, FL7, FL10, FL12	1579255	ELEK0812
48.		VOLVO FL6, FL7, FL10, FL12	8154792	ELEK0813

KOMBINOVANI PREKIDAČI POD VOLANOM				
Poz.	Slika	Tip vozila	OE broj	RAPIDEX broj
49.		VOLVO FL7, FL10	8158724	ELEK0814
50.		VOLVO FH12, FH16	3172170	ELEK0815
51.		VOLVO FH12, FH16	1624133	ELEK0497

VARTA

BY JOHNSON CONTROLS

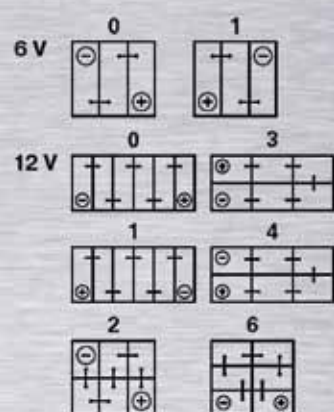
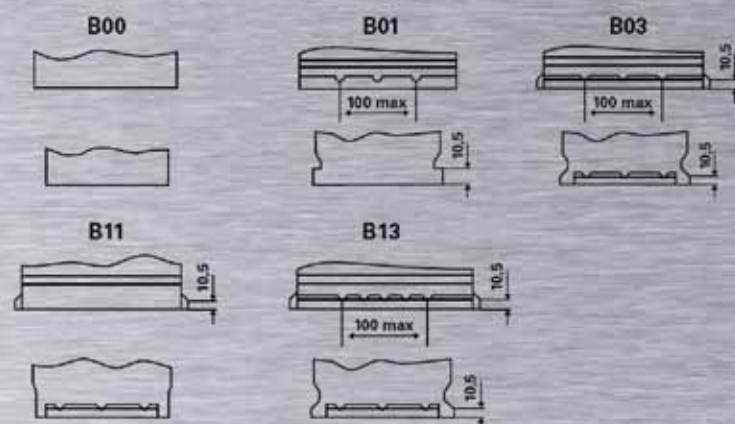

VARTA broj	Skraćenica	Volt	Ah	Dužina (mm)	Širina (mm)	Visina (mm)	A	Spoj	Polovi	Podna prirubnica	RAPIDEX broj
610 013 076 310 0	12w	12	110	514	175	210	760	3	1	B03	OPRE0248
625 014 072 310 0	J2w	12	125	345	172	290	720	1	1	B00	OPRE0246
640 400 080 341 2	K8	12	140	513	189	223	800	3	1	B03	OPRE0249
643 033 095 310 0	K4w	12	143	514	218	210	950	3	1	B03	OPRE0250
670 103 100 341 2	M8	12	170	513	223	223	1000	3	1	B00	OPRE0233
680 108 100 341 2	M18	12	180	513	223	223	1000	3	1	B00	OPRE0251
725 103 115 341 2	N9	12	215	518	276	242	1150	3	1	B00	OPRE0234

TEHNIČKO OBJAŠNJENJE:
Položaji polova

Podna prirubnica

PRIBORI

Slika	Opis	RAPIDEX broj
	Kablovi za startovanje 25 mm ² x 3,5 m	ELEK0554
	Kablovi za startovanje 35 mm ² x 4,5 m	ELEK0703
	Kablovi za startovanje 50 mm ² x 7 m	ELEK0704
	Kontakt klešta 25 - 50 mm ²	ELEK0705
	Klemna +	ELEK0640
	Klemna -	ELEK0600
	Merač kiseline	ELEK0706

ProAtomic akumulatori

Snaga atoma.



- Optimalno prilagođena snaga za starija i novija vozila.
- Bez dodatnog održavanja.
- Izuzetno prihvatljiva cena.
- Paleta putničkih i teretnih akumulatora.
- 30 meseci garancije.

ProAtomic
BY JOHNSON CONTROLS

AKUMULATORI

Oznaka ETN	Skraćenica	Kapacitet	Struja pri hladnom stanju	Dužina (mm)	Širina (mm)	Visina (mm)	Sistem vezivanja	Priključni polovi	Podna prirubnica	RAPIDEX broj
535119030	L35	35	300	187	127	227	1	3	B00	OPRE0252
540406034	D40	40	340	175	175	190	0	1	B13	OPRE0253
545412040	D45	45	400	207	175	190	0	1	B13	OPRE0254
545413040	L45	45	400	207	175	190	1	1	B13	OPRE0091
556400048	D56	56	480	242	175	190	0	1	B13	OPRE0255
556401048	L56	56	480	242	175	190	1	1	B13	OPRE0237
560408054	D60	60	540	242	175	190	0	1	B13	OPRE0256
560127054	L60	60	540	242	175	190	1	1	B13	OPRE0257
574012068	D74	74	680	278	175	190	0	1	B13	OPRE0258
583400072	D83	83	720	353	175	175	0	1	B13	OPRE0259
595402080	D95	95	800	353	175	190	0	1	B01	OPRE0201
610013076	L110	110	760	514	175	210	3	1	B00	OPRE0159
640135076	L140	140	950	513	189	223	3	1	B00	OPRE0187
670043100	L170	170	1000	513	223	223	3	1	B00	OPRE0156
720025145	L220	225	1450	518	291	242	3	1	B01	OPRE0235

Sistem vezivanja

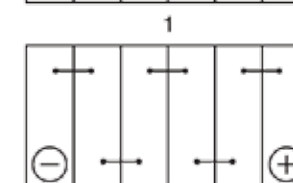
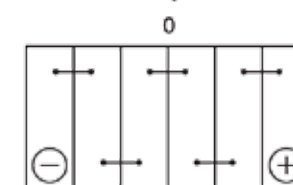

Priključni polovi

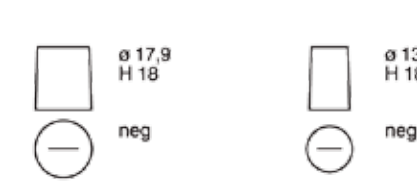
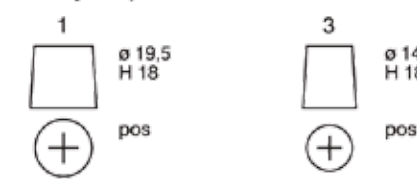

Podna prirubnica

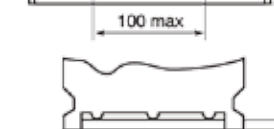
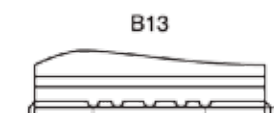
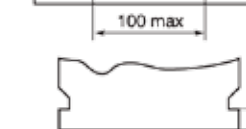
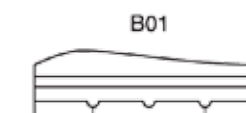
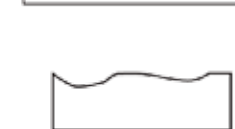
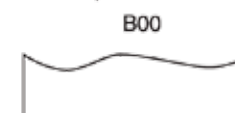

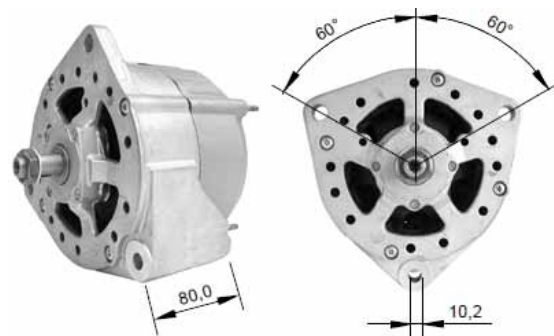
28V 55A

Tip vozila	KBP	OE broj	RAPIDEX broj
DAF, MAN L2000, M2000, M90, F90, F2000, MERCEDES MK, NG, SK	0 120 469 686	1274480 51.26101.7185 005 154 34 02	ELEK0707

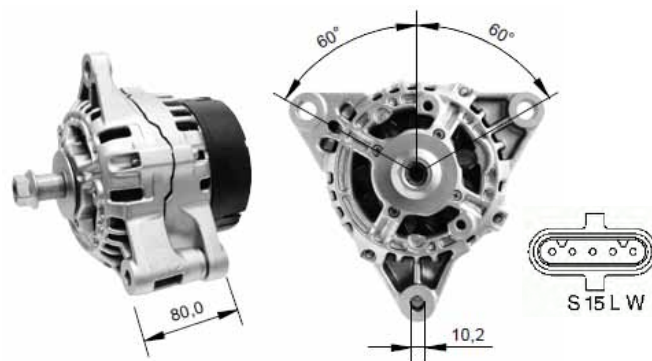

Tip vozila	KBP	OE broj	RAPIDEX broj
MAN L2000, M2000, F2000, TGA	0 123 325 500	51.26101.7231	ELEK0708

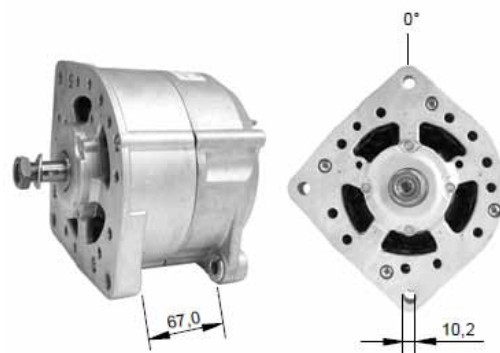
28V 65A

Tip vozila	KBP	OE broj	RAPIDEX broj
SCANIA SEIJA 3, 4	0 120 468 131	1 394 969	ELEK0709

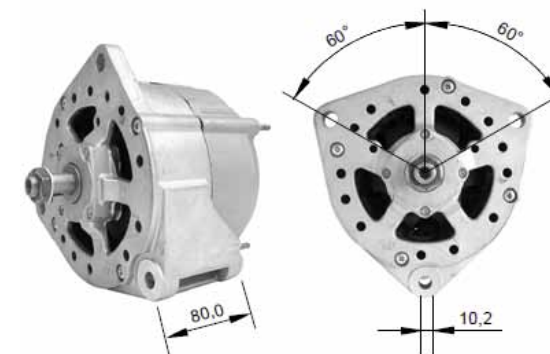
28V 80A

Tip vozila	KBP	OE broj	RAPIDEX broj
DAF, MAN L2000, M2000, M90, F90, F2000, MERCEDES MK, NG, SK	0 120 468 107	091295 51.26101.7192 007 154 92 02	ELEK0710

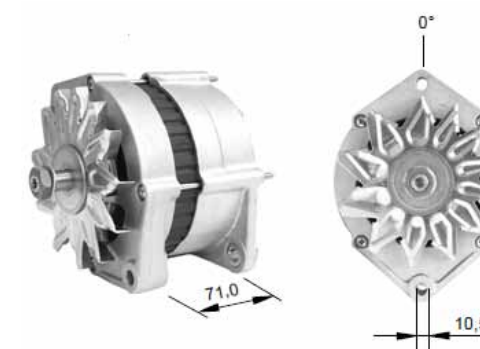

Tip vozila	KBP	OE broj	RAPIDEX broj
IVECO EUROCARGO, EUROSTAR, EUROTECH, EUROTRAKKER	0 120 468 124	98424453	ELEK0711

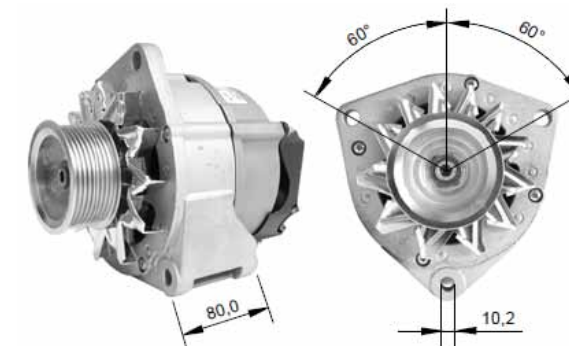

Tip vozila / Opis	KBP	OE broj	RAPIDEX broj
MERCEDES ACTROS PK9 Ø77 mm	0 120 469 116	009 154 97 02	ELEK0279
MERCEDES ATEGO PK8 Ø72 mm	0 120 469 115	009 154 98 02	ELEK0712

28V 80A

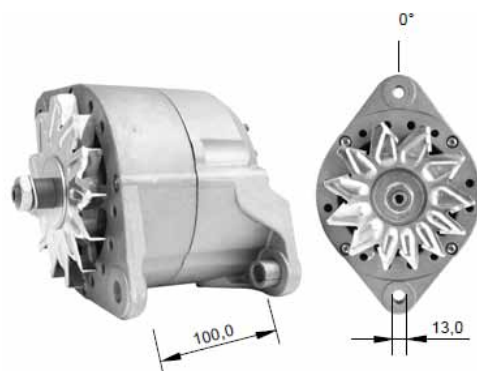

Tip vozila	KBP	OE broj	RAPIDEX broj
VOLVO FL, FH12, FH16	0 120 468 135	8156817	ELEK0713

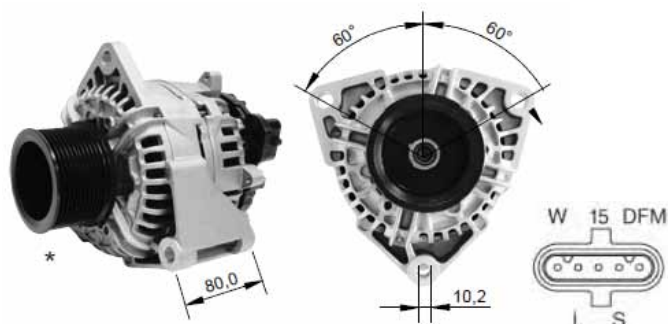

Tip vozila / Opis	KBP	OE broj	RAPIDEX broj
MERCEDES ACTROS PK9 Ø77 mm	0 124 555 001	011 154 86 02	ELEK0251
MERCEDES ACTROS PK11 Ø77 mm	0 124 555 004	012 154 04 02	ELEK0714
MERCEDES ATEGO PK8 Ø72 mm	0 124 555 002	012 154 10 02	ELEK0715

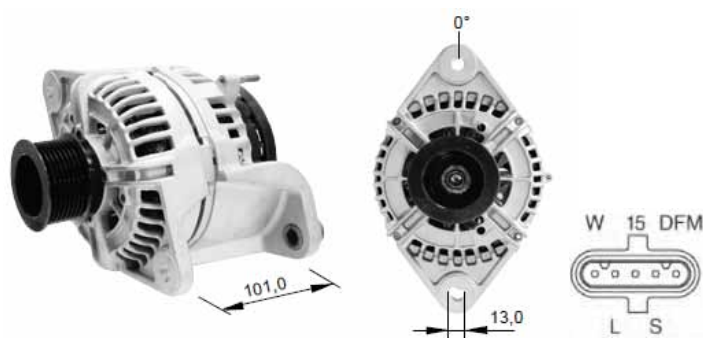

Tip vozila / Opis	KBP	OE broj	RAPIDEX broj
VOLVO FM12, FH12 PK8 Ø63 mm	0 124 555 009	20409228	ELEK0716

28V 90A



Tip vozila / Opis	KBP	OE broj	RAPIDEX broj
IVECO EUROTECH, EUROTRAKKER, STRALIS PK10 Ø62 mm	0 123 525 500	500331736	ELEK0722

28V 100A

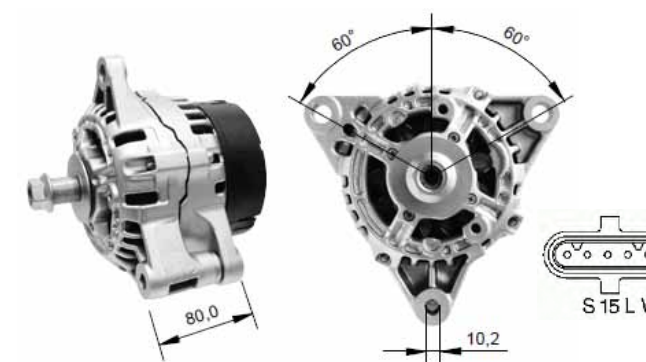

Tip vozila / Opis	KBP	OE broj	RAPIDEX broj
MAN L2000, M2000, F2000, TGA	0 123 525 501	51.26101.7232	ELEK0717

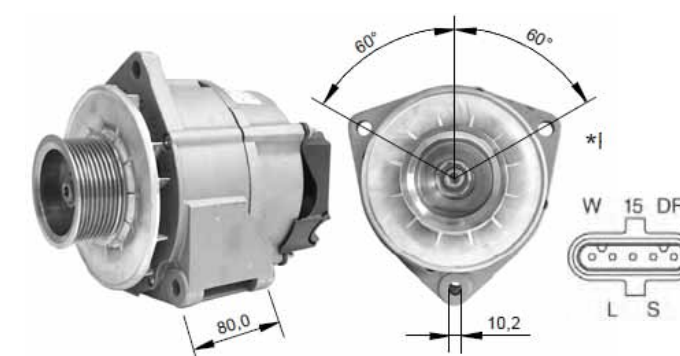

Tip vozila / Opis	KBP	OE broj	RAPIDEX broj
MERCEDES ACTROS PK9 Ø77 mm	0 120 468 143	009 154 99 02	ELEK0718

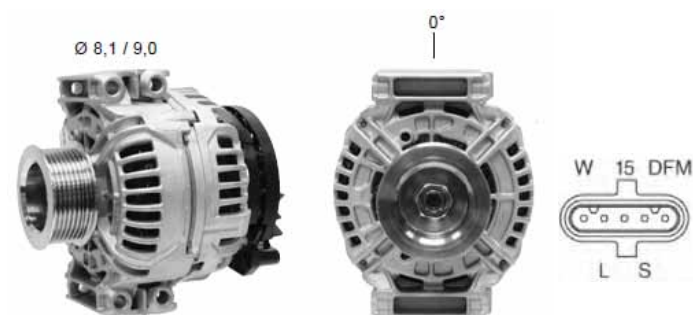
28V 100A

Tip vozila / Opis	KBP	OE broj	RAPIDEX broj
SCANIA P, G, R, T PK8 Ø72 mm	0 124 655 007	1 475 569	ELEK0719

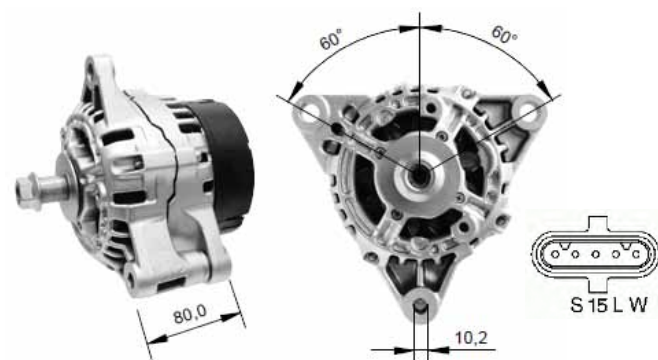
28V 110A

Tip vozila / Opis	KBP	OE broj	RAPIDEX broj
MAN TGL, TGM, TGA	0 124 655 009	51.26101.7246	ELEK0720

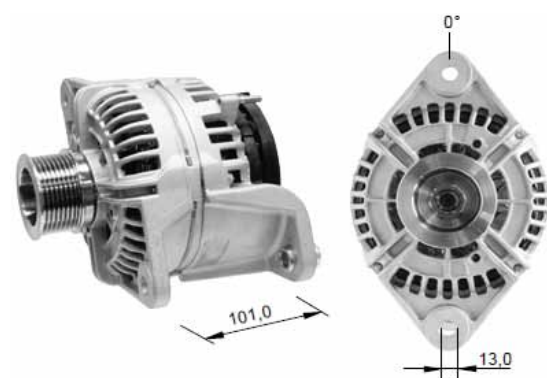

Tip vozila / Opis	KBP	OE broj	RAPIDEX broj
VOLVO FH12 PK8 Ø63 mm	0 124 655 008	20849351	ELEK0721

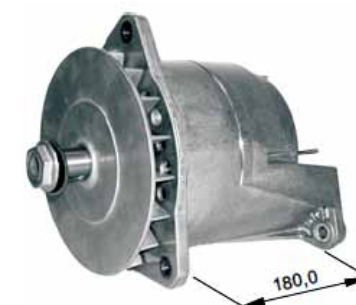
28V 120-140A

Tip vozila / Opis	KBP	OE broj	RAPIDEX broj
AUTOBUSI MAN, MERCEDES	0 120 689 520	007 154 28 02	ELEK0507

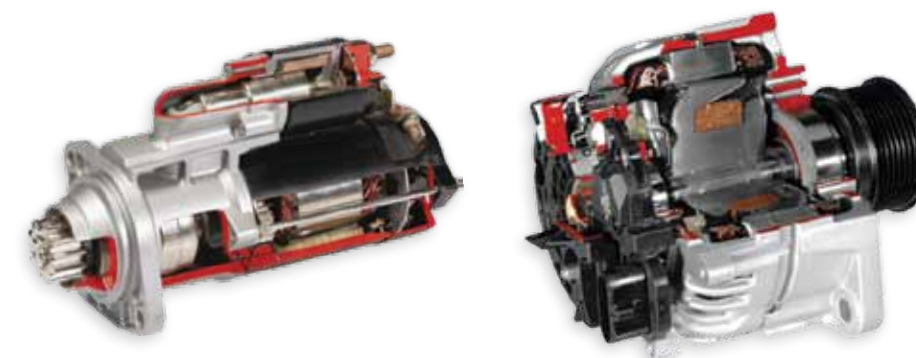

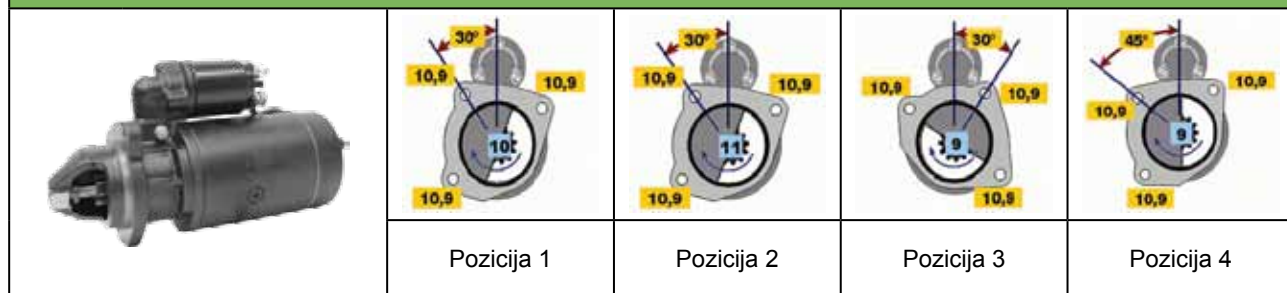
24V 4kW

Pozicija	Tip vozila	KBP	OE broj	RAPIDEX broj
1.	MAN L2000, M90, M2000	0 001 368 081	51.26201.7140	ELEK0723
2.	MAN L2000, M90, M2000	0 001 368 310	51.26201.7143	ELEK0724
3.	MERCEDES LK, MK, NG	0 001 368 309	004 151 59 01	ELEK0544
4.	SCANIA SERIJA 2, 3, 4	0 001 368 010	571450	ELEK0725

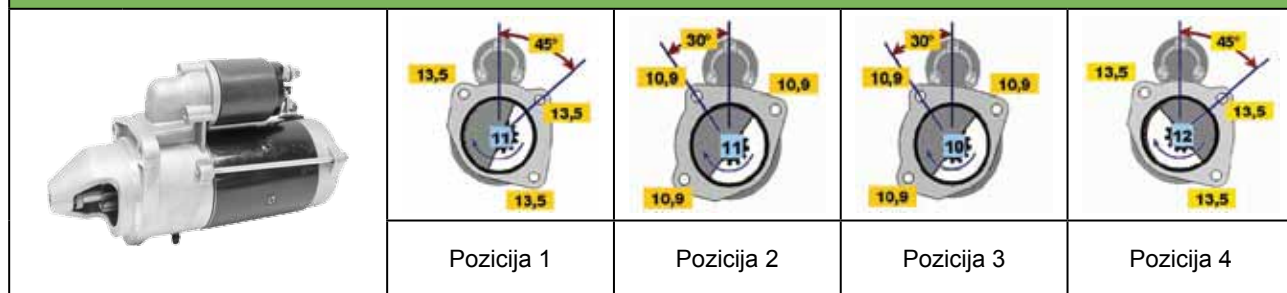
24V 4kW

Pozicija	Tip vozila	KBP	OE broj	RAPIDEX broj
1.	DAF 75CF, CF75	0 001 231 013	1346162	ELEK0726
2.	MAN L2000, M90, M2000	0 001 231 007	51.26201.7157	ELEK0727
3.	MAN L2000, M90, M2000	0 001 231 008	51.26201.7158	ELEK0728
4.	VOLVO FM	0 001 231 004	3978710	ELEK0729

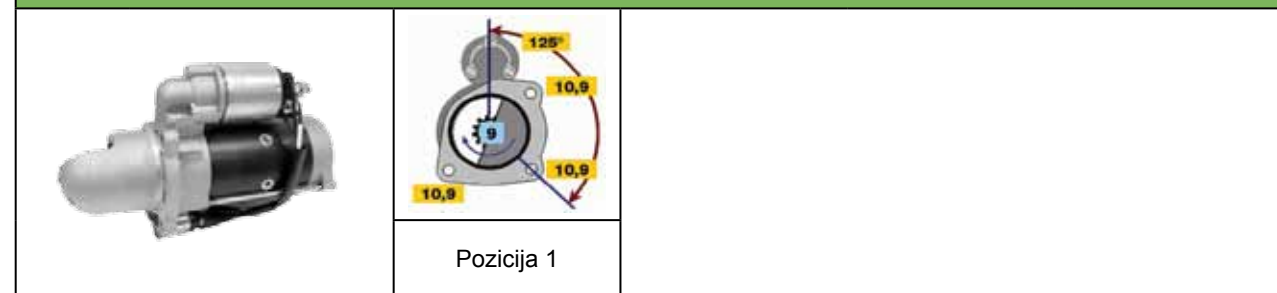
24V 4kW

Pozicija	Tip vozila	KBP	OE broj	RAPIDEX broj
1.	MERCEDES VARIO, ATEGO, AXOR	0 001 231 002	004 151 84 01	ELEK0730

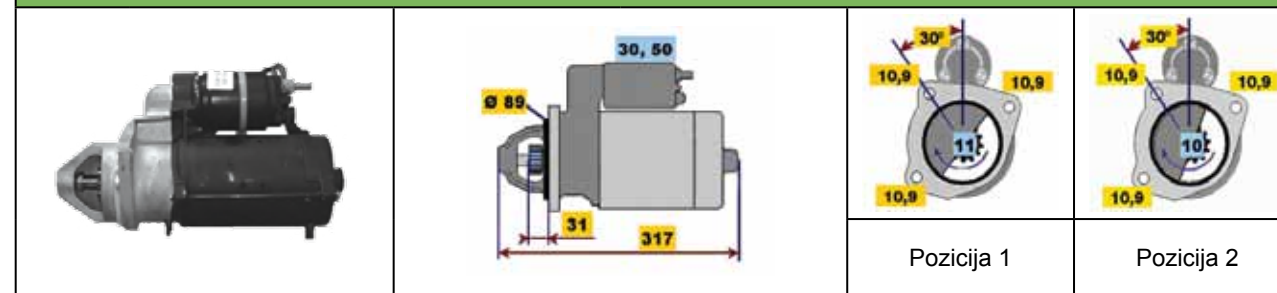
24V 4kW

Pozicija	Tip vozila	KBP	OE broj	RAPIDEX broj
1.	MAN TGL, TGM	0 001 231 023	51.26201.7222	ELEK0731
2.	MAN TGL, TGM	0 001 231 035	51.26201.7223	ELEK0732

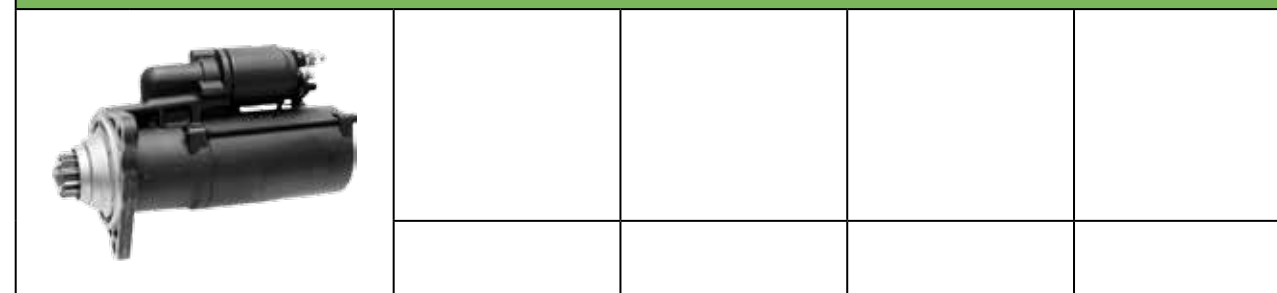
24V 5,5kW

Pozicija	Tip vozila	KBP	OE broj	RAPIDEX broj
1.	DAF CF, XF	0 001 241 003	1688720	ELEK0733

24V 5,5kW

				
Pozicija	Tip vozila	KBP	OE broj	RAPIDEX broj
1.	IVECO EUROSTAR, EUROTECH, STRALIS	M009T61671	99486046	ELEK0771





24V 5,5kW

				
Pozicija	Tip vozila	KBP	OE broj	RAPIDEX broj
1.	MAN TGA D2066, D2676	M009T61971	51.26201.7199	ELEK0772



24V 5,5kW

				
Pozicija	Tip vozila	KBP	OE broj	RAPIDEX broj
1.	SCANIA P, G, R, T	0 001 241 001	1 447 911	ELEK0773

24V 6,2kW

					
					
		Pozicija 1	Pozicija 2	Pozicija 3	Pozicija 4
Pozicija	Tip vozila	KBP	OE broj	RAPIDEX broj	
1.	DAF XF	0 001 372 007	1357210	ELEK0774	
2.	MERCEDES ACTROS	0 001 372 001	004 151 94 01	ELEK0775	
3.	MERCEDES ACTROS	0 001 372 006	005 151 50 01	ELEK0222	

24V 6,7kW

					
					
		Pozicija 1	Pozicija 2	Pozicija 3	Pozicija 4
Pozicija	Tip vozila	KBP	OE broj	RAPIDEX broj	
1.	MERCEDES ACTROS	0 001 371 019	005 151 88 01	ELEK0766	
2.	SCANIA SERIJA 4	0 001 371 004	1 332 903	ELEK0776	
3.	SCANIA SERIJA 4	0 001 371 006	1 357 709	ELEK0777	
4.	SCANIA SERIJA 4	0 001 371 008	1 382 290	ELEK0778	

24V 5,4 / 6,6kW

				
Pozicija	Tip vozila	KBP	OE broj	RAPIDEX broj
1.	MAN F90, F2000, TGA, MERCEDES MK, NG, SK	0 001 416 002	51.26201.7125 003 151 45 01	ELEK0392
2.	MAN F90, F2000, TGA, MERCEDES MK, NG, SK	0 001 417 001	51.26201.7110 003 151 46 01	ELEK0782

8.0 PRIBORI



8.0 PRIBORI

8.1	Obeležavajuće table i pribori A.D.R.	648
8.2	Pribor za osiguravanje tereta	664
8.3	Lanci za sneg	666
8.4	Vučne kuke	668
8.5	Grejanje kabine	671

[NAZAD NA GLAVNI SADRŽAJ](#)

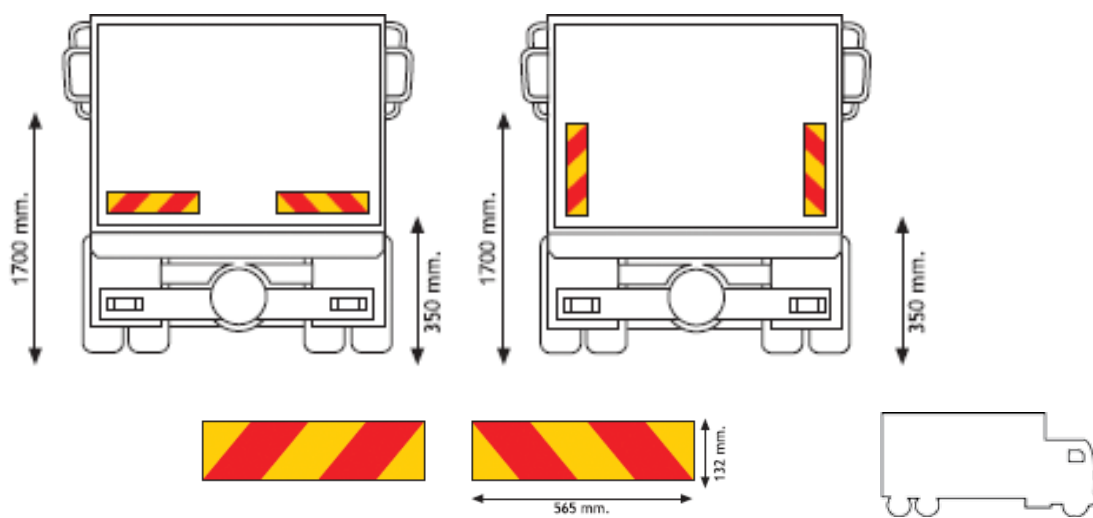
**REFLEKTUJUĆE I FLUOROSCENTNE TABLE ZA KAMIONE
SAGLASNO REGULATIVI ECE 70**

Poz.	Dimenzije (mm)	Opis	Jedinica mere	RAPIDEX broj
1.	565 x 132	Aluminijum	PAR	OPRE0097

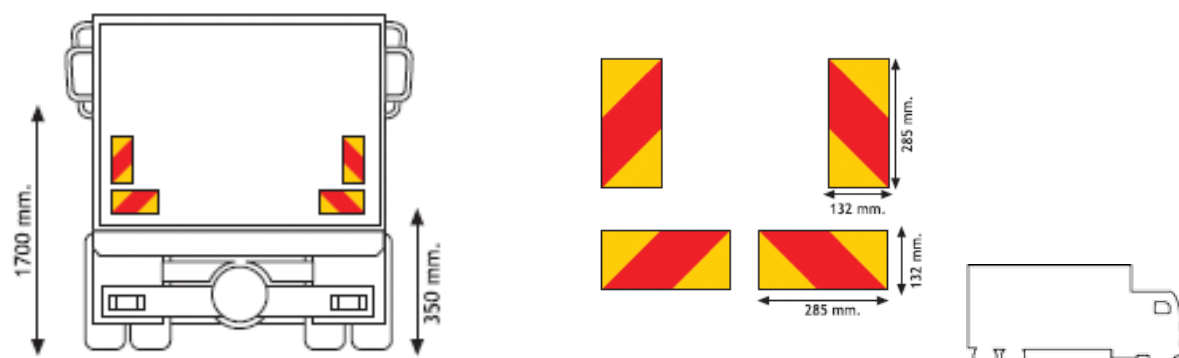

Poz.	Dimenzije (mm)	Opis	Jedinica mere	RAPIDEX broj
2.	285 x 132	Aluminijum	PAR	OPRE0260

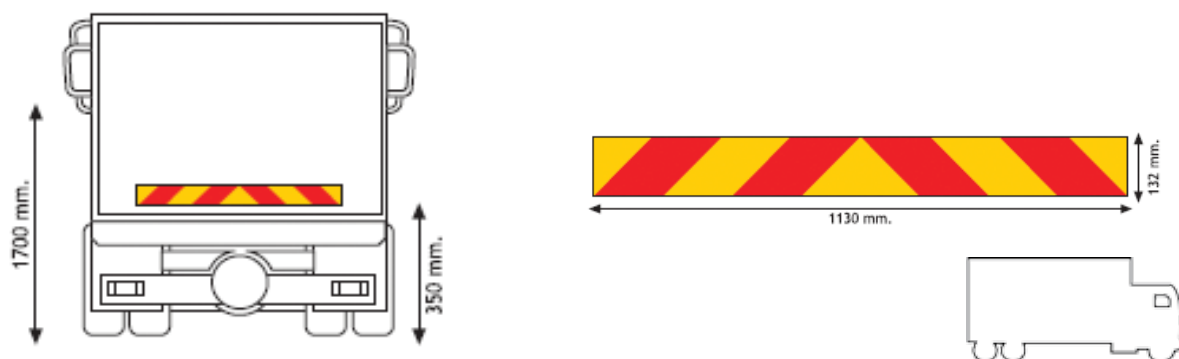

Poz.	Dimenzije (mm)	Opis	Jedinica mere	RAPIDEX broj
3.	1130 x 196	Aluminijum	KOM	OPRE0261

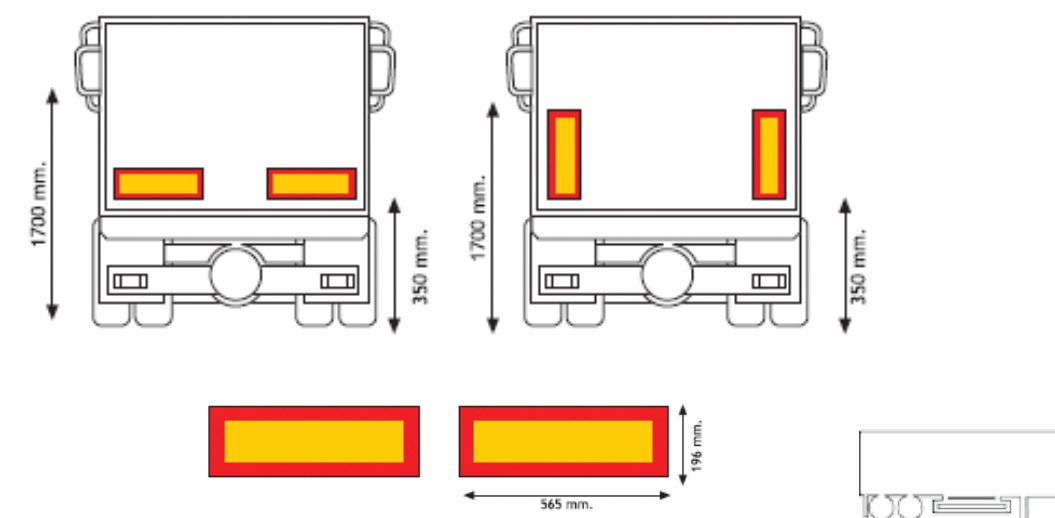
**REFLEKTUJUĆE I FLUOROSCENTNE TABLE ZA KAMIONE
SAGLASNO REGULATIVI ECE 70**

Poz.	Dimenzije (mm)	Opis	Jedinica mere	RAPIDEX broj
1.	565 x 196	Aluminijum	PAR	OPRE0157

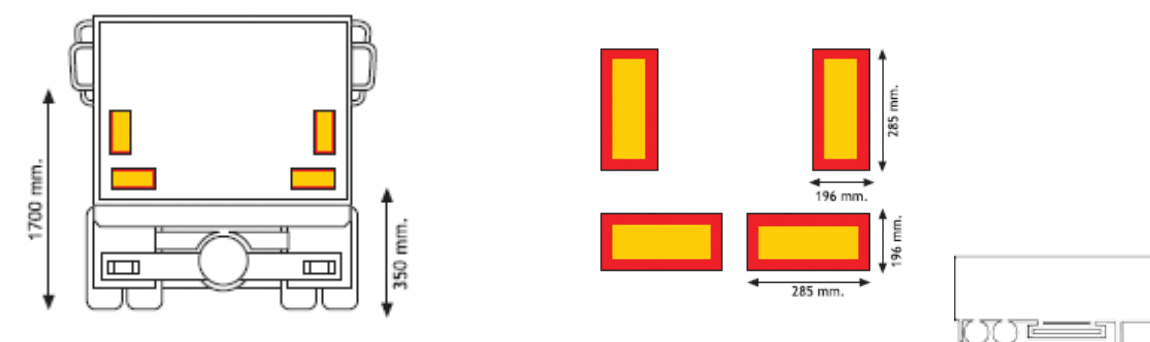

Poz.	Dimenzije (mm)	Materijal	Jedinica mere	RAPIDEX broj
2.	285 x 196	Aluminijum	PAR	OPRE0262

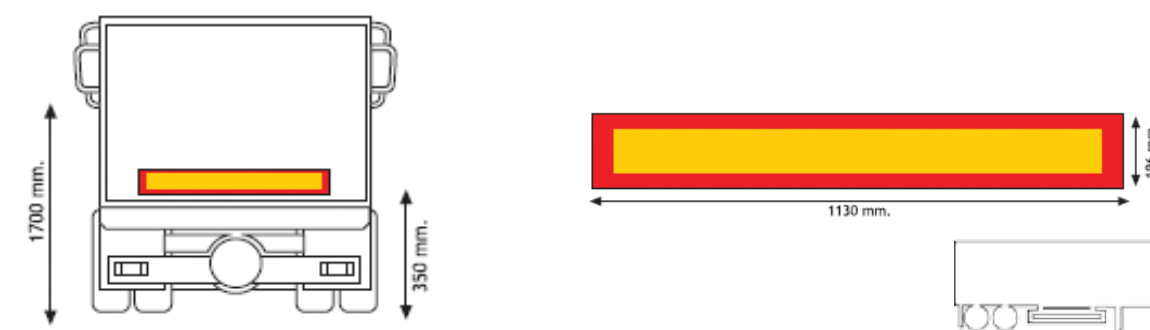

Poz.	Dimenzije (mm)	Opis	Jedinica mere	RAPIDEX broj
3.	1130 x 196	Aluminijum	KOM	OPRE0090

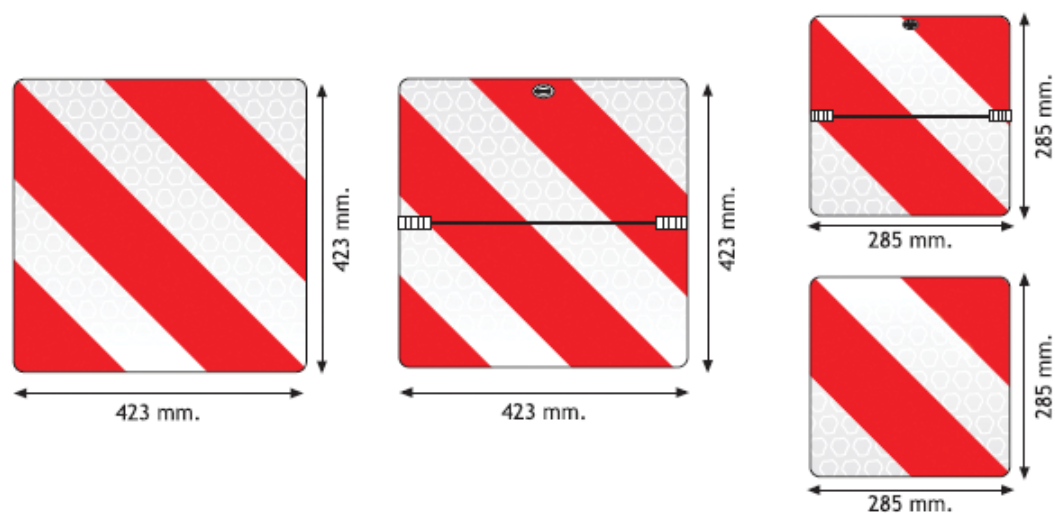
**REFLEKTUJUĆE TABLE ZA PREVOZ TERETA
VAN DOZVOLJENIH GABARITA**

Poz.	Dimenzije (mm)	Opis	Jedinica mere	RAPIDEX broj
1.	423 x 423	Aluminijum / Panel	kom	OPRE0142
2.	423 x 423	Aluminijum / Preklopiva	kom	OPRE0263
3.	285 x 285	Aluminijum / Preklopiva	kom	OPRE0265
4.	285 x 285	Aluminijum / Panel	kom	OPRE0264

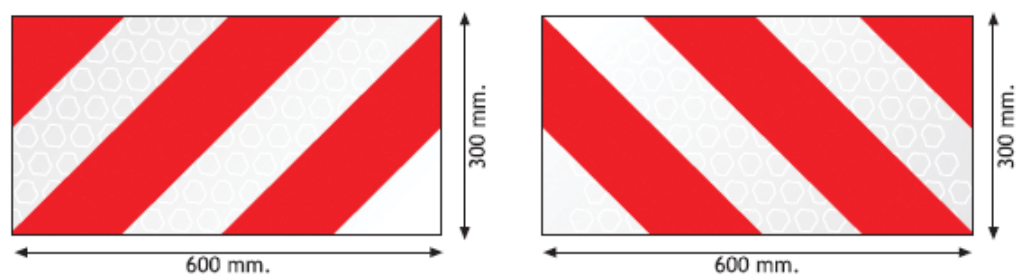

Poz.	Dimenzije (mm)	Opis	Jedinica mere	RAPIDEX broj
5.	600 x 300	Aluminijum / Panel	set	OPRE0266

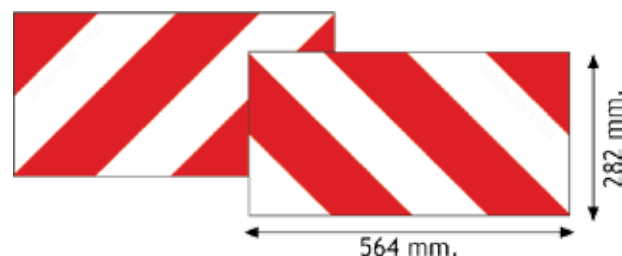

Poz.	Dimenzije (mm)	Opis	Jedinica mere	RAPIDEX broj
6.	564 x 282	Aluminijum / Panel	set	OPRE0267

REFLEKTUJUĆE TABLE OGRANIČENJA BRZINE

Poz.	Dimenzije (mm)	Opis	RAPIDEX broj
1.	Ø 200	Nalepnica	OPRE0268
		Aluminijum	OPRE0269
2.	Ø 200	Nalepnica	OPRE0270
		Aluminijum	OPRE0271
3.	Ø 200	Nalepnica	OPRE0272
		Aluminijum	OPRE0273
4.	Ø 200	Nalepnica	OPRE0274
		Aluminijum	OPRE0275
5.	Ø 200	Nalepnica	OPRE0276
		Aluminijum	OPRE0277
6.	Ø 200	Nalepnica	OPRE0278
		Aluminijum	OPRE0279

OZNAČAVAJUĆE TABLE ZA PREVOZ DECE

Poz.	Dimenzije (mm)	Opis	RAPIDEX broj
1.	400 x 400	Aluminijum	OPRE0280
2.	400 x 400	Aluminijum / Preklopiva - Horizontalno	OPRE0089
3.	400 x 400	Nalepnica	OPRE0282

IDENTIFIKACIONE OZNAKE VOZILA

Poz.	Dimenzije (mm)	Opis	RAPIDEX broj
1.	Ø 200	Aluminijum	OPRE0283
2.	Ø 200	Aluminijum	OPRE0284
3.	Ø 200	Aluminijum	OPRE0285
4.	Ø 200	Aluminijum	OPRE0286
5.	Ø 200	Aluminijum	OPRE0055
6.	Ø 200	Aluminijum	OPRE0056
7.	Ø 200	Aluminijum	OPRE0057



Poz.	Dimenzije (mm)	Opis	RAPIDEX broj
1.	Ø 200	Aluminijum	OPRE0287
2.	Ø 200	Aluminijum	OPRE0288
3.	Ø 200	Aluminijum	OPRE0289



Poz.	Dimenzije (mm)	Opis	RAPIDEX broj
1.	400 x 250	Aluminijum	OPRE0290
2.	400 x 250	Aluminijum / Preklopiva - Horizontalno	OPRE0154
3.	400 x 250	Aluminijum / Preklopiva - Vertikalno	OPRE0291

UPOZORAVAJUĆE TABLE HIDRAULIČNIH ZADNJIH VRATA

Poz.	Opis	RAPIDEX broj
1.	Aluminijumska tabla / desna strana	OPRE0292
2.	Aluminijumska tabla / leva strana	OPRE0293
3.	Aluminijumska tabla sa nosačem / desna strana	OPRE0294
4.	Aluminijumska tabla sa nosačem / leva strana	OPRE0295
5.	Aluminijumske table sa nosačima / desna i leva strana - set	OPRE0296

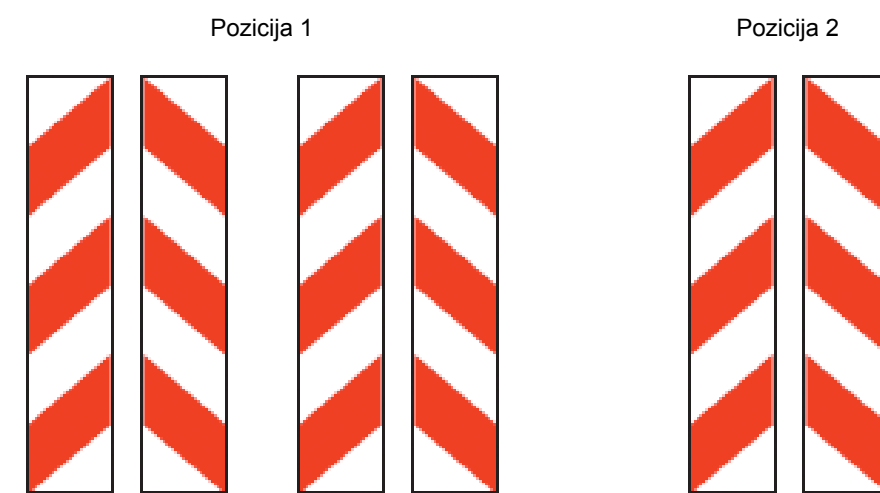
**IDENTIFIKACIONE TABLE ZA VOZILA I KONTEJNERE
SAGLASNO REGULATIVI DIN 67520**

Poz.	Dimenzije (mm)	Opis	RAPIDEX broj
1.	141 x 705	Aluminijum / SET (4 desne + 4 leve table)	OPRE0297
2.	141 x 705	Aluminijum / SET (1 desne + 1 leve table)	OPRE0298

REFLEKTUJUĆE TRAKE ZA VOZILA
SAGLASNO REGULATIVI EEC U.N.104

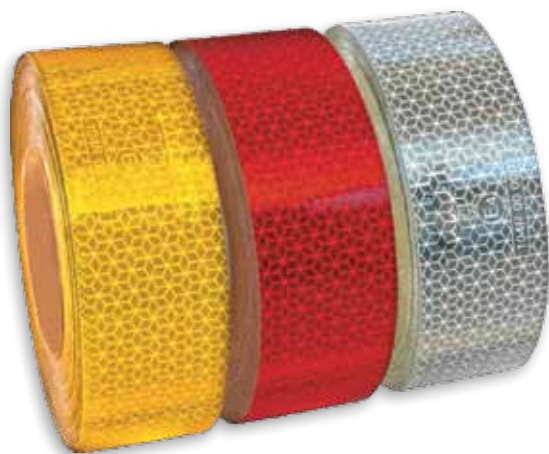
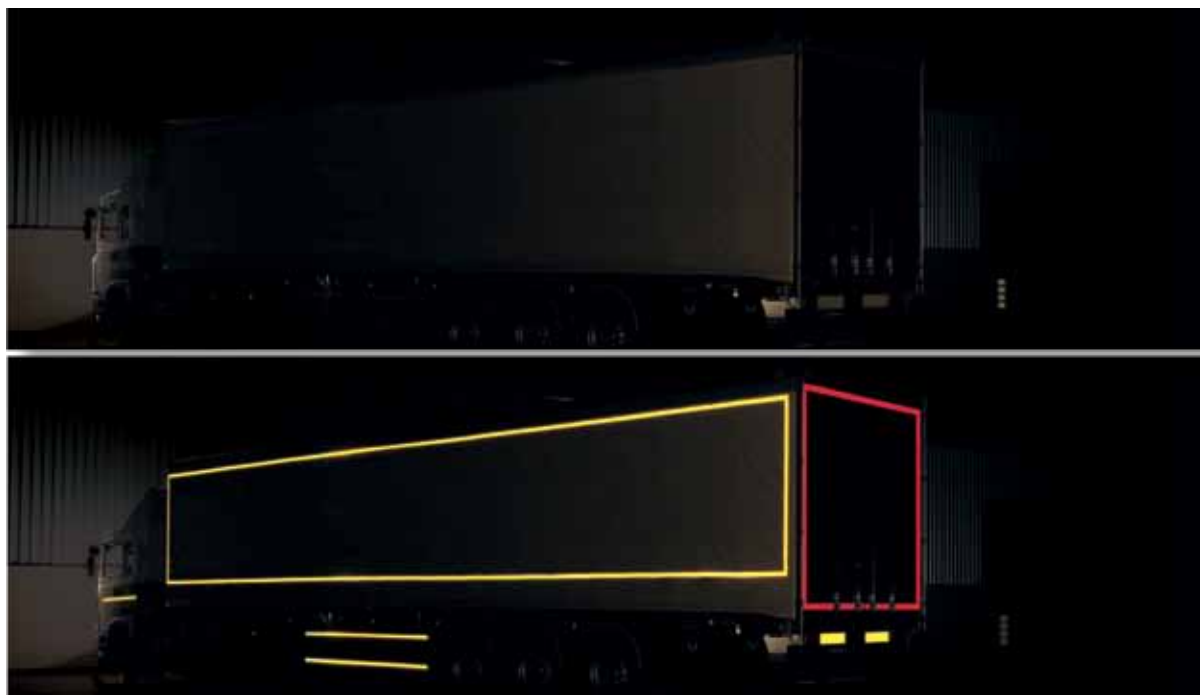

Pozicija 1



Pozicija 2



Pozicija 3

Poz.	Opis	RAPIDEX broj
1.	Reflektujuća traka žute boje 50 mm x 50 m	OPRE0299
2.	Reflektujuća traka crvene boje 50 mm x 50 m	OPRE0300
3.	Reflektujuća traka bele boje 50 mm x 50 m	OPRE0301

REFLEKTUJUĆE TRAKE ZA VOZILA
SAGLASNO REGULATIVI EEC U.N.104

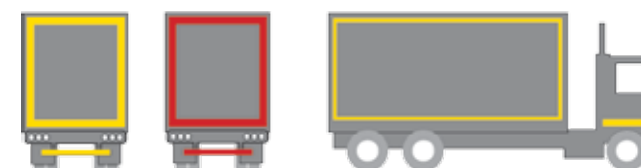
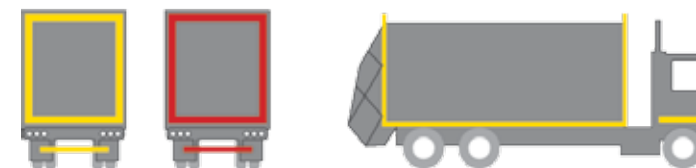
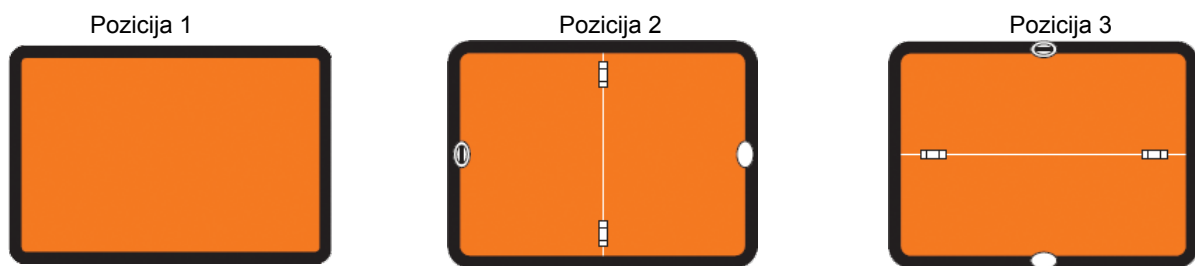
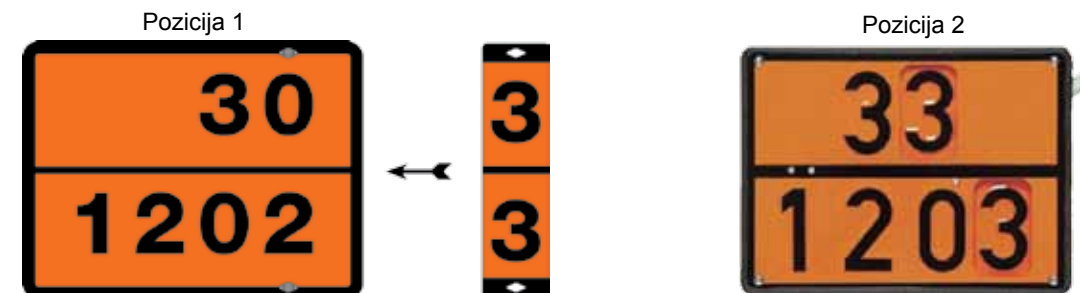

TABLE A.D.R.

Poz.	Dimenzije (mm)	Opis	RAPIDEX broj
1.	400 x 300	Aluminijum	OPRE0153
2.	400 x 300	Aluminijum / Preklopiva - Vertikalno	OPRE0152
3.	400 x 300	Aluminijum / Preklopiva - Horizontalno	OPRE0302



Poz.	Dimenzije (mm)	Opis	RAPIDEX broj
1.	400 x 300	30 - 1202 - Dizel	OPRE0035
2.	400 x 300	33 - 1203 - Benzin	OPRE0036
3.	400 x 300	30 - 1223 - Kerozin	OPRE0037
4.	400 x 300	23 - 1965 - LPG	OPRE0038
5.	400 x 300	23 - 1978 - Propan	OPRE0039
6.	400 x 300	23 - 1971 - Prirodni gas	OPRE0040
7.	400 x 300	23 - 1951 - Tečni argon	OPRE0041
8.	400 x 300	22 - 1977 - Tečni azot	OPRE0042
9.	400 x 300	22 - 2187 - Tečni CO ₂	OPRE0043
1.	400 x 300	223 - 1966 - Tečni vodonik	OPRE0044
11.	400 x 300	225 - 1073 - Tečni kiseonik	OPRE0045
12.	400 x 300	263 - 1040 - Etilenoksid	OPRE0046
13.	400 x 300	23 - 1011 - Butan	OPRE0047
14.	400 x 300	223 - 1038 - Tečni etilen	OPRE0048
15.	400 x 300	223 - 1972 - Tečni prirodni gas	OPRE0049
16.	400 x 300	30 - 1202 - Dizel / Preklopiva - Horizontalno	OPRE0052
17.	400 x 300	33 - 1203 - Benzin / Preklopiva - Horizontalno	OPRE0053
18.	400 x 300	30 - 1202 - Dizel / Preklopiva - Vertikalno	OPRE0303
19.	400 x 300	33 - 1203 - Benzin / Preklopiva - Vertikalno	OPRE0304

TABLE A.D.R.

Poz.	Dimenzije (mm)	Opis	RAPIDEX broj
1.	400 x 300	Izmenljiva tabla za dizel i benzin	OPRE0305
2.	400 x 300	Izmenljiva tabla sa ručicom za dizel i benzin	OPRE0054

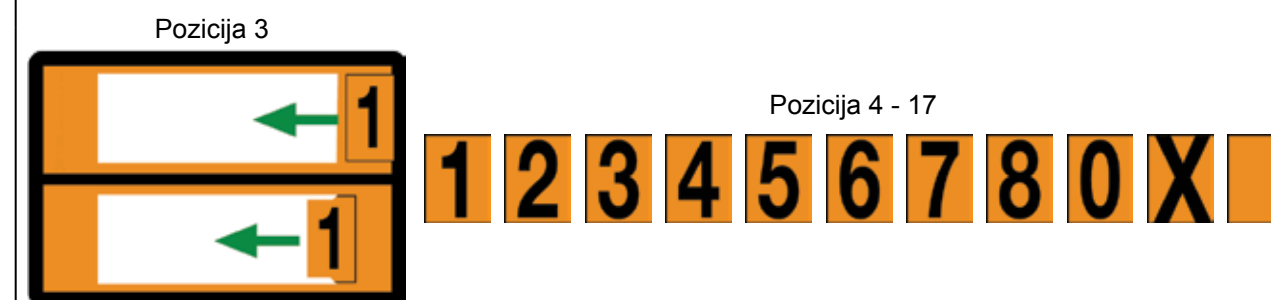

Poz.	Dimenzije (mm)	Opis	RAPIDEX broj
3.	400 x 300	Tabla(nosač) A.D.R. za različite trasporte	OPRE0034
4.	70 x 118	Set od 10 simbola za tablu A.D.R.: 0 - 2 kom.; 1 - 1 kom.; 2 - 2 kom.; 3 - 3 kom.; Prazno polje - 2 kom.	OPRE0050
5.	70 x 118	Set od 12 simbola za tablu A.D.R.: 1 - 1 kom.; 2 - 1 kom.; 3 - 2 kom.; 5 - 1 kom.; 6 - 3 kom.; 7 - 1 kom.; 8 - 1 kom.; Prazno polje - 2 komada	OPRE0051
6.	70 x 118	Set od 33 simbola za tablu A.D.R.: 0 - 3 kom.; 1 - 3 kom.; 2 - 3 kom.; 3 - 4 kom.; 4 - 2 kom.; 5 - 3 kom.; 6 - 5 kom.; 7 - 2 kom.; 8 - 3 kom.; X - 2 kom.; Prazno polje - 3 komada	OPRE0306
7.	70 x 118	Broj 1 za tablu A.D.R.	OPRE0307
8.	70 x 118	Broj 2 za tablu A.D.R.	OPRE0308
9.	70 x 118	Broj 3 za tablu A.D.R.	OPRE0309
10.	70 x 118	Broj 4 za tablu A.D.R.	OPRE0310
11.	70 x 118	Broj 5 za tablu A.D.R.	OPRE0311
12.	70 x 118	Broj 6 za tablu A.D.R.	OPRE0312
13.	70 x 118	Broj 7 za tablu A.D.R.	OPRE0313
14.	70 x 118	Broj 8 za tablu A.D.R.	OPRE0314
15.	70 x 118	Broj 0 za tablu A.D.R.	OPRE0315
16.	70 x 118	Simbol X za tablu A.D.R.	OPRE0316
17.	70 x 118	Prazno polje za tablu A.D.R.	OPRE0317

TABLE ZA OZNAČAVANJE OPASNIH MATERIJIA 300 x 300 mm

	Klasa 1.1, 1.2, 1.3 RAPIDEX broj: OPRE0318		Klasa 1.4 RAPIDEX broj: OPRE0320		Klasa 1.5 RAPIDEX broj: OPRE0319
	Klasa 1.6 RAPIDEX broj: OPRE0321		Klasa 2 RAPIDEX broj: OPRE0322		Klasa 2 RAPIDEX broj: OPRE0323
	Klasa 2 RAPIDEX broj: OPRE0324		Klasa 3 RAPIDEX broj: OPRE0340		Klasa 4.1 RAPIDEX broj: OPRE0325
	Klasa 4.2 RAPIDEX broj: OPRE0326		Klasa 4.3 RAPIDEX broj: OPRE0327		Klasa 5 RAPIDEX broj: OPRE0328
	Klasa 5.1 RAPIDEX broj: OPRE0329		Klasa 5.2 RAPIDEX broj: OPRE0330		Klasa 6.1 RAPIDEX broj: OPRE0331
	Klasa 6.2 RAPIDEX broj: OPRE0332		Klasa 7/A RAPIDEX broj: OPRE0333		Klasa 7/B RAPIDEX broj: OPRE0334
	Klasa 7/C RAPIDEX broj: OPRE0335		Klasa 7 RAPIDEX broj: OPRE0336		Klasa 8 RAPIDEX broj: OPRE0337
	Klasa 9 RAPIDEX broj: OPRE0338		Klasa 9 RAPIDEX broj: OPRE0339		

TABLE ZA OZNAČAVANJE OPASNIH MATERIJIA

KLASA	OPASNE MATERIJIE
1	Eksplozivne materije i predmeti punjeni eksplozivnim materijama
2	Zbijeni gasovi, gasovi pretvoreni u tečnost i gasovi rastvoreni pod pritiskom
3	Zapaljive tečnosti
4.1	Zapaljive čvrste materije
4.2	Materije sklone samopaljenju
4.3	Materije koje u dodiru sa vodom razvijaju zapaljive gasove
5.1	Oksidirajuće materije
5.2	Organski peroksidi
6.1	Otrovi
6.2	Gadne i zarazne materije
7	Radioaktivne materije
8	Korozivne (nagrizajuće) materije
9	Ostale opasne materije.

KUTIJA ZA PROTIVPOŽARNI APARAT



RAPIDEX broj:
OPRE0065

TEHNIČKE KARAKTERISTIKE:



Spoljašnje mere: 277 x 277 x 635 mm

Unutrašnje mere: 140 ÷ 185 mm

Kapacitet: 6 kg

Ostale karakteristike: vatrootporna, voodootporna i otporna na vibracije

PRIBORI A.D.R.

Slika	Opis	RAPIDEX broj
	Torba A.D.R. Sadrži: PVC rukavice, sredstvo za ispiranje očiju, zaštitne naočare, kompletnu masku, filter zaštitne maske i kecelju	OPRE0031
	Torba A.D.R. Sadrži: PVC rukavice, sredstvo za ispiranje očiju, zaštitne naočare, polumasku, filter zaštitne maske i kecelju	OPRE0070

PRIBORI A.D.R.

Slika	Opis	RAPIDEX broj
	Poklopac za kanalizacioni otvor 1000 x 1000 mm	OPRE0341
	Poklopac za kanalizacioni otvor 2000 x 3000 mm	OPRE0342
	Absorbujući granulat	OPRE0343
	Zaštitno odelo	OPRE0344
	Zaštitna šlem	OPRE0345
	Cipele	OPRE0346

PRIBORI A.D.R.		
Slika	Opis	RAPIDEX broj
	Reflektujući prsluk	OPRE0147
	Trougao upozorenja	OPRE0100
	Čunj	OPRE0347
	Čunj - reflektujući	OPRE0348
	Upozoravajuća lampa	OPRE0349
	Baterijska lampa	OPRE0350
	Preklapajuća lopata	OPRE0128
	Prva pomoć	OPRE0351

OPREMA		
Slika	Opis	RAPIDEX broj
	GUMENE ZAVESE	
	350 x 300 mm	OPRE0165
	500 x 300 mm	OPRE0124
	600 x 300 mm	OPRE0125
	650 x 400 mm	OPRE0232
	KLOCNA TOČKA metalna	
	160 mm 200 mm	OPRE0359 OPRE0183
	KLOCNA TOČKA plastična	
	160 mm 200 mm	OPRE0235 OPRE0182
	DIZALICA	
	8 t	OPRE0360
	12 t	OPRE0361
	16 t	OPRE0362
	20 t	OPRE0363
	RUDA ZA VUČU	
		OPRE0194
	PRIBOR ZA ČIŠĆENJE KABINE VOZAČA	OPRE0029

PRIBOR ZA OSIGURAVANJE TERETA

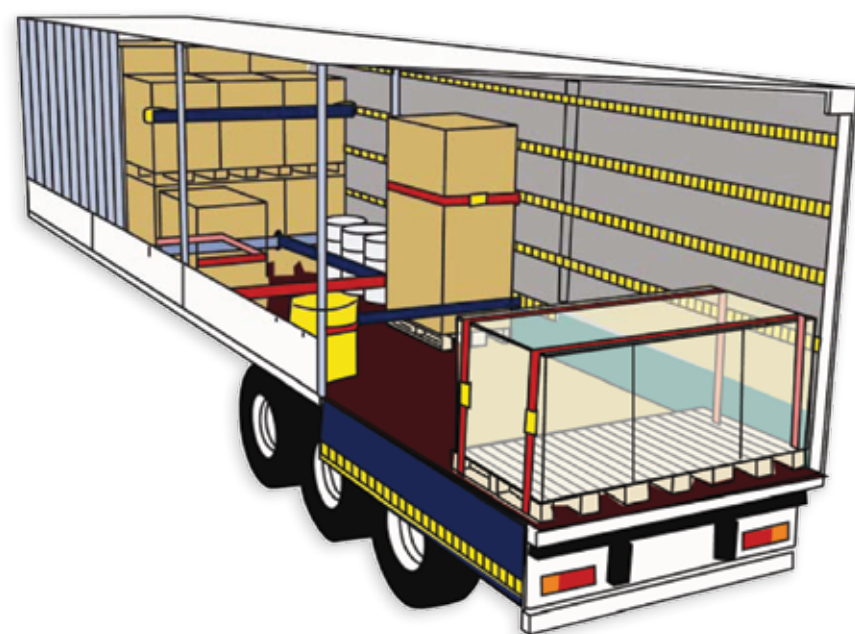
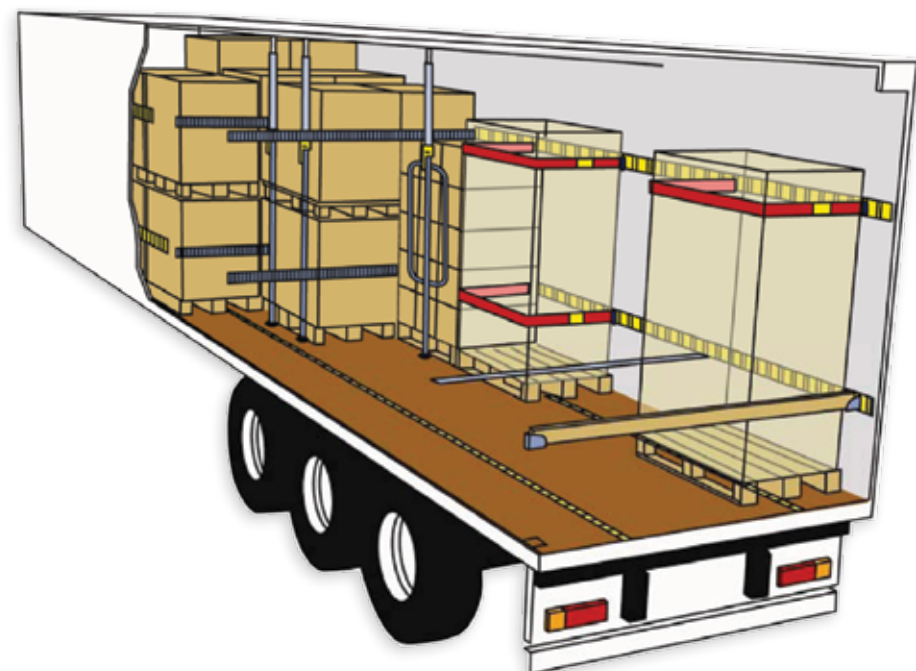

PRIBOR ZA OSIGURAVANJE TERETA



Poz.	Naziv	Dimenzije	Nosivost (daN)		RAPIDEX broj
1.	Traka za vezivanje tereta KPL	8 m x 50 mm	2500	5000	OPRE0185
2.	Traka za vezivanje tereta KPL	10 m x 50 mm	2500	5000	OPRE0184
3.	Traka za vezivanje tereta KPL	12 m x 50 mm	2500	5000	OPRE0170
4.	Traka za vezivanje tereta	8 m x 50 mm	2500	5000	OPRE0010
5.	Traka za vezivanje tereta	10 m x 50 mm	2500	5000	OPRE0001
6.	Traka za vezivanje tereta	12 m x 50 mm	2500	5000	OPRE0352
7.	Štitnik robe	180 x 140 x 150 mm			OPRE0033



Poz.	Naziv	Dimenzije		RAPIDEX broj
1.	Letva ADR - aluminijum	21 - 36 mm	2400 - 2700 mm	OPRE0132



Poz.	Naziv	Dimenzije		RAPIDEX broj
1.	Držać - aluminijum	Ø42 mm	2100 - 2470 mm	OPRE0353
2.	Držać - aluminijum	Ø38 mm	2260 - 2630 mm	OPRE0133
3.	Držać - aluminijum	Ø42 mm	2350 - 2720 mm	OPRE0134

8.3 LANCI ZA SNEG

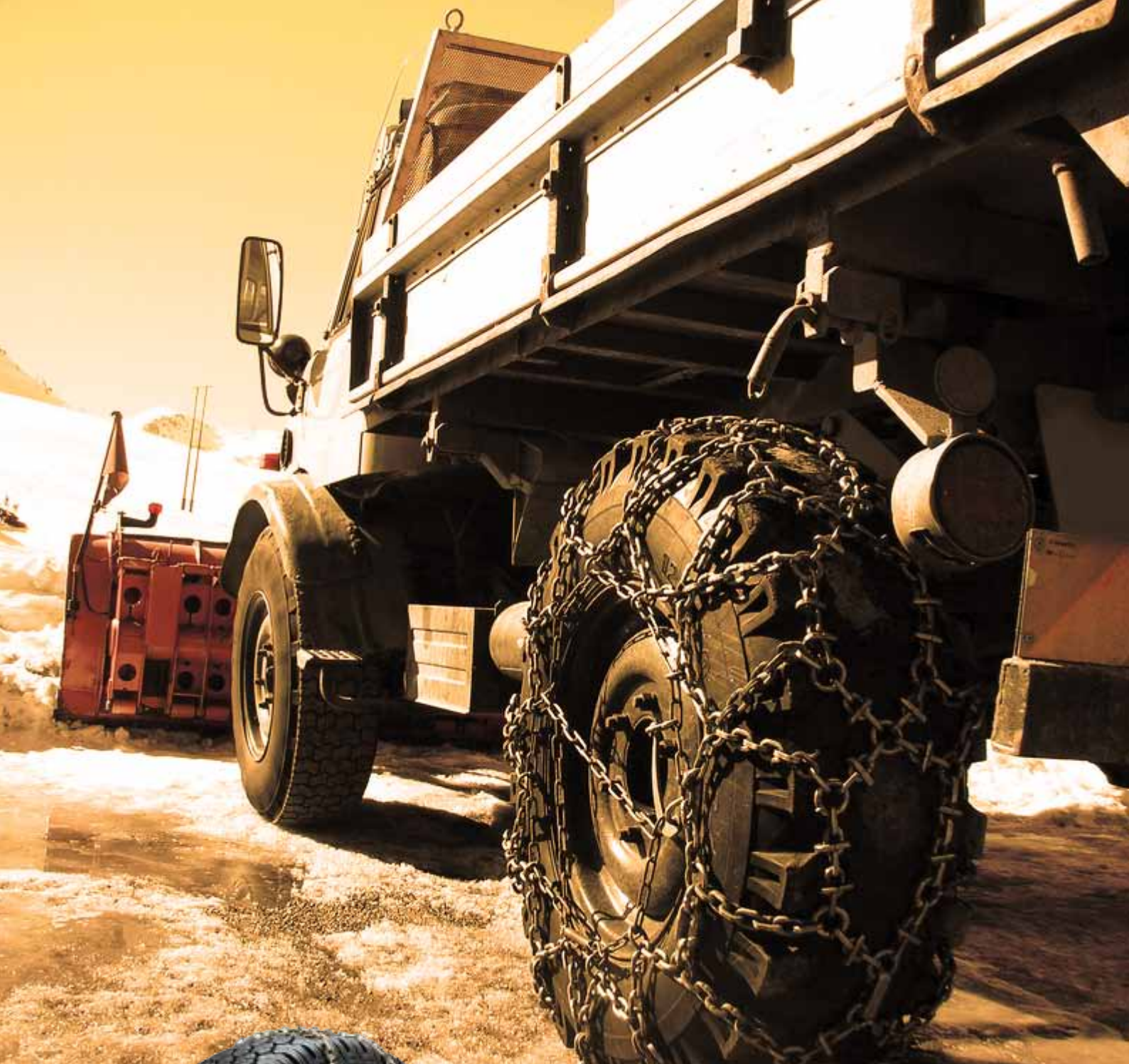

JEDNODELNI LANCI ZA SNEG

Poz.	Primena			RAPIDEX broj
1.	225/70 R15 225/75 R15 235/75 R15 255/75 R15 265/70 R15	225/75 R16 235/70 R16 255/70 R16 7,50 R16	215/70 R17,5 225/75 R17,5 235/75 R17,5 8,00 R17,5 8,50 R17,5	OPRE0084
2.	9,00 R20	275/70 R22,5 295/70 R22,5 295/75 R22,5 305/70 R22,5		OPRE0058
3.	10,00 R20	275/80 R22,5 315/60 R22,5 11,00 R22,5		OPRE0354
4.	10,50 R20 11,00 R20 12,50 R20	295/80 R22,5 315/70 R22,5 315/80 R22,5 12,00 R22,5		OPRE0355
5.	365/80 R20 12,00 R20 14,50 R20	385/65 R22,5 12,00 R22,5 13,00 R22,5		OPRE0356

TRODELNI LANCI ZA SNEG

Poz.	Primena			RAPIDEX broj
1.	205/75 R17,5 215/75 R17,5 225/75 R17,5 235/75 R17,5 7,00 R17,5 8,00 R17,5 8,50 R17,5 9,00 R17,5	7,00 R19,5 8,00 R19,5	6,50 R20	OPRE0357
2.	8,25 R17	245/70 R19,5 265/70 R19,5 275/70 R19,5 285/70 R19,5 9,00 R19,5 9,50 R19,5	7,50 R20 8,25 R20	225/70 R22,5 8,00 R22,5 9,00 R22,5 OPRE0112
3.	305/70 R19,5	9,00 R20	275/70 R22,5 295/70 R22,5 295/60 R22,5 305/60 R22,5 10,00 R22,5	9,50 R24 OPRE0358
4.	10,00 R20 11,00 R20 12,00 R20 12,5 R20 12/80 R20 13/80 R20	11,00 R22	11,00 R22,50 12,00 R22,5 13,00 R22,5 12/80 R22,5 275/80 R22,5 295/80 R22,5 315/80 R22,5 315/75 R22,5 305/70 R22,5 315/70 R22,5 -315/60 R22,5	11.2 R24 305/75 R24,5 315/75 R24,5 OPRE0108

VUČNA KUKA AUTOMATSKA TIP 5055 A, DIN 74053, ISO 1102. D-50

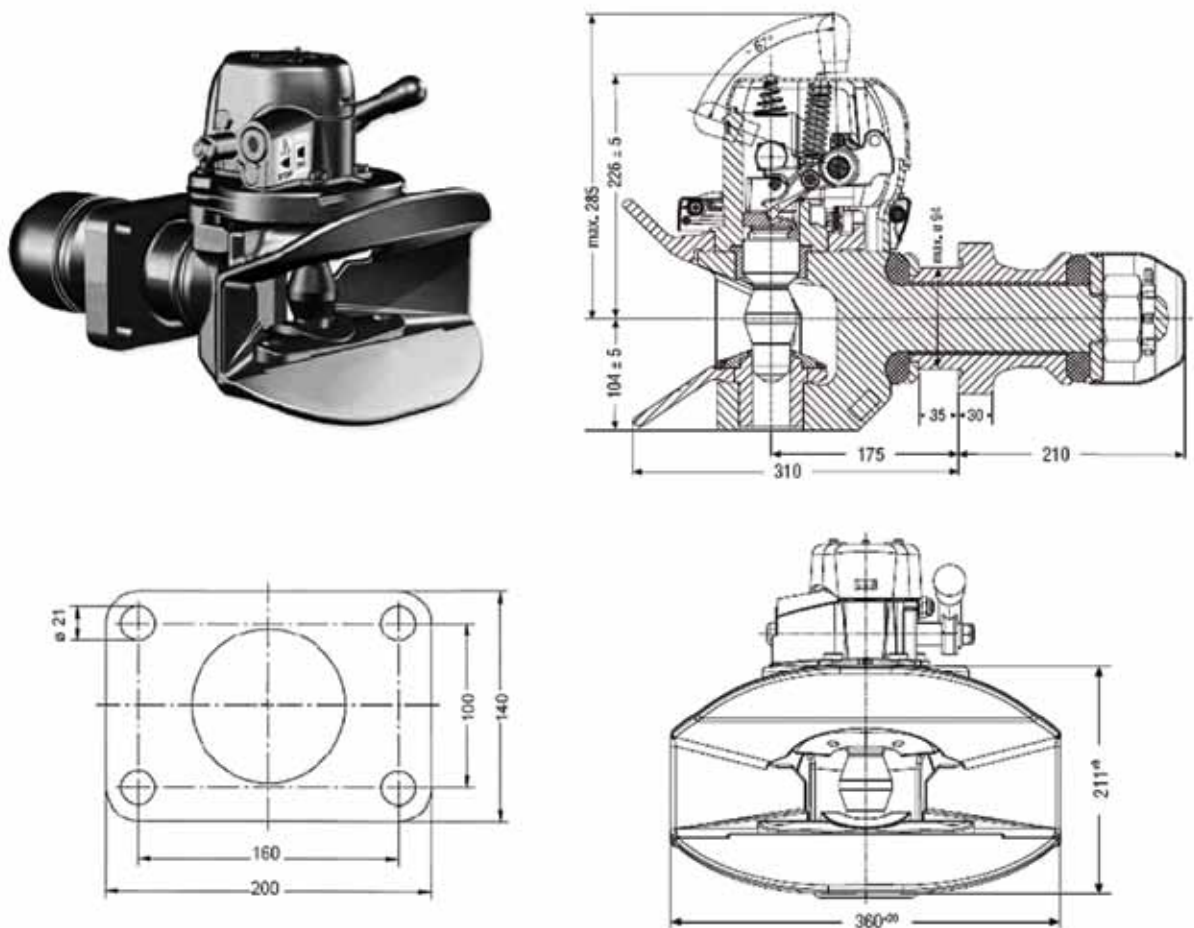

Tehničke karakteristike	Naziv	KBP	RAPIDEX broj
D = 200 kN DC = 135 kN V = 75/63 kN m = 50 kg	VUČNA KUKA	14 996 305	KARO0586
	GORNJA ČAURA	14 995 463	OPRE0237
	DONJA ČAURA	14 991 239	OPRE0236
	STOŽER	14 991 279	OPRE0238
	ZAŠTITNI LIM	14 991 255	OPRE0245

VUČNA KUKA AUTOMATSKA TIP 2045 G/145 G/150, DIN 74054, ISO 8755

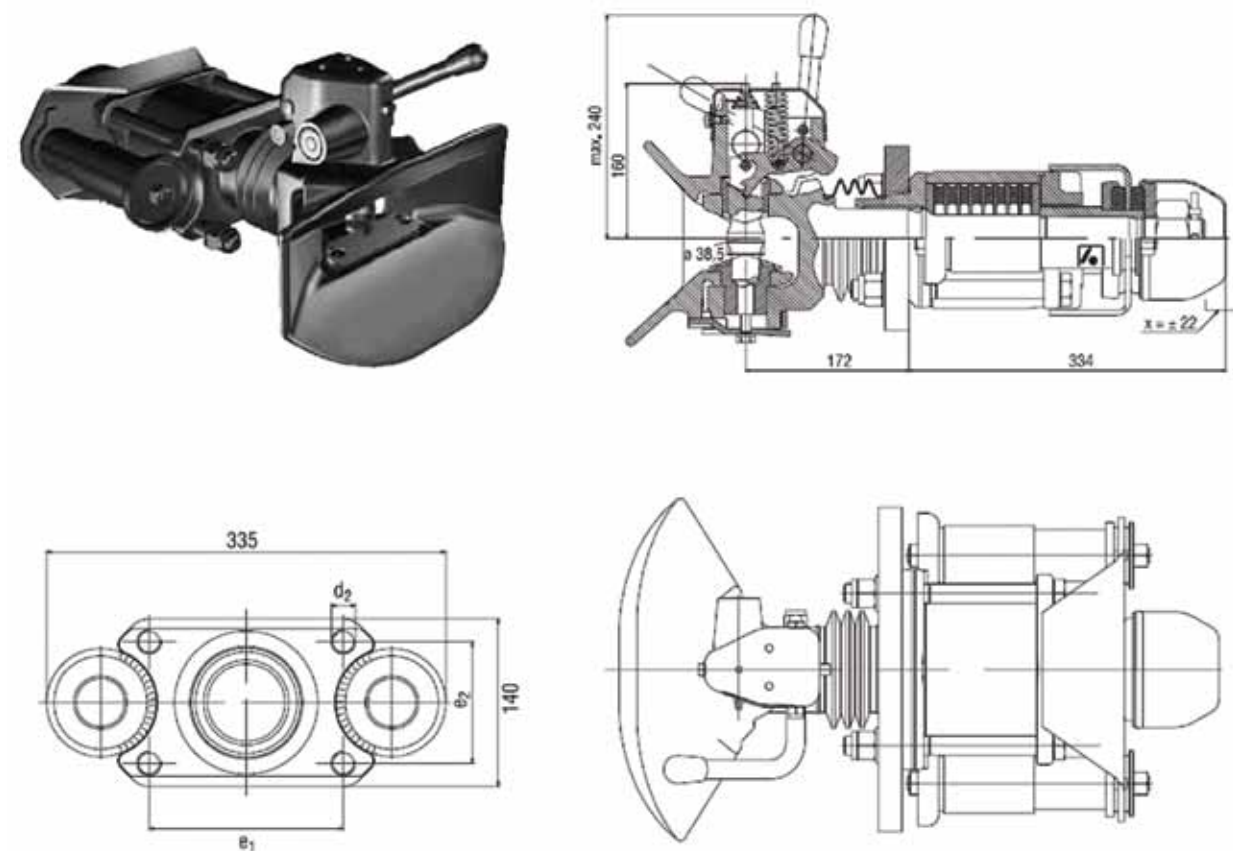

Tehničke karakteristike	Naziv	KBP	RAPIDEX broj
D = 100 kN G/145 D = 136 kN G/136 E1-G/145-140, G/150-160 E2-G/145-80, G/150-100	VUČNA KUKA	G/145 14 995 435	KARO0587
		G/150 14 995 447	KARO0651
	GORNJA ČAURA	6 997 899	OPRE0241
	DONJA ČAURA	6 997 880	OPRE0243
	STOŽER	12 991 452	OPRE0239

VUČNA KUKA AUTOMATSKA TIP 92/CX, DIN 74053, ISO 1102 D 50

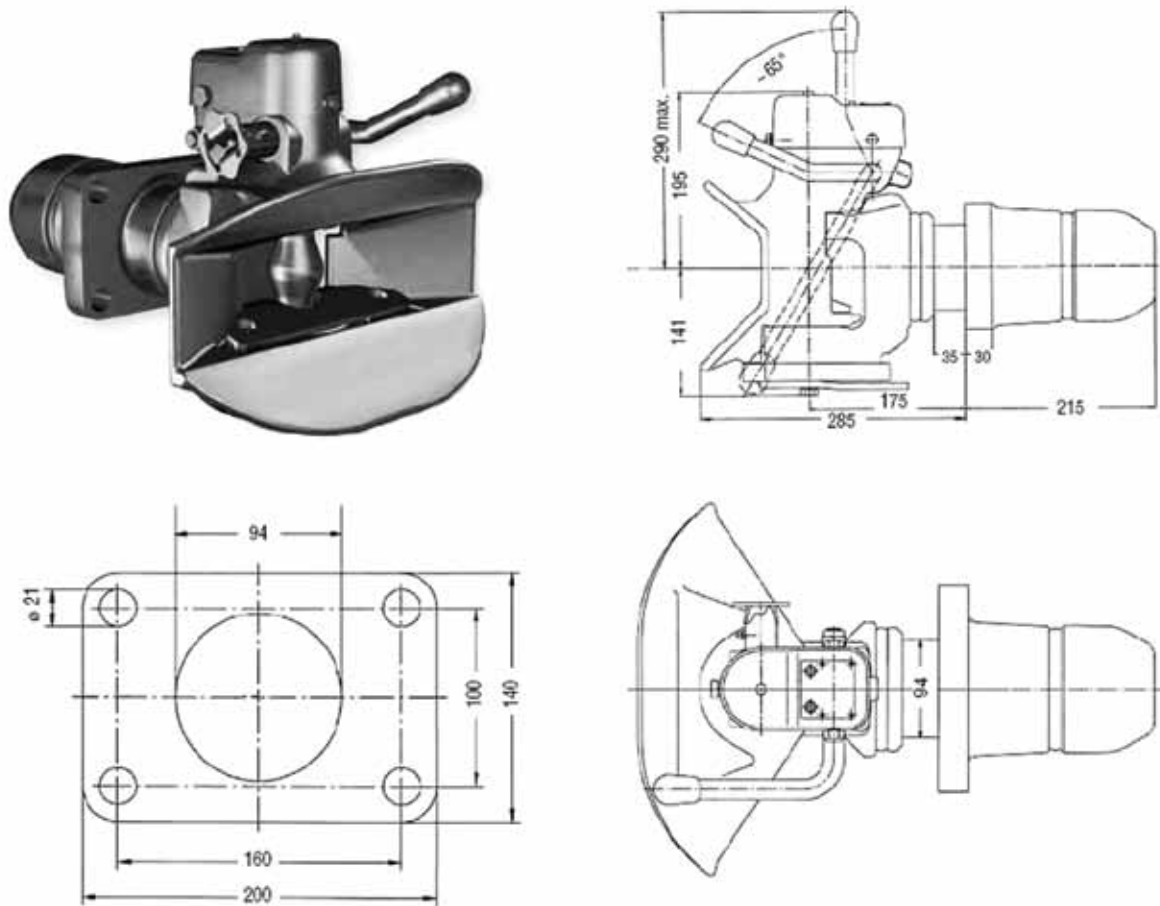

Tehničke karakteristike	Naziv	KBP	RAPIDEX broj
D = 190 kN DC = 130 kN V = 75 kN m = 50 kg	VUČNA KUKA	13 997 020	KARO0588
	GORNJA ČAURA	7 998 210	OPRE0242
	DONJA ČAURA	7 998 252	OPRE0244
	STOŽER	13 991 460	OPRE0240

AIR TOP 2000S



RAPIDEX broj:
HLA00182

Napon (V)	Snaga (W)	Potrošnja goriva (l/h)	Potrošnja energije (W)	Dimenzije (mm)	Težina uređaja (kg)
24	0,9 - 2,0	0,12 - 0,24	14 - 29	311 x 120 x 121	2,6

AIRTRONIC D2



RAPIDEX broj:
HLA00185

	W	2200	1800	1200	850
Kapacitet grejanja	W	2200	1800	1200	850
Protok toplog vazduha	kg/h	105	90	60	40
Potrošnja energije	W	34	22	12	8
Potrošnja goriva	l/h	0,28	0,23	0,15	0,1
Dimenzije uređaja	mm	310 x 115 x 122			
Težina uređaja	kg	2,7			

AIRTRONIC D4 PLUS



RAPIDEX broj:
HLA00186

	W	4000	3000	2000	900
Kapacitet grejanja	W	4000	3000	2000	900
Protok toplog vazduha	kg/h	185	140	100	55
Potrošnja energije	W	55	30	16	7
Potrošnja goriva	l/h	0,51	0,38	0,25	0,11
Dimenzije uređaja	mm	376 x 140 x 150			
Težina uređaja	kg	4,5			



NOTES

A series of 25 horizontal blue lines for writing, spaced evenly down the page.

NOTES



A series of 25 horizontal blue lines for writing, spaced evenly down the page.



NOTES



NOTES



NOTES

Lined writing area for page 678.



NOTES

Lined writing area for page 679.



e-mail: office@rapidex.co.rs
www.rapidex.co.rs

Novi Sad

Novosadski put 160,
tel/fax. 021/6510-521, 6510-522, 6510-523,
064/824-88-00

Beograd

Veternička 10
tel: 011/3691-365
064/824-88-04

Loznica

Dositeja Obradovića 70
tel. 015/877-883
064/824-88-10

Novi Pazar

Save Kovačevića 300
tel. 020/315-156
064/824-88-24

Čačak

Konjevići BB
tel. 032/459-199
064/824-88-26

Banja Luka

Predstavništvo "RAPIDO"
Nikole Pašića BB
tel. 00387-51/584-544
fax. 00387-51/584-606

